

THIS DRAWING IS UNPUBLISHED.  
 DIFFUSION RESTREINTE AMP  
 © COPYRIGHT BY TYCO ELECTRONICS CORPORATION.  
 ALL RIGHTS RESERVED.  
 TOUS DROITS RESERVES.

LOC	DIST	REVISIONS				
P	LTR	DESCRIPTION MODIFICATIONS	DATE	DWN DESS.	APVD APP.	
F	7	A	MODIFICATION INTERFACE PC	27-MAI-98	JLQ	-
		B	SUPPRESSION /-2 AND /-4	11-SEP-98	JLQ	-
		C	CONTACTS COTE CI A 2.9	16-DEC-98	JLQ	-
		D	CODING PIN ON PCB FOR -3	10-JAN-01	JLQ	-
		E	ADD NEWS PNS: 953363-2/-4	29-AUG-06	NT.N	J.L
		F	ADD NEW PN 1-953363-3	22-NOV-06	NT.N	J.L

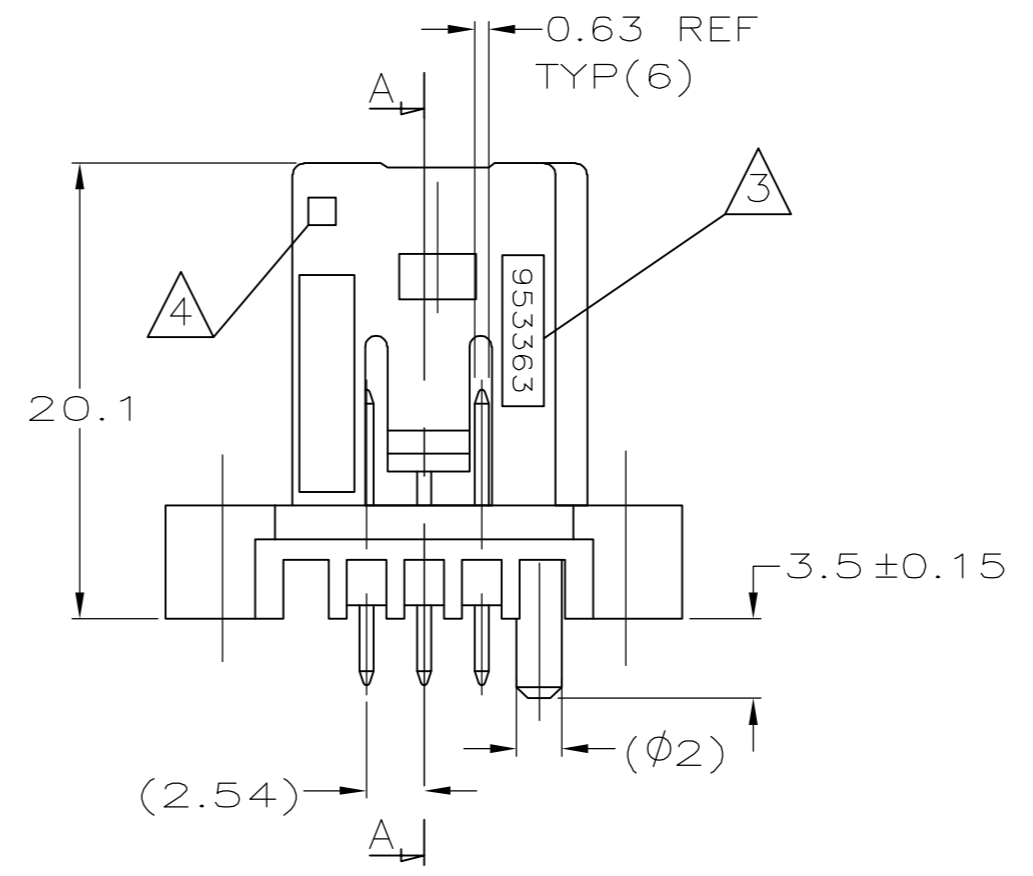
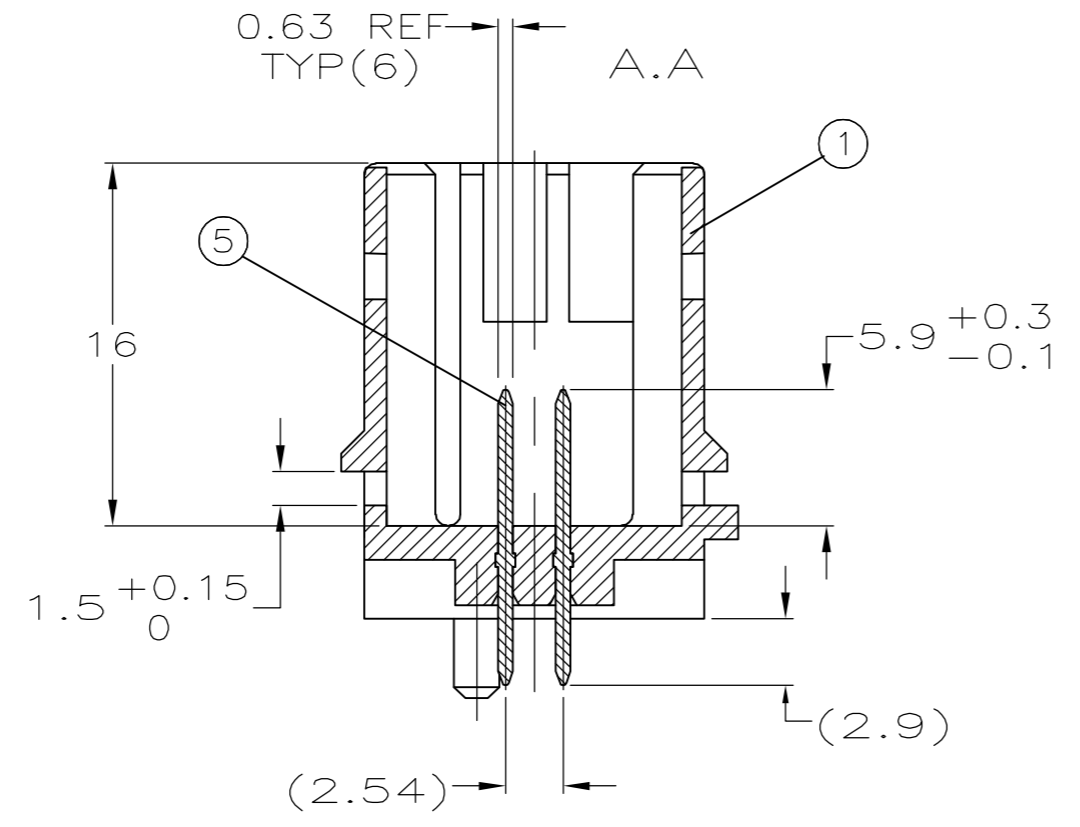
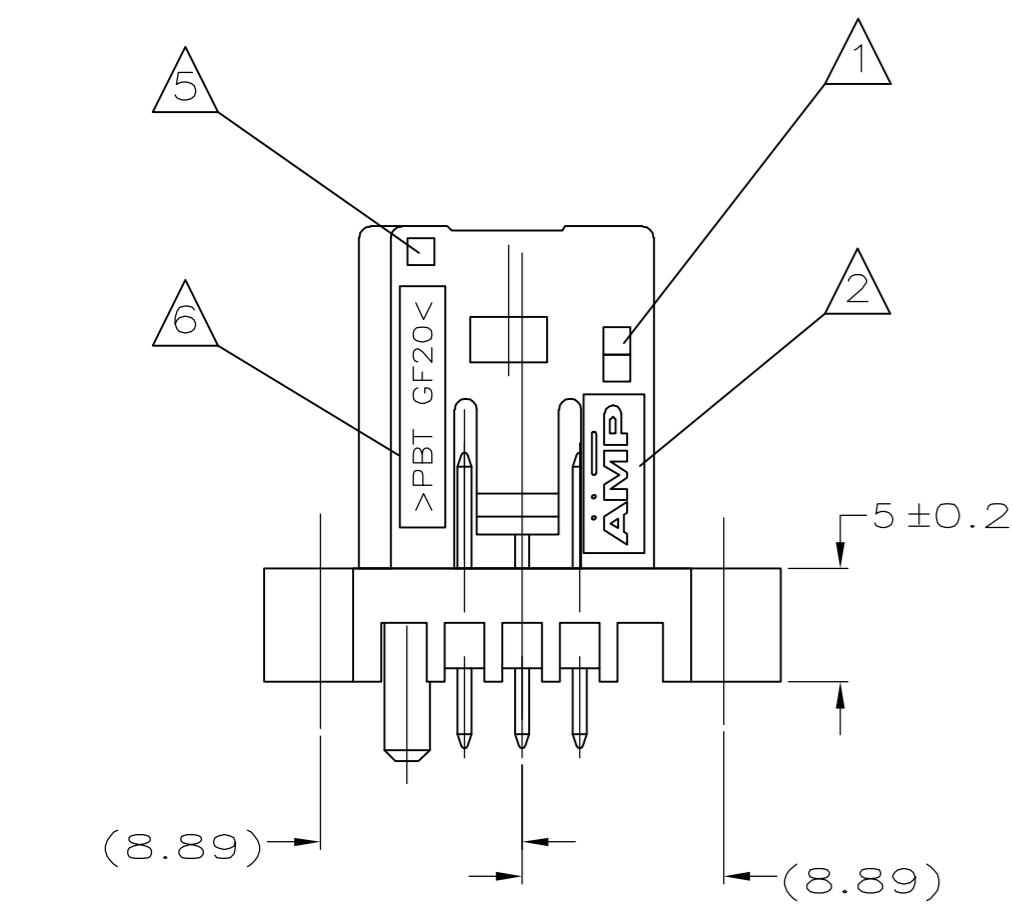

NOTES:

- ① DATE CODE
- ② LOGO D'AMP
- ③ REFERENCE DU PRODUIT ASSEMBLE
- ④ N° D'EMPREINTE DU MOULE
- ⑤ REVISION DU MOULE
- ⑥ MATIERE

DETROMPAGES / CODINGS  
 IMPLANTATION CI / PCB DETAILS  
 VUE DE DESSUS / VIEW FROM TOP

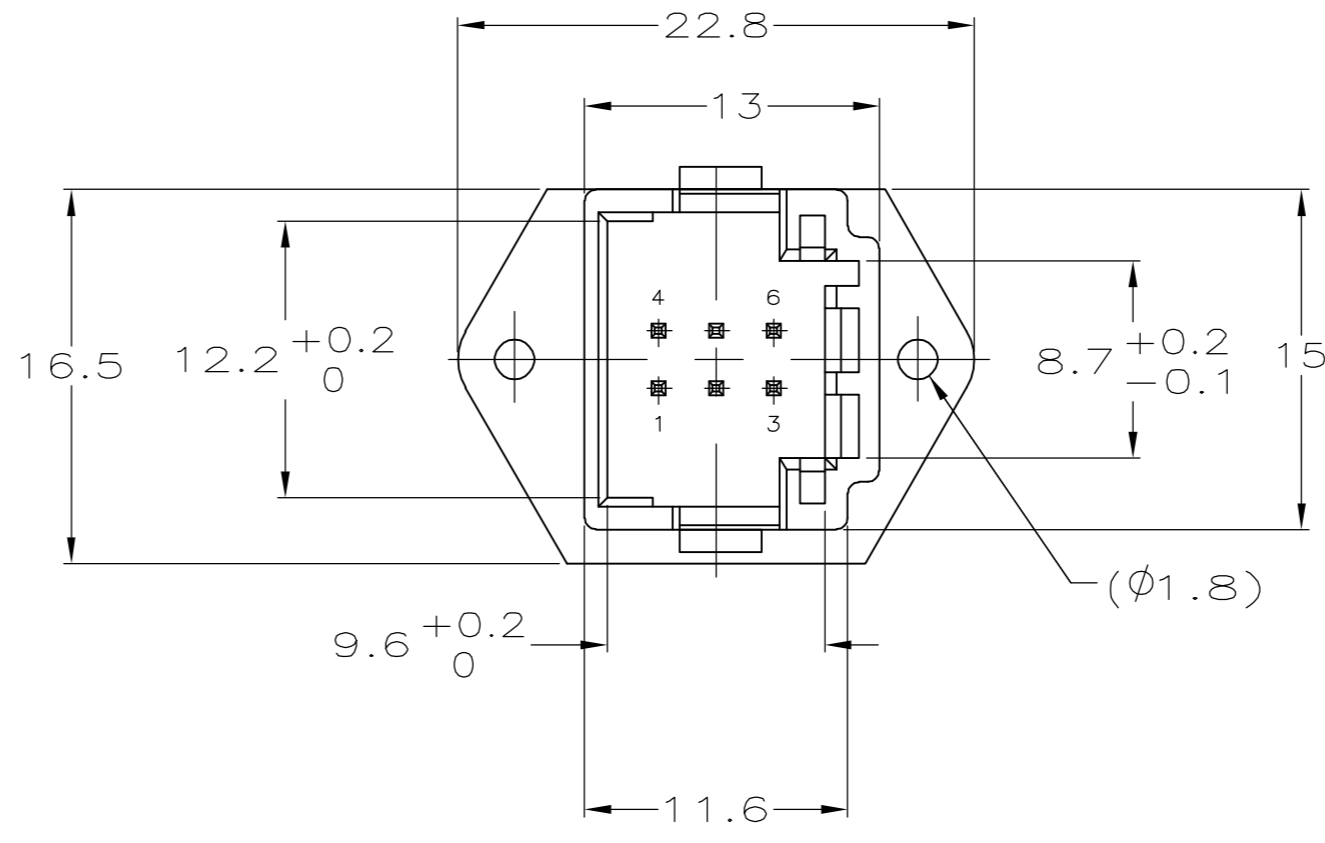
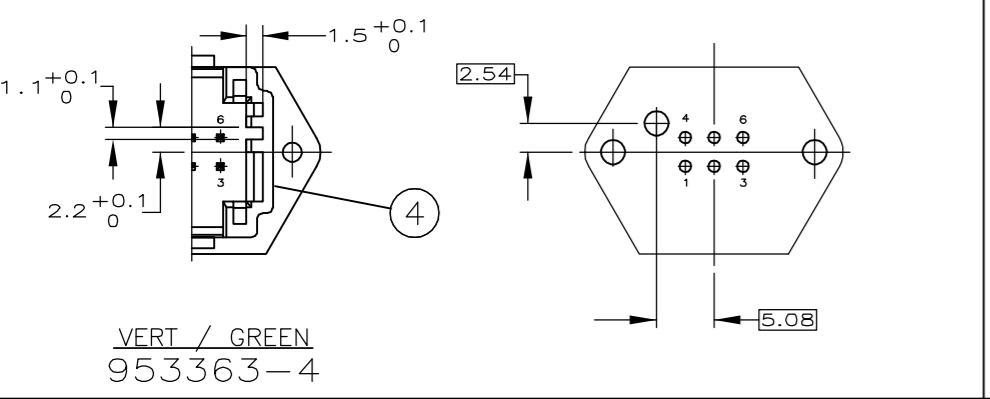
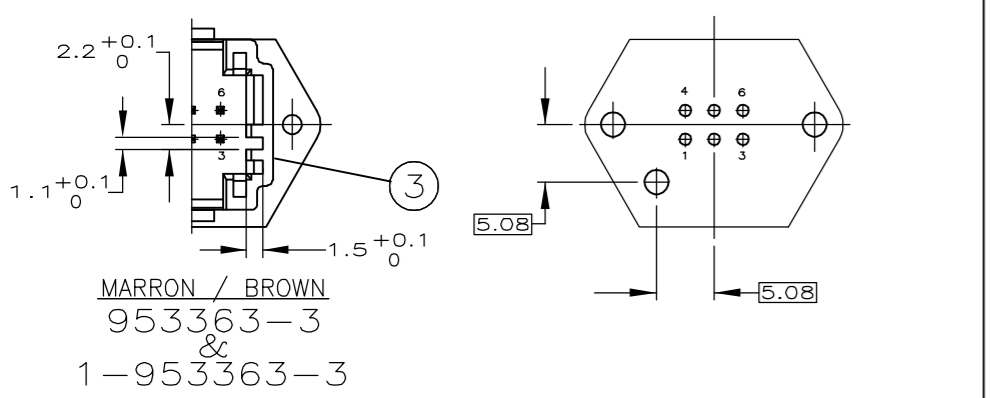
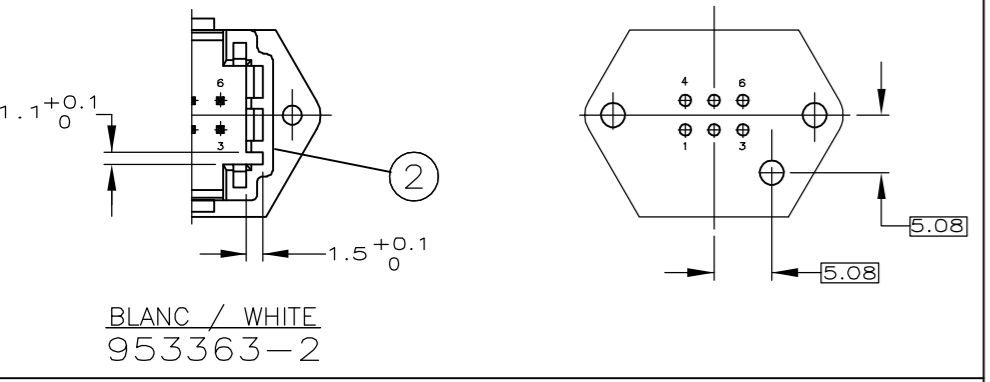
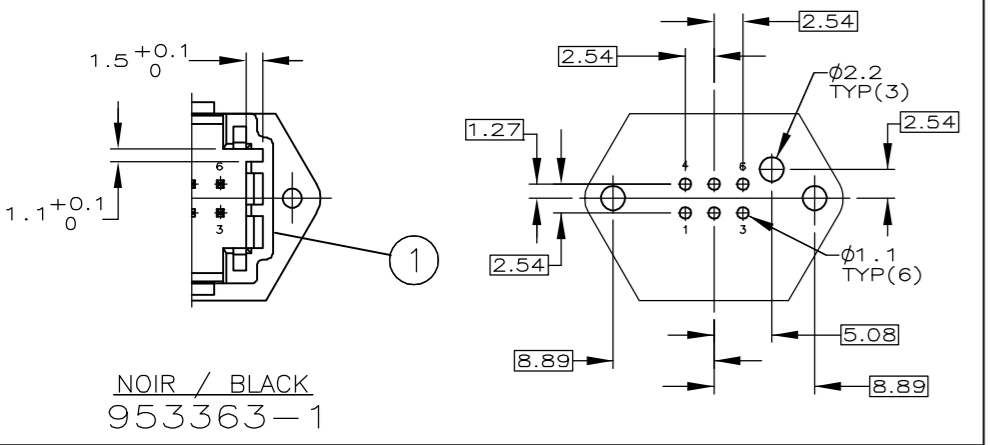

DECOUPE PANNEAU / PANEL CUTOUT

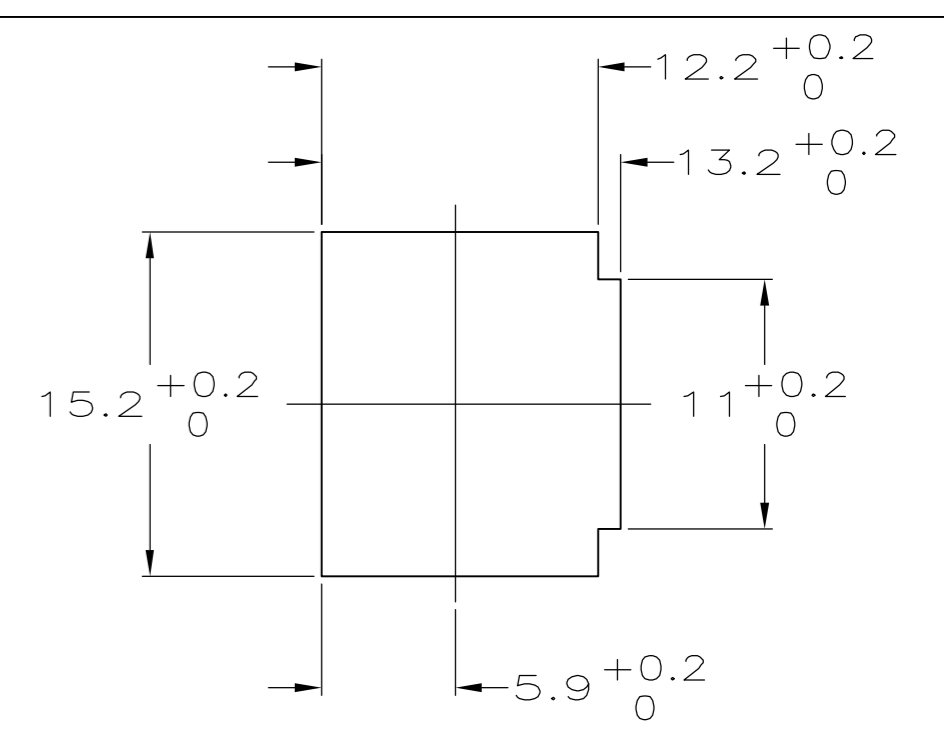

ASSY. PN	REV	MATERIAL	DESIGNATION / NAME	COULEUR / COLOR FINITION	REP.
953363-1	-	CuSn6	MQS CONTACT	DORURE SELECTIVE 0.4µm mini Au sur 1µm mini Ni SELECTIVE GOLD PLATING 0.4µm mini Au over 1µm mini Ni	⑤
953363-2	-	PBT GF20	BOITIER / HOUSING	POST ETAME / POST TIN	④
953363-3	-	PBT GF20	BOITIER / HOUSING	GREEN / VERT	③
953363-4	-	PBT GF20	BOITIER / HOUSING	MARRON / BROWN	②
1-953363-3	-	PBT GF20	BOITIER / HOUSING	WHITE / BLANC	①
1-953363-3	6	PBT GF20	BOITIER / HOUSING	NOIR / BLACK	①
QTY		MATERIAL	DESIGNATION / NAME	COULEUR / COLOR FINITION	REP.

THIS DRAWING IS A CONTROLLED DOCUMENT.  
 CE SCHEMA EST UN DOCUMENT CONTROLÉ

TOLERANCES UNLESS OTHERWISE SPECIFIED:  
 TOLERANCES NON SPECIFIEES (SUIV NB DE DECIMALES):  
 ANGLES 45°

FINISH FINITION

26-JAN-98  
 J. LAQUERBE  
 28-JAN-99  
 J. LAQUERBE  
 28-JAN-99  
 JJ.REVIL  
 PRODUCT SPEC  
 SPEC. PRODUIT

NAME TITRE  
 EMBASE 6V MQS DROITE AVEC OREILLES  
 6W MQS STRAIGHT HEADER WITH EARS

SIZE FORMAT A2  
 CAGE CODE 00779  
 DRAWING NO No PLAN C=953363

RESTRICTED TO

WEIGHT MASSE APPROX. 2 g  
 APPLICATION SPEC. SPEC. APPLICATION

CUSTOMER DRAWING/PLAN CLIENT UNIFORMEMENT POUR REFERENCE SCALE ECHELLE 5:1 SHEET FEUILLE 1 DE 1 REV F

单击下面可查看定价，库存，交付和生命周期等信息

[>>TE Connectivity\(泰科\)](#)