

THIS DRAWING IS UNPUBLISHED.

RELEASED FOR PUBLICATION

20

© COPYRIGHT 20 BY -

ALL RIGHTS RESERVED.

REVISIONS

P	LTR	DESCRIPTION	DATE	DWN	APVD
	A	RELEASED	28MAR2016	K.T	E.T
	AI	REVISED	27APR2016	K.T	E.T
	B	REVISED	02JUN2016	K.T	E.T

REC ASSEMBLY

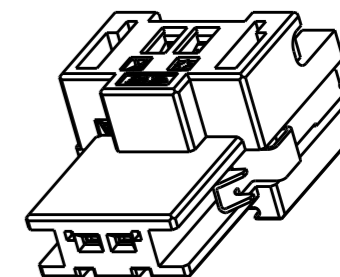
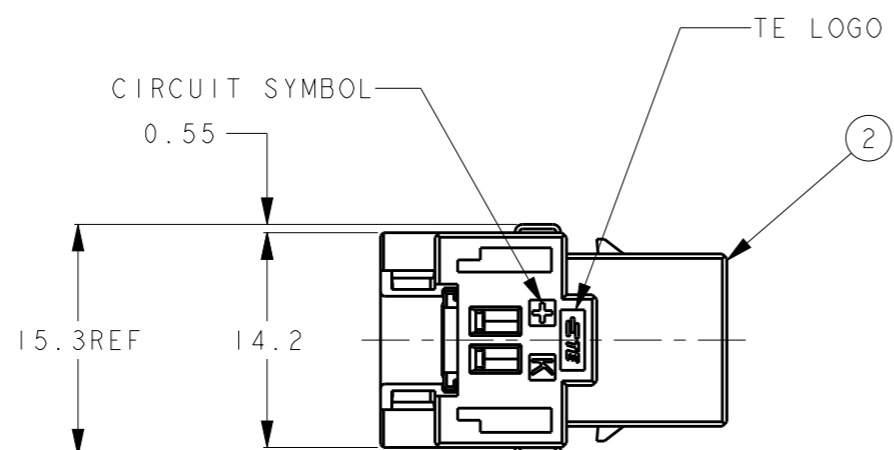

1 MATERIAL:
 CONTACT ASSY: STAINLESS STEEL
 CHROMEL/ALUMEL
 METAL LATCH: STAINLESS STEEL
 HOUSING: THERMOPLASTIC(UL94V-0)
 TRAY: POLYSTYRENE

2 DATE CODE
 YY: YEAR
 WW: WEEK
 D: DAY
 3. REFER TO INSTRUCTION SHEET 408-78115.

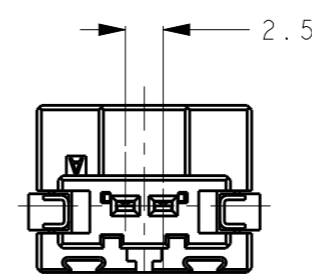
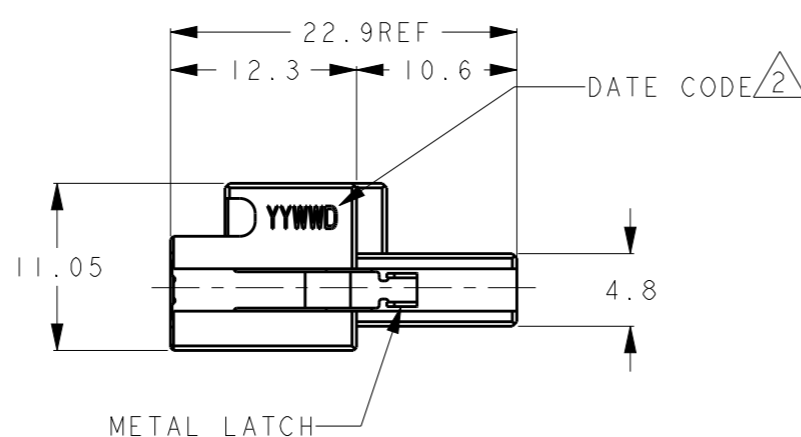
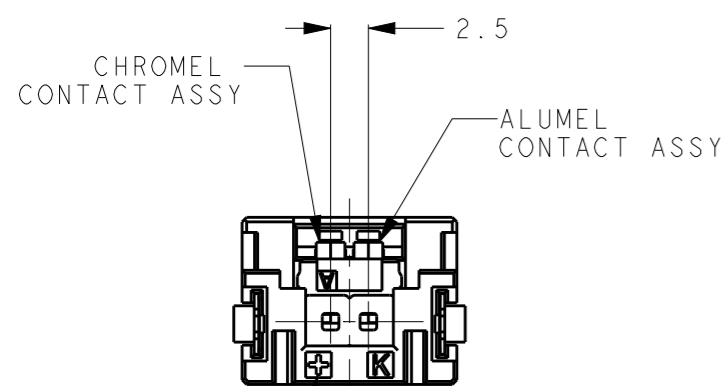

CIRCUIT SYMBOL

1-2299959-1		
90	REC ASSY(SHEET 1)	2
1	TRAY(SEE SHEET 2 OF 2)	1
Q'TY	DESCRIPTION	NO

THIS DRAWING IS A CONTROLLED DOCUMENT.

DIMENSIONS: mm	TOLERANCES UNLESS OTHERWISE SPECIFIED: ± 0.3	DWN K. TERAJIMA 28MAR2016	 TE Connectivity
	0 PLC ± 1 PLC ± 2 PLC ± 3 PLC ± 4 PLC ± ANGLES ±5°	CHK E. TAKEMASA 28MAR2016	
MATERIAL	FINISH	APVD E. TAKEMASA 28MAR2016	
	-	PRODUCT SPEC 108-140100	
		APPLICATION SPEC -	NAME TRAY PACKAGE. THERMOCOUPLE CONNECTOR K-TYPE 2POS REC ASSEMBLY
		WEIGHT -	SIZE A3
		CUSTOMER DRAWING	CAGE CODE -
			DRAWING NO C-2299959
			RESTRICTED TO -
			SCALE 2:1
			SHEET 1 OF 2
			REV B

THIS DRAWING IS UNPUBLISHED. RELEASED FOR PUBLICATION 20



© COPYRIGHT 20 BY - ALL RIGHTS RESERVED.

REVISIONS

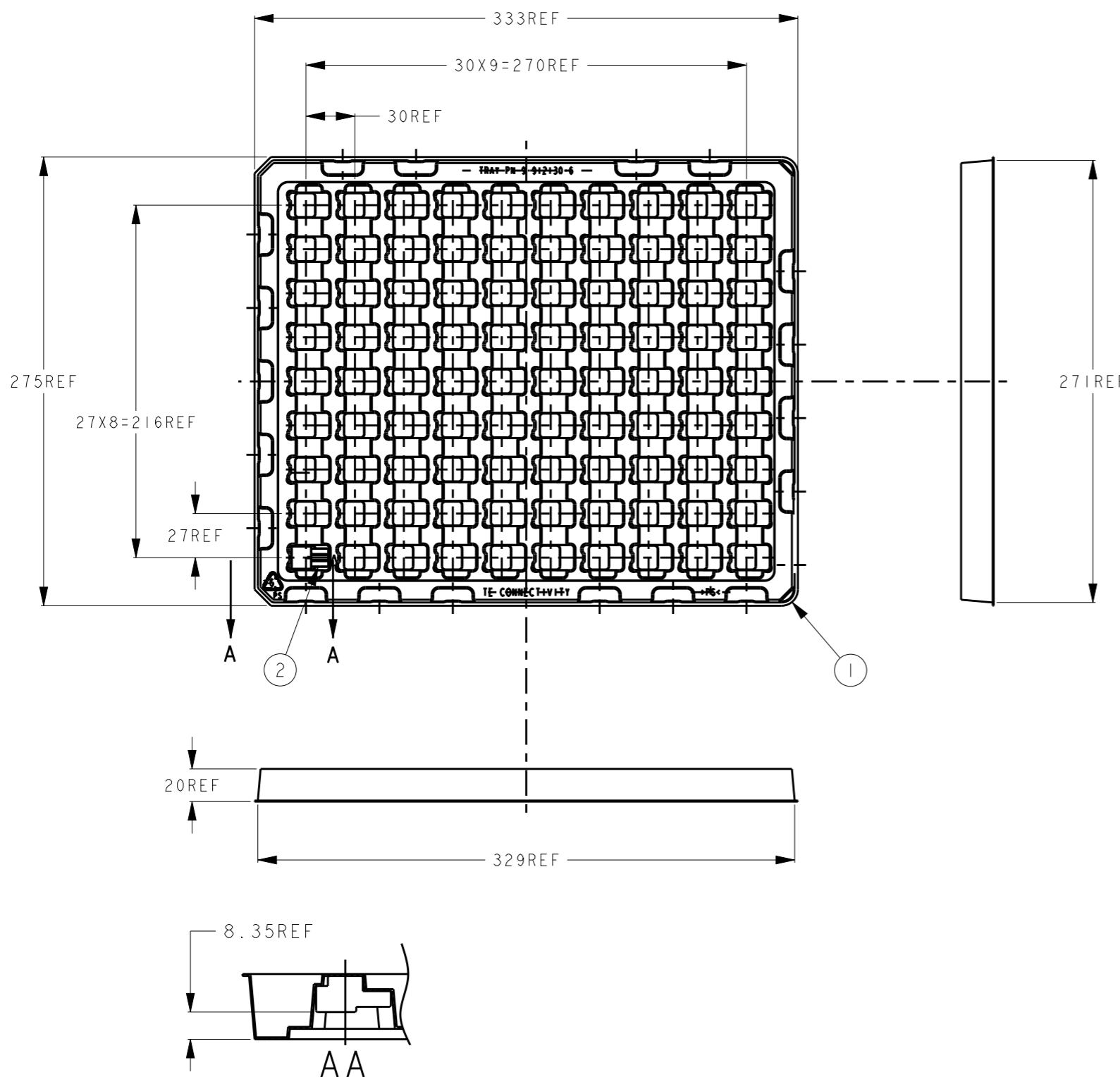
P	LTR	DESCRIPTION	DATE	DWN	APVD
		SEE SHEET 1			



1-2299959-1: AS SHOWN

THIS DRAWING IS A CONTROLLED DOCUMENT.		DWN	 TE Connectivity	
DIMENSIONS: mm		CHK		
TOLERANCES UNLESS OTHERWISE SPECIFIED: ± 0.5		APVD	NAME TRAY PACKAGE, THERMOCOUPLE CONNECTOR K-TYPE 2POS REC ASSEMBLY	
0 PLC ±		PRODUCT SPEC	SIZE	
1 PLC ±		APPLICATION SPEC	CAGE CODE	DRAWING NO
2 PLC ±		WEIGHT	RESTRICTED TO	
3 PLC ±		CUSTOMER DRAWING	A3	-
4 PLC ±		SCALE	C-2299959	
ANGLES ±5°		SCALE	NTS	SHEET 2 OF 2
FINISH		SCALE	NTS	REV B
MATERIAL				

单击下面可查看定价，库存，交付和生命周期等信息

[>>TE Connectivity\(泰科\)](#)