

CONNECTOR ASSEMBLY EXAMPLARY LOADED $\triangle 8$

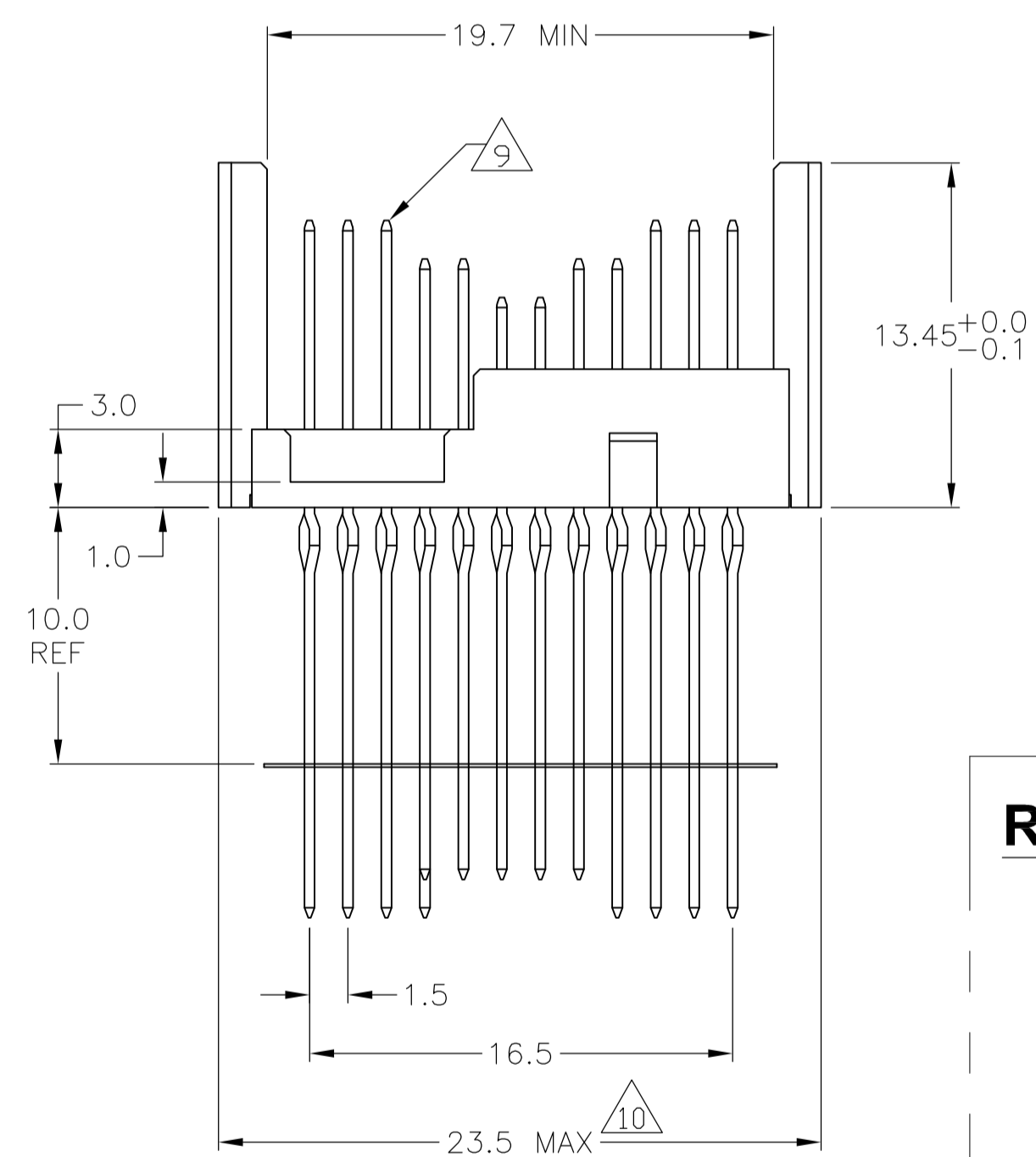

CONTACT DIMENSIONS

SCALE 5:1

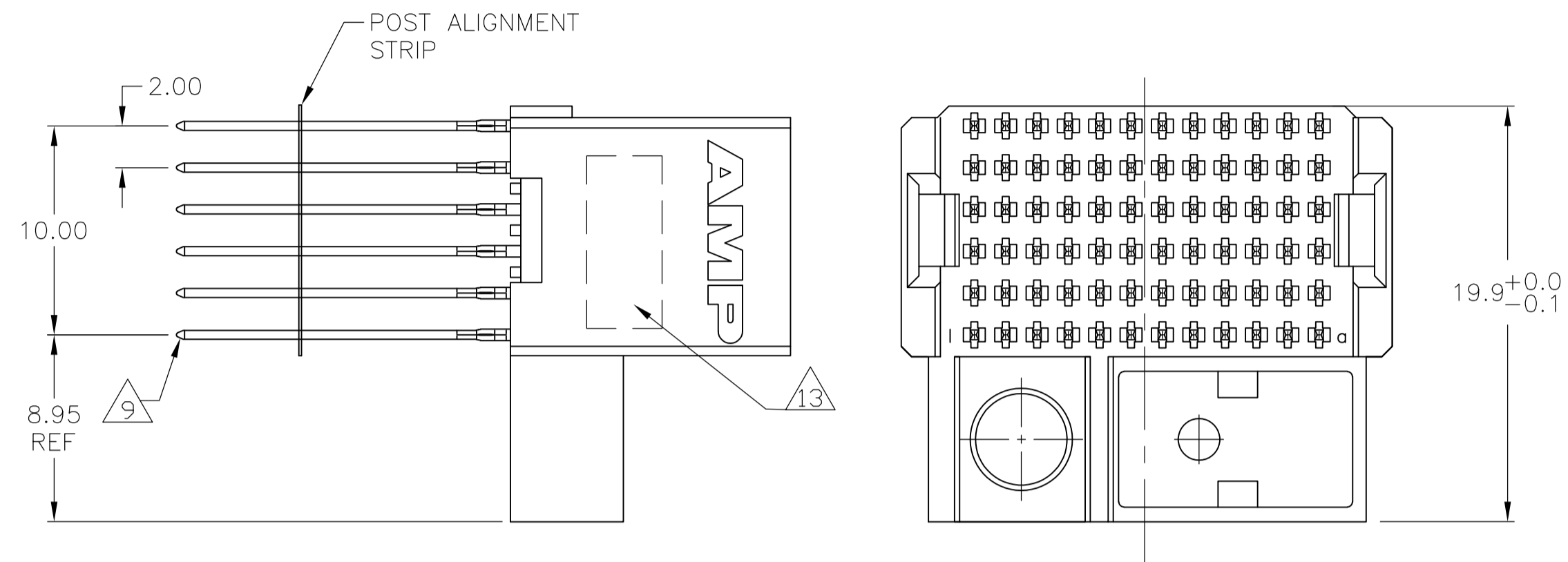
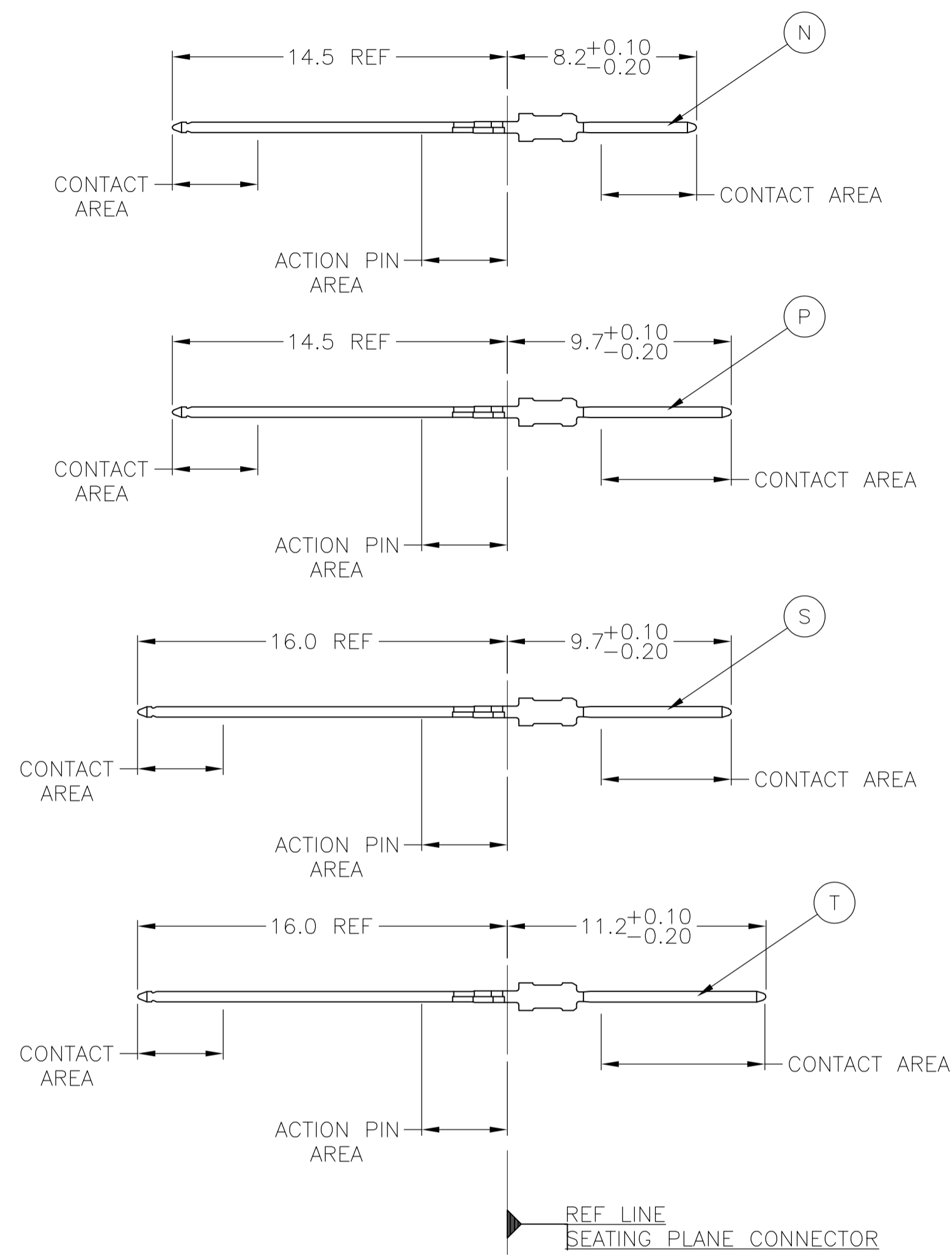

CONTACT LAYOUT

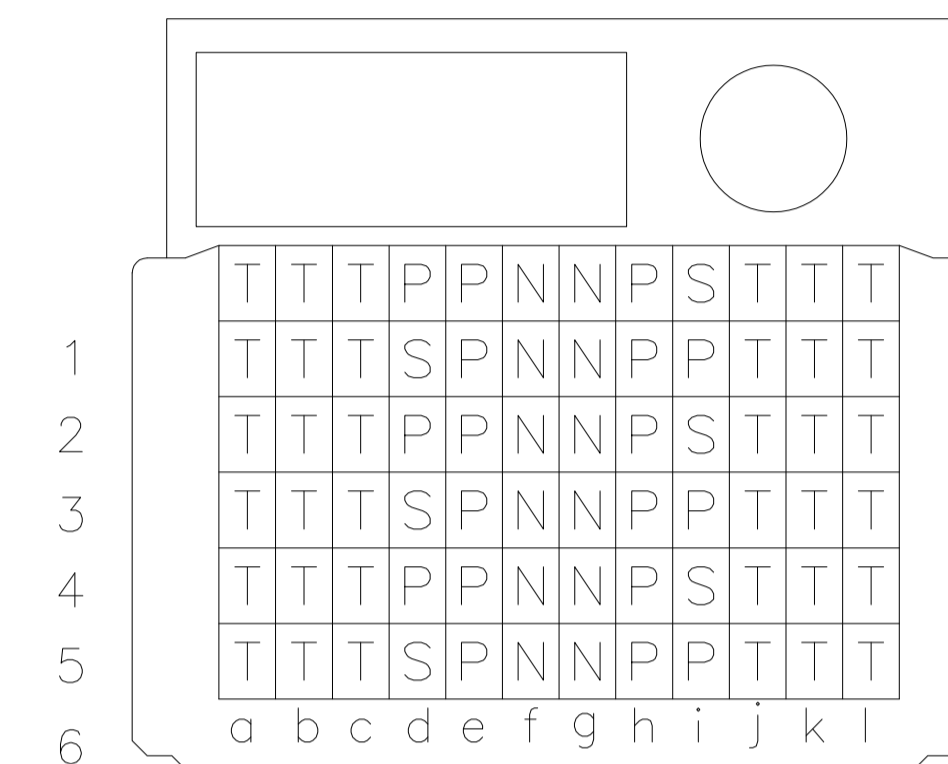

RECOMMENDED PCB-HOLE LAYOUT COMPONENT SIDE SHOWN

PLATED THRU HOLES PARAMETERS

REFERENCE APPLICATION SPECIFICATION

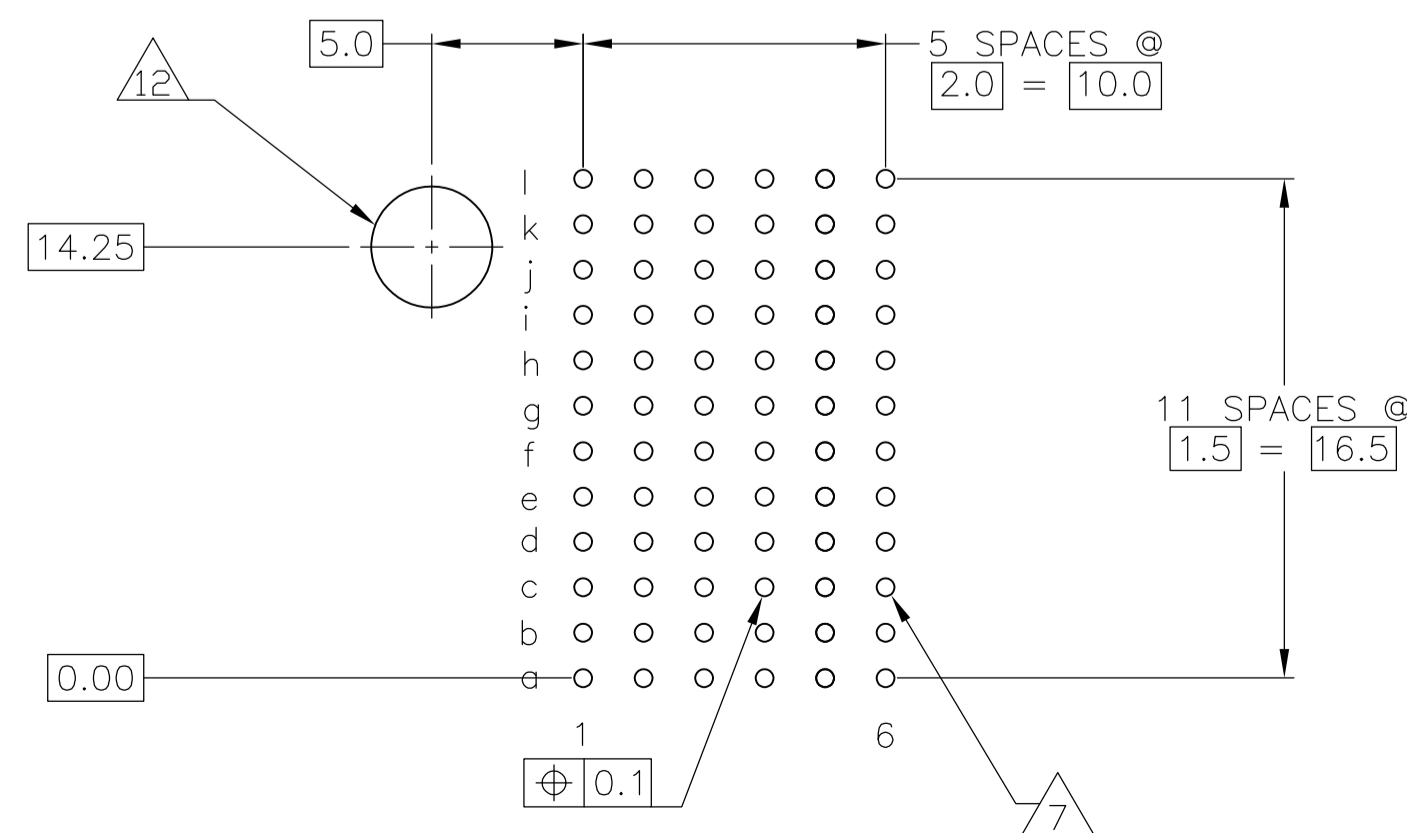

LOC	DIST	REVISIONS			
P	LTR	DESCRIPTION	DATE	DN	APVD
ES	00	A	INITIAL RELEASE	31MAR11	RC CW

THIS DRAWING IS A CONTROLLED DOCUMENT.		DIN	RAYMOND CAO	31MAR11	1645561-1	
DIMENSIONS: mm		CHK	SANDERS YAN	31MAR11	PART NUMBER	
TOLERANCES UNLESS OTHERWISE SPECIFIED:		APVD	MANQIAN WANG	31MAR11	FINISH	
0-PLC ±		NAME		MALE ASSEMBLY, Z-PACK 2mm HM, LEFT HAND, 12 ROW		
1-PLC ±0.1		PRODUCT SPEC		108-1738		
2-PLC ±0.2		APPLICATION SPEC		114-1132		
3-PLC ±		SIZE		A1		
4-PLC ±		CAGE CODE		00779		
ANGLES		DRAWING NO		1645561		
MATERIAL		WEIGHT		CUSTOMER DRAWING		
FINISH		SCALE		4:1		
SEE TABLE		SHEET		1 OF 2		
		REV		A		

THIS DRAWING IS UNPUBLISHED. RELEASED FOR PUBLICATION
COPYRIGHT - By - ALL RIGHTS RESERVED.

LOC		DIST		REVISIONS				
ES	00	REV	LYR	DESCRIPTION	DATE	DMN	APVD	
-	-	-	-	SEE SHEET 1	-	-	-	

- 1 MATERIAL:
CONTACT: PHOSPHOR BRONZE.
HOUSING: GLASS-FILLED POLYESTER.
- 2 GENERAL PLATING SPECIFICATION: UNDERPLATING
(ENTIRE CONTACT): 1.27µm MIN NICKEL AND ACTION
PIN: 0.5µm MIN TIN.
FOR PLATING OF MATING SURFACES SEE APPLICABLE
SPECIFICATION REFERENCE FOR EACH DASH NUMBER.
- 3 CONFORMS TO ALL TESTING ACCORDING TO IEC 61076-4-101
PERFORMANCE LEVEL 2.
- 4 CONFORMS TO ALL TESTING ACCORDING TO IEC 61076-4-101
PERFORMANCE LEVEL 1.
- 5 CONNECTOR TESTED AND QUALIFIED AGAINST TELCORDIA GR-1217-CORE QUALITY LEVEL 3,
CENTRAL OFFICE APPLICATIONS.
- 6 CONNECTOR TESTED AND QUALIFIED AGAINST TELCORDIA GR-1217-CORE QUALITY LEVEL 3,
UNCONTROLLED ENVIROMENT APPLICATIONS.
- 7 PLATED-THROUGH HOLES AT 2x1.5mm SQUARE GRID
PATTERN DEFINED BY CONTACT LAYOUT.
- 8 FOR ACTUAL PIN LOADING SEE "CONTACT LAYOUT".
- 9 FOR ACTUAL PIN DIMENSIONS SEE "CONTACT DIMENSIONS".
- 10 TO BE MEASURED AT BOTTOM OF SHROUD.
- 11 CONNECTOR LUBRICATED WITH BELCORE APPROVED LUBRICANT,
TECHNICAL REFERENCE: TR-NWT-001217 ISSUE 1, SEP 1992.
- 12 GUIDE PIN HOLE DIAMETER CLEARANCE DEFINED BY CHOICE OF GUIDE PIN.
- 13 CONNECTOR PRINTED WITH PART NUMBER AND DATE CODE,
LOCATED APPROXIMATELY AS SHOWN.

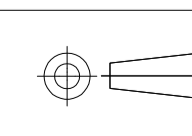
THIS DRAWING IS A CONTROLLED DOCUMENT.		DIN RAYMOND CAO 31MAR11		 TE Connectivity	
DIMENSIONS: mm		CHK SANDERS YAN 31MAR11			
TOLERANCES UNLESS OTHERWISE SPECIFIED:		APVD MANQIAN WANG 31MAR11		NAME MALE ASSEMBLY, Z-PACK 2mm HM, LEFT HAND, 12 ROW	
		PRODUCT SPEC 108-1738		RESTRICTED TO	
MATERIAL SEE SHEET 1		FINISH SEE SHEET 1		APPLICATION SPEC 114-1132	
WEIGHT		SIZE A1		CAGE CODE 00779	
CUSTOMER DRAWING		DRAWING NO. 1645561		SCALE 4:1 SHEET 2 OF 2 REV A	

单击下面可查看定价，库存，交付和生命周期等信息

[>>TE Connectivity\(泰科\)](#)