

4

3

2

1

THIS DRAWING IS UNPUBLISHED. RELEASED FOR PUBLICATION 20
COPYRIGHT 20 BY TYCO ELECTRONICS CORPORATION. ALL INTERNATIONAL RIGHTS RESERVED.

LOC	DIST	REVISIONS					
J	-	P	LTR	DESCRIPTION	DATE	DWN	APVD
		D		REVISED	05DEC2007	T.K	M.K
		E		REVISED	23JUL2010	T.T	T.M
		E I		ADD 6376609-2	18OCT2018	A.W	R.B
		F		ADD NEW PART 6376609-3	22/OCT2019	A.W	R.B

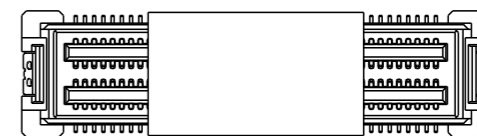
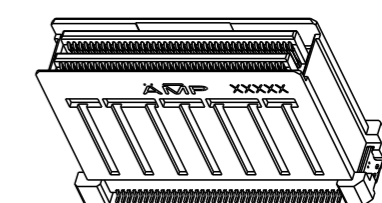
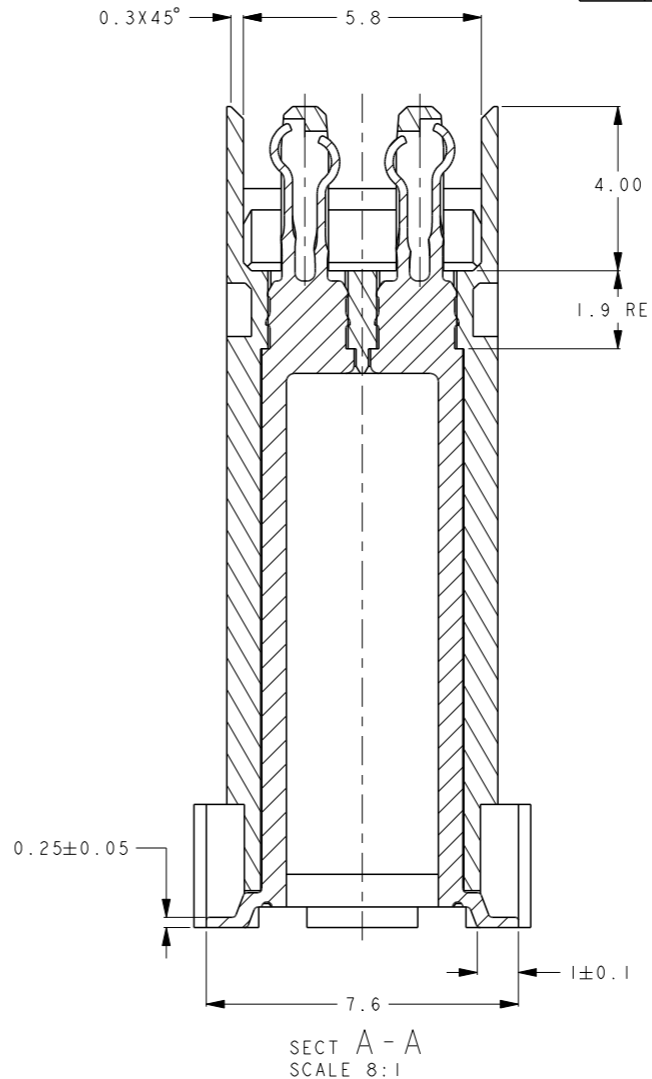
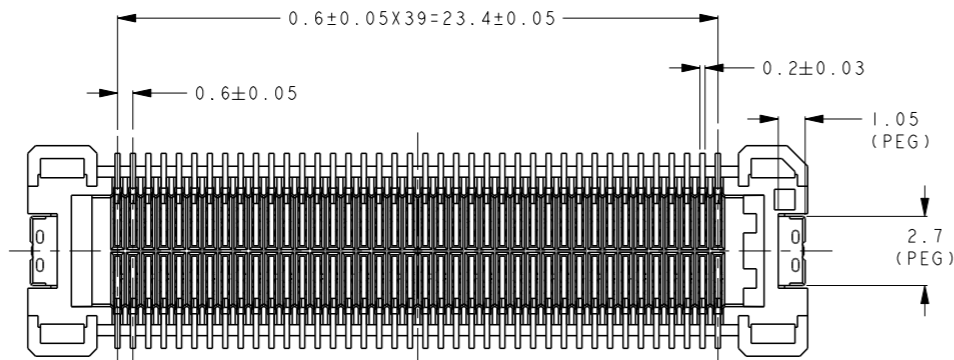
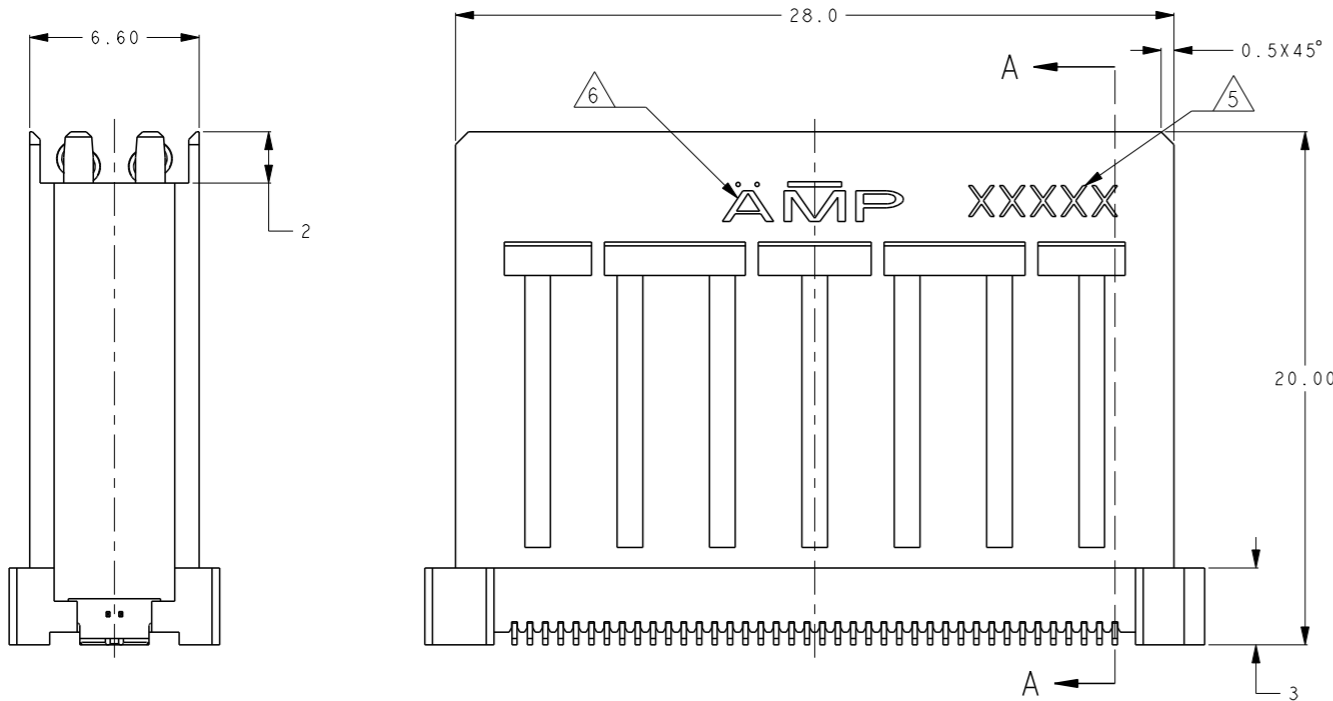
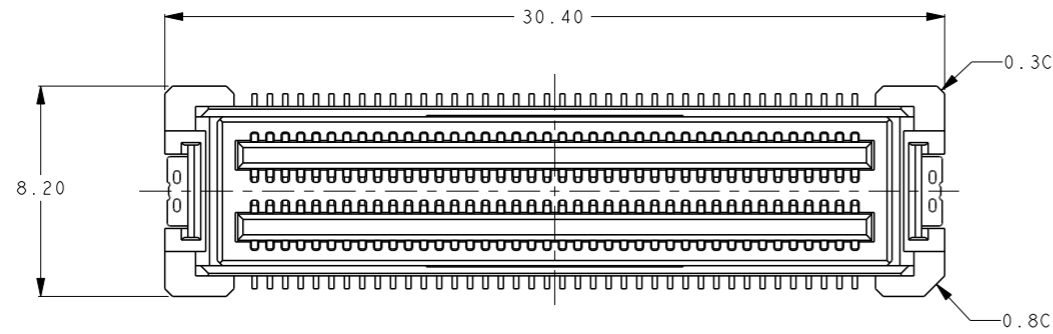

6376609-3

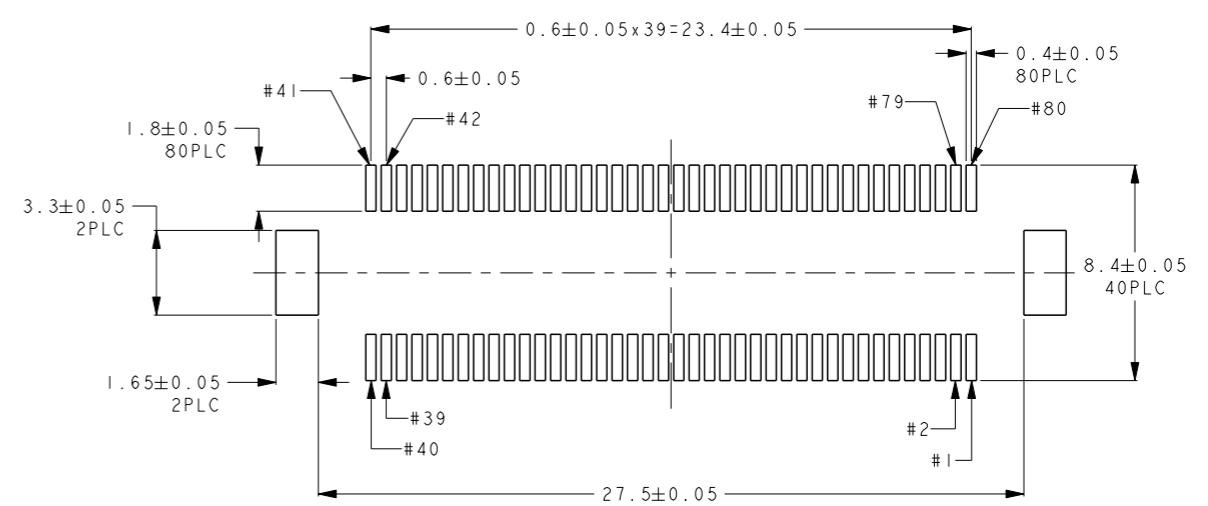

- 1 MATERIAL : HOUSING; LCP
 - 2 FINISH : CONTACT; COPPER ALLOY
UNDER Ni PL. 0.8μmMIN
CONTACT AREA: Au PL. 0.3μmMIN
SOLDERING AREA: Au FLASH
 - 3. COPLANARITY 0.1MAX.
 - 4. -1 IS 45 CONNECTORS IN HARD TRAY,
AND -2 IS 49 CONNECTORS IN HARD TRAY (SEE SHEET 2,3)
 - 5 DATE CODE IS MARKED TO CHINA PRODUCTION PRODUCT.
THE FACE SIDE AND BACK SIDE IS NOT ASKED.
 - 6 AMP : MADE IN JAPAN
 - 7 AMP : MADE IN CHINA
- CONNECTORS AND TRAY SHALL BE COVERED BY PLASTIC BAG WITH ENCLOSED DESICCANT.

PACKAGE	PART NO
HARD TRAY WITH MYLAR	6376609-3
HARD TRAY	6376609-2
HARD TRAY	6376609-1

RECOMMENDED PCB LAYOUT

THIS DRAWING IS A CONTROLLED DOCUMENT FOR TYCO ELECTRONICS CORPORATION IT IS SUBJECT TO CHANGE AND THE CONTROLLING ENGINEERING ORGANIZATION SHOULD BE CONTACTED FOR THE LATEST REVISION.		DWN K. Sakai 23JAN2006 CHK E. Takemasa 23JAN2006 APVD M. Kimura 23JAN2006	Tyco Electronics Corporation Kawasaki, Japan
DIMENSIONS: mm	TOLERANCES UNLESS OTHERWISE SPECIFIED: 0 PLC ±0.3 1 PLC ±0.25 2 PLC ±0.2 3 PLC ± 4 PLC ± ANGLES ±3°	NAME 108-5724 APPLICATION SPEC	HDR ASSEMBLY 20mm HEIGHT 0.6mm PITCH 80P MICRO-STACK CONNECTOR
MATERIAL SEE NOTE	WEIGHT 3.9g	SIZE CAGE CODE DRAWING NO A200779 C-6376609	RESTRICTED TO
CUSTOMER DRAWING		SCALE 5:1	SHEET 1 OF 2 REV F

THIS DRAWING IS UNPUBLISHED. RELEASED FOR PUBLICATION 20
 © COPYRIGHT 20 BY TYCO ELECTRONICS CORPORATION. ALL INTERNATIONAL RIGHTS RESERVED.

LOC	DIST	REVISIONS					
J	-	P	LTR	DESCRIPTION	DATE	DWN	APVD
		-		SEE SHEET 1			

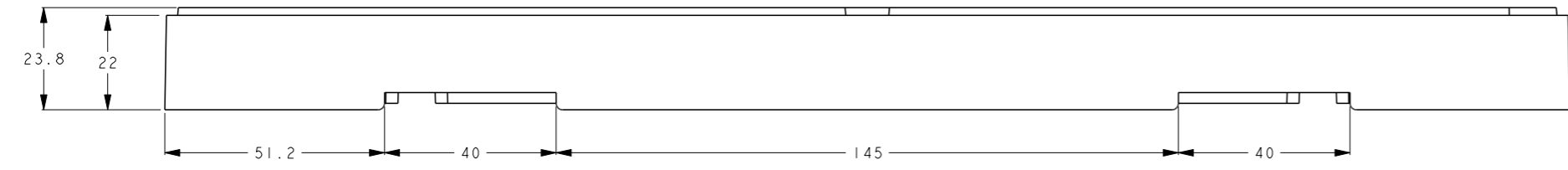
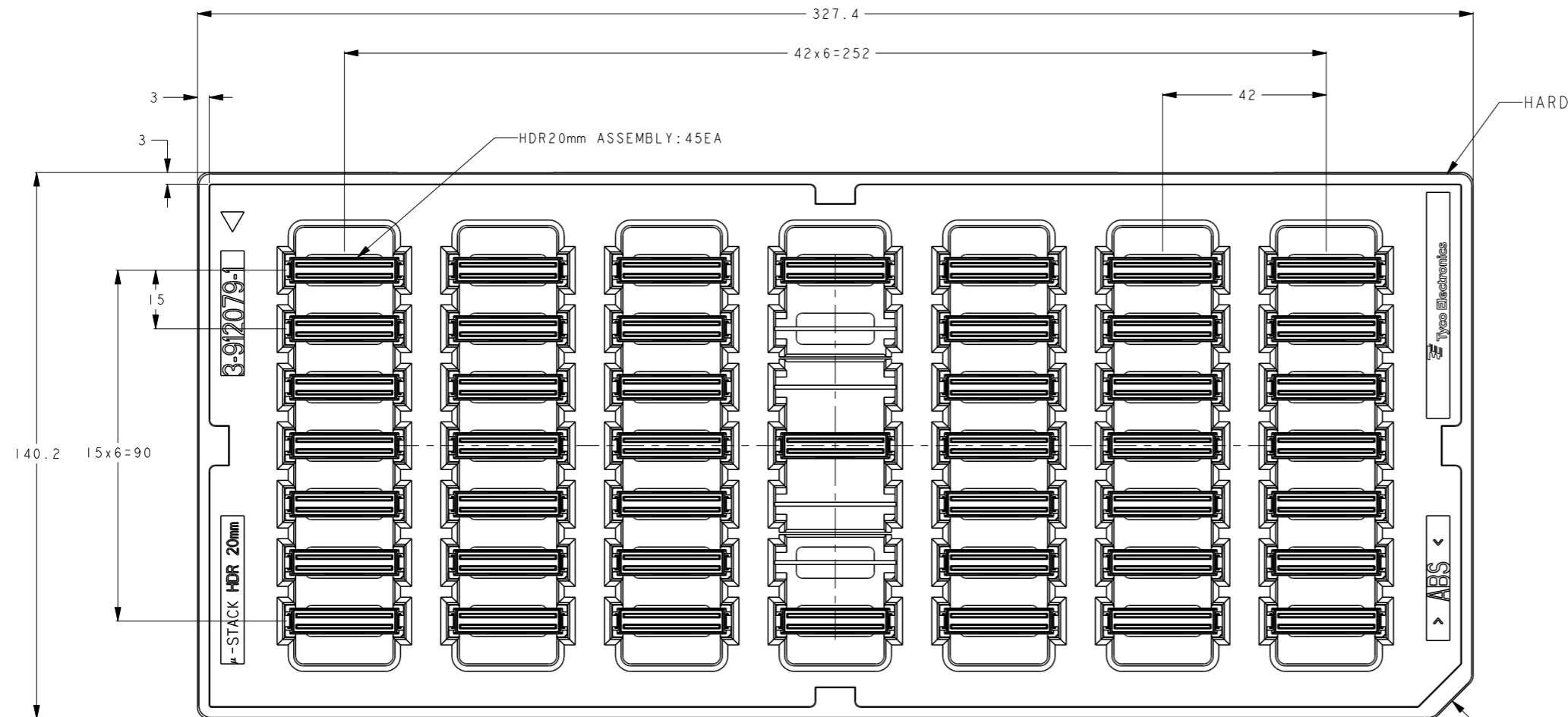

HARD TRAY PACKING SPEC

45	BLACK
CONN QTY	HARD TRAY COLOR

<small>THIS DRAWING IS A CONTROLLED DOCUMENT FOR TYCO ELECTRONICS CORPORATION IT IS SUBJECT TO CHANGE AND THE CONTROLLING ENGINEERING ORGANIZATION SHOULD BE CONTACTED FOR THE LATEST REVISION.</small>		DWN 23JAN2006 K. Sakai CHK 23JAN2006 E. Takemasa APVD 23JAN2006 M. Kimura	Tyco Electronics Corporation Kawasaki, Japan
DIMENSIONS: mm	TOLERANCES UNLESS OTHERWISE SPECIFIED: ± 1 0-PLC ±0.3 1-PLC ±0.25 2-PLC ±0.2 3-PLC ± 4-PLC ±	NAME HDR ASSEMBLY 20mm HEIGHT 0.6mm PITCH 80P MICRO-STACK CONNECTOR	RESTRICTED TO
MATERIAL 	ANGLES ±3° FINISH	APPLICATION SPEC 108-5724 WEIGHT 3.9g	SIZE CAGE CODE DRAWING NO A200779C-6376609
CUSTOMER DRAWING		SCALE 1:1	SHEET 2 OF 2 REV F

单击下面可查看定价，库存，交付和生命周期等信息

[>>TE Connectivity\(泰科\)](#)