

REVISIONS

P	LTR	DESCRIPTION	DATE	DWN	APVD
A		INITIAL RELEASE	28DEC2015	DL	CW
B		ECR-18-017119	23NOV2018	BS	CW
C		ECR-21-111798	06OCT2021	WQR	CW

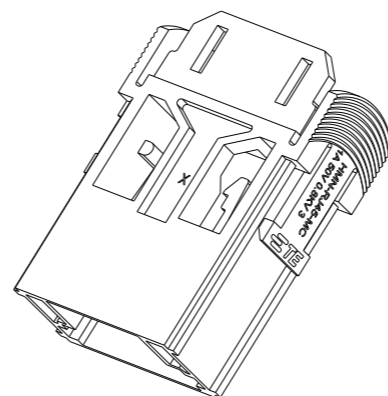
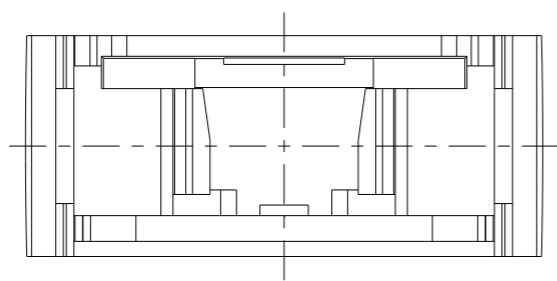

SCALE 1:1

NOTES:

- TECHNICAL CHARACTERISTICS:
 INSULATION MATERIAL: PC
 RATED VOLTAGE: 50V
 RATED CURRENT: 1A
 INSULATION RESISTANCE: $\geq 400M\Omega$
 RATED IMPULSE VOLTAGE: 0.8KV
 POLLUTION DEGREE: 3
 FLAMMABILITY: UL94V-0
 MATING CYCLES: 500

注释:

- 技术参数:
 绝缘材料: PC
 额定电压: 50V
 额定电流: 1A
 绝缘电阻: $\geq 400M\Omega$
 脉冲电压: 0.8KV
 污染等级: 3
 阻燃等级: UL94V-0
 插拔次数: 500

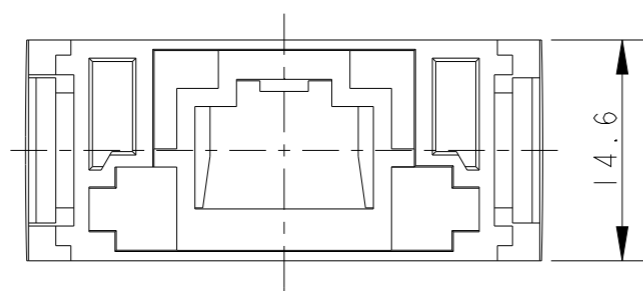
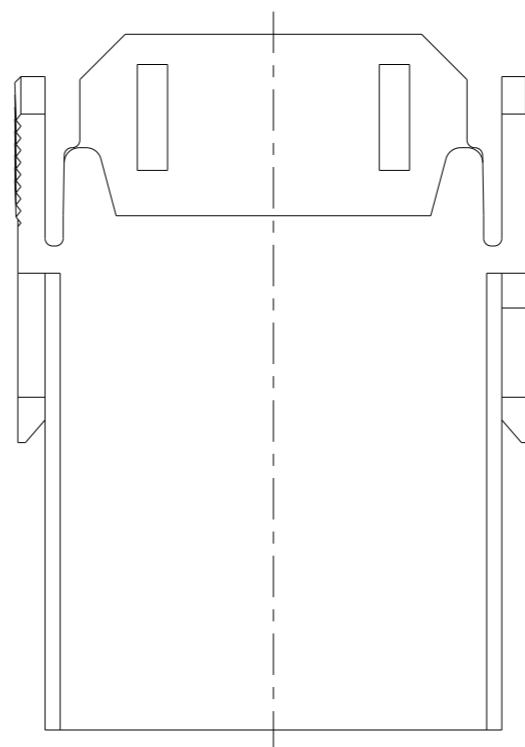
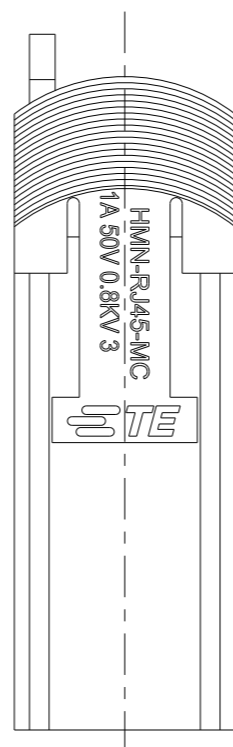
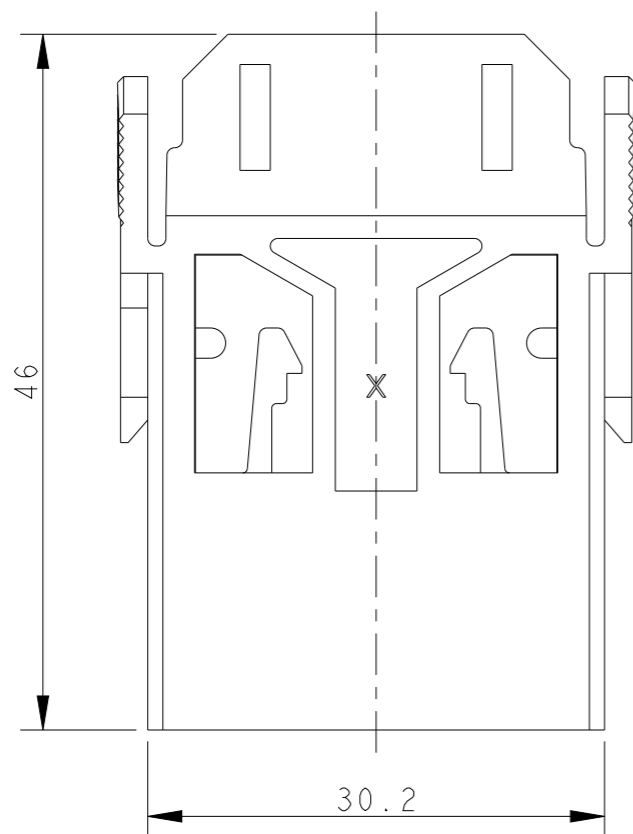
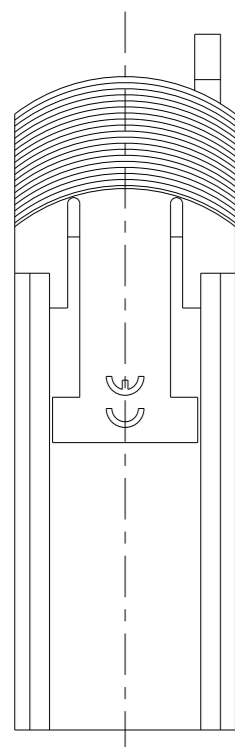

T2113000101-100	HMN-RJ45-MC	HMN-RJ45 MALE MODULE INSERT HMN-RJ45 公插, 压接头
PART NUMBER 料号	PART DESCRIPTION 描述	
STE TE Connectivity		
DWN 28DEC2015 DAVID LI		NAME HMN-RJ45-MC
CHK 28DEC2015 CHRIS WANG		
APVD 28DEC2015 XU XIANG		
PRODUCT SPEC 108-137065		
APPLICATION SPEC 114-137065		SIZE A3
WEIGHT -		CAGE CODE -
CUSTOMER DRAWING		DRAWING NO T2113000101100
SCALE 2:1		RESTRICTED TO -
SHEET 1 OF 1		REV C

THIS DRAWING IS A CONTROLLED DOCUMENT.

DIMENSIONS:	TOLERANCES UNLESS OTHERWISE SPECIFIED:
mm	
	0 PLC \pm
	1 PLC \pm
	2 PLC \pm
	3 PLC \pm
	4 PLC \pm
	ANGLES \pm
MATERIAL	FINISH
-	-
-	-

单击下面可查看定价，库存，交付和生命周期等信息

[>>TE Connectivity\(泰科\)](#)