



SMB Connectors

Product Facts

- **SMB offers snap-fit coupling for quick connect/disconnect**
- **Choice of Commercial or High Rel Connectors**
- **50 and 75 Ω MIL-Type connectors available**
- **Straight plugs and jacks are completely crimp terminated**
- **Fast easy cable assembly**
- **Low VSWR**
- **Standard military, commercial or Tyco Electronics tooling**
- **Listed under the Component Program of Underwriters Laboratories Inc., File No. E81956** 
- **PC Board soldered connectors are recognized under the Component Program of Underwriters Laboratories Inc., File No. E81956** 
- **Certified by Canadian Standards Association File No. LR 7189** 

SMB Connectors are available in commercial and high rel versions. They are ideally suited for circuit miniaturization and are offered in a wide range of configurations including plugs, right-angle plugs, jacks, bulkhead jacks and adapters, as well as printed circuit board and solder jacks.

Termination costs are kept to a minimum using plugs and jacks with a crimp center contact and hex crimp outer braid. Both hand held tooling and pneumatic bench-mounted tooling is available. Easily assembled right-angle plugs have a hex crimp on the outer braid ferrule and bifurcated solder center contacts.

Tyco Electronics' 75 Ohm BT 43 SMB Connectors feature unique spring mating with snap-fit couplings for quick connect/disconnect. These connectors are designed to be intermateable with 75 Ohm SMB MIL-C-39012 connectors. They also feature reliable dual crimp cable terminations.



Packaging — All connectors are packaged individually unless otherwise noted under the "Military No. and/or Comments" column in the connector specifications chart.

Between Series Adapters

For SMB Between Series Adapters, please see pages 251-260.

SMB Connector Specifications

Electrical Characteristics

Impedance — 50 ohms and 75 ohms, nominal

Frequency Range — 0 to 4.0 GHz

Voltage Rating (VRMS) —

	Sea Level	70,000 Feet
50 ohm connectors for RG 178/U series cable	300	75
50 ohm connectors for RG 316/U series cable	400	100
75 ohm connectors for RG 179/U series cable	300	75
75 ohm connectors for RG 195/U series cable	500	125

Insulations Resistance — 1000 megohms min.

Contact Resistance — (milliohms max.)

	Initial	After Environment
Center contact	6.0	8.0
Outer contact	1.0	1.5
Braid to body	1.0	N/A

Contact Current Rating — 1.5 amps DC max.

Voltage Standing Wave Ratio (VSWR) —

to 4.0 GHz or 80% of upper cutoff frequency of the cable, whichever is lower.

Cable	Mating Engagement	
	Straight	Right-Angle
RG 178/U Series	1.30 + .04F	1.45 + .06F
RG 316/U Series	1.25 + .04F	1.35 + .04F

F=GHz, does not apply to 75 ohm connectors.

RF High Potential Withstanding Voltage

Frequency — 5 MHz

Leakage Current — N/A

50 ohm connectors for RG 178/U series cable	675 VRMS
50 ohm connectors for RG 316/U series cable	950 VRMS
75 ohm connectors for RG 179/U series cable	950 VRMS
75 ohm connectors for RG 195/U series cable	1225 VRMS

RF Leakage — -55 dB min. at 2-3 GHz

Insertion Loss — .30dB max. at 3 GHz

Mechanical Characteristics

Engagement Forces — 14 lbs. [62.3 N] maximum engagement initially.

After 500 matings, 14 lbs. [62.3 N] maximum engagement and 2 lbs. [8.8 N] minimum disengagement for all of SMBs.

Cable Attachment —

Straight Connectors — Crimp, both center contact and braid

Right-Angle Connectors — Crimp on braid and bifurcated solder center contact

Durability — 500 cycles per MIL-C-39012

Contact Captivation — When captivated, the contacts will withstand 4.0 lbs. minimum axial force.

Cable Retention — When properly assembled to the compatible braided coaxial cable, the retention is equal to the breaking strength of the cable.

Marking — Per MIL-STD-130

Environmental Characteristics

Temperature Rating — -65°C to +165°C

Corrosion (salt spray) — MIL-STD-202, Method 101, test condition B, 5% salt solution

Vibration High Frequency — MIL-STD-202, Method 204, test condition B (15 G's)

Shock — MIL-STD-202, Method 213, test condition B, 75 G's at 6 milliseconds, 1/2 sine

Thermal Shock — MIL-STD-202, Method 107, test condition B, except high temperature shall be +85°C. High temperature shall be +200°C for connectors using 200°C cables.

Moisture Resistance — MIL-STD-202, Method 106, when interface gasket is used. No measurements of high humidity. Insulation resistance shall be 200 megohms minimum within five minutes after removal from humidity.

Durability Test — Conducted per MIL-C-39012 Reg. Para. 3.15, Method Para. 4.6.12

Materials

Body, Body Components and Male Contacts — Brass, half hard, per QQ-B-626, Alloy 360, Zinc per QQ-Z-363

Female Contacts — Beryllium copper per QQ-C-530, heat treated per MIL-H-7199

Insulators — TFE fluorocarbon per ASTM D 1710, Type 1, Grade 1

Lockwashers — Phosphor bronze per QQ-B-750

Crimp Ferrule — Annealed copper alloy per WW-T-799

Gaskets — Silicone rubber per ZZ-R-765, Class 11B, Grade 65-75

Plating

Center Contacts — 0.00127 [0.00050] min. Gold per MIL-G-452048 Type 1, Grade C, Class 1, over 0.00254 [0.00100] min. nickel per QQ-N-290

Other Metal Parts — Gold, Nickel or Solder plated to meet the Finish and Corrosion requirements of MIL-C-39012

SMB Connectors, 50 Ohm

Straight Plugs

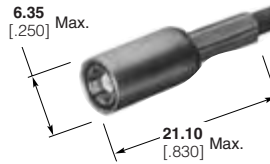

RG/U Cable	Center Contact Plating	Outer Contact Plating	Other Metal Parts Plating	Dielectric	Style	Part No.
178, 178A, 178B, 196, 196A	Gold	Gold	Nickel	PTFE	MIL Type	413985-6
174, 316, 188, 188A	Gold	Gold	Gold	PTFE	MIL Type	413985-1
	Gold	Gold	Nickel	PTFE	MIL Type	413985-3
	Gold	Nickel	Nickel	PTFE	MIL Type	413985-7
	Gold	Gold	Nickel	PTFE	Die Cast	414946-1
179, 179A, 179B, 161, 187, 187A, BELDEN 9221	Gold	Nickel	Nickel	PTFE	Die Cast	5414946-2
	Gold	Gold	Nickel	PTFE	MIL Type	1-413985-1
	Gold	Gold	Nickel	PTFE	Die Cast	5414946-5
RG 316, 188 Double Braid	Gold	Nickel	Nickel	PTFE	Die Cast	5414946-6
	Gold	Gold	Gold	PTFE	MIL Type	413985-2
	Gold	Gold	Nickel	PTFE	MIL Type	413985-4
	Gold	Gold	Nickel	PTFE	Die Cast	5414946-3
	Gold	Nickel	Nickel	PTFE	MIL Type	413985-8

Right-Angle Plugs

MIL Type

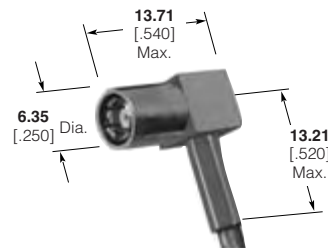

Die Cast

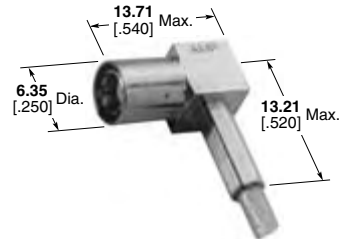

RG/U Cable	Center Contact Plating	Outer Contact Plating	Other Metal Parts Plating	Dielectric	Style	Part No.
178, 178A, 178B, 196, 196A	Gold	Gold	Gold	PTFE	MIL Type	414002-7
	Gold	Gold	Nickel	PTFE	MIL Type	414002-8
	Gold	Gold	Nickel	PTFE	Die Cast	5414363-8
174, 316, 188, 188A, 179, 179A, 179B, 161, 187, 187A, BELDEN 9221	Gold	Gold	Gold	PTFE	MIL Type	414002-1
	Gold	Gold	Nickel	PTFE	MIL Type	414002-3
	Gold	Nickel	Nickel	PTFE	MIL Type	414002-5
	Gold	Gold	Nickel	PTFE	Die Cast	5414363-3
RG 316, 188 Double Braid	Gold	Nickel	Nickel	PTFE	Die Cast	5414363-5
	Gold	Gold	Gold	PTFE	MIL Type	414002-2
	Gold	Gold	Nickel	PTFE	MIL Type	414002-4
	Gold	Gold	Nickel	PTFE	Die Cast	5414363-4

BELDEN is a trademark of Belden Wire and Cable Company.

Note: Part Numbers are RoHS compliant except: ♦ Indicates non-RoHS compliant.

SMB Connectors, 50 Ohm (Continued)

Straight Jacks

Commercial Jack

MIL Type Jack

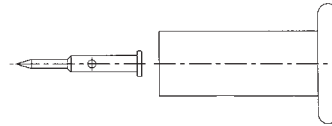
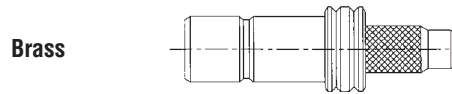
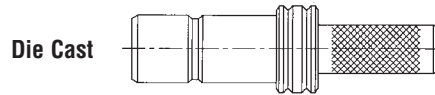
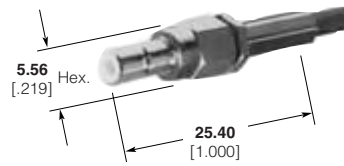

RG/U Cable	Center Contact Plating	Body Plating	Dielectric	Style	Jack Part No.
178, 178A, 178B, 196, 196A	Gold	Nickel	PTFE	MIL Type	5414170-2
174, 316, 188, 188A	Gold	Nickel	PTFE	MIL Type	5414170-1
	Gold	Nickel	PTFE	Die Cast	414948-1
RD 316, 188 Double Braid	Gold	Nickel	PTFE	Commercial	414948-3

Bulkhead Jacks

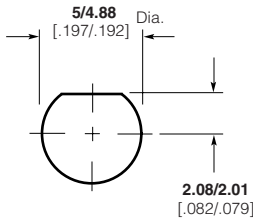

Maximum Panel Thickness **2.36** [.093]
Recommended Panel Cutout for Bulkhead Jack and Adapter

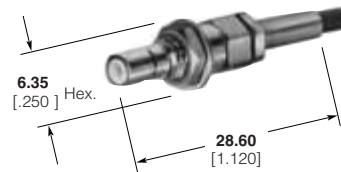

RG/U Cable	Center Contact Plating	Body Plating	Dielectric	Style	Bulkhead Jack Part No.
174, 316, 188, 188A	Gold	Nickel	PTFE	Commercial	5415006-1
	Gold	Nickel	PTFE	Commercial	5228217-1
RD 316, 188 Double Braid	Gold	Nickel	PTFE	Commercial	5415006-2

Bulkhead Jack Adapter (Jack-Jack)

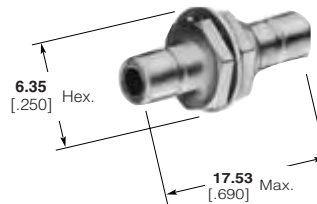

Type	Center Contact Plating	Body Plating	Dielectric	Style	Part No.
Jack-To-Jack	Gold	Nickel	PTFE	MIL Type	228553-1
	Gold	Gold	PTFE	MIL Type	228553-2

Note: Part Numbers are RoHS compliant except: ♦ Indicates non-RoHS compliant.

SMB Connectors, 50 Ohm (Continued)

**PC Board
Vertical Jacks**

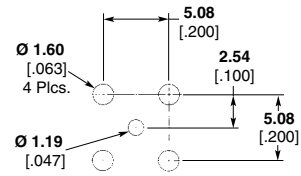
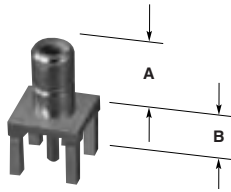

**Recommended
PC Board Layout**

Jacks

Type	Center Contact Plating	Body Plating	Dim. A	Dim. B	Dielectric	Style	Part No.
—	Gold	Gold	7.62 .300	3.94 .155	PTFE	MIL Type	413990-1
—	Gold	Nickel	7.62 .300	3.94 .155	PTFE	MIL Type	413990-2
—	Gold	Nickel	10.16 .400	2.54 .100	PTFE	MIL Type	414612-2
—	Gold	Tin	3.94 .155	8.25 .325 Max.	PTFE	Brass, Stamped	5221111-1

**PC Board
Vertical Plugs**

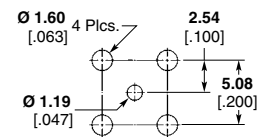
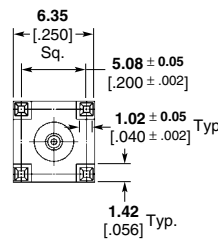
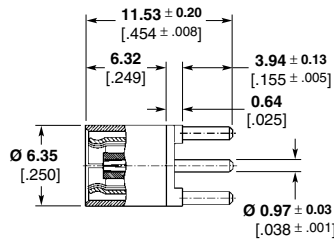
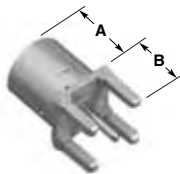

**Recommended
PC Board Layout**

Plugs

Type	Center Contact Plating	Body Plating	Dim. A	Dim. B	Dielectric	Recommended PC Board Layout	Style	Part No.
Low Profile (Plug) Mated Pair	Gold	Nickel	3.94 .155	7.62 300	PTFE	B	MIL Type	415774-1

Note: Part Numbers are RoHS compliant except: ♦ Indicates non-RoHS compliant.

SMB Connectors, 50 Ohm (Continued)

**PC Board,
Right-Angle Jacks**

Jack Low Profile

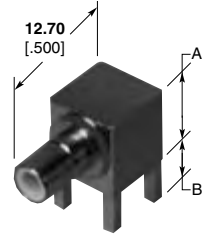

Jack with Standoff Pads

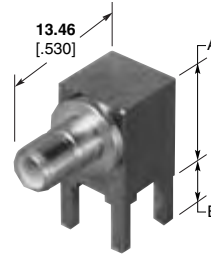

Bulkhead Jack

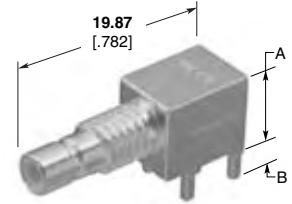

Jacks

Type	Center Contact Plating	Interface Body Plating	PCB Leg Plating	Dielectric	Dim. A	Dim. B	Style	Recommended PC Board Layout	Part No.
Low Profile	Gold	Gold	Gold	PTFE	7.11 .280	3.94 .155	MIL Type	A	413996-2
	Gold	Nickel	Nickel	PTFE	7.11 .280	3.94 .155	MIL Type	A	413996-4
	Gold	Gold	Gold	PTFE	7.11 .280	2.79 .110	Die Cast	A	415340-1
	Gold	Gold	Gold	PTFE	8.76 .345	2.79 .110	Die Cast	A	415672-1
With Standoff Pads	Gold	Gold	Gold	PTFE	8.51 .335	3.94 .155	MIL Type	A	414026-2
	Gold	Nickel	Nickel	PTFE	8.76 .345	3.94 .155	MIL Type	A	414026-3
	Gold	Nickel	Tin-Lead	PTFE	8.76 .345	3.94 .155	Die Cast	A	5414337-1
	Gold	Nickel	Nickel	PTFE	8.76 .345	2.79 .110	Die Cast	B	5415379-1*
Bulkhead	Gold	Gold	Gold	PTFE	8.51 .335	3.94 .155	Die Cast	A	415381-1♦
	Gold	Nickel	Nickel	PTFE	8.76 .345	3.94 .155	MIL Type	A	414026-3
Bulkhead	Gold	Gold	Gold	PTFE	7.67 .302	2.79 .110	Die Cast	A	414963-1
Commercial	Gold	Nickel	Tin	Polypropylene	9.78 .385	3.94 .155	Brass, Stamped	C	5228435-1
Bulkhead	Gold	Gold	Gold	PTFE	7.67 .302	2.79 .110	Die Cast	A	1274330-1

* 5 leg design

**PC Board,
Right-Angle Plug**

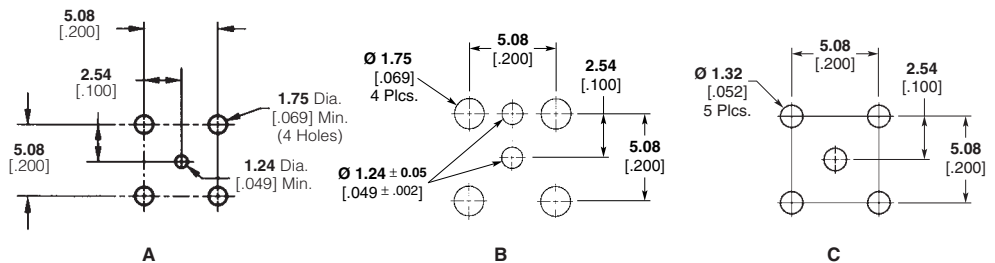
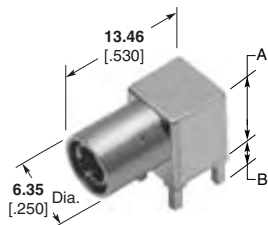

**Recommended
PC Board Layouts**

Plugs

Center Contact Plating	Interface Body Plating	PCB Leg Plating	Dielectric	Dim. A	Dim. B	Style	Recommended PC Board Layout	Part No.
Gold	Nickel	Nickel	PTFE	8.76 .345	2.79 .110	Die Cast	B	415380-1*
Gold	Nickel	Tin	PTFE	8.76 .345	3.94 .155	Die Cast	A	5414338-1

* 5 leg design

Note: Part Numbers are RoHS compliant except: ♦ Indicates non-RoHS compliant.

SMB Connectors, 50 Ohm (Continued)

**Bulkhead PC Board Jack,
Solder Receptacle Kits**

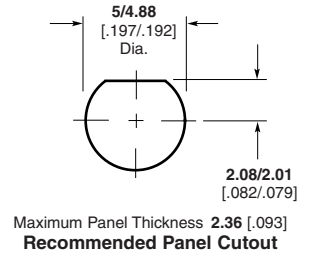
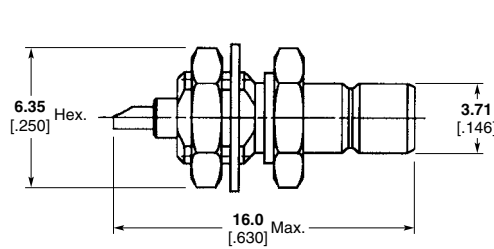

**Kit Includes Lockwasher
and Jam Nut**

Lockwasher and Jam Nut



Part No.
415001-2



Part No.
414969-2

Type	Center Contact Plating	Body Plating	Dielectric	Style	Kit Part No.
Front Mount	Gold	Nickel	PTFE	MIL Type	228216-1*
Rear Mount	Gold	Nickel	PTFE	MIL Type	228215-1*

*includes Jam Nut and Lockwasher

SMB Receptacle Jack

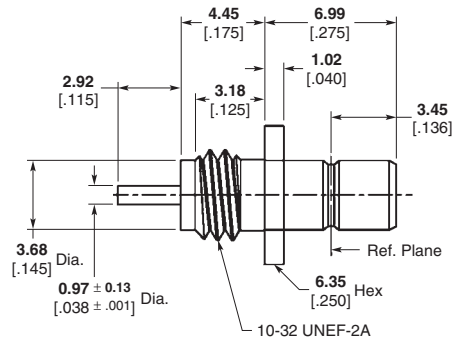

Type	Center Contact Plating	Body Plating	Dielectric	Style	Part No.
Front Mount	Gold	Nickel	PTFE	MIL Type	414895-1

Note: Part Numbers are RoHS compliant except: ♦ Indicates non-RoHS compliant.

SMB Connectors, Mini 75 Ohm

Product Facts

- Industry standard for miniature 75 ohm SMB
- SMB offers snap-fit coupling for quick connect/disconnect
- Suitable for high density applications
- Fast easy cable assembly
- Low VSWR
- Connectors offer consistent mating and unmating forces
- Straight plugs and jacks are completely crimp terminated
- Low cost

Mini 75 ohm SMB connectors are ideally suited for circuit miniaturization in communication, broadband and switching equipment as well as a variety of other applications.

They offer the same low consistent mating/unmating force as Tyco Electronics standard SMB products and therefore, outer contact resistance values are maintained from connector to connector.

Standard military, commercial or Tyco Electronics tooling can be used to terminate these products. Cost effective assembly of the straight plugs is completed with a crimp center contact and hex crimp on the outer braid. Right-angle plugs have a hex crimp on the outer braid ferrule and bifurcated solder center contacts.



Electrical Characteristics

Impedance — 75 ohms

Frequency Range — 0 to 4.0 GHz

Insulation Resistance — 1000 megohms

Contact Current Rating — 1.5 amps DC max.

Mechanical Characteristics

Engagement Forces — Initial—14.0 lbs. [62.3 N] maximum engagement.
After 500 matings, 14.0 lbs. [62.3 N] maximum engagement.
Durability—500 cycles

Environmental Characteristics

Temperature Rating — -65°C to +165°C

SMB Connectors, Mini 75 Ohm (Continued)

Straight Plug

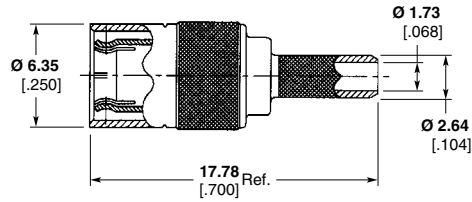

RG Cable	Center Contact Plating	Outer Contact Plating	Body Plating	Part No.
179, 187	Gold	Gold	Nickel	5415487-1
179, 187	Gold	Nickel	Nickel	5415487-2
RD 179	Gold	Nickel	Nickel	5415487-3

Right-Angle Plug

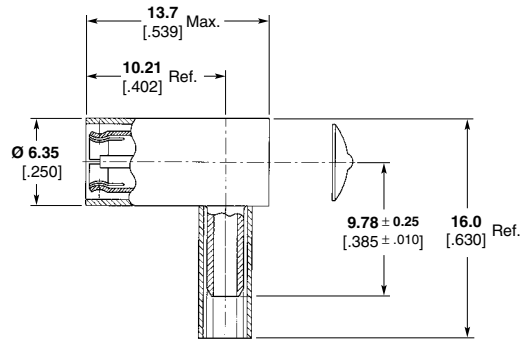

RG Cable	Center Contact Plating	Outer Contact Plating	Body Plating	Part No.
179, 187	Gold	Nickel	Nickel	5415484-1
179, 187	Gold	Gold	Nickel	5415484-2
RD 179	Gold	Gold	Nickel	5415484-3

Bulkhead Jack

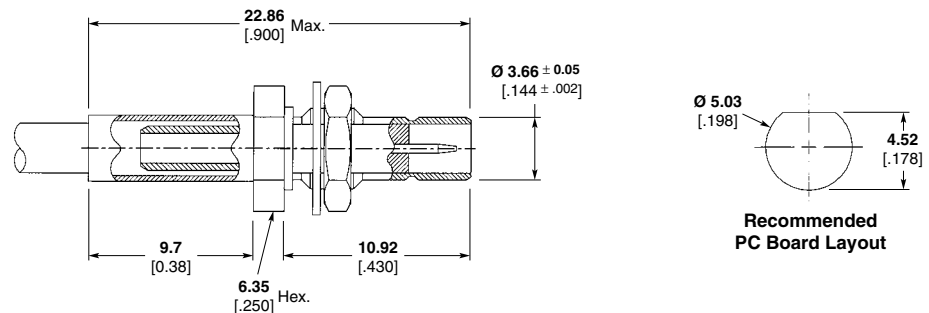

RG Cable	Center Contact Plating	Body Plating	Part No.
179, 187	Gold	Nickel	415500-1

Note: Part Numbers are RoHS compliant except: ♦ Indicates non-RoHS compliant.

SMB Connectors, Mini 75 Ohm (Continued)

Vertical PC Board Jacks

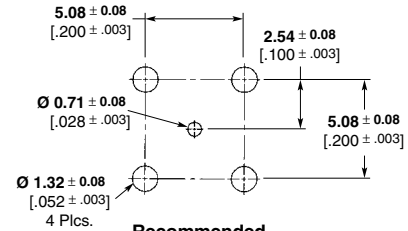
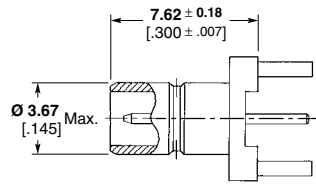

Recommended PC Board Layout

Leg Length	Center Contact Plating	Body Plating	Part No.
2.11 .083	Gold	Gold Flash	415504-2
3.05 .120	Gold	Gold	415504-3
3.05 .120	Gold	Gold Flash	415504-4

Right-Angle PC Board Jacks

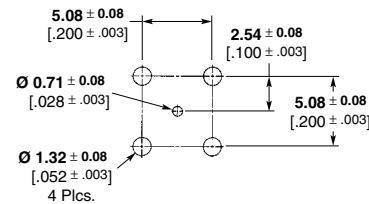
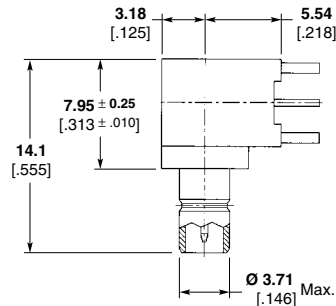

Recommended PC Board Layout

Leg Length	Center Contact Plating	Body Plating	Part No.
2.79 .110	Gold	Gold	415490-1
2.79 .110	Gold	Nickel	415490-2
2.11 .083	Gold	Gold	415490-3
2.11 .083	Gold	Nickel	415490-4

Right-Angle PC Board Bulkhead Jacks

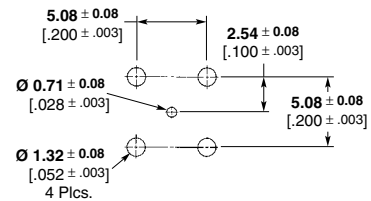
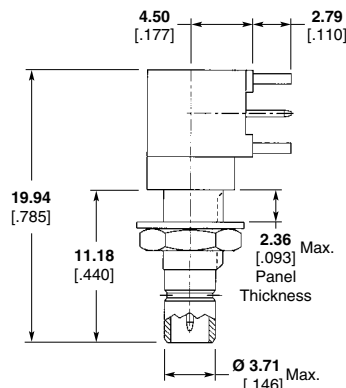

Recommended PC Board Layout

Leg Length	Center Contact Plating	Body Plating	Part No.
2.79 .110	Gold	Nickel	415377-1
2.79 .110	Gold	Gold	415377-2
2.79 .110	Gold	Gold	415377-5*

Note: Part Numbers are RoHS compliant except: ♦ Indicates non-RoHS compliant.

*Isolated.

SMB Connectors, 75 Ohm BT 43 (SMZ)

Product Facts

- Widely used in data transmission and telecommunication applications
- BT 43 connector developed from the SMB range and feature snap-on and latching variant
- Most BT 43 connectors are available as fully crimped connectors.
- BT 43 and 75 Ω connectors available in solder and crimp versions

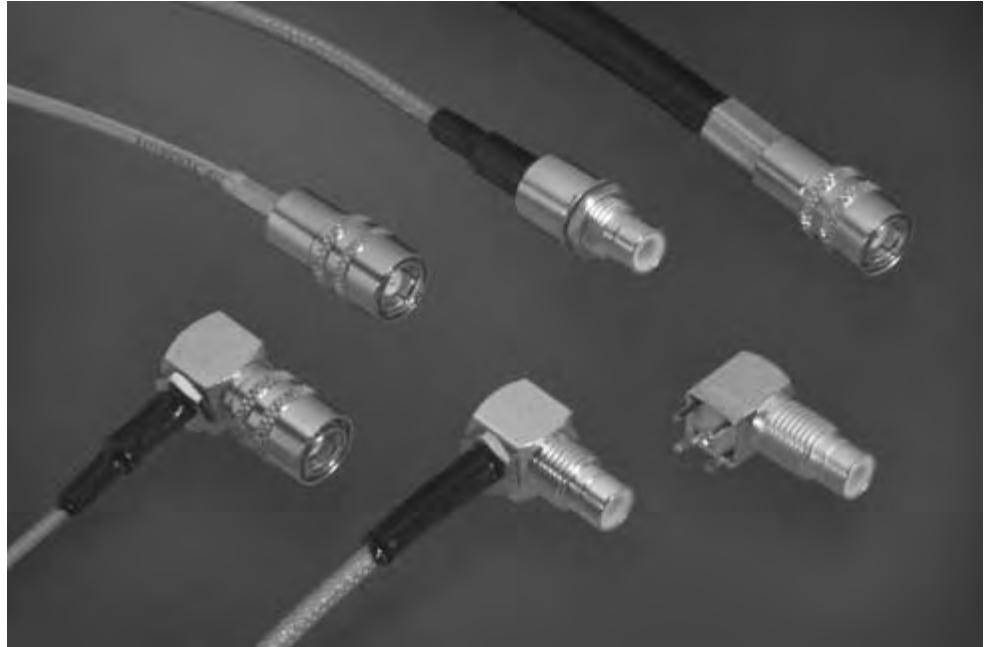

The Tyco Electronics range of 75 ohm SMB (SMZ) connectors are designed to meet the increasing demands of the Telecommunications market, and are designed in accordance with BS9210 F0022.

Specifications

Max working voltage (dc) — 500 V

Max proof voltage (dc) — 1.5 kV

Contact resistance (inner) — 5 milliohm

Contact resistance (outer) — 1 milliohm

Bodies and other parts — Brass

Female center contacts —

Copper Alloy

Male center contacts —

Copper Alloy

Outer contacts — BeCu

Plating —

Contacts and critical surfaces — Gold

Other parts — Nickel

Insulators — P.T.F.E.

SMB Connectors, 75 Ohm BT 43 (SMZ) (Continued)

Straight Plugs, Snap-On

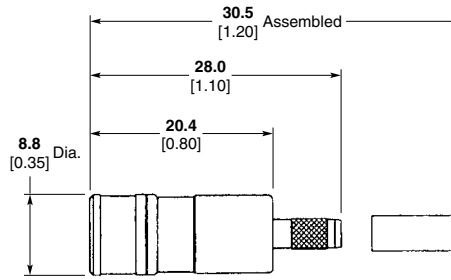

Cable Type	Termination Method		Body Plating	Part No.
	Inner	Outer		
RG 179B/U	Crimp	Crimp	Selective Gold	1311097-1
BT2002	Crimp	Crimp	Selective Gold	1311098-1

Straight Plugs, Latching, Crimp/Crimp

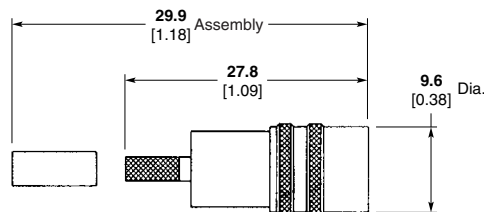

Cable Type	Body Plating	Part No
RG 179B/U	Selective Gold	1311099-1
BT2003	Selective Gold	1311100-1
BT2002	Selective Gold	1311101-1
BT2001	Selective Gold	1311696-1
BT3002, TZC75024	Selective Gold	1311102-1
RG 59B/U, RG 140/U, URM90	Selective Gold	1313507-1

Note: Part Numbers are RoHS compliant except: ♦ Indicates non-RoHS compliant.

SMB Connectors, 75 Ohm BT 43 (SMZ) (Continued)

**Right-Angle Socket,
Snap-On, Solder/Crimp**

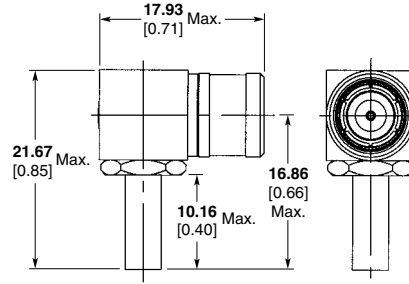

Cable Type	Body Plating	Part No
RG 179B/U	Selective Gold	1311103-1
BT3002, TZC75024	Selective Gold	1311104-1

**Right-Angle Socket,
Latching, Solder/Crimp**

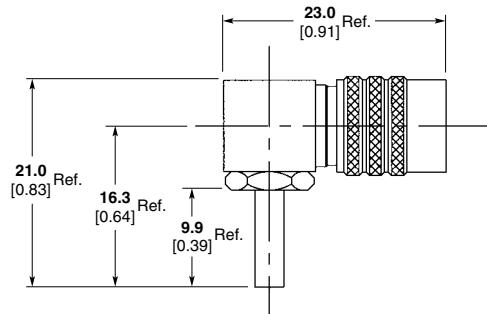

Cable Type	Body Plating	Part No
RG 179B/U	Selective Gold	1311106-1
BT2003	Selective Gold	1311698-1
BT3002, TZC75024	Selective Gold	1311111-1
RG 59B/U, RG 140/U	Selective Gold	1313508-1

**Straight Free Plug,
Crimp/Crimp**

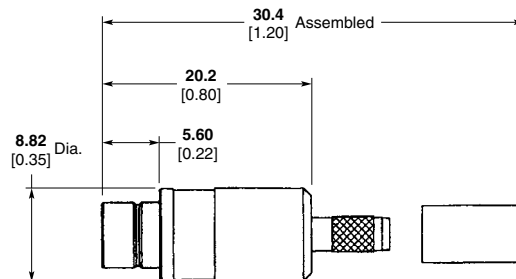

Cable Type	Body Plating	Part No
RG 179B/U	Selective Gold	1408041-1

Note: Part Numbers are RoHS compliant except: ♦ Indicates non-RoHS compliant.

SMB Connectors, 75 Ohm BT 43 (SMZ) (Continued)

Straight Bulkhead Plug

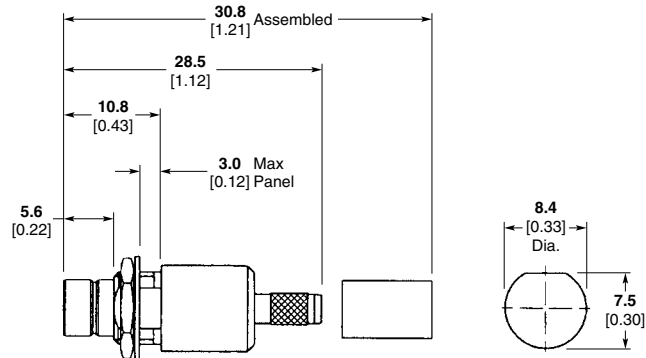

Mounting Detail

Cable Type	Termination Method		Body Plating	Part No.
	Inner	Outer		
RG 179B/U	Crimp	Crimp	Selective Gold	1311120-1
BT500B, BT2003, BT2003A	Crimp	Crimp	Selective Gold	1311701-1
BT3002, TZC75024	Crimp	Crimp	Selective Gold	1311122-1

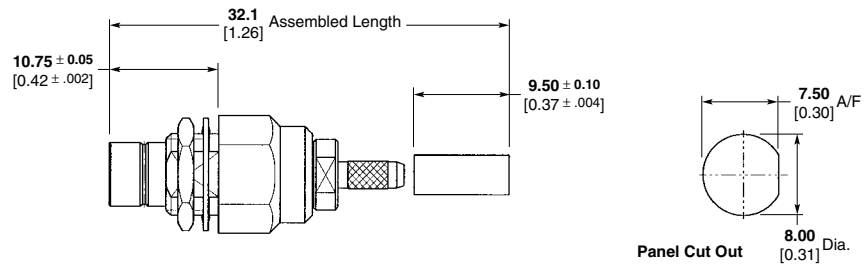

Panel Cut Out

Cable Type	Termination Method		Body Plating	Part No.
	Inner	Outer		
3M: 043, 031C, CS4456, Gore: GCX	Crimp	Crimp	Selective Gold	1313511-1

Right-Angle Bulkhead Plug, Solder/Crimp

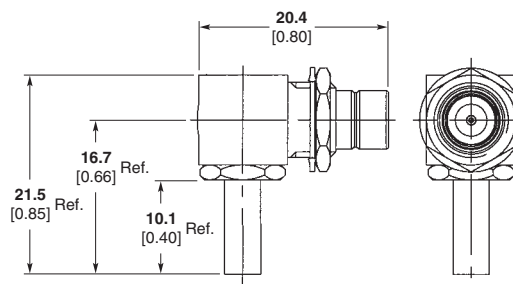

Cable Type	Body Plating	Part No
RG 179B/U	Selective Gold	1311115-1

Note: Part Numbers are RoHS compliant except: ♦ Indicates non-RoHS compliant.

SMB Connectors, 75 Ohm BT 43 (SMZ) (Continued)

DDF Plug, Crimp/Crimp

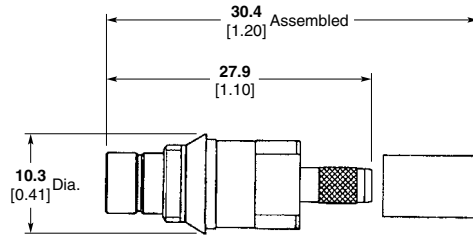

Cable Type	Body Plating	Part No
RG 179B/U	Selective Gold	1327083-1
BT2003	Selective Gold	1311117-1
BT2002	Selective Gold	1311700-1
B2001	Selective Gold	1313883-1
BT3002, TZC75024	Selective Gold	1311118-1
RG 59B/U, RG 140/U, URM90	Selective Gold	1313887-1

DDF Plug, Crimp/Crimp

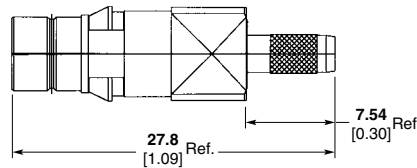

Cable Type	Body Plating	Part No
RD179, 124431 (Filotex), 1366 (Orebro), K02253D-1, K02253-2 (Shuner)	Selective Gold	1314422-1

PC Board Plug 43/1D

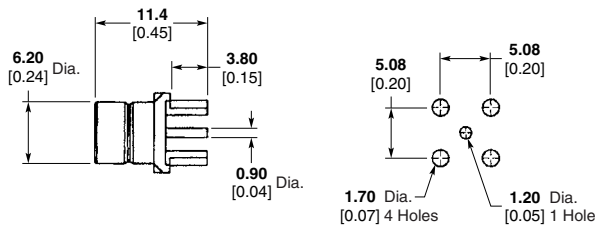

Mounting Detail

Body Plating	Part No.
Selective Gold	1311125-1

PC Board Plug 43/1E

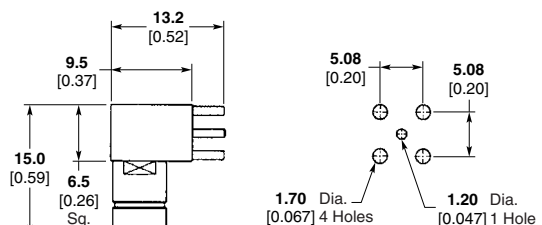

Mounting Detail

Body Plating	Part No.
Selective Gold	1314103-1

Right-Angle PC Board Plug

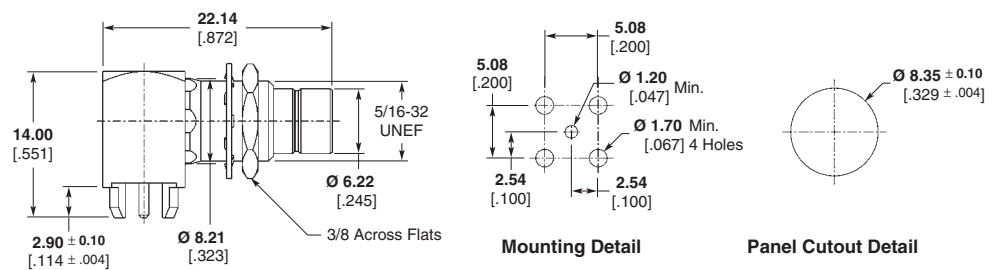

Mounting Detail

Panel Cutout Detail

Part No. 1314102-1

Note: Part Numbers are RoHS compliant except: ♦ Indicates non-RoHS compliant.

SMB Connectors, 75 Ohm BT 43 (SMZ) (Continued)

**Straight Adapter
Plug-Plug**

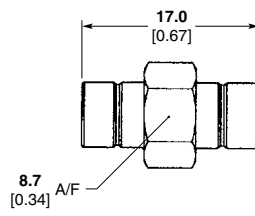

Part No. 1313364-1

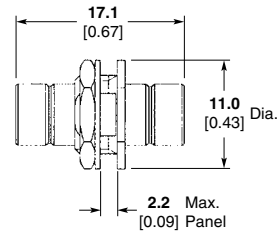

Part No. 1311127-1

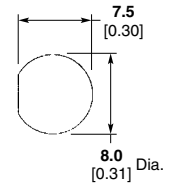

Mounting Detail

Body Plating	Part No.
Selective Gold	1313364-1
Selective Gold	1311127-1

Tester 430A

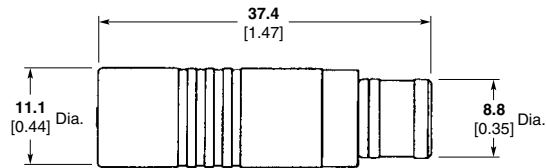

Body Plating	Part No.
Selective Plating	6-1311703-1

Extraction Tool 65A

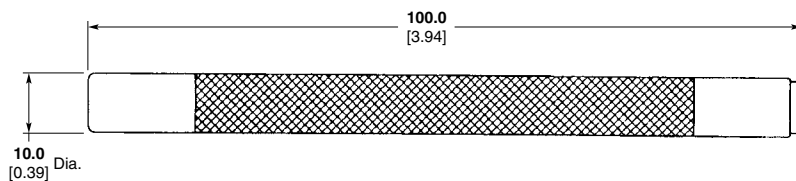

Part No.
1311164-1 ◆

Note: Part Numbers are RoHS compliant except: ◆ Indicates non-RoHS compliant.

SMB Connector Crimp Tooling

50 Ω/75 Ω

RG/U Cable	Commercial Connector Tooling						MIL Type Connector Tooling						
	Center Contact Crimp Tooling			Braid Crimp Tooling			Center Contact Crimp Tooling			Braid Crimp Tooling			
	Dies for Tyco Electronics PRO-CRIMPER Hand Tool Number	MIL-C-22520/2-01 Tool DANIELS* Positioner	Position	Dies for Tyco Electronics PRO-CRIMPER Hand Tool Number	Position	MIL-C-22520/5-01 Tool DANIELS* Hex Crimp Die	DANIELS* Hand Tool	DANIELS* Positioner Number	Selector Position	Dies for Tyco Electronics PRO-CRIMPER Hand Tool Number	Position	DANIELS Hand Tool	Hex Die Across Flats
178, 178A, 178B, 196, 196A	58489-1	Female-K699 Male-K727	4	58489-1	A&B	Y624	AFM8	Female-K699 Male-K727	4	58483-1	A	HX4-1637	2.67 .105
Double Braid 178, 196	—	—	—	—	—	—	AFM8	Female-K699 Male-K727	4	58483-1	B	HX4-1637	3.25 .128
174, 316 188, 188A	58489-1	Female-K699 Male-K727	4	58489-1	A	Y444	AFM8	Female-K699 Male-K727	4	58483-1	B	HX4-1637	3.25 .128
Double Braid 174, 316, 188	58489-1	Female-K699	4	58489-1	C	Y196 Location A	AFM8	Female-K699	4	58483-1	C	HX4-1637	3.84 .151
Double Braid 174, 316, 188	58489-1	Male-K727	4	58489-1	C	Y196 Location A	AFM8	Solder	—	58483-1	B	HX4-1637	3.25 .128
179, 179A 179B, 161, 187, 187A, BELDEN 9221	58489-1	Female-K699	4	58489-1	A	Y444	AFM8	Female-K699	4	58483-1	B	HX4-1637	3.25 .128
179, 179A 179B, 161, 187, 187A, BELDEN 9221	58489-1	Male-K727	4	58489-1	A	Y444	—	Solder	—	58483-1	B	HX4-1637	3.25 .128
180, 180A 180B	—	—	—	—	—	—	—	Solder	—	58483-1	C	HX4-1637	3.84 .151
Mini SMB 75 ohm													
179, 187	—	Female-K699	—	58483-1	B	HX4-1637	—	—	—	—	—	—	—
179, 187	—	Solder Center Contact	—	58483-1	B	HX4-1637	—	—	—	—	—	—	—

Note: All 75 ohm SMB connectors have a solder center contact.

* DANIELS Manufacturing Corporation Telephone: 407-855-6161
6103 Anno Avenue FAX: 407-855-6884
Orlando, Florida 32809

Note: Equivalent military tool part numbers—
M22520/5-01 – DANIELS Hand Tool HX4
M22520/5-33 – DANIELS Die Set Y136
M22520/5-37 – DANIELS Die Set Y138
M22520/5-41 – DANIELS Die Set Y140
M22520/5-03 – DANIELS Die Set Y196
M22520/2-01 – DANIELS Hand Tool AFM8

BELDEN is a trademark of Belden Wire and Cable Company.

DANIELS is a trademark of Daniels Manufacturing Corporation.

Note: Part Numbers are RoHS compliant except: ♦ Indicates non-RoHS compliant.

单击下面可查看定价，库存，交付和生命周期等信息

[>>TE Connectivity\(泰科\)](#)