

REVISIONS					
P	LTR	DESCRIPTION	DATE	DWN	APVD
G1		ECR-19-013959	06SEP2019	A.L	H.L

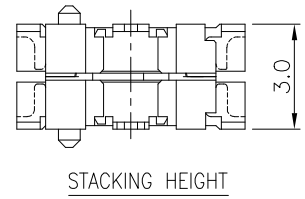

- NOTES:
- MATERIAL:
 - 1.1 HOUSING: PA6T, UL94V-0; COLOR: NATURAL.
 - 1.2 CONTACTS: PHOSPHOR BRONZE.
 - 1.3 PEGS: BRASS.
 - FINISH:
 - CONTACTS: (SEE TABLE)
 - PLATING B : GOLD FLASH ON ENTIRE CONTACT.
 - PLATING C : 100μ" MIN. MATTE-TIN ON ENTIRE CONTACT. (WITH ENTIRE CONTACT UNDERPLATED 50μ" MIN. NICKEL.)
 - PEGS: 100μ" MIN. TIN OR MATTE-TIN OVER 50μ" MIN. NICKEL.
 - PART NUMBER OF MATING RECEPTACLE: X-1775013-X
 - REFLOW SOLDER CAPABLE TO 260°C AS PER TEC-109-201, CONDITION B.
 - SUBSTANCE RESTRICTIONS FOR LOW HALOGEN (BY WEIGHT):
 - BROMINE (Br) ≤ 900 PPM (0.09%)
 - CHLORINE (Cl) ≤ 900 PPM (0.09%)
 - TOTAL CONCENTRATION OF (Cl) + (Br) ≤ 1500 PPM (0.15%)

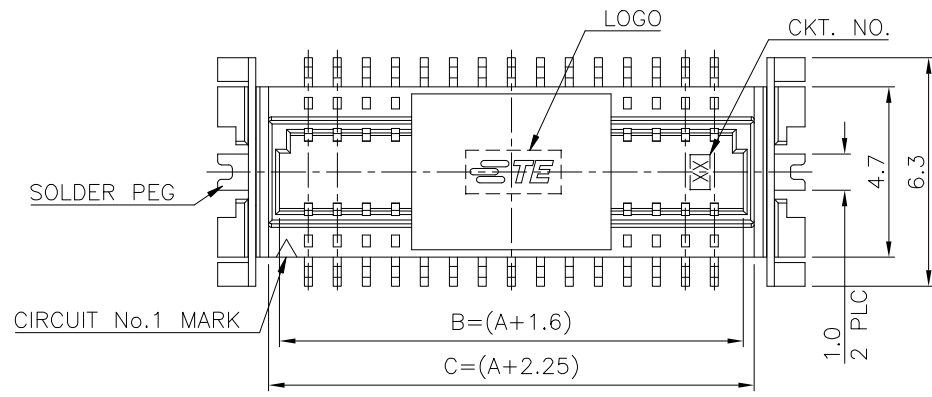
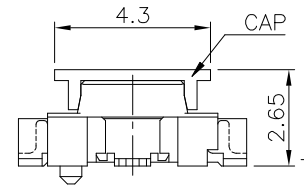
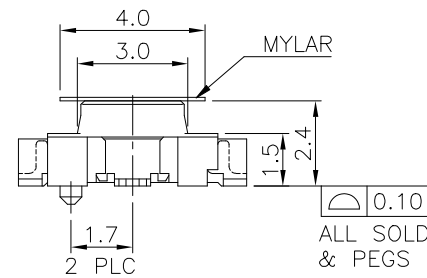
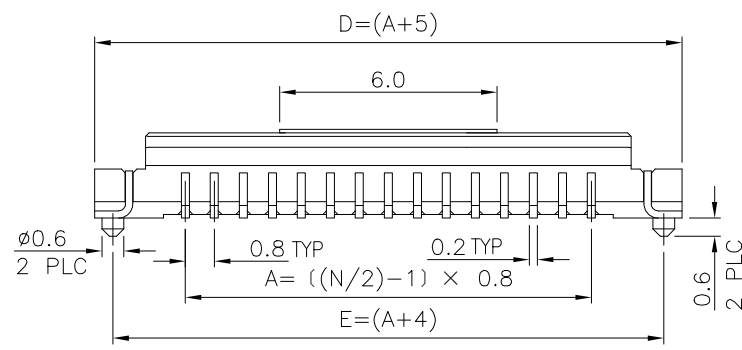

(1775014-1 & 5-1775014-4 ARE OBSOLETED)

CAP OR MYLAR	C	8	9	6.25	5.6	4.0	12	5-1775014-4
MYLAR	B	12.8	13.8	11.05	10.4	8.8	24	1775014-2
		8	9	6.25	5.6	4.0	12	1775014-1
CAP OR MYLAR	CONTACT PLATING	E	D	C	B	A	NO. OF CONTACTS	PART NUMBER
DIMENSIONS								

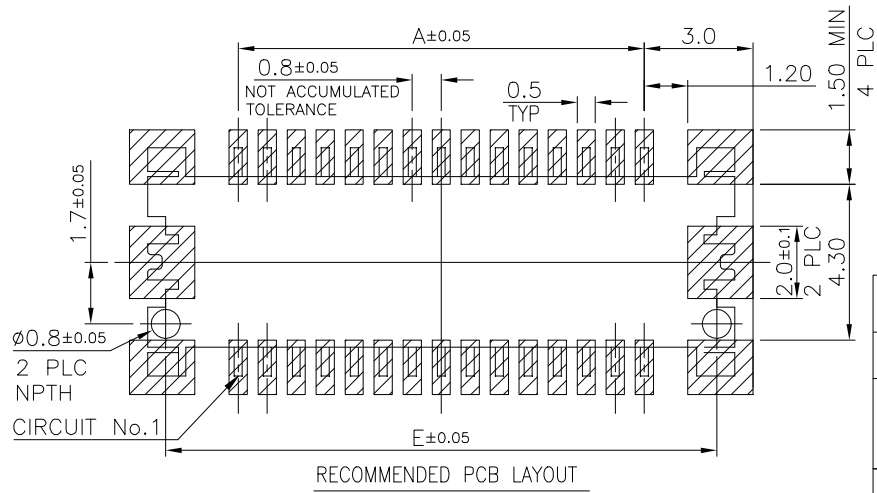

FOR 5-1775014-4 ONLY

THIS DRAWING IS A CONTROLLED DOCUMENT.

DIMENSIONS: mm	TOLERANCES UNLESS OTHERWISE SPECIFIED:	DWN A. WU 05FEB2013	TE Connectivity BOARD-TO-BOARD CONNECTOR, 0.8mm PITCH, FINE-STACK 3H. PLUG
	0 PLC ± -	CHK S. CHIEN 05FEB2013	
	1 PLC ± 0.3	APVD W. KODAMA 05FEB2013	
	2 PLC ± 0.2	NAME	
MATERIAL	FINISH	PRODUCT SPEC 108-57488	SIZE CAGE CODE DRAWING NO RESTRICTED TO
		APPLICATION SPEC	A3 00779 C=1775014
		WEIGHT 0	SCALE 7:1 SHEET 1 OF 2 REV G1
		CUSTOMER DRAWING	

THIS DRAWING IS UNPUBLISHED.

RELEASED FOR PUBLICATION

ALL RIGHTS RESERVED.

© COPYRIGHT - By -

REVISIONS

P	LTR	DESCRIPTION	DATE	DWN	APVD
-	-	SEE SHEET 1	-	-	-

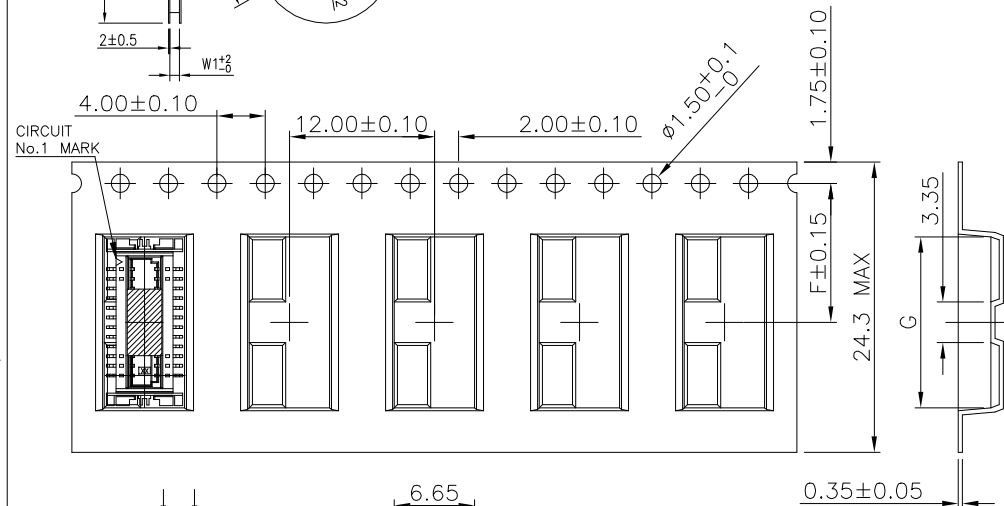
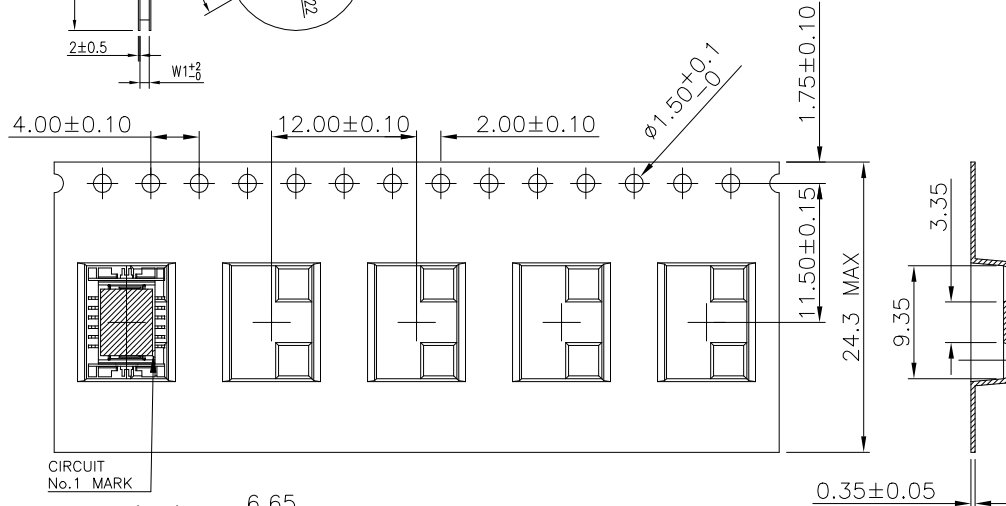
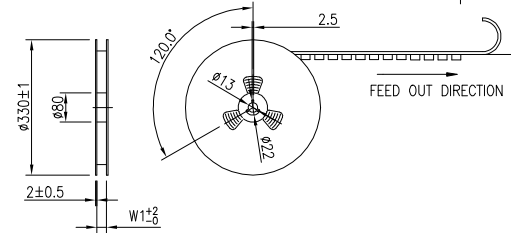
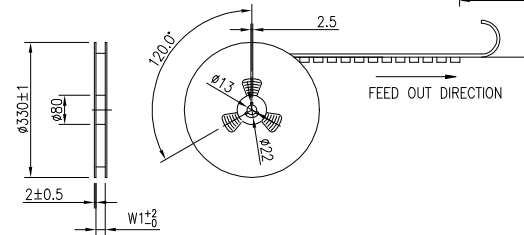
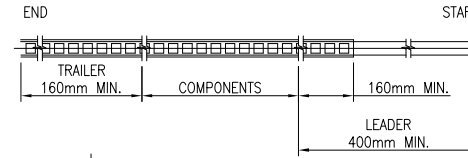
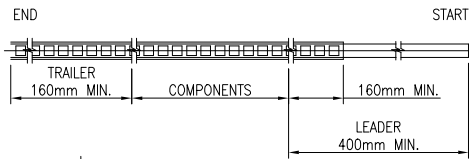

CIRCUIT No.1 MARK

CIRCUIT No.1 MARK

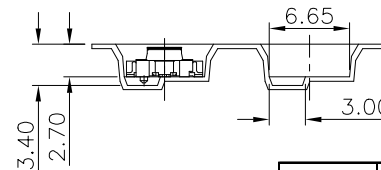
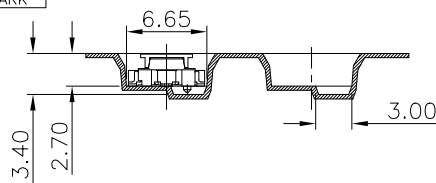

FOR 5-1775014-4 ONLY

FOR 12, 24 CONTACTS (WITH OR WITHOUT MYLAR)

NOTES:

- MATERIAL:
BOX: FIBREBOARD, CORRUGATED, DOUBLE WALL.
COVER TAPE: PET, TRANSPARENT COLOR.
CARRIER TAPE: POLYSTYRENES, BLACK COLOR.
REEL: PAPER, BROWN COLOR.
BAG: POLYETHYLENES, TRANSPARENT COLOR.
- EACH BAG SHALL BE INCLUDED DESICCANT.
- PEELING STRENGTH: 0.1~1.3 N (10~130 GRAMS).
- PEELING SPEED: 300 mm/min.

1500	24.40	24.00	14.15	11.50	24
1500	24.40	24.00	9.35	11.50	12
PCS / TAPE	W1	W	G	F	NO. OF CONTACTS
DIMENSIONS					

THIS DRAWING IS A CONTROLLED DOCUMENT.

DIMENSIONS: mm

TOLERANCES UNLESS OTHERWISE SPECIFIED:

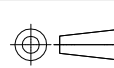

0 PLC	± -
1 PLC	± 0.3
2 PLC	± 0.2
3 PLC	± 0.15
4 PLC	± -
ANGLES	± 2'

MATERIAL

FINISH

DWN	A. WU	05FEB2013
CHK	S. CHIEN	05FEB2013
APVD	W. KODAMA	05FEB2013
PRODUCT SPEC	108-57488	
APPLICATION SPEC	-	
WEIGHT	0	
CUSTOMER DRAWING		

TE Connectivity

BOARD-TO-BOARD CONNECTOR, 0.8mm PITCH, FINE-STACK 3H. PLUG

SIZE	CAGE CODE	DRAWING NO	RESTRICTED TO
A3	00779	G=1775014	-

SCALE	SHEET	REV
7:1	2 OF 2	G1

单击下面可查看定价，库存，交付和生命周期等信息

[>>TE Connectivity\(泰科\)](#)