

THIS DRAWING IS UNPUBLISHED. RELEASED FOR PUBLICATION  
 © COPYRIGHT - BY TYCO ELECTRONICS CORPORATION. ALL RIGHTS RESERVED.

LOC	DIST	REVISIONS					
H	-	P	LTR	DESCRIPTION	DATE	DWN	APVD
		A		DRAWING RELEASED PER ECR-11-017294	22AUG2011	JvdH	TdB

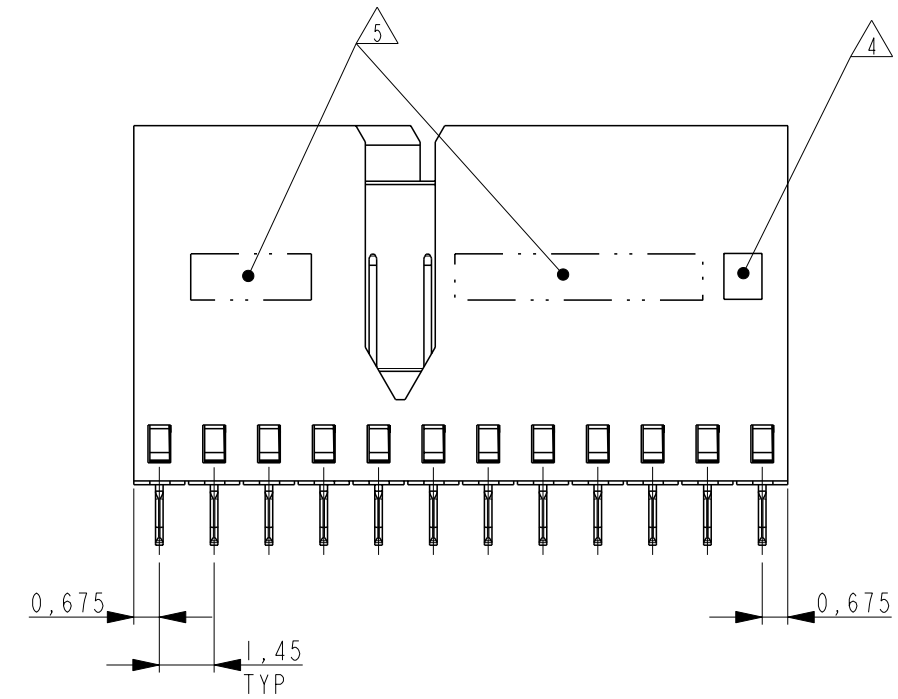
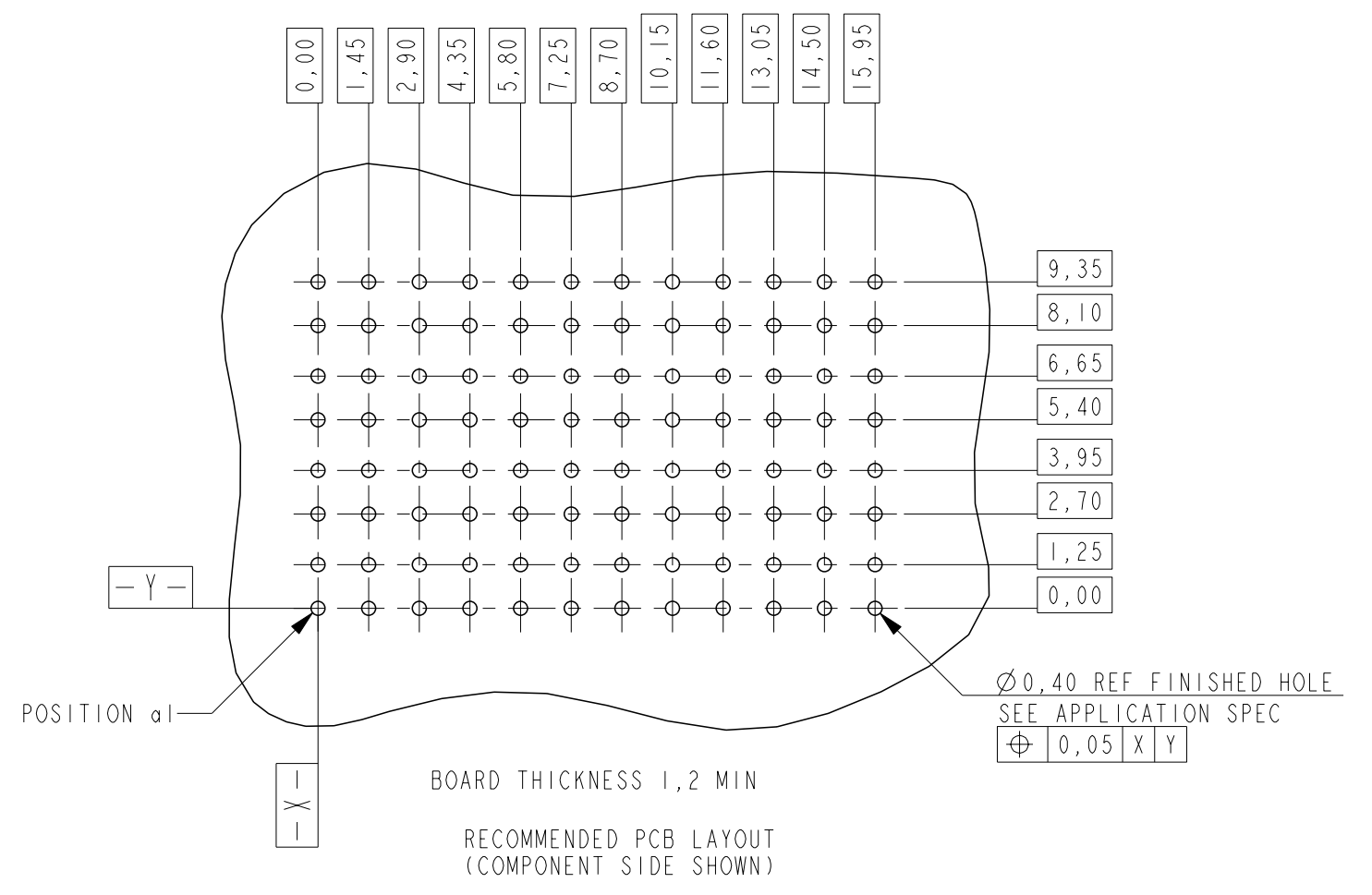
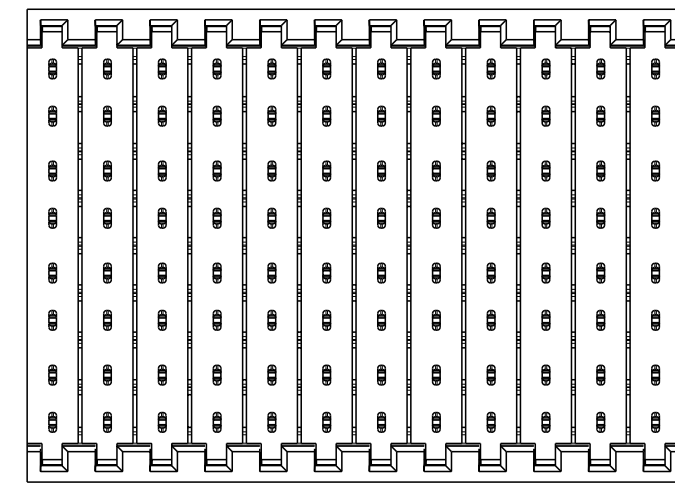
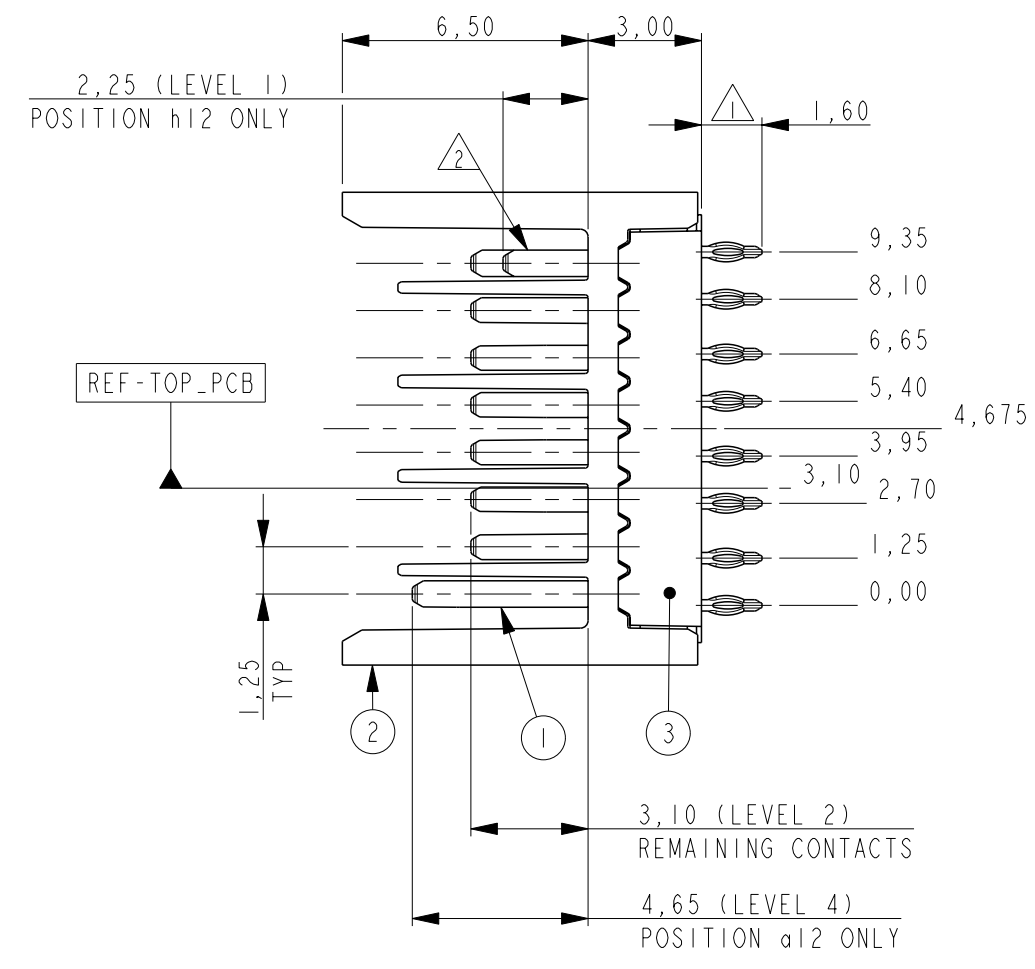
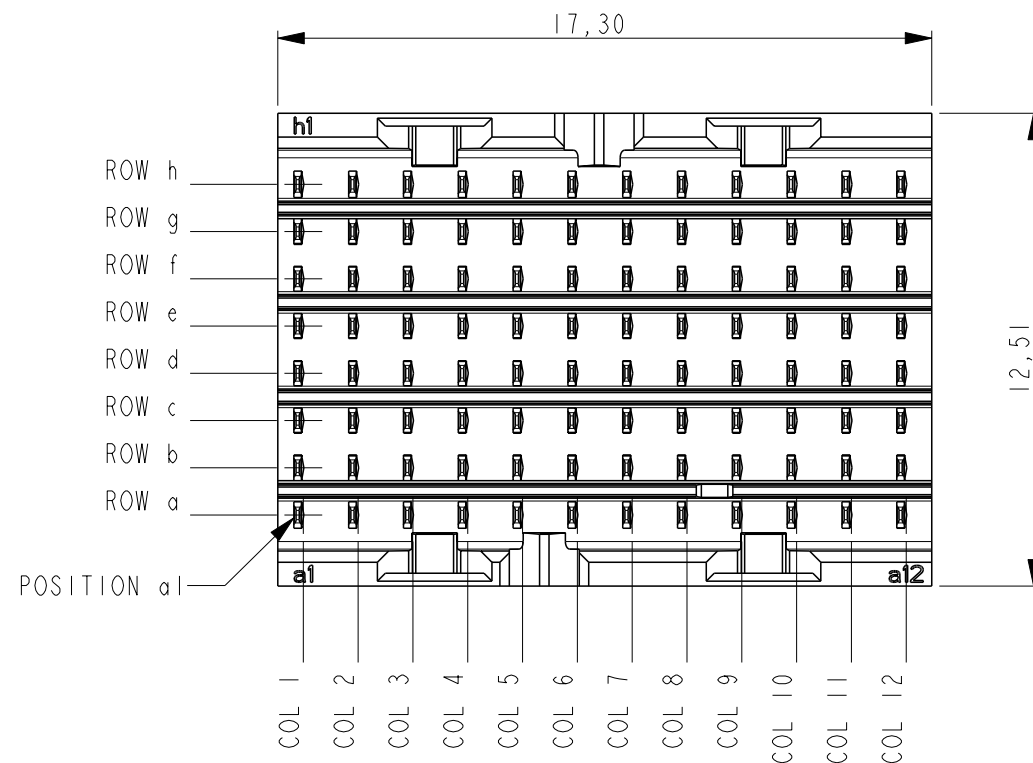
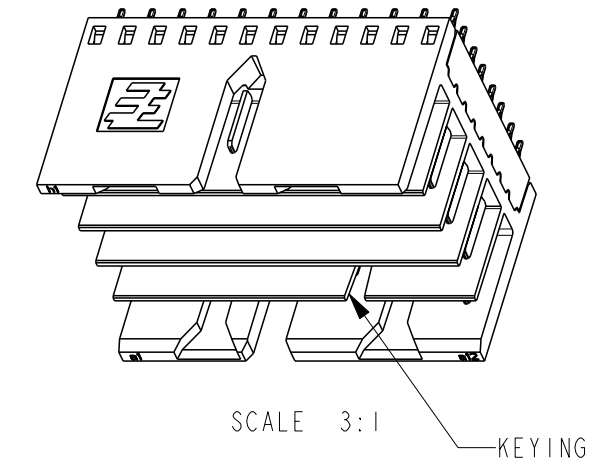
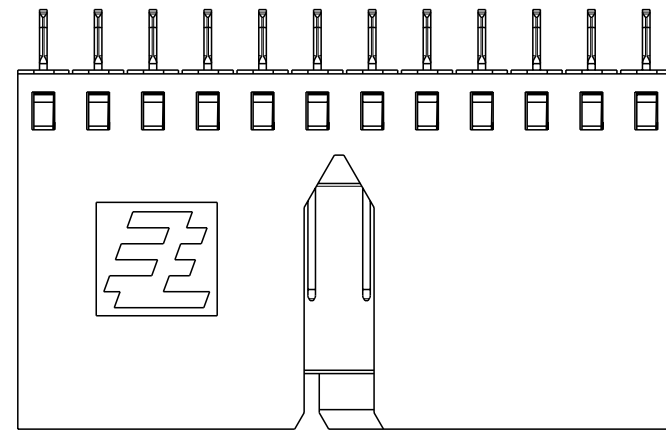

NOTES:

- △ PLATING: 0,5µm MIN. TIN OVER NICKEL.
- △ PLATING:

PARTNUMBER	PERFORMANCE LEVEL
1551099-1	PERFORMANCE LEVEL 1: CONNECTOR TESTED AND QUALIFIED AGAINST TELCORDIA GR-1217-CORE QUALITY LEVEL III: UNCONTROLLED ENVIRONMENT APPLICATIONS. SEE PRODUCT SPEC 108-19353
1551099-2	PERFORMANCE LEVEL 2: CONFORMS TO ALL TESTING ACCORDING PRODUCT SPEC 108-19320, -250 MATING CYCLES, 4 DAYS MIXED GAS TEST PER IEC 60068-2-60 METHOD I

- 3 CONSULT APPLICATION SPEC OR CONTACT TE CONNECTIVITY FOR PERMISSIBLE CONTACT ASSIGNMENTS.
- △ BLACK SQUARE MARKING FOR LEVEL 4 PIN AT POSITION a12 AS INDICATED.
- △ CONNECTOR MARKED WITH PARTNUMBER AND DATE CODE.
- 6 FOR PC-BOARD ROUTING RECOMMENDATIONS SEE SPEC 114-19140

**PRODUCT HAS NOT COMPLETED QUALIFICATION TESTING**

THIS DRAWING IS A CONTROLLED DOCUMENT.		DWN Vahsa 09-Feb-2009
DIMENSIONS: mm		CHK R. Annokkee 09-Feb-2009
TOLERANCES UNLESS OTHERWISE SPECIFIED:		APVD Mark Westen 09-Feb-2009
0 PLC	±	PRODUCT SPEC
1 PLC	±	APPLICATION SPEC
2 PLC	±	114-19106
3 PLC	±	WEIGHT -
4 PLC	±	CUSTOMER DRAWING
ANGLES	±	
FINISH	±	

3	OVERMOLD	LCP 30% GF NATURAL
2	HOUSING	LCP 30% GF NATURAL
1	CONTACT	COPPER ALLOY
ITEM NO.	DESCRIPTION	MATERIAL
<b>STE</b> TE Connectivity		
NAME MALE CONNECTOR Z-PACK Slim UHD		
SIZE	CAGE CODE	DRAWING NO
A2	00779	C-1551099
RESTRICTED TO	SCALE 5:1	SHEET 1 OF 1
		REV A

单击下面可查看定价，库存，交付和生命周期等信息

[>>TE Connectivity\(泰科\)](#)