

REVISIONS				
P	LTR	DESCRIPTION	DATE	APVD
E2		REVISED PER ECO-15-014756	13OCT2015	DD JS

LEVER IN PRE-STAGE POSITION

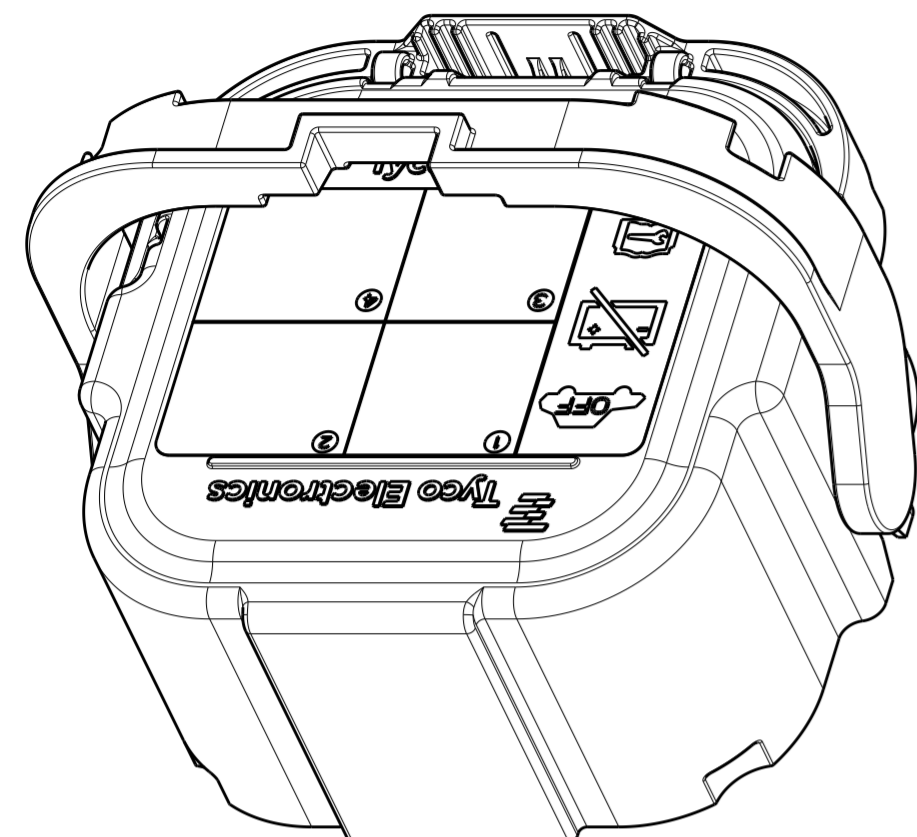

ISOMETRIC VIEW
SCALE 1:1

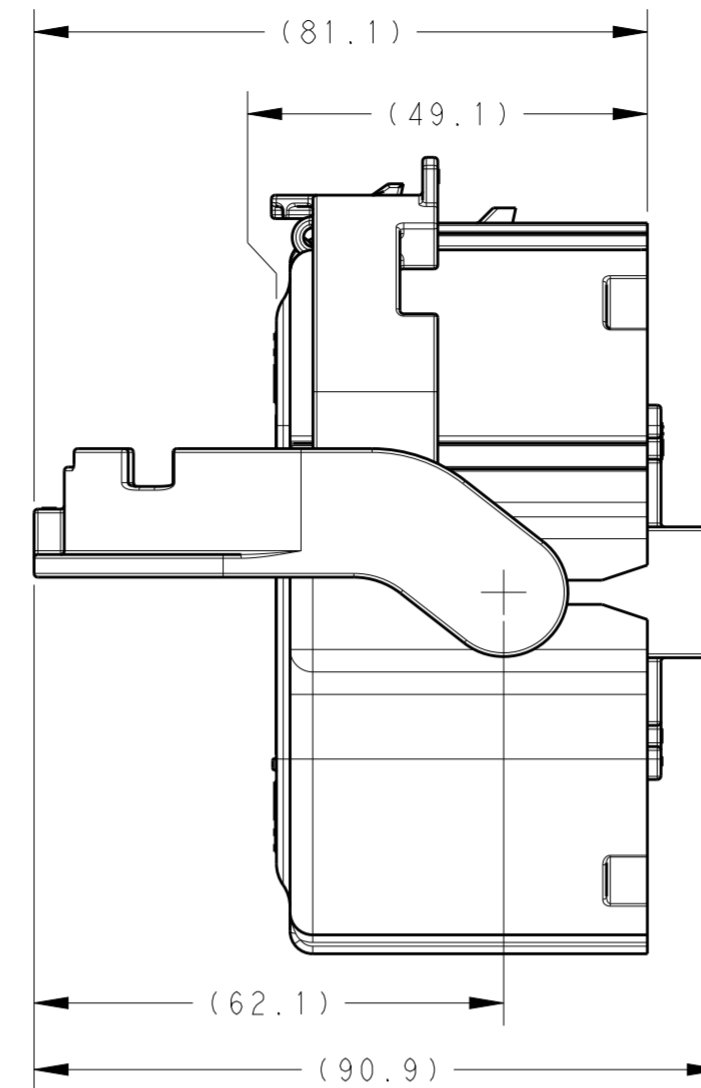
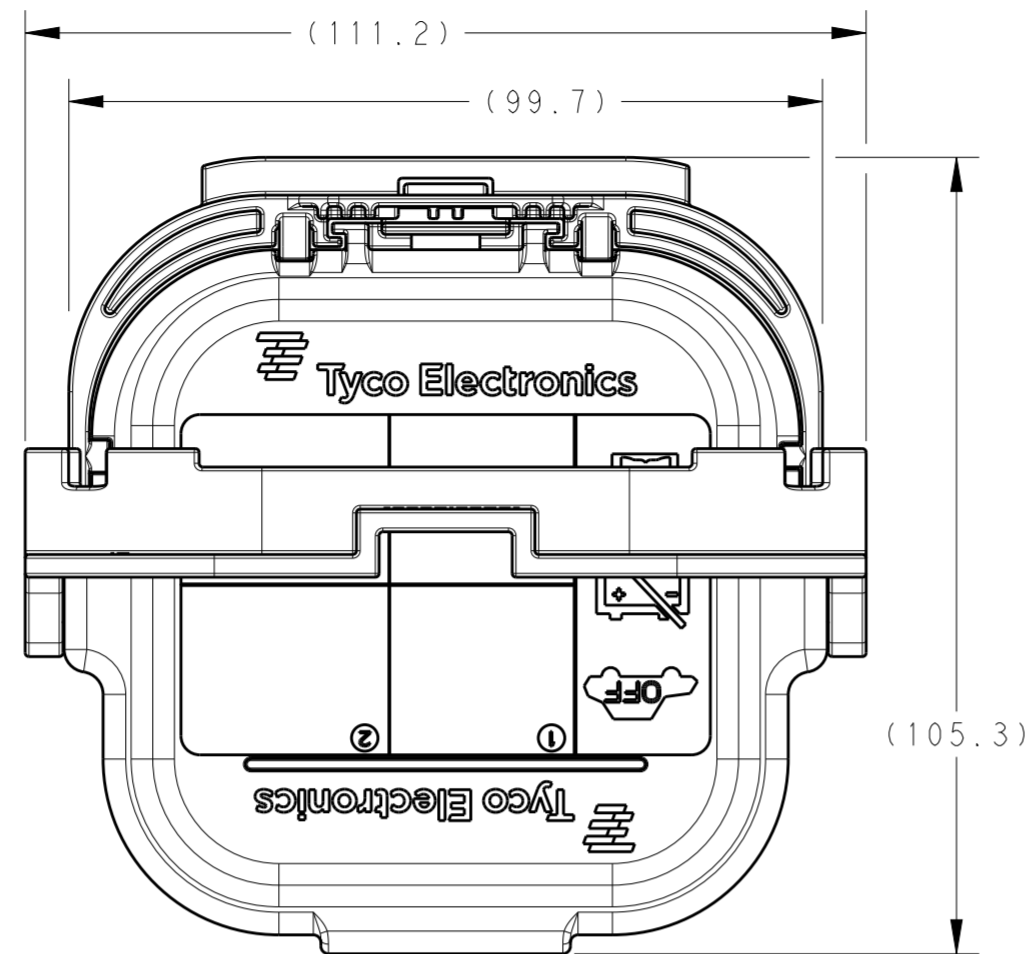

LEVER IN LOCKED POSITION

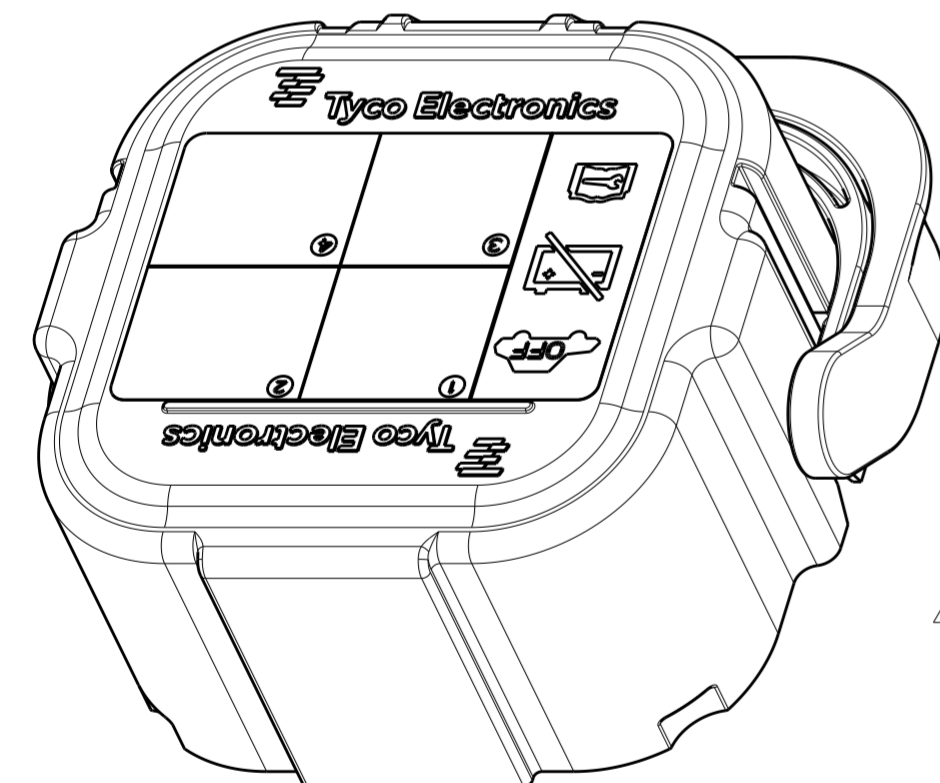

ISOMETRIC VIEW
SCALE 1:1

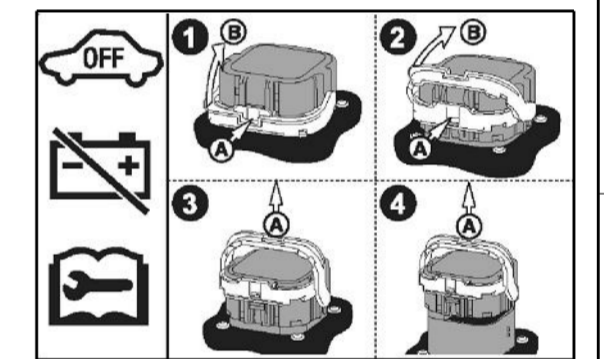
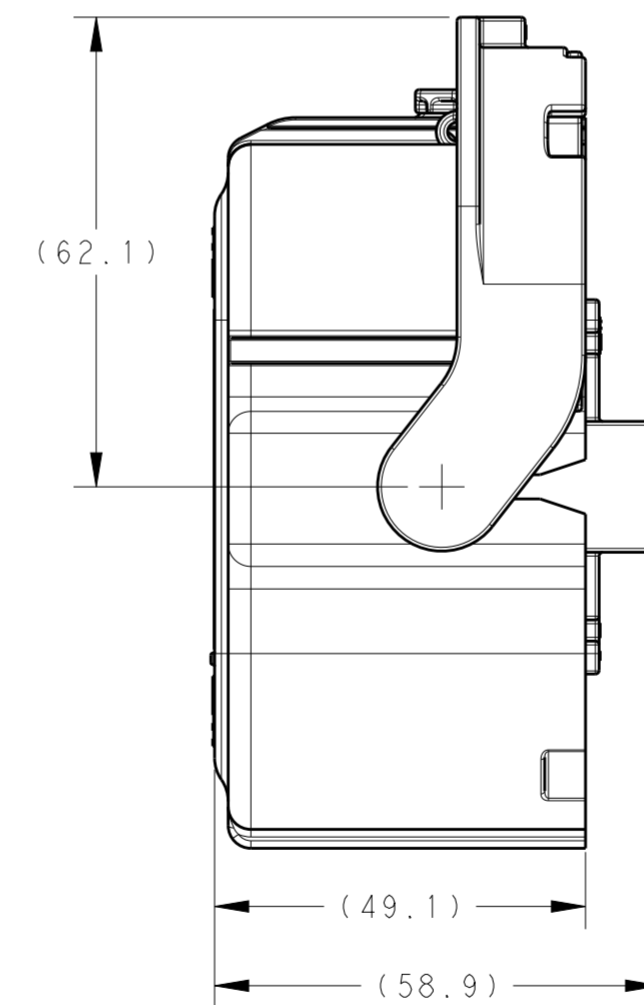
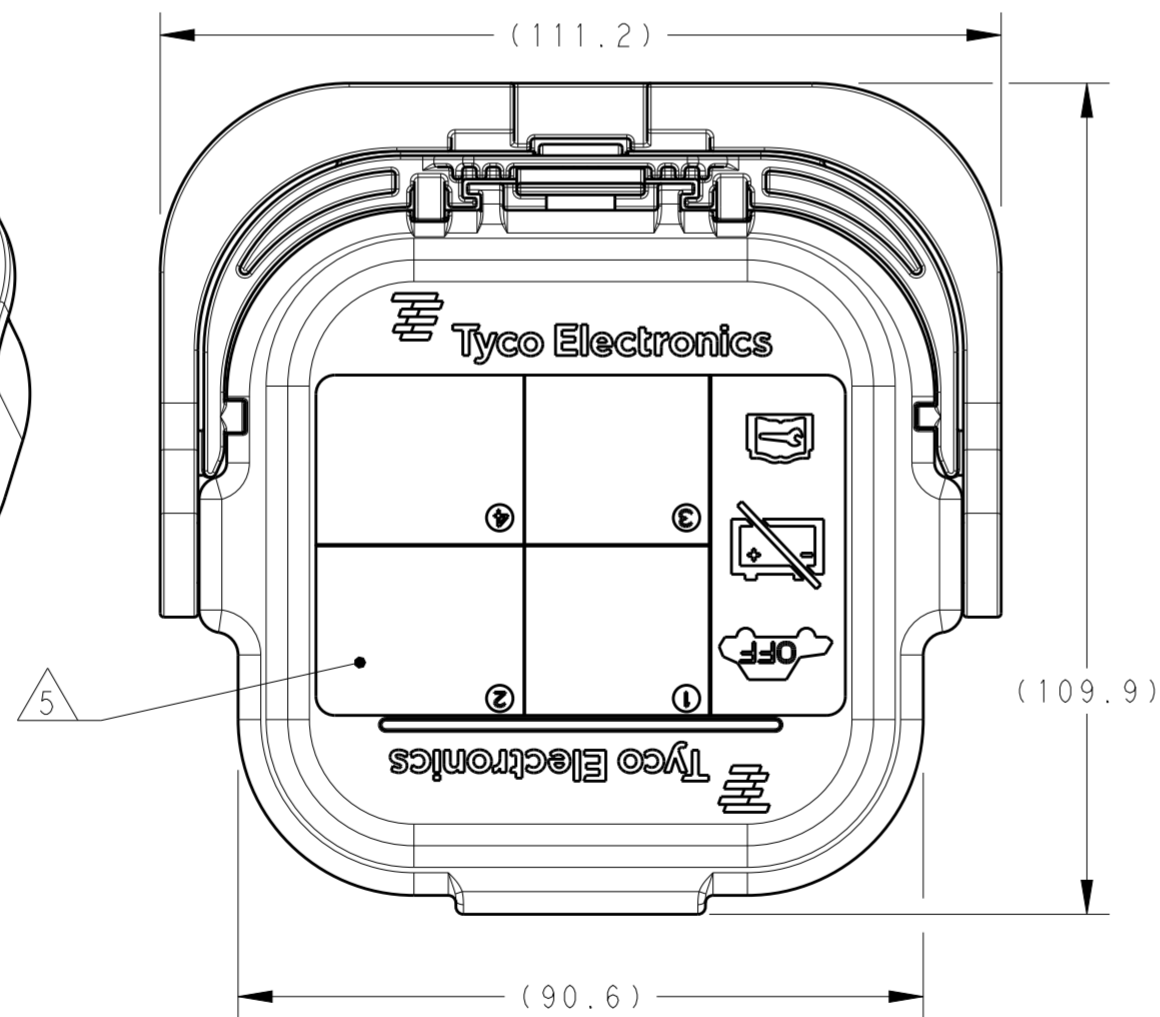

INNER LEVER COLOR	PART WEIGHT (g)	FUSE RATING	PART NO.
NATURAL/OFF-WHITE	261.25	SHUNT	2-2103212-7
NATURAL/OFF-WHITE	525.60	350A (EV)	2-2103212-2
BLACK	525.60	350A (EV)	2-2103212-1
NATURAL/OFF-WHITE	525.60	250A (EV)	1-2103212-9
NATURAL/OFF-WHITE	525.60	200A (EV)	1-2103212-8
BLACK	261.25	SHUNT	1-2103212-7
BLACK	525.60	350A	1-2103212-2
NATURAL/OFF-WHITE	525.60	350A	1-2103212-1
BLACK	525.60	250A	2103212-9
BLACK	525.60	200A	2103212-8

- ① INNER HOUSING MAY BE ASSEMBLED ROTATED 180° FROM AS SHOWN.
- ② ASSEMBLY / WORK INSTRUCTIONS: 408-10432
PRODUCT SPECIFICATION: 108-127000
APPLICATION SPECIFICATION: 501-127000
- ③ NOTE DELETED.
- ④ SEE TABLE AND SHEET 2 FOR FUSE RATINGS AND KEYING.
- ⑤ IMAGE FOR REFERENCE ONLY, SHOWS LABEL ORIENTATION.
- ⑥ ACTUAL APPEARANCE OF LABEL.

THIS DRAWING IS A CONTROLLED DOCUMENT. DIMENSIONING AND TOLERANCING PER ASME Y14.5M-2009

DIMENSIONS:	TOLERANCES UNLESS OTHERWISE SPECIFIED:
mm	
0 PLC	±
1 PLC	±
2 PLC	±
3 PLC	±
4 PLC	±
ANGLES	±
FINISH	

DWN	A BOYER	14JUL2011
CHK	A BOYER	14JUL2011
APVD	A GUANCO	14JUL2011
PRODUCT SPEC		②
APPLICATION SPEC		②
WEIGHT	SEE TABLE	
CUSTOMER DRAWING		

TE Connectivity		NAME	
		PLUG ASSEMBLY MANUAL SERVICE DISCONNECT	
SIZE	CAGE CODE	DRAWING NO.	RESTRICTED TO
A200779	C-2103212		
SCALE	1:1	SHEET	1 OF 2
REV	E2		

REVISIONS				
P	LTR	DESCRIPTION	DATE	APVD
-	-	SEE SHEET 1	-	-

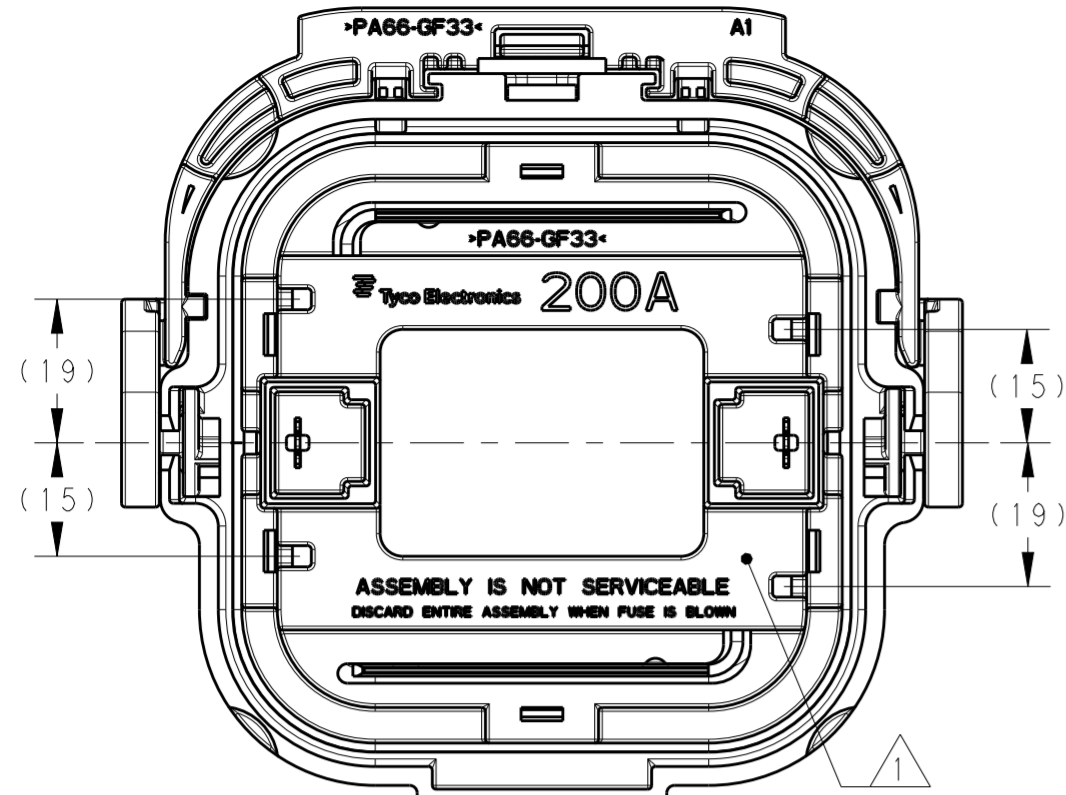

2103212-8 & 1-2103212-8
 FUSE RATING: 200A

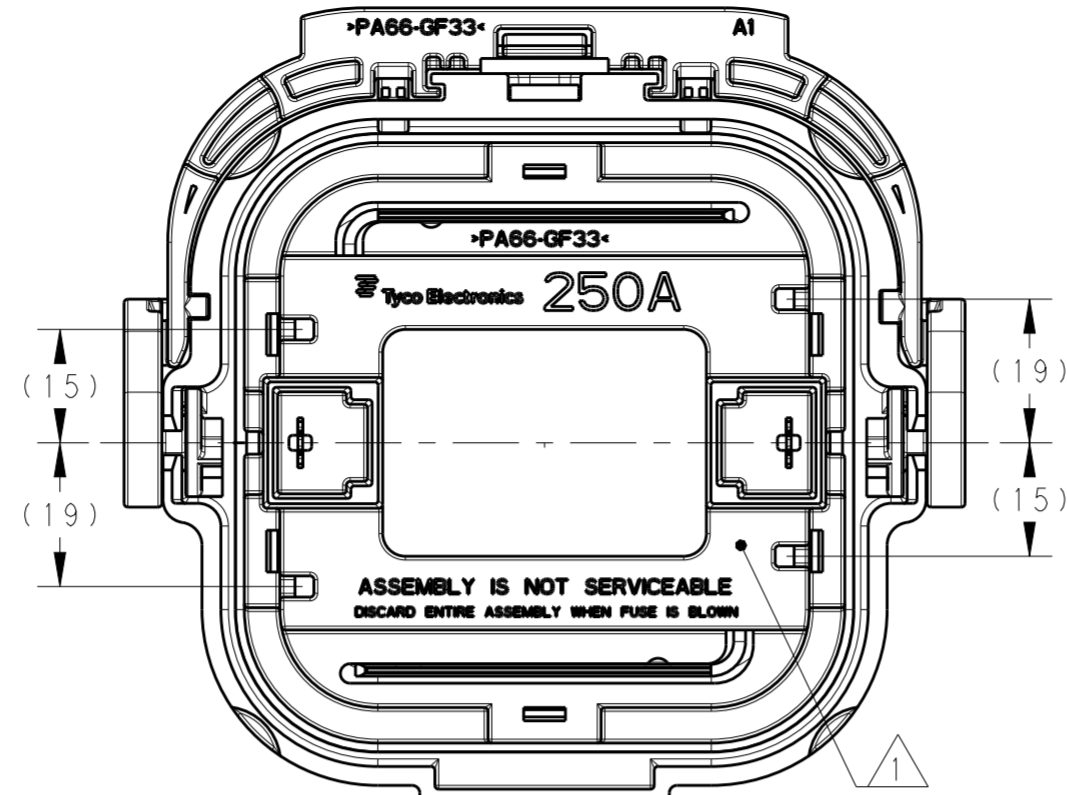

2103212-9 & 1-2103212-9
 FUSE RATING: 250A

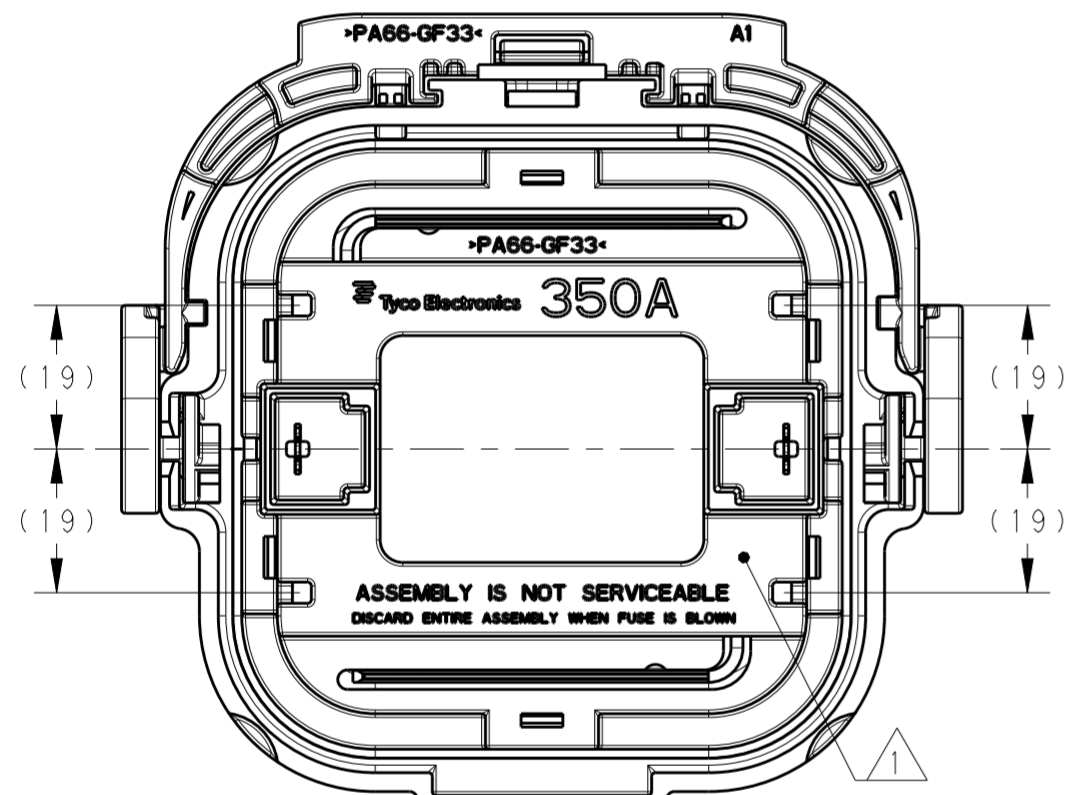

1-2103212-1, 1-2103212-2, 2-2103212-1
 & 2-2103212-2
 FUSE RATING: 350A

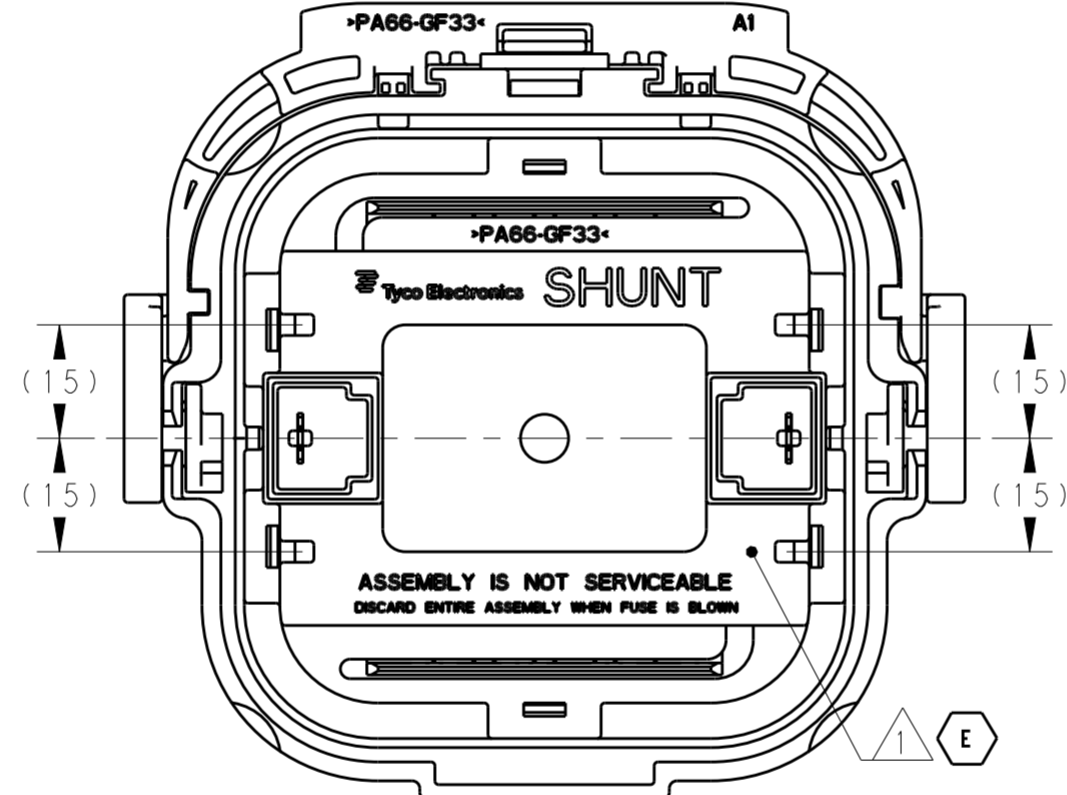

1-2103212-7 & 2-2103212-7
 SHUNT

THIS DRAWING IS A CONTROLLED DOCUMENT. DIMENSIONING AND TOLERANCING PER ASME Y14.5M-2009		DWN A BOYER 14 JUL 2011	 TE Connectivity	
DIMENSIONS: mm		CHK A BOYER 14 JUL 2011		
TOLERANCES UNLESS OTHERWISE SPECIFIED:		APVD A GUANCO 14 JUL 2011	NAME PLUG ASSEMBLY MANUAL SERVICE DISCONNECT	
0 PLC ± 1 PLC ± 2 PLC ± 3 PLC ± 4 PLC ± ANGLES ± FINISH -		PRODUCT SPEC 2	SIZE CAGE CODE DRAWING NO RESTRICTED TO	
MATERIAL -		APPLICATION SPEC 2	A200779 C-2103212	
-		WEIGHT SEE TABLE	SCALE 1:1 SHEET 2 OF 2 REV E2	
-		CUSTOMER DRAWING		

单击下面可查看定价，库存，交付和生命周期等信息

[>>TE Connectivity\(泰科\)](#)