

LOC		DIST		REVISIONS			
P	LTR	DESCRIPTION	DATE	DWN	APVD		
	B	REVISED PER ECO-17-005660	21APR2017	B. J	S. Y		

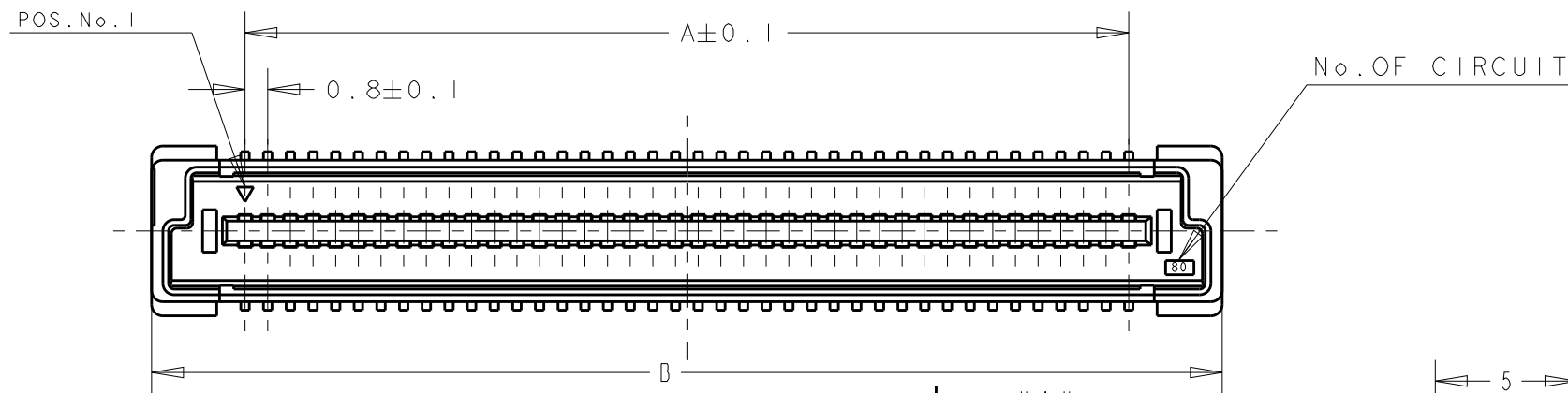

NOTES:

1. MATERIAL:  
 HOUSING: L.C.P. (HIGH TEMP. THERMOPLASTIC)  
 UL 94V-0, NATURAL.  
 CONTACT: BRASS.
2. FINISH:  
 CONTACT AREA: 0.00076 MIN GOLD ON  
 0.0013 MIN ALL OVER NICKEL.  
 SOLDERING AREA: 0.002 MIN MATTE-TIN.
3. POSITION SERIES: SEE TABLE.
4. CONN STACK HEIGHT COMBINE OF PLUG "Y" H VS REC "X" H.  
 STACK HEIGHT = Y + X - 5
5. CONNECTOR WITH BLACK HOUSING

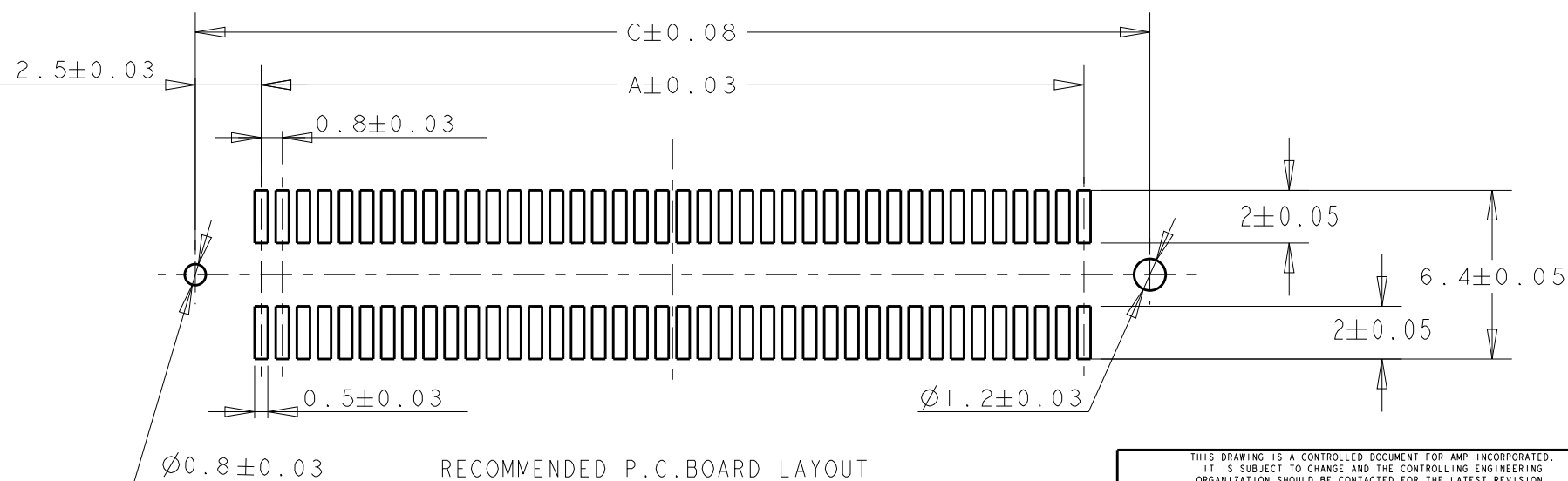
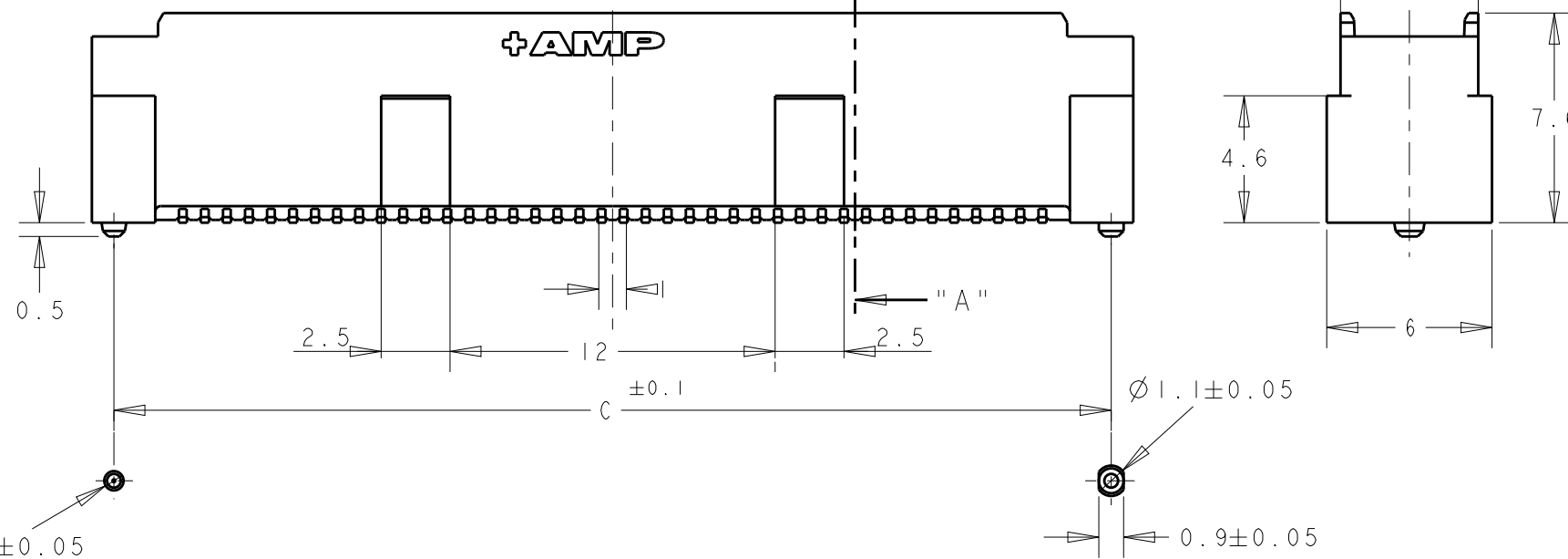

LOW HALOGEN

THIS DRAWING IS A CONTROLLED DOCUMENT FOR AMP INCORPORATED. IT IS SUBJECT TO CHANGE AND THE CONTROLLING ENGINEERING ORGANIZATION SHOULD BE CONTACTED FOR THE LATEST REVISION.

DIMENSIONS:	TOLERANCES UNLESS OTHERWISE SPECIFIED:
mm	
	0 PLC ±
	1 PLC ±0.30
	2 PLC ±0.25
	3 PLC ±0.20
	4 PLC ±
	ANGLES ±3°
MATERIAL	FINISH
1	2

DWN	FLORENCE TAN	14SEP04
CHK	ERIC TNG	
APVD	SEIFONG	
PRODUCT SPEC	108-5390	
APPLICATION SPEC	114-5254	
WEIGHT	-	
CUSTOMER DRAWING		

<b>AMP</b> Tyco Electronics Singapore	
NAME PLUG ASSY FOR FH 0.8 BTB CONNECTOR 8H 0.5 BOSS LENGTH (0.76um GOLD)	
SIZE	A3
CAGE CODE	00779
DRAWING NO	6123002
SCALE	4:1
SHEET	1 OF 2
REV	B

P/N SEE SHEET 2 OF 2

THIS DRAWING IS UNPUBLISHED. RELEASED FOR PUBLICATION .19 .  
 BY AMP INCORPORATED. ALL RIGHTS RESERVED.

LOC	DIST	REVISIONS					
DY	-	P	LTR	DESCRIPTION	DATE	DWN	APVD
		-		SEE SHT 1 OF 2	-	-	-

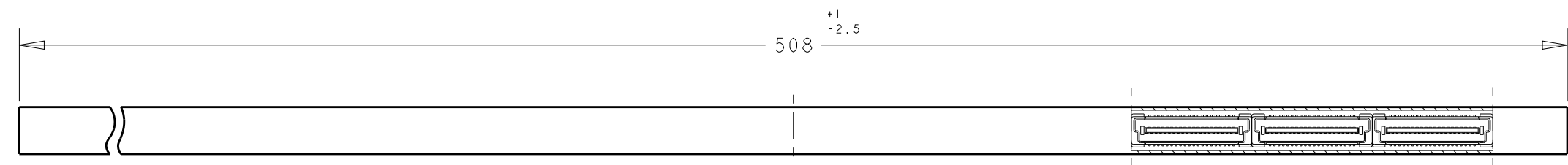

SECT A-A



SECT B-B

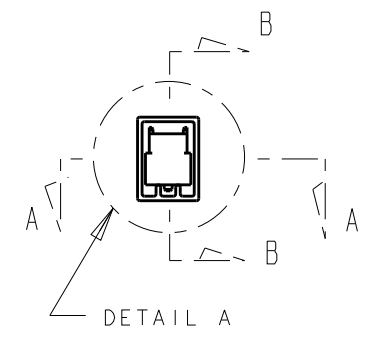

REFERENCE PICTURE OF TUBE PACK

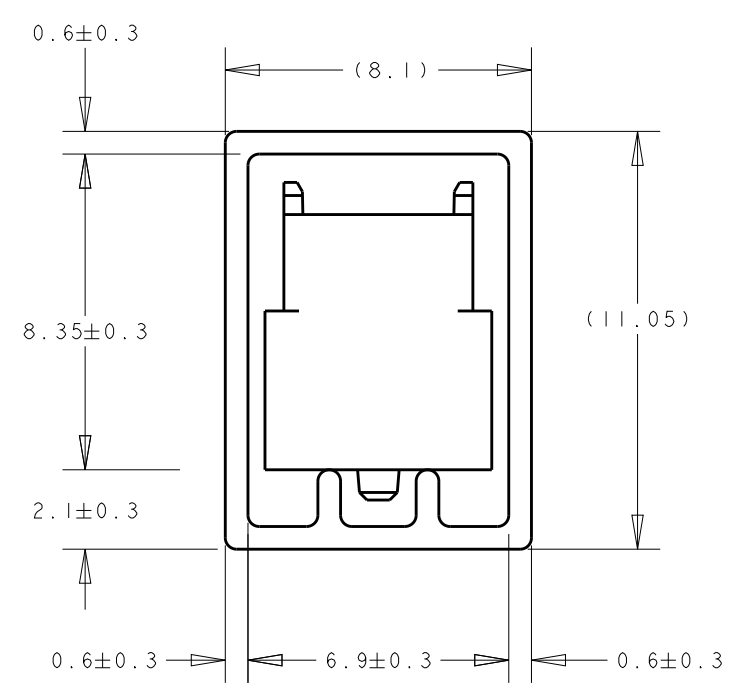

DETAIL "B"  
(SCALE 5-1)

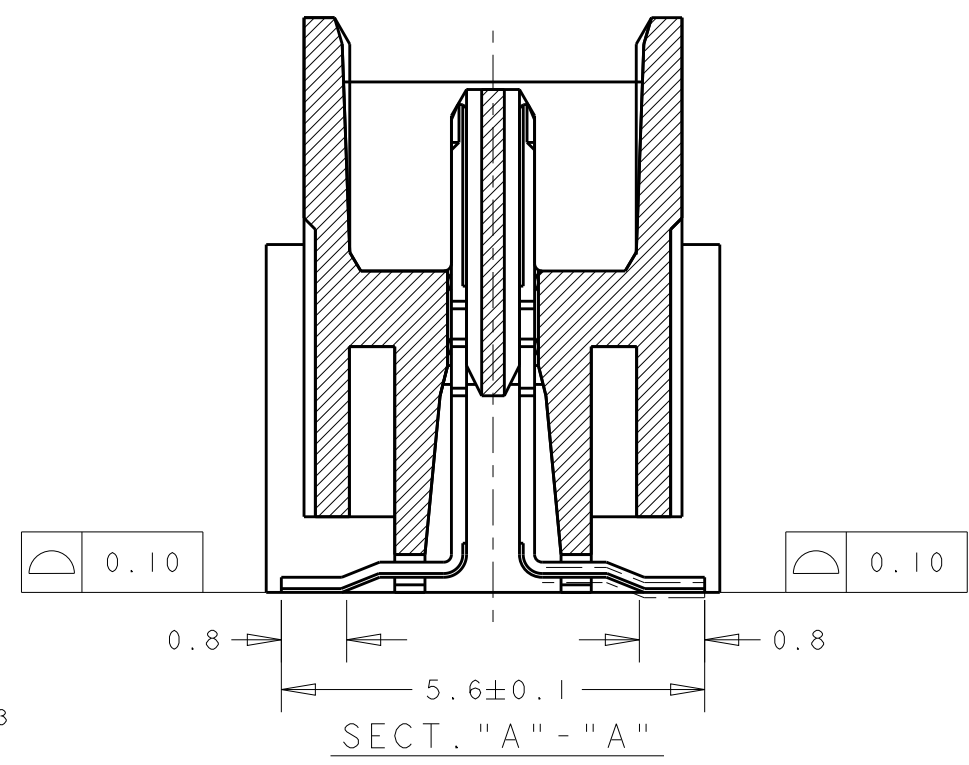

SECT. "A" - "A"

5	AVAILABLE	16	28.2	29.8	23.2	60	2-	-1
	NOT AVAILABLE	14	32.2	33.8	27.2	70	1-	-1
	AVAILABLE	5	84.2	85.8	79.2	200	1-	-0
		6	76.2	77.8	71.2	180		-9
		6	68.2	69.8	63.2	160		-8
		7	60.2	61.8	55.2	140		-6
		9	52.2	53.8	47.2	120		-5
		10	44.2	45.8	39.2	100		-4
		12	36.2	37.8	31.2	80		-3
		16	28.2	29.8	23.2	60		-2
22	20.2	21.8	15.2	40		6123002-1		
STATUS		QTY/TUBE	C	B	A	POS.	CONN P/N	

LOW HALOGEN

THIS DRAWING IS A CONTROLLED DOCUMENT FOR AMP INCORPORATED. IT IS SUBJECT TO CHANGE AND THE CONTROLLING ENGINEERING ORGANIZATION SHOULD BE CONTACTED FOR THE LATEST REVISION.

DWN: FLORENCE TAN 13SEP04  
 CHK: ERIC TNG  
 APVD: SEIFONG

AMP Tyco Electronics Singapore

NAME: PLUG ASSY FOR FH 0.8 BTB CONNECTOR 8H 0.5 BOSS LENGTH (0.76um GOLD)

PRODUCT SPEC: 108-5390  
 APPLICATION SPEC: 114-5254

SIZE: A3 CAGE CODE: 00779 DRAWING NO: 6123002

MATERIAL: 1 FINISH: 2

WEIGHT: -

CUSTOMER DRAWING SCALE: 4:1 SHEET: 2 OF 2 REV: B

单击下面可查看定价，库存，交付和生命周期等信息

[>>TE Connectivity\(泰科\)](#)