

4

3

2

1

THIS DRAWING IS UNPUBLISHED.

RELEASED FOR PUBLICATION

20

© COPYRIGHT 20 BY -

ALL RIGHTS RESERVED.

REVISIONS

P	LTR	DESCRIPTION	DATE	DWN	APVD
B1		ECR-16-018198	27DEC2016	QY	CW
C		ECR-21-111798	22SEP2021	WQR	CW
D		ECR-22-158463	05JAN2023	BS	CW
E		ECR-23-168984	21MAR2023	BS	CW

TYPE-1:T2111020201-000 TE LOGO
 类型-1:T2111020201-000 TE LOGO

NOTES:

1. TECHNICAL CHARACTERISTICS:
 INSULATION MATERIAL: PC
 RATED VOLTAGE: 1000V
 RATED CURRENT: 70A
 INSULATION RESISTANCE: $\geq 400M\Omega$
 RATED IMPULSE VOLTAGE: 8KV
 POLLUTION DEGREE: 3
 FLAMMABILITY: UL94V-0
 MATING CYCLES: 500 CYCLES
 WIRE RANGE: 10~25 mm²
 CONTACT TYPE: CRIMP CONTACT

2. CONTACT NEED TO BE ORDERED SEPARATELY.
 (ORDER No. REFER TO DRAWING:T2400002XX0000)

注释:

1. 技术参数:
 绝缘材料: PC
 额定电压: 1000V
 额定电流: 70A
 绝缘电阻: $\geq 400M\Omega$
 额定脉冲电压: 8KV
 污染等级: 3
 阻燃等级: UL94V-0
 插拔次数: 500次
 接线范围: 10~25 mm²
 接线类型: 冷压接

2. 端子需要单独订购。
 (订货号参考图面: T2400002XX0000)

THIS DRAWING IS A CONTROLLED DOCUMENT.

DIMENSIONS:	TOLERANCES UNLESS OTHERWISE SPECIFIED:
mm	
	0 PLC \pm
	1 PLC \pm
	2 PLC \pm
	3 PLC \pm
	4 PLC \pm
	ANGLES \pm
MATERIAL	FINISH
-	-
-	-

DWN	17APR2015
David Wang	
CHK	17APR2015
Chris Wang	
APVD	17APR2015
Xiang Xu	
PRODUCT SPEC	108-137059
APPLICATION SPEC	114-137059
WEIGHT	-
Customer Drawing	

NAME		RESTRICTED TO	
HMN-002-FC			
SIZE	CAGE CODE	DRAWING NO	
A3	00779	T2111020201000	
SCALE		SHEET	REV
3:2		1 OF 2	E

1470-19 (3/13)

Downloaded From Onevac.com

THIS DRAWING IS UNPUBLISHED.

RELEASED FOR PUBLICATION

20

© COPYRIGHT 20 BY -

ALL RIGHTS RESERVED.

REVISIONS

P	LTR	DESCRIPTION	DATE	DWN	APVD
-	-	SEE SHEET 1	-	-	-

NOTES:
SEE SHEET 1
注释:
见页 1

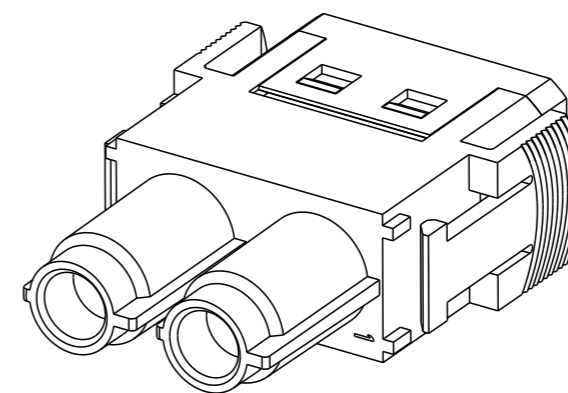
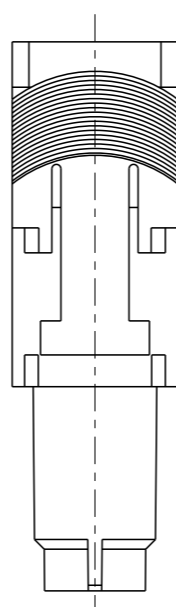
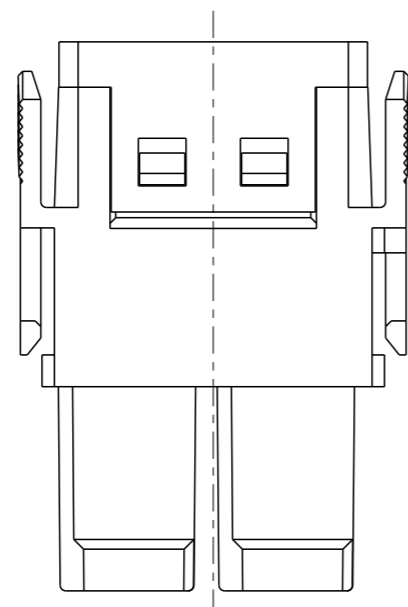
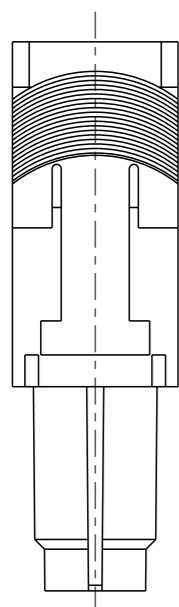
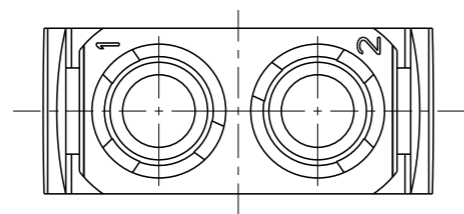

TYPE-2:T2111020201-001 NO LOGO
类型-2:T2111020201-001 NO LOGO

ALL DIMENSIONS ARE SAME AS TYPE 1,
EXCEPT THOSE DEFINED IN THIS TYPE.
除了在本类型中定义的尺寸外,其它尺寸同类型 1

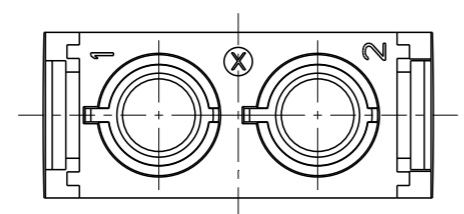

T2111020201-001	HMN-002-FC	HMN-002 FEMALE MODULE INSERT, CRIMPING, NO LOGO HMN-002冷压型模块母插, 无LOGO	TYPE-2 类型-2
T2111020201-000	HMN-002-FC	HMN-002 FEMALE MODULE INSERT, CRIMPING HMN-002冷压型模块母插	TYPE-1 类型-1
PART NUMBER 料号	PART DESCRIPTION 描述		TYPE 类型

THIS DRAWING IS A CONTROLLED DOCUMENT.

DIMENSIONS:
mm

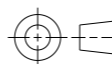

TOLERANCES UNLESS OTHERWISE SPECIFIED:

0 PLC ±-
1 PLC ±-
2 PLC ±-
3 PLC ±-
4 PLC ±-
ANGLES ±-

MATERIAL

FINISH

DWN 17APR2015

David Wang

CHK 17APR2015

Chris Wang

APVD 17APR2015

Xiang Xu

PRODUCT SPEC

108-137059

APPLICATION SPEC

114-137059

WEIGHT

-

NAME

HMN-002-FC

SIZE

CAGE CODE

DRAWING NO

A300779

©-T2111020201000

RESTRICTED TO

-

Customer Drawing

SCALE 3:2

SHEET 2 OF 2

REV E

单击下面可查看定价，库存，交付和生命周期等信息

[>>TE Connectivity\(泰科\)](#)