

THIS DRAWING IS UNPUBLISHED. RELEASED FOR PUBLICATION 2000
 © COPYRIGHT 2000 BY TYCO ELECTRONICS CORPORATION. ALL RIGHTS RESERVED.

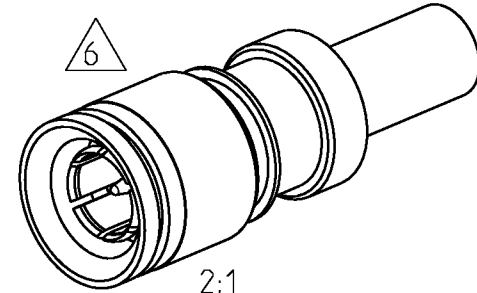

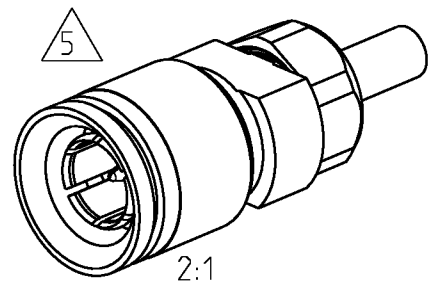

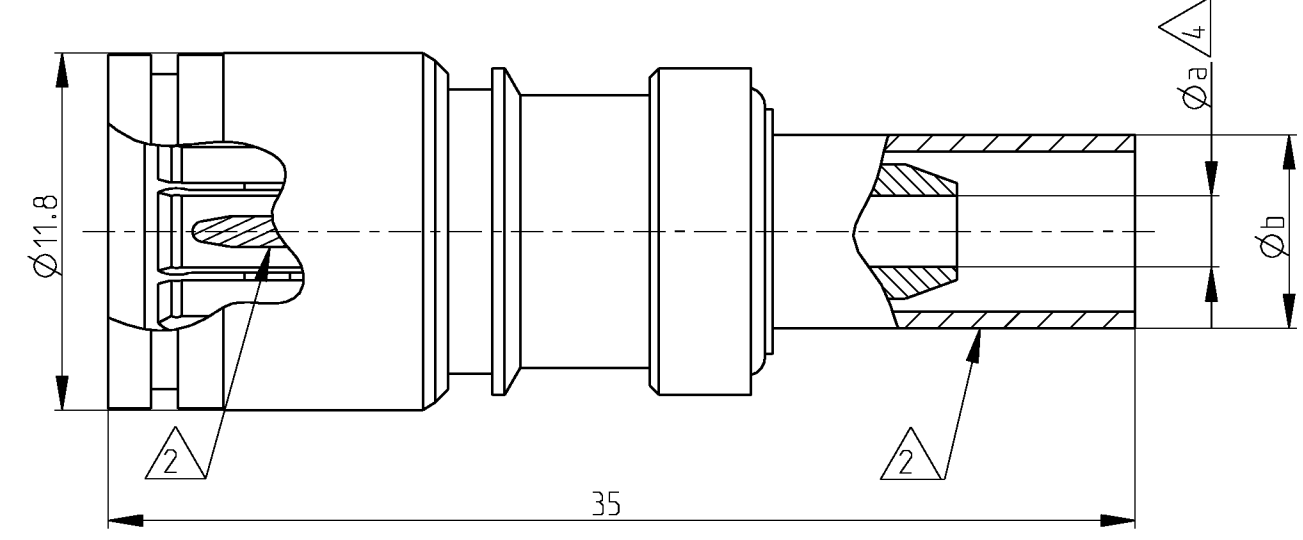

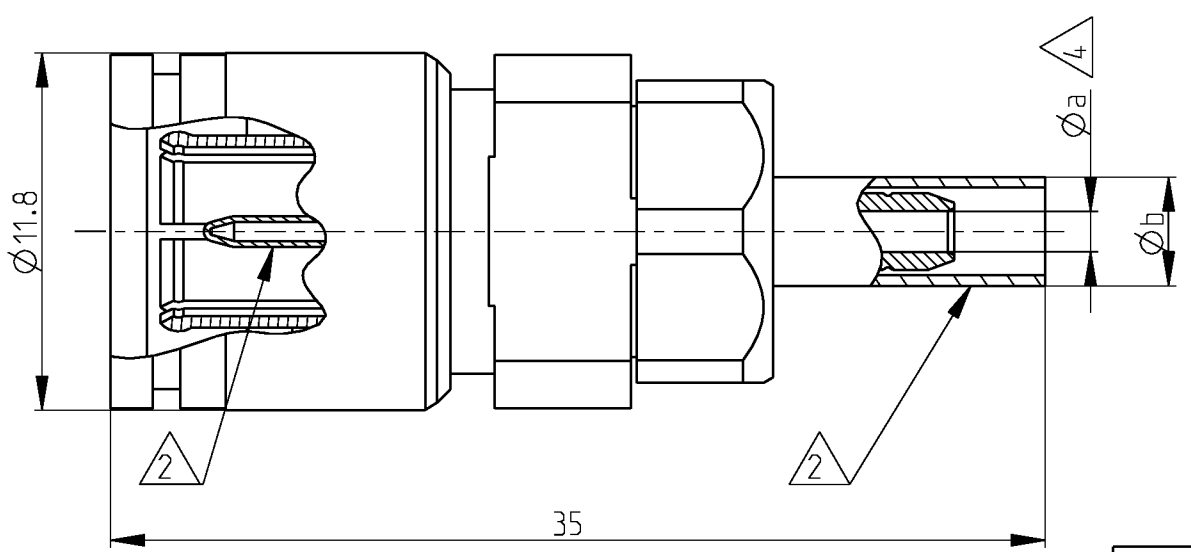





LOC	DIST	REVISIONS			
P	LTR	DESCRIPTION	DATE	DWN	APVD
GW	-	A	-	5APR2001	BL KM
		A1	PN added + Applic. spec. in table + pack. info	27JUN2003	FH RL
		B	overall connector length corrected	17JUN2004	FH RL
		B1	REV PER ECO-09-026495	30NOV09	KK AEG









Connector layout 

Connector layout 



Cross reference table

Old PN	Tyco PN	Application spec.	Description	Material	Plating	Cable type	Øa	Øb
-	1460043-4	114-71021	Outer cond.	CuBe	1µm Au min in contact area	02Y (St) CY 0.45/2.0	2.15	5.2
	  		Center cond.	CuSn6	1µm Au min in contact area			
			Dielectric	PEEK	-			
V23612-B102-P76	1393672-9	114-71021	Outer cond.	CuBe	1µm Au min in contact area	02Y (St) CY 0.45/2.0	2.15	5.2
	 		Center cond.	CuSn6	1µm Au min in contact area			
			Dielectric	PEEK	-			
V23612-A102-P76	1393672-3	114-71019	Outer cond.	CuBe	1µm Au min in contact area	02Y (St) CY 0.45/2.0	2.15	5.2
	 		Center cond.	CuSn6	1µm Au min in contact area			
			Dielectric	PEEK	-			
 OBSOLETE	1393672-2	114-71019	Outer cond.	CuBe	1µm Au min in contact area	02Y 12YC (mS) (6Y 0.45/2.0	2.15	5.2
	 		Center cond.	CuSn6	1µm Au min in contact area			
			Dielectric	PEEK	-			
OBSOLETE	1460132-4	114-71019	Outer cond.	CuBe	1µm Au min in contact area	02YS (St) CHH 0.25/1.2 HF 75 0.25/1.15	1.3	3.8
	 		Center cond.	CuSn6	1µm Au min in contact area			
			Dielectric	PEEK	-			

-  **OBSOLETE PARTS: OBSOLETE CIS STREAMLINING PER D.RENAUD/D.SINISI**
-  Bulk packaging.
-  Tray packaging.
-  Individual packaging.
-  Pre-assembled version.
-  Version with loose parts.
-  Minimum dimension.
- 3) Mating face according to DIN 47295/CECC 22240.
-  Supplied as loose part.

1) All dimensions are maximum dimensions unless otherwise specified.

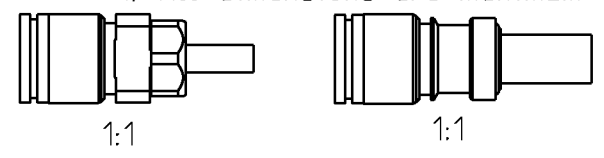

THIS DRAWING IS A CONTROLLED DOCUMENT FOR TYCO ELECTRONICS CORPORATION IT IS SUBJECT TO CHANGE AND THE CONTROLLING ENGINEERING ORGANIZATION SHOULD BE CONTACTED FOR THE LATEST REVISION.

DWN	23FEB2001	 Tyco Electronics Oostkamp - Belgium			
CHK	5APR2001				
APVD	5APR2001				
PRODUCT SPEC					
NAME	Straight cable plug 1.6/5.6 (75 ohm)				
APPLICATION SPEC	see table	SIZE	CAGE CODE	DRAWING NO	RESTRICTED TO
WEIGHT	-	A3	00779	1393672-3	-
CUSTOMER DRAWING	SCALE	4/1	SHEET	1 OF 1	REV
					B1

单击下面可查看定价，库存，交付和生命周期等信息

[>>TE Connectivity\(泰科\)](#)