

4

3

2

1

THIS DRAWING IS UNPUBLISHED.

RELEASED FOR PUBLICATION

20

© COPYRIGHT 20 BY -

ALL RIGHTS RESERVED.

REVISIONS

P	LTR	DESCRIPTION	DATE	DWN	APVD
B		ECR-15-013292	24SEP2015	DL	CW
B1		ECR-15-017530	02DEC2015	GY	CW
B2		ECR-16-015492	08NOV2016	QY	CW
C		ECR-21-105750	30JUN2021	BS	CW

NOTES:

- TECHNICAL CHARACTERISTICS:
INSULATION MATERIAL: PC
RATED VOLTAGE: 250 V
RATED CURRENT: 10 A
INSULATION RESISTANCE: $\geq 400M\Omega$
RATED IMPULSE VOLTAGE: 4 KV
POLLUTION DEGREE: 3
FLAMMABILITY: UL94V-0
MATING CYCLES: 500 CYCLES
WIRE RANGE: 0.14-2.5 mm² (26-14 AWG)
CONTACT TYPE: CRIMP CONTACT
- CONTACT NEED TO BE ORDERED SEPARATELY.
(ORDER No. REFER TO DRAWING: T20200X20XX000)

注释:

- 技术参数:
绝缘材料: PC
额定电压: 250V
额定电流: 10A
绝缘电阻: $\geq 400M\Omega$
额定脉冲电压: 4 KV
污染等级: 3
阻燃等级: UL94V-0
插拔次数: 500次
接线范围: 0.14-2.5 mm² (26-14 AWG)
接线类型: 冷压接
- 端子需要单独订购。
(订货号参考图面: T20200X20XX000)

4X M3 SCREW RECOMMENDED
TIGHTENING TORQUE 0.5Nm
4X M3螺丝, 推荐锁紧力矩0.5Nm

M4 SCREW RECOMMENDED
TIGHTENING TORQUE 1.2Nm
M4 螺丝, 推荐锁紧力矩1.2Nm

PANEL CUT OUT FOR INSERTS FOR USE
WITHOUT HOODS/HOUSINGS
不用防护外壳时芯件的安装开孔图

TYPE-1, T2020402201-000, TE LOGO
类型-1, T2020402201-000, TE LOGO

TYPE-2, T2020402201-001, STAINLESS STEEL SCREW, TE LOGO
类型-2, T2020402201-001, 不锈钢螺丝, TE LOGO

THIS DRAWING IS A CONTROLLED DOCUMENT.		DWN 16DEC2014 RAGHAVENDRA H M	 TE Connectivity	
DIMENSIONS: mm		CHK 16DEC2014 CHRIS WANG		
TOLERANCES UNLESS OTHERWISE SPECIFIED:		APVD 16DEC2014 XU XIANG	PRODUCT SPEC 108-137042	RESTRICTED TO
0 PLC ±- 1 PLC ±- 2 PLC ±- 3 PLC ±- 4 PLC ±- ANGLES ±-		APPLICATION SPEC -	SIZE A3	CAGE CODE -
MATERIAL -		FINISH -	WEIGHT -	DRAWING NO T2020402201000
-		Customer Drawing		SCALE 1:1 SHEET 1 OF 2 REV C

1470-19 (3/13)

Downloaded From Oneyac.com

THIS DRAWING IS UNPUBLISHED.

RELEASED FOR PUBLICATION

20

© COPYRIGHT 20 BY -

ALL RIGHTS RESERVED.

REVISIONS

P	LTR	DESCRIPTION	DATE	DWN	APVD
-		SEE SHEET 1	-	-	-

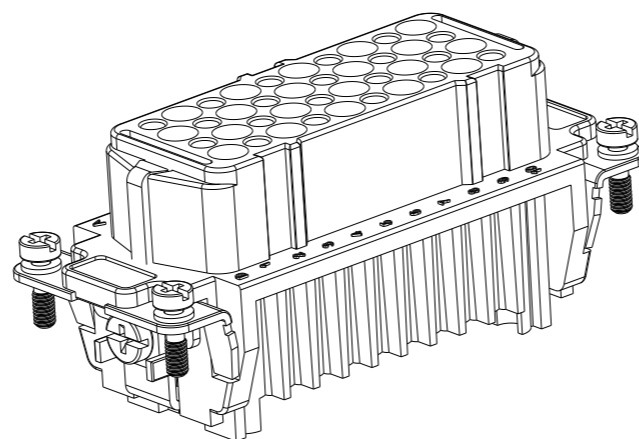
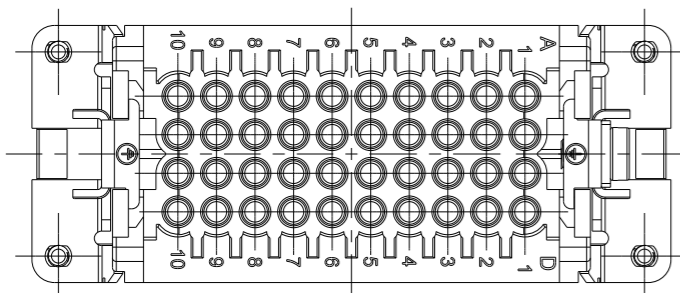

NOTE:
SEE SHEET 1

注释:
见页 1

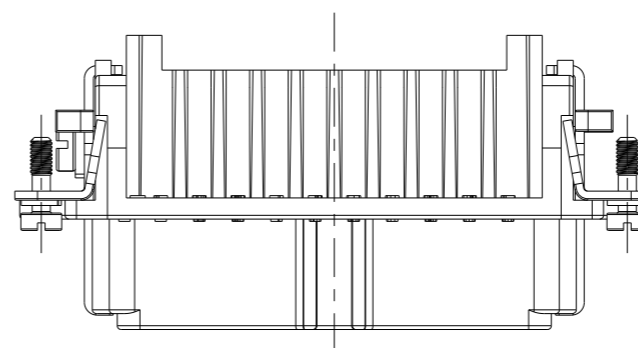
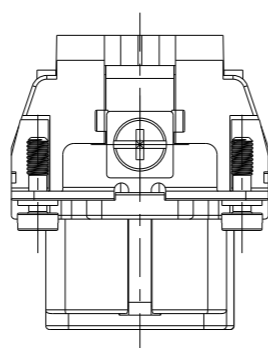
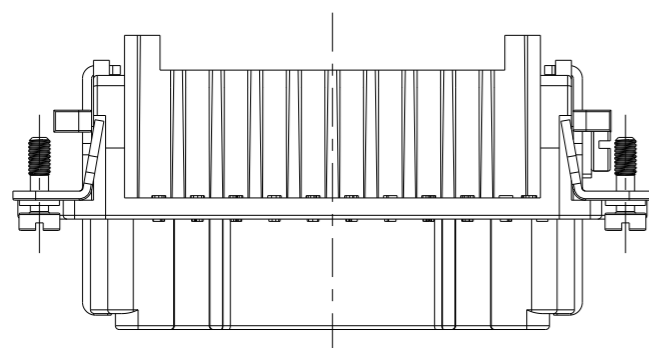

TYPE-3, T2020402201-002, STAINLESS STEEL SCREW, NO LOGO
类型-3, T2020402201-002, 不锈钢螺丝, 无LOGO

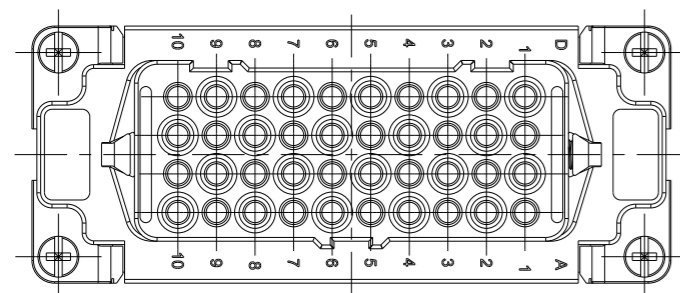

ALL DIMENSIONS ARE SAME AS TYPE 1,
EXCEPT THOSE DEFINED IN THIS TYPE.
除了在本类型中定义的尺寸外, 其它尺寸同类型 1

T2020402201-002	HD-040-F	HD-040 FEMALE INSERT, STAINLESS STEEL SCREW, NO LOGO HD-040 母插, 不锈钢螺丝, 无LOGO	TYPE-3 类型-3
T2020402201-001	HD-040-F	HD-040 FEMALE INSERT, STAINLESS STEEL SCREW HD-040 母插, 不锈钢螺丝	TYPE-2 类型-2
T2020402201-000	HD-040-F	HD-040 FEMALE INSERT HD-040 母插	TYPE-1 类型-1
PART NUMBER 料号	PART DESCRIPTION 描述		TYPE 类型

THIS DRAWING IS A CONTROLLED DOCUMENT.		DWN 16DEC2014 RAGHAVENDRA H M	 TE Connectivity	
DIMENSIONS: mm		CHK 16DEC2014 CHRIS WANG		
TOLERANCES UNLESS OTHERWISE SPECIFIED:		APVD 16DEC2014 XU XIANG	NAME HD-040-F	
0 PLC ±- 1 PLC ±- 2 PLC ±- 3 PLC ±- 4 PLC ±- ANGLES ±-		PRODUCT SPEC 108-137042	SIZE A3	CAGE CODE -
MATERIAL -		FINISH -	APPLICATION SPEC -	DRAWING NO T2020402201000
		WEIGHT -	RESTRICTED TO -	SCALE 1:1
		Customer Drawing	SHEET 2 OF 2	REV C

单击下面可查看定价，库存，交付和生命周期等信息

[>>TE Connectivity\(泰科\)](#)