

Table of Contents

ARINC 600 Connectors

Introduction 3002

Ordering Information 3003

Shell Size 1 3004

Shell Size 2 3005

Shell Size 3 3006, 3007

Contact Inserts and Arrangement Codes 3008-3010

Inserts for Expanded Beam Fiber Optics 3011

Keying 3012, 3013

Contact Style/Shell Modification Codes 3014, 3015

Crimp, Snap-In Contacts 3016

Posted Contacts 3017, 3018

COAXICON Contacts 3019-3022

ARINC Size 8 Quadrax Contacts 3023

ARINC Size 8 Quadrax Solder Contacts 3024

Traffic Alert and Collision Avoidance System (TCAS) Connectors and
Mode S Transponder Connectors 3025, 3026

Single Mod ARINC 600 3027-3029

EMI/Ground Spring 3030

Recommended Panel Cutouts 3031, 3032

Accessories 3032

Application Tooling & Insertion/Extraction Tooling 3033

Cross Reference 3034-3036

ARINC 404 Connectors

Introduction 3037

Ordering Information 3038

One- and Two-Insert Shells 3039

Three- and Four-Insert Shells 3040

Contact Inserts 3041

Modification 3042, 3043

Keying (table on page 3012 & 3013) 3044

Custom Order Codes 3044

Size 22 Contacts Pin Diameter .030 [0.76] 3045

Size 20 Contacts Pin Diameter .040 [1.02] 3045

Size 16 Contacts Pin Diameter .062 [1.58] 3046

Size 12 Contacts Pin Diameter .096 [2.39] 3046

Application Tooling & Insertion/Extraction Tooling 3047

COAXICON Contacts 3048-3050

Plugs, Boots and Contacts 3051

106-Contact Inserts for Flexible Flat Cable 3051

Flexible Flat Cable Applications 3052

Special Shell and Inserts 3053

Cross Reference 3054, 3055

ARINC Connectors Military Cross Reference 3056-3062

Hexashield High Performance EMC Adapters 3063-3068

Introduction

Product Facts

- Designed to meet relevant ARINC 600 Connector specifications
- Available in three sizes
- Low mating-force contacts — suitable for ARINC 404 Connectors
- Full range of contact inserts

Specifications

Temperature Range —

-85°F to 257°F [-65°C to 125°C]

Mating and Unmating Forces —

(Max. after 3 cycles)

Size 1 — 27 pounds [120 N]

Size 2 — 60 pounds [267 N]

Size 3 — 105 pounds [467 N]

Contact Retention against axial load —

Size 22 — 12 pounds [53 N]

Size 20 — 20 pounds [89 N]

Size 16 — 25 pounds [111 N]

Size 12 — 30 pounds [133 N]

Coaxial — 35 pounds [156 N]

(In testing, exposure to rated loads produced no contact damage and resulted in displacement less than .015 [0.38])

Voltage/Current Ratings —

Contact	AWG	Max. Current (A)
Size 22	22	5.0
Size 20	20	7.5
Size 16	16	13.0
Size 12	12	23.0

Durability — 500 cycles min. — mating and unmating (In testing, wired mated connectors cycled at a rate slower than 300 cycles per hour, showed no apparent damage or contact resistance greater than rated values)

High Temperature Tolerance — 1000 hours min. at 257°F [125°C] (Wired, mated connectors)

Salt Spray Tolerance — As specified by MIL-STD-1344, method 1001, Condition B

Fluid Imperviousness — MIL-L-23699; MIL-H-5606: 1:3 mix isopropyl alcohol and mineral spirits (Test immersions of mated connectors in these fluids caused no evident deterioration)

Vibration and Shock Tolerance — Per MIL-STD-1344, methods 2004-1 and 2005-1 (Testing to these conditions, including vibration for 8 hours in each of 3 mutually perpendicular axes, caused no visible cracking, breaking or loosening of parts, and no discontinuities exceeding 1 microsecond)

Humidity Tolerance — Insulation resistance 1 megohm min., 1-2 hours after exposure to humidity per MIL-STD-1344, Method 1002-1, Type II; 5000 megohm min. after 24 hours at 77°F [25°C].

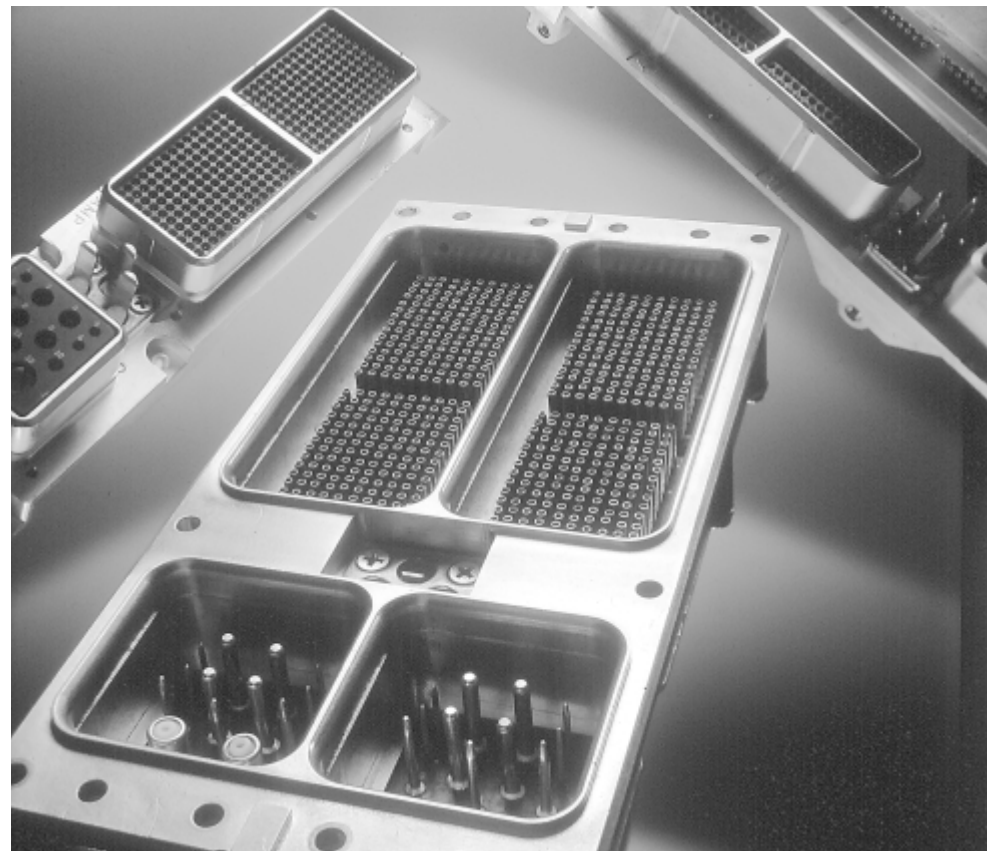

Dielectric Withstanding Voltage — (Min.) 1500 VAC, RMS 60 Hz at sea level; 500 VAC, RMS 60 Hz at 50,000 ft. [15240 M] (Testing at rated voltages for 60 seconds produced no flash over and 1 mA leakage, max.)

Insulation Resistance — 1000 megohms min. (Test conducted on unmated connector after 30 min. exposure to 248°F–257°F [120°C–125°C])

Contact Resistance — Mated pairs tested per MIL-STD-1344, Method 3004-1

Technical Document — ARINC 600 Product Specification 108-10050

ARINC 600 Connectors are used in virtually all airframes and today's state-of-the-art avionics equipment. From collision avoidance (TCAS, TAWS) to in-flight entertainment/networking, new avionics equipment demands higher data transmission rates. Whether it's Fibre Channel, or 100-Base-T or 100-Base-FX Ethernet and beyond, Tyco Electronics has the insert configurations and copper and fiber hardware (Quadrax contacts, RF,

and Mini-Expanded Beam Fiber Optics) to meet the need. Standard industry configurations are available. For designs that require custom configurations, Tyco Electronics will work with you to provide the connector solution required.

ARINC 600 Connectors represent a new generation of standardized rack and panel connectors for aircraft applications. Compared to the preceding ARINC 404 standard, the new avionics connectors feature significantly reduced mating forces; increased numbers of contacts in housings proportioned to thinner black-box shapes; and floating, front-release keying. ARINC 600 Connectors capitalize on the new design by adding unique features while maintaining interchangeability. For instance, AMP contact inserts are field replaceable and manufactured to precise tolerances.

AMP contacts for ARINC 600 Connectors are applied with standard crimping tools—the same ones used for ARINC 404 contacts. Automatic crimping equipment is available for higher productivity and lower applied costs. The benefits of ARINC 600 reduced engagement force contacts (for example: size 22 contacts averaging 1.5 ounces [0.42 N]) can be realized in ARINC 404 connectors through the use of the interchangeable ARINC 600 contacts. ARINC 600 coaxial contacts also are crimp applied for reliable, solder-free installation.

It is easy to specify ARINC 600 Connectors by descriptive part numbers. An example of a descriptive part number is shown on page 3003, with an explanation of each component of the part number and page references for complete information.

Ordering Information

Descriptive Part Numbering System

Use this guide to construct descriptive part numbers for ARINC 600 Connectors. Consult the referenced pages for additional information.

Materials

Shell — Die cast aluminum or machined aluminum per ASTM-B-85

Insert Retention Plates — Aluminum alloy

Finish — Chemical conversion coating per MIL-C-5541, Class 1A or electroless nickel per MIL-C-26074, Class 3 or 4, Grade B

Screws and Lockwashers — Steel with chromate over zinc or stainless steel

Polarizing Keyways — Zinc alloy

Polarizing Posts — Aluminum alloy or stainless steel

Insulators — Thermoset or Thermoplastic

Sample Descriptive Part Number

NIC66 E 11 A 01 AA 1

Series Designation — All ARINC 600 Connectors (For "Single Mod" ARINC Connectors, see page 3027.)

Shell Size/Plating — (See pages 3004 through 3007)

Shells With Chromate Conversion Coating

- E—Size 1 Receptacle
- F—Size 1 Plug
- G—Size 2 Receptacle
- H—Size 2 Plug
- J—Size 3 Receptacle
- K—Size 3 Plug

Shells With Electroless Nickel Plating

- EN—Size 1 Receptacle
- FN—Size 1 Plug
- GN—Size 2 Receptacle
- HN—Size 2 Plug
- JN—Size 3 Receptacle
- KN—Size 3 Plug

Contact Inserts & Arrangement Codes — (See pages 3008 through 3010) Describes size, number of contacts, style of contacts and arrangement of inserts. Insert styles are further defined by both **Class** and **Contact Style/Shell Modifications** below. Insert arrangement codes are not defined for connectors using either Quadrax or Expanded Beam Fiber Optic inserts. Contact Tyco Electronics for specific part numbers.

- Class** —
- A—Nonenvironmental, rear release (unsealed inserts)
 - B—Environmental, rear release (sealed inserts)
 - C—Environmental, rear release without O-ring or sealant around inserts (sealed inserts)
 - F—Class C with cantilever style EMI/grounding spring (plug connectors only)
 - G—Class A with cantilever style EMI/grounding spring (plug connectors only)
 - H—Class C with canted coil style EMI/grounding spring (plug connectors only)
 - J—Class A with canted coil style EMI/grounding spring (plug connectors only)
 - FA—Nonenvironmental, front release/remove size 22 contacts (other contact sizes rear release/remove)
 - FF—Nonenvironmental, all contact sizes front release/remove except size 1 COAX remains rear removal

Keying — (See pages 3012 and 3013) Describes arrangement of keys

Contact Style/Shell Modifications — (See pages 3014 and 3015) Describes connector mounting configuration and contact style. The insert style is further modified by the contact style specified. Even when the connectors are ordered unloaded, the appropriate code must be used so that contacts fit properly.

Contact Loading —

- 0—Contacts included with connector, as indicated in contact style code above (no digit in this space also indicates connector includes contacts). COAXICON contacts must always be ordered separately.
- 1—Contacts not included with connector; must be ordered separately by AMP Part Number.

Shell Size 1

Receptacle

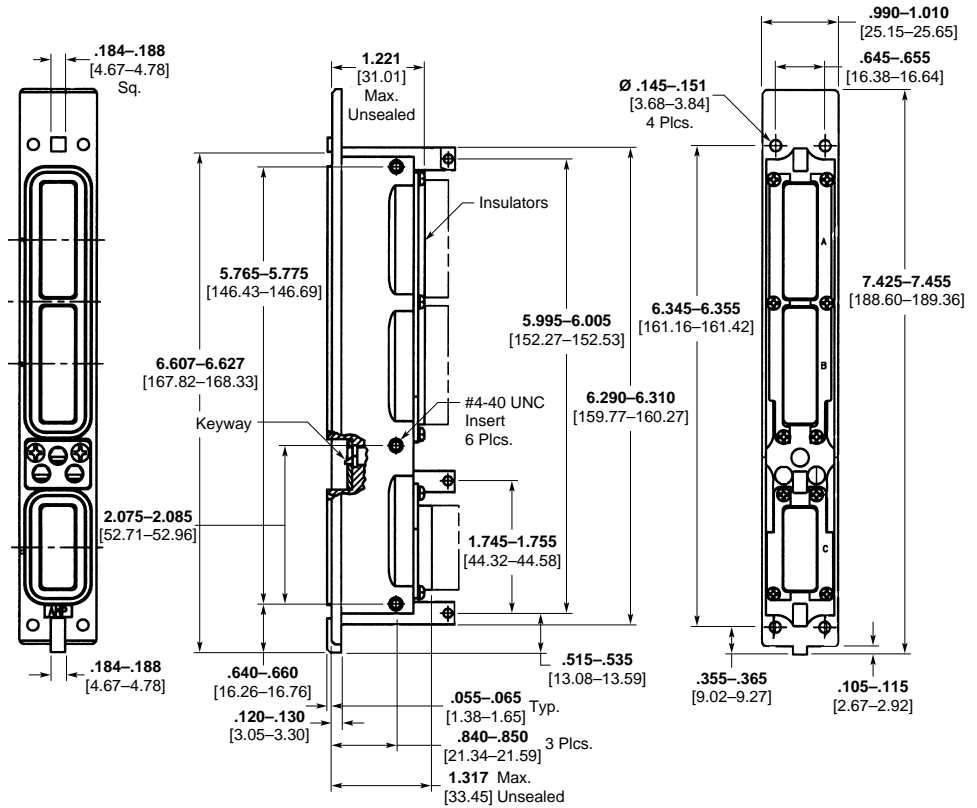

Plug

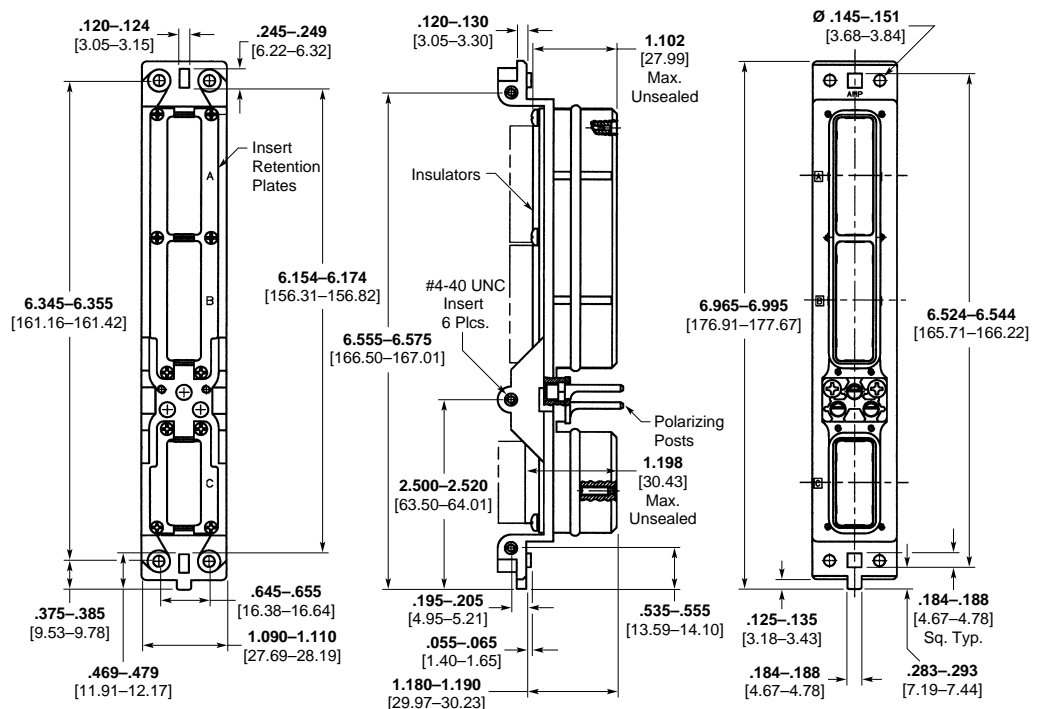

Shell Size 2

Receptacle

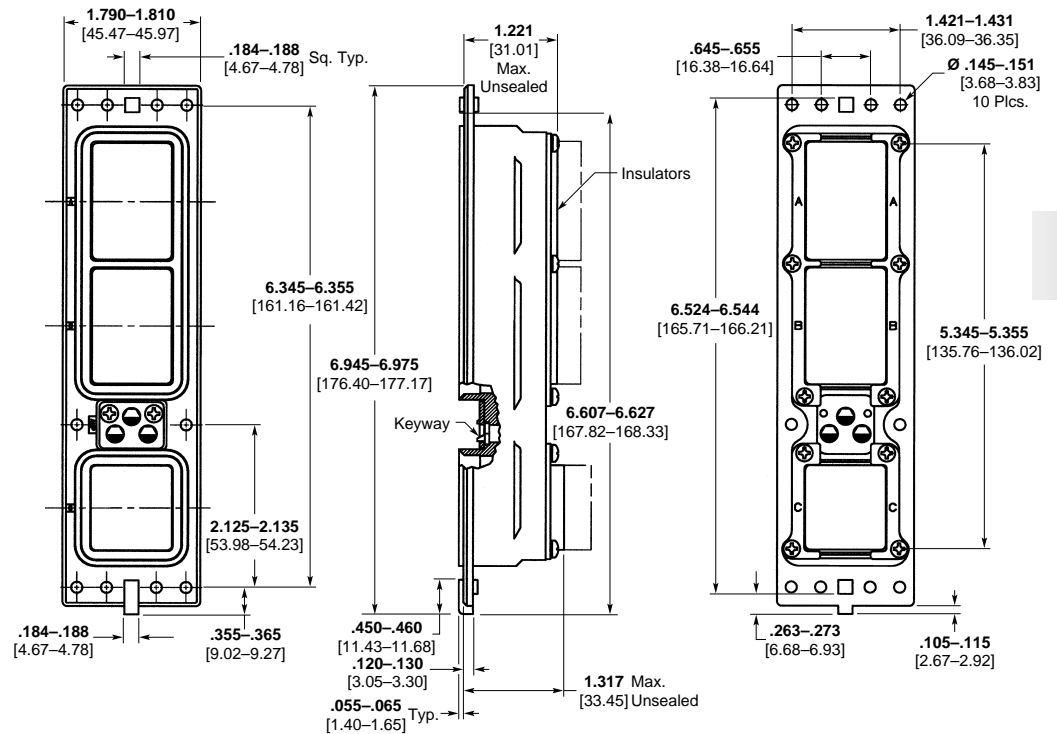

Plug

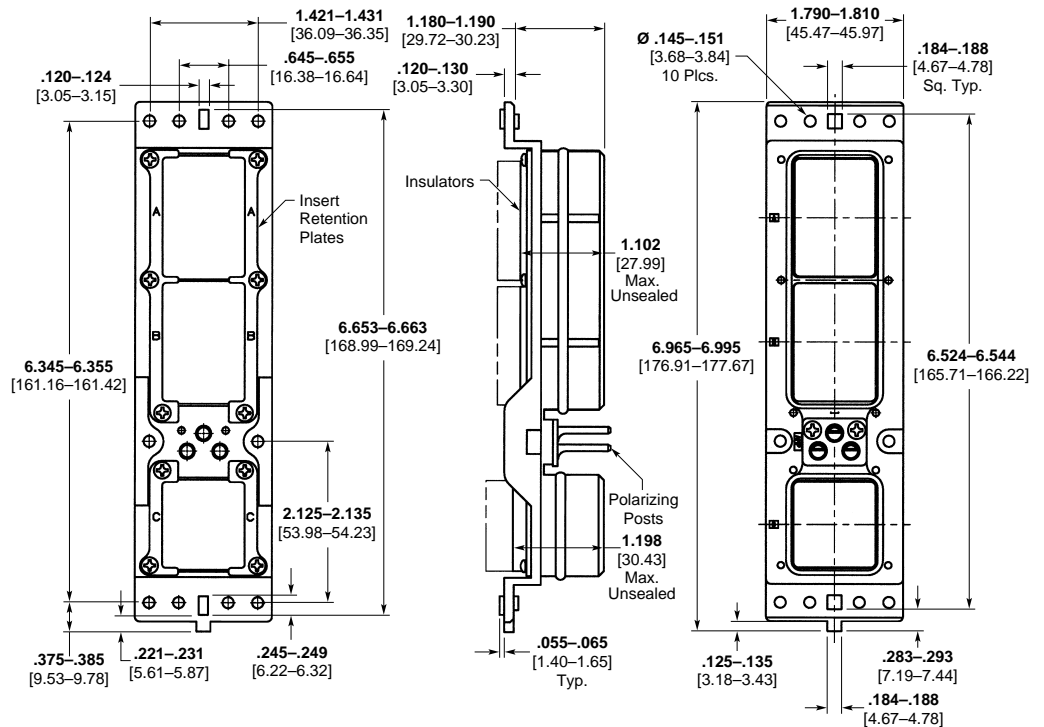

Receptacle

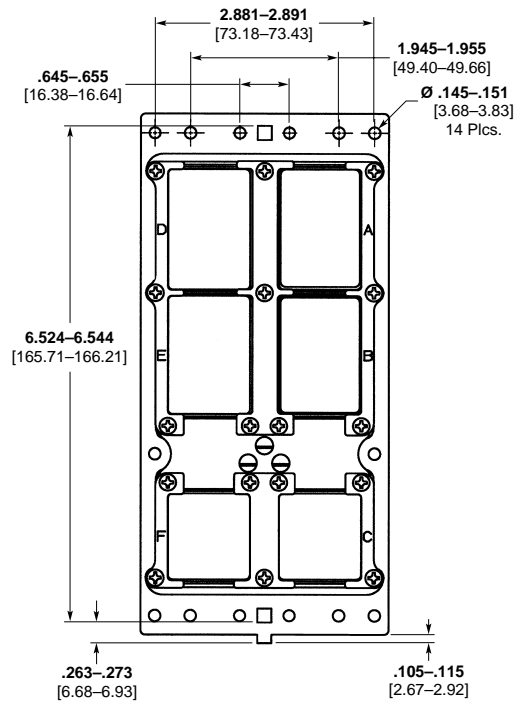
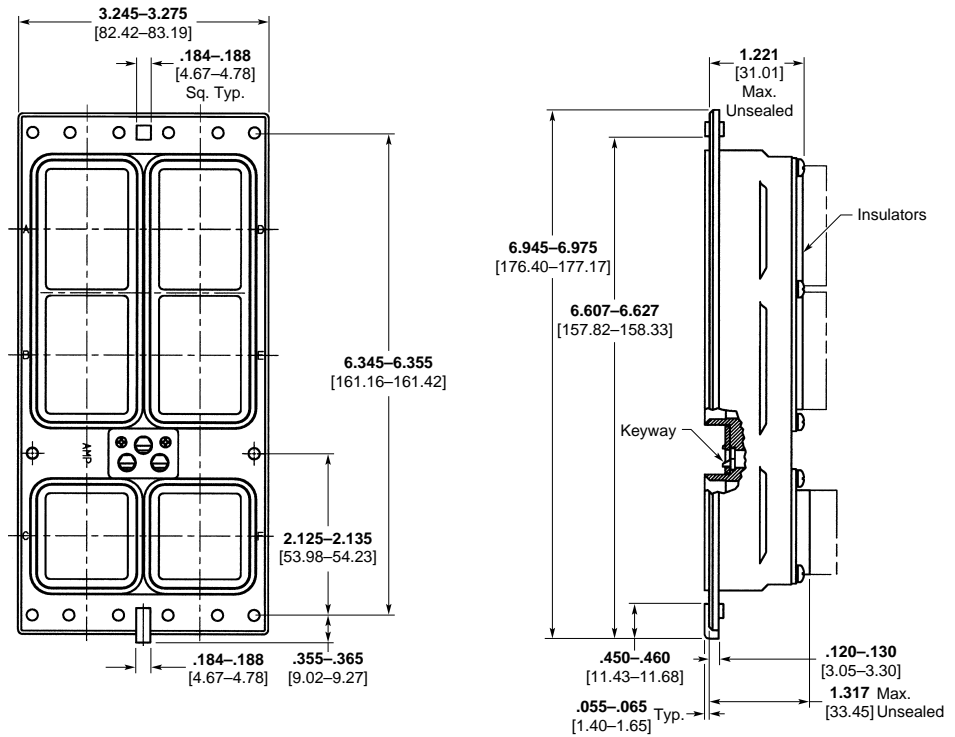

Shell Size 3 (Continued)

Plug

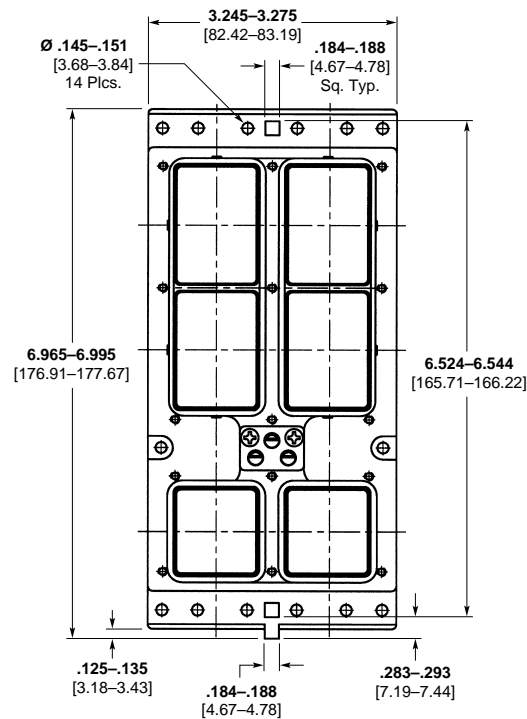
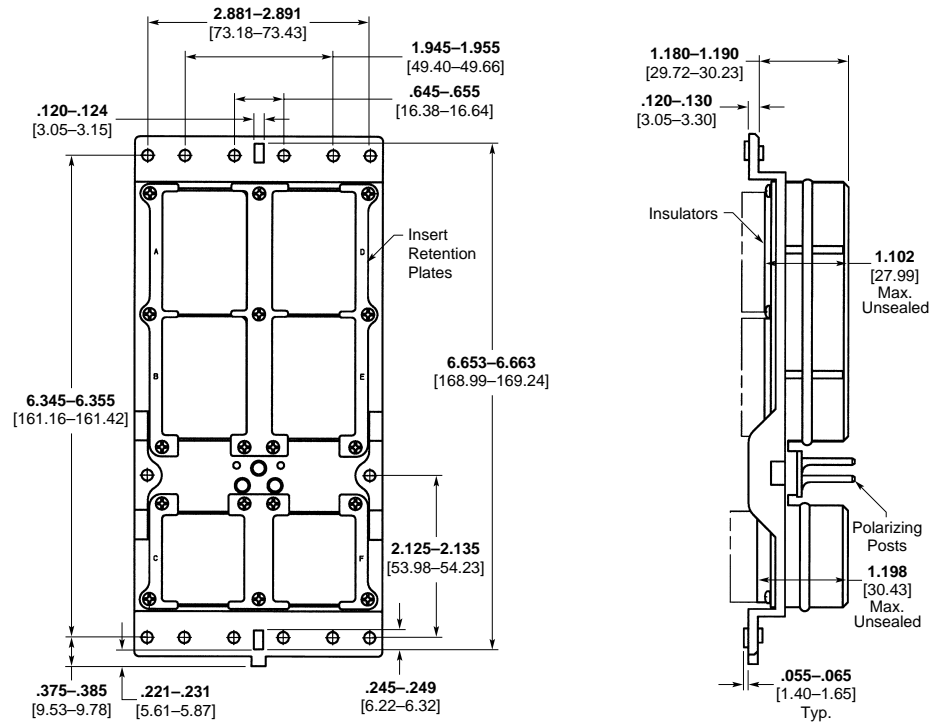

Contact Inserts and Arrangement Codes

Shell Size 1

Note: For Expanded Beam Fiber Optic Inserts, see page 3011.

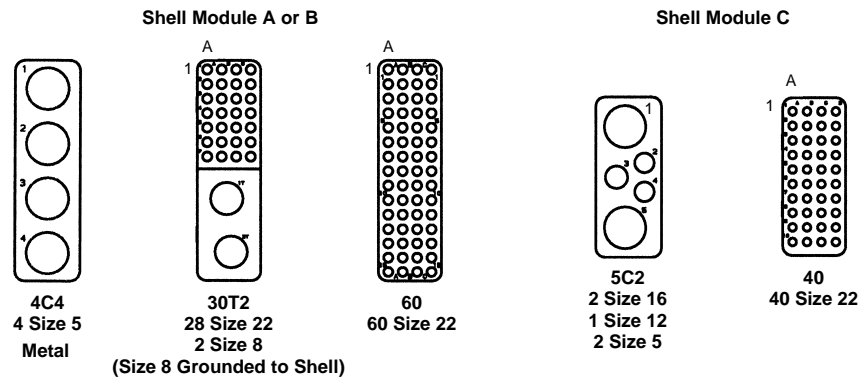

Shell Size 1 Plug
Rear Release/Remove Contacts

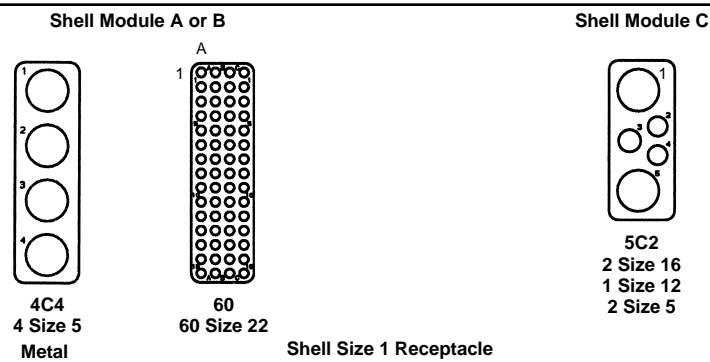

Shell Size 1 Receptacle
Rear Release/Remove Contacts

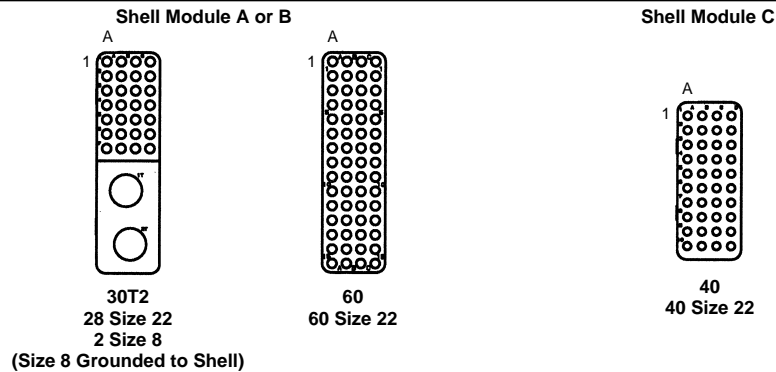

Shell Size 1 Receptacle Only
Front Release/Remove Size 22 Contacts (Other Size Contacts are Rear Release/Remove)

Shell Size	Arrangement Code	Module A	Module B	Module C
1	11	60	60	5C2
1	12	60	BLANK	BLANK
1	13	BLANK	60	BLANK
1	14	BLANK	60	5C2
1	15	60	60	40
1	16	OPEN	60	5C2
1	71	30T2	30T2	40
1	102	60	60	OPEN
1	104	60	OPEN	5C2
1	105	OPEN	OPEN	5C2
1	106	60	4C4	40
1	107	30T2	30T2	40
1	110	60	60	4
1	111	OPEN	30T2	40
1	112	60	4C4	5C2
1	113	60	OPEN	OPEN

Arrangement codes not shown are available upon request. Contact Tyco Electronics.

Shell Size 2 or 3 (Continued)

Shell Size	Arrangement Code	Module A	Module B	Module C
2	20	71C1A	71C1	13C2
2	21	150	150	13C2
2	22	71C1	150	13C2
2	23	71C1	71C1	13C2
2	25	150	71C1	13C2
2	26	150	150	100
2	27	C2	71C1	13C2
2	28	C2	71C1A	85
2	29	150	150	BLANK
2	30	71C1A	71C1A	13C2
2	50	71C1	71C1A	13C2
2	51	BLANK	150	13C2
2	52	150	150	85
2	53	C4	150	13C2
2	54	150	73C3	13C2
2	55	150	BLANK	13C2
2	56	150	C2	13C2
2	57	24	150	13C2
2	58	24	24	6T6
2	59	C4	C4	13C2
2	72	120T2	120T2	100
2	74	121	121	6T6
2	75	121	10T10	6T6
2	80	120T2	150	100
2	81	120T2	120T2	6T6
2	82	71C1A	150	13C2
2	83	150	C4	34

Shell Size	Arrangement Code	Module A	Module B	Module C
2	84	C4	C4	34
2	85	150	150	34
2	86	150	121	100
2	207	71C1	150	100
2	208	150	71C1	100
2	209	71C1	71C1	100
2	212	71C1	71C1	OPEN
2	216	C2A	71C1A	85
2	220	71C1	C2A	85
2	234	60	60	13C2
2	237	150	120T2	100
2	240	120T2	10T10	13C2
2	241	150	150	6T6
2	242	150	10T10	13C2
2	245	71C1	71C1	85
2	253	C2A	150	13C2
2	254	C2A	71C1A	100
2	255	C2A	71C1A	13C2
2	256	C2A	71C1	13C2
2	257	C2A	C2A	13C2
2	259	C4	C4	85
2	262	150	60	34
2	266	121	121	85
2	268	60	121	59
2	269	10T10	150	13C2
2	270	150	150	59
2	271	C4	120T2	13C2
2	272	10T10	10T10	85
2	273	121	60	6T6

Shell Size	Arrangement Code	Module A	Module B	Module C	Module D	Module E	Module F
3	31	150	150	13C2	150	150	13C2
3	32	150	150	100	150	150	13C2
3	33	150	150	13C2	150	150	100
3	34	150	150	100	150	150	100
3	36	C4	C4	13C2	BLANK	150	100
3	37	150	150	85	150	150	85
3	76	120T2	150	34	120T2	150	34
3	77	121	121	6T6	121	121	6T6
3	306	150	71C1	13C2	150	71C1	13C2
3	307	71C1	71C1	13C2	71C1	71C1	13C2
3	308	C2A	C2A	13C2	C2A	150	100
3	309	150	150	13C2	150	71C1	100
3	319	121	120T2	6T6	121	120T2	6T6
3	320	150	60	100	150	60	100
3	322	150	150	100	150	150	34
3	323	150	150	100	71C1	71C1	100
3	325	150	150	13C2	C2A	C2A	13C2
3	326	150	71C1	100	150	150	100
3	327	150	71C1	100	150	150	13C2
3	328	C2A	C2A	13C2	150	150	13C2
3	331	71C1	150	100	150	150	100
3	332	C4	C4	13C2	C4	C4	85
3	333	71C1	71C1	100	71C1	71C1	100
3	335	71C1	C4	100	71C1	C4	100
3	338	C2A	150	100	150	150	100
3	339	C2A	C2A	100	C2A	C2A	100
3	340	C2A	C2A	13C2	C2A	C2A	13C2
3	341	C4	C4	100	C4	C4	100
3	342	C4	C4	13C2	C4	C4	13C2
3	344	24	150	13C2	24	150	13C2
3	346	150	24	100	150	150	34
3	347	150	150	6T6	121	10T10	13C2
3	348	150	150	11Q2	150	150	11Q2

Note: Arrangement codes not shown are available upon request. Contact Tyco Electronics.

Inserts available to accept AMP Mini-Expanded Beam or Junior Expanded Beam Fiber Optic Cable Assemblies. Custom design configurations can be provided.

Contact Tyco Electronics for more information about Expanded Beam Fiber Optic Connectors and Cable Assemblies, see Section 4, on pages 4001-4017.

Product Facts

- For Mini-Expanded Beam and Junior Expanded Beam inserts
- Insert holders designed to ARINC 600, Supplement 13 or to specific customer needs
- For use in 100 base-FX Ethernet LAN applications per ARINC 664 and 763
- Drop-in insert holders utilize standard ARINC 600 retainers
 - Hard stop on plug side
 - Spring-loaded stop on receptacle side
 - Captive hardware
- Sealing available
- Smaller size of Mini-Expanded Beam inserts permits greater packaging density

Inserts for Expanded Beam Fiber Optics

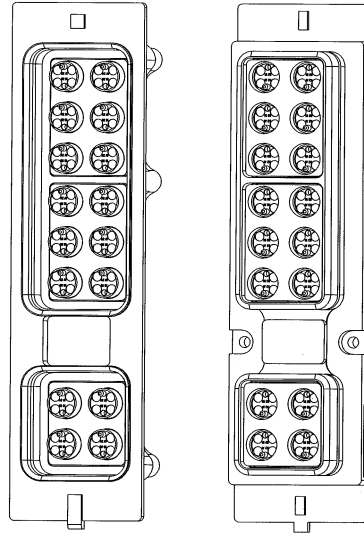

Junior Expanded Beam

Shell Size 2 or 3

Shell Module A, B, D or E

Shell Module C or F

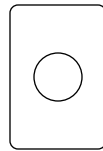

1 Position
1JS

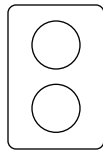

2 Position
2JS

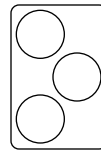

3 Position
3JS

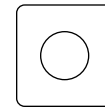

1 Position
1JP

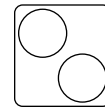

2 Position
2JP

Mini-Expanded Beam

Shell Size 1

Shell Module A or B

Shell Module C

Shell Module A, B, D or E

Shell Module C or F



3MS



2MP

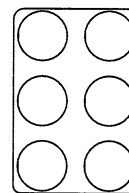

6MS

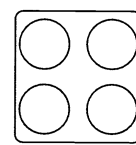

4MP

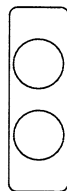

2MS



1MP

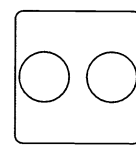

2MP

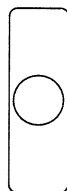

1MS

Shell Size 2 or 3

Keying

Notes:

1. Darkened portion of diagram indicates extended post of plug key; light portion indicates key hole in receptacle keyway.
2. If the keying code is omitted, keying is assembled in the 01 arrangement; the keying code is not stamped on the connector.
3. If the keying code is 00, keying is supplied unassembled.
4. Diagrams show mating face of connector, "Top" up.

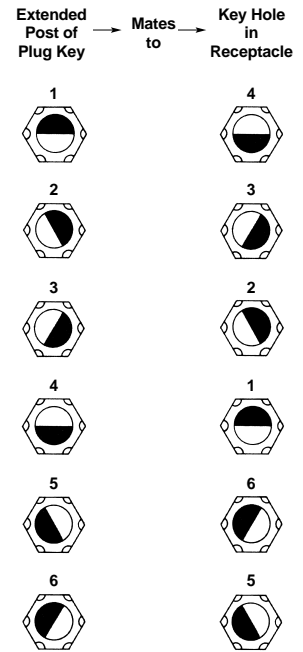
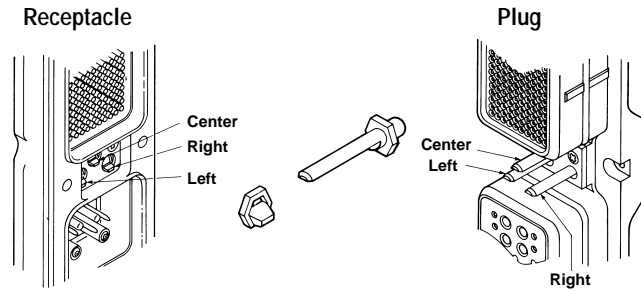

Keying Components	Quantity Required Per Connector	Part Numbers	
		Receptacle	Plug
Male Key Post	3	—	1218693-2
Female Keyway	3	208019-1	—
Plate	1	1218692-1	1218692-1
Screw	2	208021-1	208021-1
Kit Containing Above	1	448013-1	448012-1

Keying Code	Plug			Receptacle		
	Left Post	Center Post	Right Post	Left Keyway	Center Keyway	Right Keyway
00	—	—	—	—	—	—
01	1	1	1	4	4	4
02	2	1	1	4	4	3
03	3	1	1	4	4	2
04	4	1	1	4	4	1
05	5	1	1	4	4	6
06	6	1	1	4	4	5
07	1	1	6	5	4	4
08	2	1	6	5	4	3
09	3	1	6	5	4	2
10	4	1	6	5	4	1
11	5	1	6	5	4	6
12	6	1	6	5	4	5
13	1	1	5	6	4	4
14	2	1	5	6	4	3
15	3	1	5	6	4	2
16	4	1	5	6	4	1
17	5	1	5	6	4	6
18	6	1	5	6	4	5
19	1	1	4	1	4	4
20	2	1	4	1	4	3
21	3	1	4	1	4	2
22	4	1	4	1	4	1
23	5	1	4	1	4	6
24	6	1	4	1	4	5
25	1	1	3	2	4	4
26	2	1	3	2	4	3
27	3	1	3	2	4	2
28	4	1	3	2	4	1
29	5	1	3	2	4	6
30	6	1	3	2	4	5
31	1	1	2	3	4	4
32	2	1	2	3	4	3
33	3	1	2	3	4	2
34	4	1	2	3	4	1
35	5	1	2	3	4	6
36	6	1	2	3	4	5
37	1	2	1	4	3	4
38	2	2	1	4	3	3

Keying Code	Plug			Receptacle		
	Left Post	Center Post	Right Post	Left Keyway	Center Keyway	Right Keyway
39	3	2	1	4	3	2
40	4	2	1	4	3	1
41	5	2	1	4	3	6
42	6	2	1	4	3	5
43	1	2	6	5	3	4
44	2	2	6	5	3	3
45	3	2	6	5	3	2
46	4	2	6	5	3	1
47	5	2	6	5	3	6
48	6	2	6	5	3	5
49	1	2	5	6	3	4
50	2	2	5	6	3	3
51	3	2	5	6	3	2
52	4	2	5	6	3	1
53	5	2	5	6	3	6
54	6	2	5	6	3	5
55	1	2	4	1	3	4
56	2	2	4	1	3	3
57	3	2	4	1	3	2
58	4	2	4	1	3	1
59	5	2	4	1	3	6
60	6	2	4	1	3	5
61	1	2	3	2	3	4
62	2	2	3	2	3	3
63	3	2	3	2	3	2
64	4	2	3	2	3	1
65	5	2	3	2	3	6
66	6	2	3	2	3	5
67	1	2	2	3	3	4
68	2	2	2	3	3	3
69	3	2	2	3	3	2
70	4	2	2	3	3	1
71	5	2	2	3	3	6
72	6	2	2	3	3	5
73	1	3	1	4	2	4
74	2	3	1	4	2	3
75	3	3	1	4	2	2
76	4	3	1	4	2	1
77	5	3	1	4	2	6

Keying Code	Plug			Receptacle		
	Left Post	Center Post	Right Post	Left Keyway	Center Keyway	Right Keyway
78	6	3	1	4	2	5
79	1	3	6	5	2	4
80	2	3	6	5	2	3
81	3	3	6	5	2	2
82	4	3	6	5	2	1
83	5	3	6	5	2	6
84	6	3	6	5	2	5
85	1	3	5	6	2	4
86	2	3	5	6	2	3
87	3	3	5	6	2	2
88	4	3	5	6	2	1
89	5	3	5	6	2	6
90	6	3	5	6	2	5
91	1	3	4	1	2	4
92	2	3	4	1	2	3
93	3	3	4	1	2	2
94	4	3	4	1	2	1
95	5	3	4	1	2	6
96	6	3	4	1	2	5
97	1	3	3	2	2	4
98	2	3	3	2	2	3
99	3	3	3	2	2	2
100	4	3	3	2	2	1
101	5	3	3	2	2	6
102	6	3	3	2	2	5
103	1	3	2	3	2	4
104	2	3	2	3	2	3
105	3	3	2	3	2	2
106	4	3	2	3	2	1
107	5	3	2	3	2	6
108	6	3	2	3	2	5
109	1	4	1	4	1	4
110	2	4	1	4	1	3
111	3	4	1	4	1	2
112	4	4	1	4	1	1
113	5	4	1	4	1	6
114	6	4	1	4	1	5
115	1	4	6	5	1	4
116	2	4	6	5	1	3
117	3	4	6	5	1	2
118	4	4	6	5	1	1
119	5	4	6	5	1	6
120	6	4	6	5	1	5
121	1	4	5	6	1	4
122	2	4	5	6	1	3
123	3	4	5	6	1	2
124	4	4	5	6	1	1
125	5	4	5	6	1	6
126	6	4	5	6	1	5
127	1	4	4	1	1	4
128	2	4	4	1	1	3
129	3	4	4	1	1	2
130	4	4	4	1	1	1
131	5	4	4	1	1	6
132	6	4	4	1	1	5
133	1	4	3	2	1	4
134	2	4	3	2	1	3
135	3	4	3	2	1	2
136	4	4	3	2	1	1
137	5	4	3	2	1	6
138	6	4	3	2	1	5
139	1	4	2	3	1	4
140	2	4	2	3	1	3
141	3	4	2	3	1	2
142	4	4	2	3	1	1
143	5	4	2	3	1	6
144	6	4	2	3	1	5
145	1	5	1	4	6	4
146	2	5	1	4	6	3
147	3	5	1	4	6	2

Keying Code	Plug			Receptacle		
	Left Post	Center Post	Right Post	Left Keyway	Center Keyway	Right Keyway
148	4	5	1	4	6	1
149	5	5	1	4	6	6
150	6	5	1	4	6	5
151	1	5	6	5	6	4
152	2	5	6	5	6	3
153	3	5	6	5	6	2
154	4	5	6	5	6	1
155	5	5	6	5	6	6
156	6	5	6	5	6	5
157	1	5	5	6	6	4
158	2	5	5	6	6	3
159	3	5	5	6	6	2
160	4	5	5	6	6	1
161	5	5	5	6	6	6
162	6	5	5	6	6	5
163	1	5	4	1	6	4
164	2	5	4	1	6	3
165	3	5	4	1	6	2
166	4	5	4	1	6	1
167	5	5	4	1	6	6
168	6	5	4	1	6	5
169	1	5	3	2	6	4
170	2	5	3	2	6	3
171	3	5	3	2	6	2
172	4	5	3	2	6	1
173	5	5	3	2	6	6
174	6	5	3	2	6	5
175	1	5	2	3	6	4
176	2	5	2	3	6	3
177	3	5	2	3	6	2
178	4	5	2	3	6	1
179	5	5	2	3	6	6
180	6	5	2	3	6	5
181	1	6	1	4	5	4
182	2	6	1	4	5	3
183	3	6	1	4	5	2
184	4	6	1	4	5	1
185	5	6	1	4	5	6
186	6	6	1	4	5	5
187	1	6	6	5	5	4
188	2	6	6	5	5	3
189	3	6	6	5	5	2
190	4	6	6	5	5	1
191	5	6	6	5	5	6
192	6	6	6	5	5	5
193	1	6	5	6	5	4
194	2	6	5	6	5	3
195	3	6	5	6	5	2
196	4	6	5	6	5	1
197	5	6	5	6	5	6
198	6	6	5	6	5	5
199	1	6	4	1	5	4
200	2	6	4	1	5	3
201	3	6	4	1	5	2
202	4	6	4	1	5	1
203	5	6	4	1	5	6
204	6	6	4	1	5	5
205	1	6	3	2	5	4
206	2	6	3	2	5	3
207	3	6	3	2	5	2
208	4	6	3	2	5	1
209	5	6	3	2	5	6
210	6	6	3	2	5	5
211	1	6	2	3	5	4
212	2	6	2	3	5	3
213	3	6	2	3	5	2
214	4	6	2	3	5	1
215	5	6	2	3	5	6
216	6	6	2	3	5	5

- AA** Crimp, Snap-In Contacts, Rear Release, Standard Mounting
- AB** .025 [0.64] Square Post — 208215-1 Contacts, 1-Wrap High, Snap-In, Standard Mounting
- AC** .025 [0.64] Square Post — 208215-2 Contacts, 2-Wrap High, Snap-In, Standard Mounting
- AD** .025 [0.64] Square Post — 208215-3 Contacts, 3-Wrap High, Snap-In, Standard Mounting
- BA** (4) Floating Bushings

#6-32 Clinch Nuts, see Table 1 on page 3015 for clinch nut locations

- CA** (10) #6-32 Clinch Nuts
- CB** (4) #6-32 Clinch Nuts
- CC** (6) #6-32 Clinch Nuts
- CD** (8) #6-32 Clinch Nuts

Captivated Contact Codes

- DA** Captivated Inserts — No Contacts
- DF** 208275-7 (.150 [3.81] Extension), Standard Mounting
- DG** 208275-3 (.190 [4.83] Extension), Standard Mounting
- DH** 208275-4 (.250 [6.35] Extension), Standard Mounting

Clinch Nuts with Captivated Contacts, see Table 1 on page 3015 for clinch nut locations

- EA** (4) #6-32 Clinch Nuts, and 208275-7 Signal Contacts
- EB** (4) #6-32 Clinch Nuts, and 208275-3 Signal Contacts
- EC** (4) #6-32 Clinch Nuts, and 208275-4 Signal Contacts

Front Release, standard mounting

- FA** Indicates Front Release Inserts without Contacts
- FB** Standard Mounting, 211245-2 Contacts
- FC** Standard Mounting, 211245-4 Contacts
- FD** Standard Mounting, 211245-6 Contacts
- FE** Standard Mounting, 211431-2 Contacts
- FF** Standard Mounting, 211431-4 Contacts
- FG** Standard Mounting, 211431-6 Contacts
- FH** Standard Mounting, 211431-8 Contacts

Front Release Contacts and Clinch Nuts, see Table 1 on page 3015 for clinch nut locations

- GA** (4) #4-40 Clinch Nuts, 211431-4 Contacts
- GB** (6) #4-40 Clinch Nuts, 211431-4 Contacts
- GC** (6) #4-40 Clinch Nuts, 211431-6 Contacts
- GD** (6) #6-32 Clinch Nuts, 211431-4 Contacts
- GE** (10) #4-40 Clinch Nuts, 211431-8 Contacts
- GF** (6) #6-32 Clinch Nuts, 211431-2 Contacts
- GG** (4) #4-40 Clinch Nuts, 211431-2 Contacts
- GH** (4) #6-32 Clinch Nuts, 211431-2 Contacts
- GJ** (6) #6-32 Clinch Nuts, 211431-8 Contacts
- GK** (4) #6-32 Clinch Nuts, 211431-8 Contacts
- GL** (10) #6-32 Clinch Nuts, 211431-4 Contacts
- GM** (4) #6-32 Clinch Nuts, 211431-4 Contacts
- GN** (4) #6-32 Clinch Nuts, 211245-2 Contacts
- FJ** (10) #6-32 Clinch Nuts, 211245-4 Contacts
- FK** (6) #6-32 Clinch Nuts, 211245-4 Contacts

#4-40 Clinch Nuts, see Table 1 on page 3015 for clinch nut locations

- SA** (4) #4-40 Clinch Nuts
- SB** (6) #4-40 Clinch Nuts
- SC** (10) #4-40 Clinch Nuts
- SD** (8) #4-40 Clinch Nuts
- SE** (14) #4-40 Clinch Nuts
- SF** (6) #4-40 Clinch Nuts (Special)

Size 1 Receptacle Shell with Lugs Removed, see drawing below. See Table 1 on page 3015 for clinch nut locations

- HA** Size 1 Receptacle Shell
- HB** Size 1 Receptacle Shell — (4) #4-40 Clinch Nuts

Size 1 Receptacle

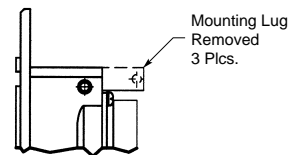

**Modification Code
HA and HB only**

Contact Style/Shell Modification Codes (Continued)

Table 1

Quantity	Clinch Nut Locations on Mounting Flange (Unless otherwise noted with modification code)		
	Shell Size		
	1	2	3
4	All	4 corners	4 corners
6	N/A	4 corners and 2 at polarizing keys	4 corners and 2 at polarizing keys
6 code SF only	N/A	See Figure 3	N/A
8	N/A	See Figure 4	See Figure 1
10	N/A	All	See Figure 2
14	N/A	N/A	All

Size 3 Receptacle

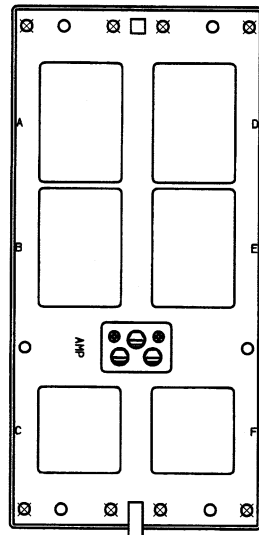

Figure 1
x = Clinch Nut Installed in These Holes

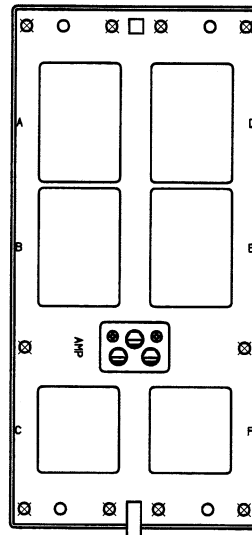

Figure 2
x = Clinch Nut Installed in These Holes

Size 2 Receptacle

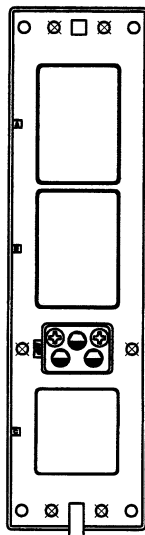

Figure 3
Modification Code SF Only
x = Clinch Nut Installed in These Holes

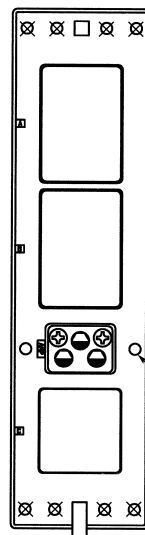

Figure 4
x = Clinch Nut Installed in These Holes

Ø .186
[4.72]
2 Plcs.

Contact Loading Codes

0 (or blank) — Contacts included

1 — Contacts not included; must be ordered separately by AMP Part Number.

Note: When connectors are ordered with contacts, the contact style section (AA in the example code at the top of this page) must be specified so that the proper, unloaded inserts are included. COAXICON contacts are not supplied in connector kits and must be ordered separately.

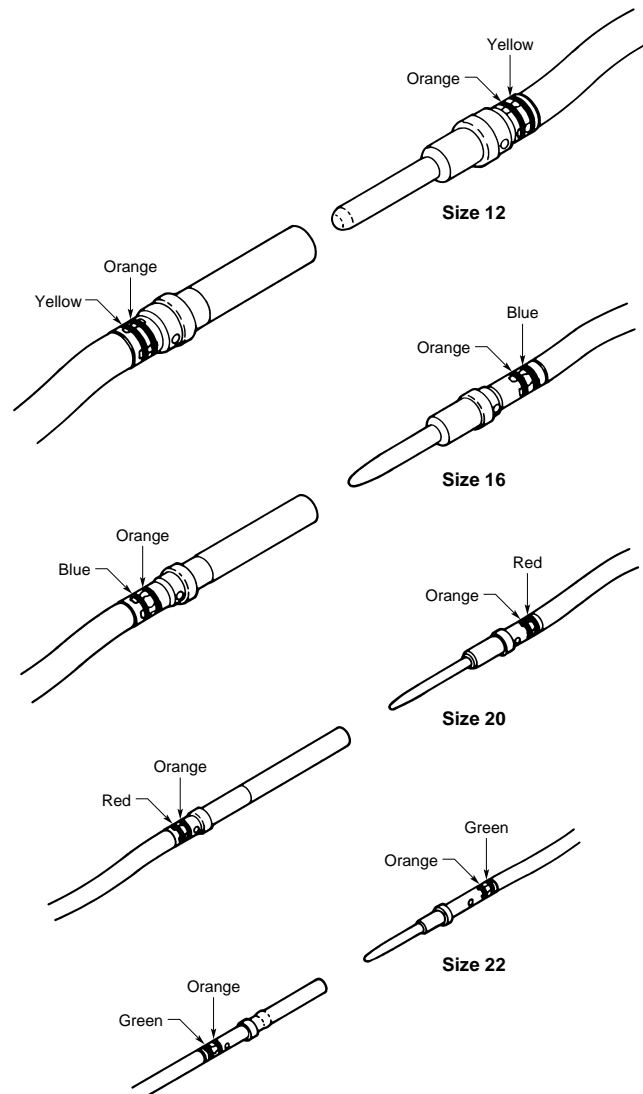

Insertion and Extraction



Typical Tool

Crimp, Snap-In, Rear-Release Contacts (also suitable for ARINC 404)

Average Contact Size	Wire Size		Color Code	Average Engagement Force	Part Numbers		Tooling Part Numbers			Color Code
	AWG	mm ²			Pin Contact	Socket Contact	Crimp Tool	Positioner	Insertion/Extraction Tool	
22	26-22	0.12-0.4	Green	1.5 oz. [.42 N]	208262-3	208264-2	M22520/2-01	M22520/2-23	91066-1	Green
20	24-20	0.2-0.6	Red	2.0 oz. [.56 N]	208265-3	208267-2	M22520/2-01	M22520/2-08	91066-4	Red
16	20-16	0.5-1.4	Blue	3.0 oz. [.83 N]	208268-3	208270-2	M22520/1-01	M22520/1-02	91066-3	Blue
12	14-12	2-3	Yellow	12.0 oz. [3.34 N]	208271-3	208273-2	M22520/1-01	M22520/1-11	445147-1	—

Size 22 Posted Contacts

Contact Loading

0 (or blank) — Contacts included

1 — Contacts not included; must be ordered separately.

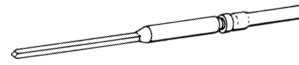

Square or Rounded Posts

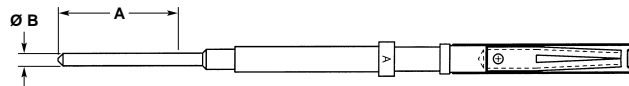

Round Post

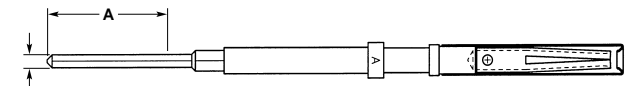

Square Post

Size 22, Snap-In, Rear Release Socket Contacts

Use Insertion/Extraction Tool
Part Number 91066-1

with .025 [0.64] Square Posts

Number of Wraps	Post Extension from Rear of Insert (Dim. A)	Part Number
1	0.275 6.98	208215-1
2	0.390 9.91	208215-2
3	0.520 13.21	208215-3

with Round Posts

Minimum Post Extension from Rear (Dim. A)	Post Diameter (Dim. B)	Part Number
0.190 4.82	0.025 0.64	445814-1
0.230 5.84	0.025 0.64	445814-2
0.180 4.57	0.020 0.51	445814-3

Size 22, Snap-In, Front Release Socket Contacts

Use Insertion/Extraction Tool
Part Number 445815-1

with Round Posts

Minimum Post Extension from Rear of Insert (Dim. A)	Post Diameter (Dim. B)	Part Number	Solder Dipped
0.150 3.81	0.025 0.64	211431-2	No
0.250 6.35	0.025 0.64	211431-4	No
0.375 9.52	0.025 0.64	211431-6	No
0.500 12.70	0.025 0.64	211431-8	No
0.150 3.81	0.0195 0.50	1-211431-0	No
0.250 6.35	0.0195 0.50	1-211431-2	No
0.150 3.81	0.030 0.76	1-211431-3	Yes
0.375 9.52	0.030 0.76	1-211431-4	Yes
0.250 6.35	0.025 0.64	1-211431-5	Yes

with .025 [0.64] Square Posts

Number of Wraps	Post Extension from Rear of Insert (Dim. A)	Part Number
1	0.250 6.35	211245-2
2	0.375 9.52	211245-4
3	0.500 12.70	211245-6

Posted Contacts (Continued)

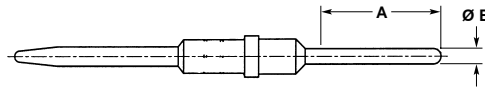

Size 16
Part Number 448139

Front Release/Remove
Size 12, Posted Pin Contacts
Use Insertion/Extraction Tool
Part Number 445147-1

Minimum Post Extension from Rear of Insert (Dim. A)	Post Diameter (Dim. B)	Part Number	Solder Dipped
0.264 6.70	.079-.083 2.01-2.11	448140-3	No
0.379 9.62	.079-.083 2.01-2.11	448140-6	No
0.264 6.70	.079-.083 2.01-2.11	448140-9	Yes
0.143 3.63	.079-.083 2.01-2.11	448140-8	No

Front Release/Remove
Size 16, Posted Pin Contacts
Use Insertion/Extraction Tool
Part Number 91066-3

Minimum Post Extension from Rear of Insert (Dim. A)	Post Diameter (Dim. B)	Part Number	Solder Dipped
0.379 9.62	.048-.052 1.22-1.32	448139-6	No
0.264 6.70	.048-.052 1.22-1.32	1-448139-1	No
0.233 5.91	.048-.052 1.22-1.32	1-448139-4	No
0.264 6.70	.048-.052 1.22-1.32	1-448139-5	Yes
0.143 3.63	.061-.064 1.55-1.63	448139-8	No

Front Release/Remove
Size 20, Posted Pin Contacts
Use Insertion/Extraction Tool
Part Number 91066-4

Minimum Post Extension from Rear of Insert (Dim. A)	Post Diameter (Dim. B)	Part Number	Solder Dipped
0.236 5.99	.030-.034 0.76-0.86	1-448138-2	No
0.272 6.90	.030-.034 0.76-0.86	1-448138-5	No
0.272 6.90	.030-.034 0.76-0.86	1-448138-6	Yes
0.236 5.99	.030-.034 0.76-0.86	1-448138-7	Yes

COAXICON Contacts

COAXICON Contacts

COAXICON Contacts are not supplied in connector kits; they must be ordered separately.

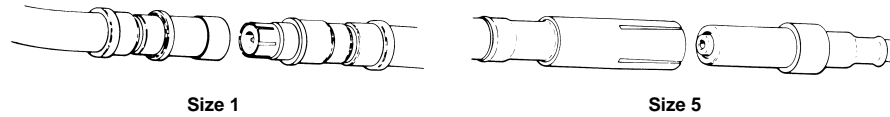

Size 1 Contacts

Performance Characteristics

- Nominal Impedance** — 50 ohms
- Frequency Range** — 0 to 5 GHz
- Operating Temperature** — -85°F to +329°F [-65°C to +165°C]
- Operating Voltage (Rated)** — 1000 VAC rms, 60 Hz at Sea Level
- Contact Resistance (Milliohms)** — 1.0 max. — Center Contact
0.2 max. — Outer Contact
- Insulation Resistance** — 5,000 megohms min. @ 500 vdc per MIL-STD-1344, Method 3003 or MIL-STD-202, Method 302, Cond. B

Dielectric Withstanding Voltage (60 Hz, rms)—

- RG 214/U 2500 at Sea Level
- RG 142/U 1900 at Sea Level

VSWR — 1.35 to 1.00 at 5 GHz

- Insertion/Withdrawal Force** — Insertion (max.) 15 lb [66.72 N]
Withdrawal (min.) 1 lb [4.45 N]

Cable Retention —

- RG 214/U 125 lb [556 N] min.
- RG 142/U 60 lb [266.9 N] min.

Thermal Shock — per MIL-STD-1344, Method 1003, Cond. A or MIL-STD-202, Method 107, Cond. A

Physical Shock — per MIL-STD-1344, Method 2004, Cond. D or MIL-STD-202, Method 213, Cond. D except 300 G max.

Vibration — per MIL-STD-1344, Method 2005, Cond. VI, Letter J or MIL-STD-202, Method 204, Cond. E except 42 G max.

Humidity Temperature Cycling — per MIL-STD-1344, Method 1002, Type II, Cond. A or MIL-STD-202, Method 106

Salt Spray — per MIL-STD-1344, Method 1001, Cond. B or MIL-STD-202, Method 101, Cond. B

Temperature Life — per MIL-STD-1344, Method 1005, Cond. D or MIL-STD-202, Method 108, Cond. D

Material and Finish

Contact — Beryllium Copper per ASTM-B-196/ASTM-B-197, Brass per ASTM-B-16, TEFLON per ASTM-D-1710, Silicon Rubber per ZZ-R-765, Gold plate per MIL-G-45204, Nickel plate per QQ-N-290

Ferrule — Copper per ASTM-B-188, Tin plate per ASTM-B-545

Size 1 (Captivated)

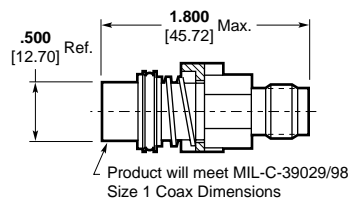
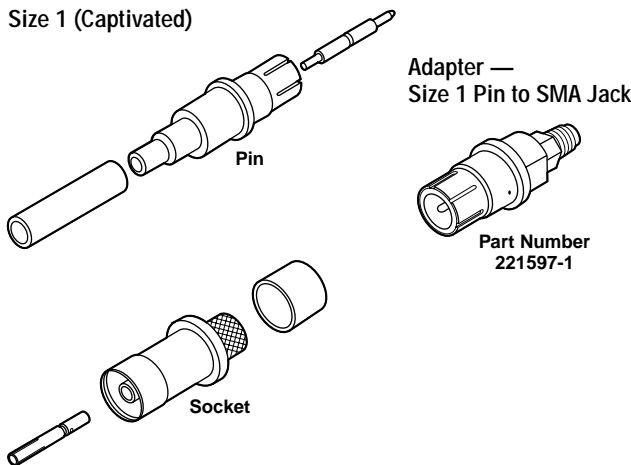

Adapter Standard Size 1 Socket to TNC Part Number 449908-1

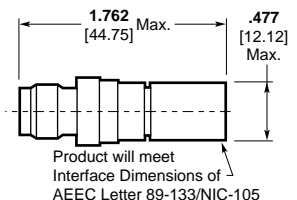

TCAS Size 1 Socket to TNC Adapter Part Number 447346-1

Contact Size	RG/U Cable	Contact Part No.		"O" Crimp Tooling			Military Hex Crimp Tooling				Compression Crimp Tooling		
				Center Contact			Center Contact		Ferrule				
				Pin	Socket	Tool (M22520/)	Positioner/ Die	Ferrule	Tool (M22520/)	Die (M22520/)	Tool (M22520/)	Die (M22520/)	Tool (M22520/)
O Crimp													
1	402 Semi-Rigid .141 [3.58]	225837-1	—	601966-1 (2-01)	1-601966-9	91905-1 ¹ or 91904 ¹	—	—	—	—	—	—	—
	402 Semi-Rigid .141 [3.58]	222018-1	—	—	—	—	—	—	—	—	59980-1 (36-01)	220220-2 (36-06)	312253-1 (36-03)
	405 Semi-Rigid .086 [2.18]	222018-2	—	—	—	—	—	—	—	—	59980-1 (36-01)	220220-2 (36-06)	312253-2 (36-02)
	214	—	225831-1 211229-1*	220015-1	—	220015-1	—	—	—	—	—	—	—
	142, 142A, 142B	—	225831-3 446709-1*	91902-1 ¹	—	91902-1 ¹	—	—	—	—	—	—	—
	393	—	225831-6 446709-3*	220015-1	—	220015-1	—	—	—	—	—	—	—
Military Hex Crimp													
1	214	447095-1	447087-1	—	—	—	608650-1 (5-01)	(5-25)	608650-1 (5-01)	(5-25)	—	—	—
	213	447095-2	447087-2 446709-5*	—	—	—	608650-1 (5-01)	(5-25)	608650-1 (5-01)	(5-25)	—	—	—
	142, 142A, 142B	447095-3	447087-3 446709-6*	—	—	—	608650-1 (5-01)	(5-11)	608650-1 (5-01)	(5-11)	—	—	—
	393	447095-4	447087-4 446709-7*	—	—	—	608650-1 (5-01)	(5-25)	608650-1 (5-01)	(5-25)	—	—	—
	ECS 311201	—	447087-5 446709-2*	—	—	—	608650-1 (5-01)	(5-29)	608650-1 (5-01)	(5-29)	—	—	—
Modified 1 Straight Exit	214	—	446549-3*	—	—	—	M22520/5-01**	—	—	M22520/5-25	—	—	M22520/5-25
	142	—	446549-1	—	—	—	M22520/5-01**	—	—	M22520/5-11	—	—	M22520/5-11
	393	—	446549-5*	—	—	—	M22520/5-01**	—	—	M22520/5-25	—	—	M22520/5-25
	Times AA5886	—	446549-6*	—	—	—	M22520/5-01**	—	—	M22520/5-25	—	—	M22520/5-04
	Times AA5887	—	446549-2*	—	—	—	M22520/5-01**	—	—	M22520/5-29	—	—	M22520/5-29
	ESC 311201	—	446549-4*	—	—	—	M22520/5-01**	—	—	M22520/5-29	—	—	M22520/5-29
	SMA ADAPTER	446748-1	—	—	—	—	—	—	—	—	—	—	—

*Socket with mounting hardware. Mounting hardware for Size 1 Straight Exit Contacts includes: backup plate, spring, retaining ring, O-ring, washers and screws.
 **Tyco Electronics does not sell Hand Tool M22520/5-01. However, it can be purchased from: Daniels Manufacturing Corp, 6103 Anno Ave., Orlando, FL 32809, 800-327-2432.

- Notes:**
1. SDE die used with hand tool frame 354940-1.
 2. Hardware kit for Size 1 COAXICON Socket Contacts (used on 71C1 or C2 inserts) includes all mounting hardware required (retention plate, washers, O-ring, spring, screws and retention clip). Kit Number 447118-1.
 3. Size 1 Coaxicon Pin Contacts require retention plate 211217-2 and four screws 211558-1.

COAXICON Contacts (Continued)

Size 5 and 8 Contacts

Performance Characteristics for size 5 contacts

- Nominal Impedance — 50 ohms
- Frequency Range — 0 to 500 MHz
- Operating Temperature — -85°F to +329°F [-65°C to +165°C]
- Operating Voltage (Rated) — 325 VAC rms, 60 Hz
- Contact Resistance (Milliohms) — Size 5 with RG 58/U cable:
Center Contact — 10
Outer Contact — 1.5

- Insulation Resistance — 5,000 megohms min. @ 500 vdc per MIL-STD-1344, Method 3003 or MIL-STD-202, Method 302, Cond. B
- Dielectric Withstanding Voltage (60 Hz, rms) — Sizes 5 with RG 58/U and 316/U cable:
750 - Sea Level
350 - 50,000 ft [15 240 m]
- VSWR — 1.3 to 1.0 @ 500 MHz
- Insertion/Withdrawal Force — Size 5:

Insertion Force Maximum		Withdrawal Force Minimum	
lb	[N]	lb	[N]
5	22.24	1	4.45

- Cable Retention — Size 5:
60 lb [266.9 N]
- Durability — 500 cycles
- Thermal Shock — per MIL-STD-1344, Method 1003, Cond. A or MIL-STD-202, Method 107, Cond. A
- Physical Shock — per MIL-STD-1344, Method 2004, Cond. A or MIL-STD-202, Method 213, Cond. A
- Vibration — per MIL-STD-1344, Method 2005, Cond. IV or MIL-STD-202, Method 204, Cond. D
- Moisture Resistance — per MIL-STD-202, Method 106, omit steps 7a and 7b

Salt Spray — 48 hours per MIL-STD-1344, Method 1001, Cond. B or MIL-STD-202, Method 101, Cond. B

Material and Finish

- Contact — Beryllium copper per ASTM-B-196/ASTM-B-197, Brass per ASTM-B-16, TEFLON per ASTM-D-1710, Gold plate per MIL-G-45204, Nickel plate per QQ-N-290
- Ferrule — Copper per ASTM-B-188, tin plate per ASTM-B-545

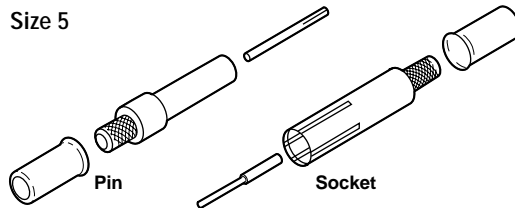

Size 5 Extraction Tool Part Number 91074-1

Contact Size	RG/U Cable	Contact Part No.		"O" Crimp Tooling			Military Hex Crimp Tooling			
		Pin	Socket	Center Contact			Center Contact		Ferrule	
				Tool (M22520/)	Positioner/Die	Ferrule	Tool (M22520/)	Die (M22520/)	Tool (M22520/)	Die (M22520/)
O Crimp										
5	58C	225790-1	225791-1	601966-1 (2-01)	1-601966-6 K345	91905-1*	—	—	—	—
	400, 142, 142A, 142B	225790-2	225791-2	91904-1*	—	91905-1*	—	—	—	—
	141A	225790-1	225791-1	91904-1*	—	91905-1*	—	—	—	—
	402 Semi-Rigid .141 [3.58]	225790-3	225791-6	91904-1*	—	91905-1*	—	—	—	—
	174, 188, 316	225790-5	225791-3	601966-1 (2-01)	1-601966-6 K345	91905-1*	—	—	—	—
	180, 195	225790-4	225791-8	601966-1 (2-01)	1-601966-6 K345	91905-1*	—	—	—	—
	179, 187	225790-6	225791-4	601966-1 (2-01)	1-601966-6 K345	91905-1*	—	—	—	—
	178, 196	225790-7	225791-5	601966-1 (2-01)	1-601966-6 K345	220020-1	—	—	—	—
	223	225790-2	225791-2	601966-1 (2-01)	1-601966-6 K345	91905-1*	—	—	—	—
Military Hex Crimp										
5	316 Double Shield 188 Double Shield	225790-8	1-225791-0	—	—	—	601966-1 (2-01)	1-601966-6 K345	608650-1 (5-01)	(Y159)
	58C, 141A	447850-1	447851-1	—	—	—	601966-1 (2-01)	1-601966-6 K345	608650-1 (5-01)	(5-45B)
	142, 142A, 142B	447850-2	447851-2	—	—	—	601966-1 (2-01)	1-601966-6 K345	608650-1 (5-01)	(5-45B)
	402 Semi-Rigid .141 [3.58]	447850-3	447851-3	—	—	—	601966-1 (2-01)	1-601966-6 K345	608650-1 (5-01)	(5-45A)
	174, 188, 316	447850-4	447851-4	—	—	—	601966-1 (2-01)	1-601966-6 K345	608650-1 (5-01)	(5-37B)

* SDE die used with hand tool frame 354940-1.

COAXICON Contacts (Continued)

Size 8 TWINAX/TRIAX/COAX Contacts

Size 8 Triax

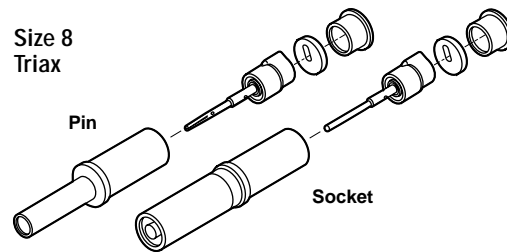

Size 8 Contact Extraction Tooling

Contact Style	Tool Part Number
Rear Release/Rear Remove	58284-1
Front Release/Front Remove	58284-1
Front Release/Rear Remove	448703-1

Contact Size	Style	Cable	Contact Part No.		Crimp Tooling	Crimp Tooling	
			Pin	Socket		Center Contact	Ferrule
8 TWINAX	RR/RR	M17/176-00002	—	222191-4	Hand Tool Frame M22520/5-01 (AMP 608650-1) Crimping Die AMP 58316-1 or Daniels Y793 or Y793A or AMP Hand Crimping Tool 91907-1*	—	—
	RR/RR	Tensolite 24463/9P025X-2(LD) or 24463/9B017X-2 (LD)	—	222191-5		—	—
	RR/RR	M17/176-00002	222190-4 (short engagement)	—		—	—
	RR/RR	Tensolite 24463/9P025X-2(LD) or 24463/9B017X-2 (LD)	222190-3 (short engagement)	—		—	—
	RR/RR	Tensolite 24463/9P025X-2(LD) or 24463/9B017X-2(LD)	448313-2 (long engagement)	—		—	—
	FR/RR	Tensolite 24463/9P025X-2(LD) or 24463/9B017X-2(LD)	448312-2 (long engagement)	—		—	—
8 TRIAX	FR/FR	Posted (.250 [6.35] min. post extension)	448541-1 (long engagement)	—	—	—	—
8 COAX	RR/RR	Adams Russell FC11Z	—	448543-1	—	M22520/2-01 (AMP 601966-1)	91907-1*
	RR/RR	Adams Russell FC14Z	—	448543-2	—	M22520/2-01 (AMP 601966-1)	91907-1*
	RR/RR	RG/U-316, 188	1218687-3 (long engagement)	1218820-1	—	M22520/2-01 (AMP 601966-1)	91907-1*
	RR/RR	RG/U-142	1218689-1 (long engagement)	1218821-1	—	M22520/2-01 (AMP 601966-1)	91907-1*
	FR/RR	Adams Russell FC11Z	448542-1 (long engagement)	—	—	M22520/2-01 (AMP 601966-1)	91907-1*
	FR/RR	Adams Russell FC14Z	448542-2 (long engagement)	—	—	M22520/2-01 (AMP 601966-1)	91907-1*
	FR/FR	Posted (.250 [6.35] min. post extension)	448540-2 (long engagement)	—	—	—	—

*SDE die used with hand tool frame 354940-1.

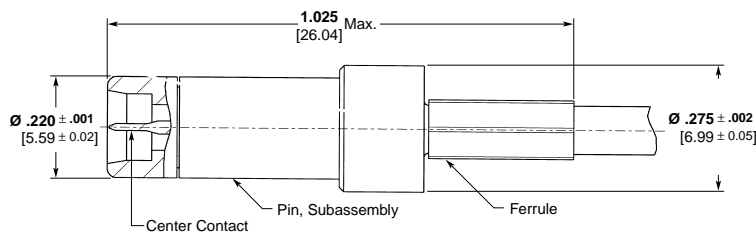

Pin

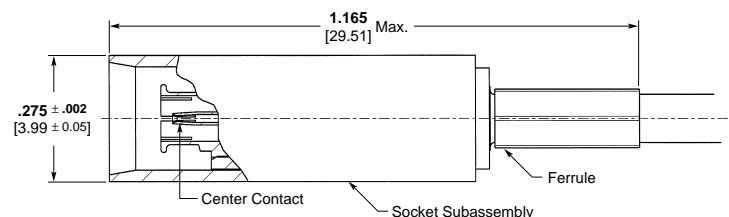

Socket

Size 5 COAX Contacts, Spring Loaded 75 Ohm

Style	Cable	Contact Part No.		Crimp Tooling	
		Pin	Socket	Center Contact	Braid
Rear Release/Rear Remove	RG/U-179	443971-1	443972-1	Daniels HMR Tool AFM8 or AMP 601966-1 with Daniels positioner K1289 (socket) or K1288S (pin)	Daniels HX4 with Die-set Y196 cavity A or AMP 35940-1 with Die-set 58483-1 Cavity B

ARINC Size 8 Quadrax Contacts

Product Facts

- Utilizes four size 24 screw-machined contacts with standard crimp tooling per M22520/2-01 and M22520/5-01 for ease of termination
- Front release/front removable PCB mount contact design for use in ARINC 600 receptacle connectors
- Rear release/rear remove crimp contact design for use in ARINC 600 plug connectors & receptacles
- Quadrax housing is keyed to assure mating alignment
- Contacts are on 2mm centerline per ARINC 600 specification
- Electrical:
 - 10/100/1000 Base-T Ethernet cable performance
 - 100 Ohm characteristic impedance
- Solder contact also available, see page 3024
- To extract Quadrax contact from connector insert, use Extraction Tool Part Number 58284-1

Pin and Socket contact assemblies for use with quad axial cable, per ARINC 664 & 763 specifications. Designed to fit inside ARINC 600 size 8 Quadrax connector cavities.

Adaptable to a variety of connectors (ARINC 600, 404, D-Subminiature connectors, MIL-C-38999, etc.)

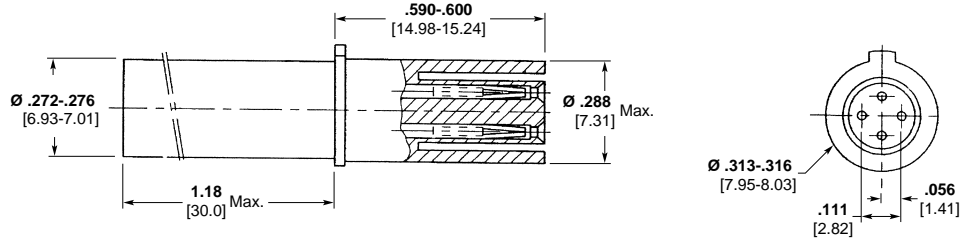
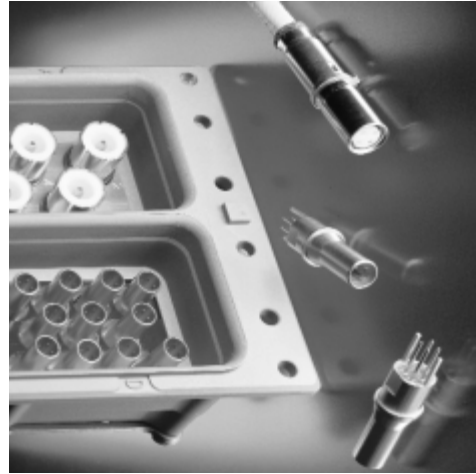

Size 8 Quadrax Socket Contact — Crimp Style Rear Release/Rear Remove Design Part Number 1445693-1

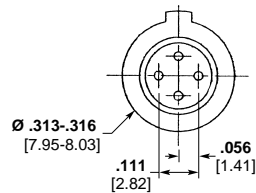

Size 8 Quadrax Pin Contact — Crimp Style Rear Release/Rear Remove Design Part Number 1445692-1

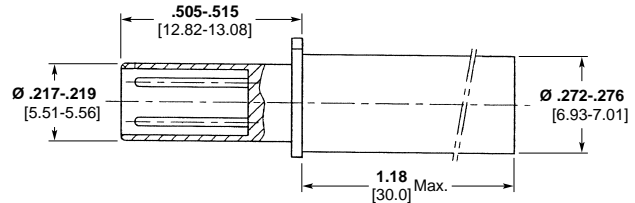

Size 8 Quadrax PCB Pin Contact Front Release/Front Remove Design Part Number 1445626-1

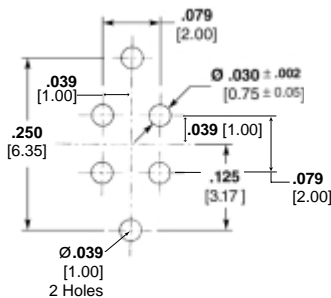

Hole Positioning for Front Release/Front Removable Design of PCB Size 8 Quadrax Contact

ARINC Size 2 Connectors	Insert Arrangement	Style	Shell Features	Contacts			
Part No.	Type	A	B	C			
1484373-1	Receptacle	150	Q11	13C2	Front Release Front Remove	Electroless Nickel Plated, with ten 4-40 clinch nuts	Size 22 signal & quadrax contacts supplied loaded in inserts; post extension = .15 [3.81]. Contacts supplied in 13C2 positions 1, 2, 3, 7 and 8 only
1484374-1	Plug	150	Q11	13C2	Rear Release Rear Remove	Electroless Nickel Plated, no clinch nuts	Crimp style size 22 signal and quadrax contacts supplied unloaded. Contacts supplied for 13C2: positions 1, 2, 3, 7 and 8 only
1484406-1	Receptacle	Q11	Q11	68Q2	Front Release Front Remove	Electroless Nickel Plated, no clinch nuts	Size 22 signal & quadrax contacts supplied loaded in inserts; post extension = .25 [6.35]
1484407-1	Plug	Q11	Q11	68Q2	Rear Release Rear Remove	Electroless Nickel Plated, no clinch nuts	Crimp style size 22 signal and quadrax contacts supplied unloaded

ARINC Size 8 Quadrax Solder Contacts

Product Features

- Four molded-in-place size 24 contacts using SolderSleeve technology
- Minimum parts count (2) simplifies termination
- Inspectable solder connections
- Outer body keyed for proper mating alignment
- Rear release / rear removable contacts
- Electrical:
 - 100 ohm characteristic impedance
 - 10Base-T/100Base-T Ethernet data rate compatibility
- Standard extraction tool applies

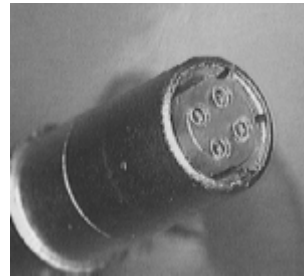
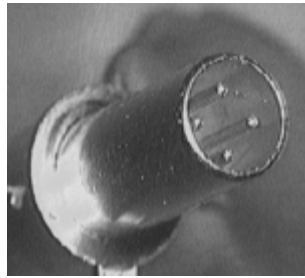

Pin and Socket contact assemblies for use with 100 ohm quadaxial cable in data networking applications per ARINC 600, 664 & 763 specifications.

Materials

Contact — Beryllium copper alloy 173, gold plated

Solder — SN96 per ANSI/J-STD-006

Flux — Type ROL1 per ANSI/J-STD-004 or RMA per QQ-S-571

Insulation Tubing — Heat shrinkable, radiation crosslinked polyvinylidene fluoride

Dielectric — MFA

Installation

Installation procedure in ES-61442
Holding fixture AD-1319-9 with adapter AT-1319-30

Product Offering

Part No	Type	Description
1604784	Pin	Kit including Pin Contact and Shield braid terminator
1604785	Socket	Kit including Socket Contact and Shield braid terminator

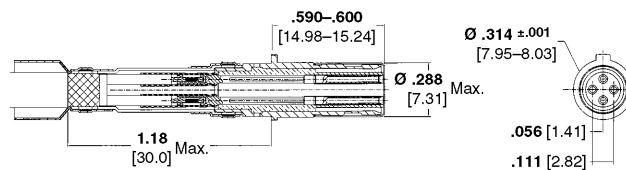
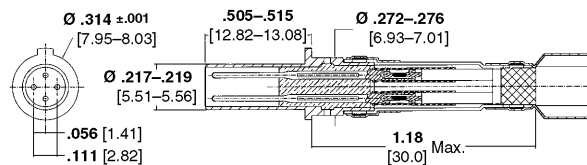

Traffic Alert and Collision Avoidance System (TCAS) Connectors and Mode S Transponder Connectors

Product Facts

Plug Connector

- AMP modified Size 1 coaxial contacts use standard military crimp tooling for reliable connections without the need for special tooling
- AMP plug allows repair or replacement of the coaxial contacts without connector disassembly. Two front-release captivated screws release the backup plate
- AMP connector conforms to the ARINC 600 specification, for connector intermateability and contact interchangeability

Receptacle Connector

- AMP modified Size 1 coaxial contact incorporates a SMA jack for easy assembly
- AMP connector conforms to the ARINC 600 specification, for connector intermateability and contact interchangeability

Connector	Description	Part Numbers	Descriptive Part Number
TCAS Plug	Semi-environmental w/o contacts	445717-1	NIC66 K 36 C 40 AA 1
	Semi-environmental w/contacts, w/o coaxial contacts	445717-2	NIC66 K 36 C 40 AA 0
	Non-environmental w/o contacts	445717-3	NIC66 K 36 A 40 AA 1
	Non-environmental w/contacts, w/o coaxial contacts	445717-4	NIC66 K 36 A 40 AA 0
	Non-environmental w/o contacts, (8) #6-32 clinch nuts	445717-5	NIC66 K 36 A 40 CD 1
	Semi-environmental w/o contacts, (10) #4-40 clinch nuts	445717-6	NIC66 K 36 A 40 SC 1
TCAS Receptacle	Front release w/o contacts	445718-1	NIC66 J 36 FA 40 FA 1
	Non-environmental w/contacts, w/o coaxial contacts	208972-5	NIC66 H 23 A 01 AA 0
Mode S Plug	Non-environmental w/o contacts	208972-7	NIC66 H 23 A 01 AA 1
	Environmental w/contacts, w/o coaxial contacts	208973-5	NIC66 H 23 B 01 AA 0
	Semi-environmental w/o contacts	208973-6	NIC66 H 23 C 01 AA 1
	Front release w/o contacts	211991-1	NIC66 G 23 FA 01 FA 1
Mode S Receptacle			

Note: All standard ARINC 600 shell modifications are available.

The TCAS System includes one mated pair of Size 3 ARINC 600 connectors, called TCAS Connectors. The plug connector is mounted in the rack, and the receptacle connector is in the avionics box.

The TCAS System also includes one or two mated pairs of Size 2 ARINC 600 Connectors, called Mode S Transponder Connectors. The plug connectors are mounted in the rack, and the receptacle connectors are in the avionics box.

Contact Requirements

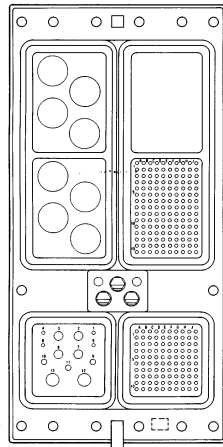

TCAS Connector Insert Arrangement (Receptacle Mating Face Shown)

Plug Contacts

No. of Contacts	Contact Size	Contact Sex	Part Number
250	22	pin	208262-3
4	20	socket	208267-2
3	16	socket	208270-2
4	12	socket	208273-2
2	5 coax	socket	***
8	1 coax-Mod.	socket	**

Receptacle Contacts

No. of Contacts	Contact Size	Contact Sex	Part Number
250	22	socket	*
4	20	pin	208265-3
3	16	pin	208268-3
4	12	pin	208271-3
2	5 coax	pin	***
8	1 coax-Mod.	pin	**

* See page 3017 for part numbers.
 ** See page 3020 for part numbers.
 *** See page 3021 for part numbers.

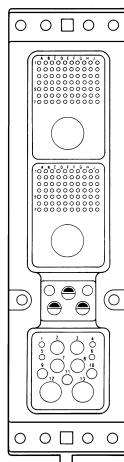

Mode S Transponder Insert Arrangement

Plug Contacts

No. of Contacts	Contact Size	Contact Sex	Part Number
140	22	pin	208262-3
4	20	socket	208267-2
3	16	socket	208270-2
4	12	socket	208273-2
2	5 coax	socket	***
2	1 coax	socket	**

Receptacle Contacts

No. of Contacts	Contact Size	Contact Sex	Part Number
140	22	socket	*
4	20	pin	208265-3
3	16	pin	208268-3
4	12	pin	208271-3
2	5 coax	pin	***
2	1 coax	pin	**

* See page 3017 for part numbers.
 ** See page 3020 for part numbers.
 *** See page 3021 for part numbers.

Single Mod ARINC 600

Descriptive Numbering

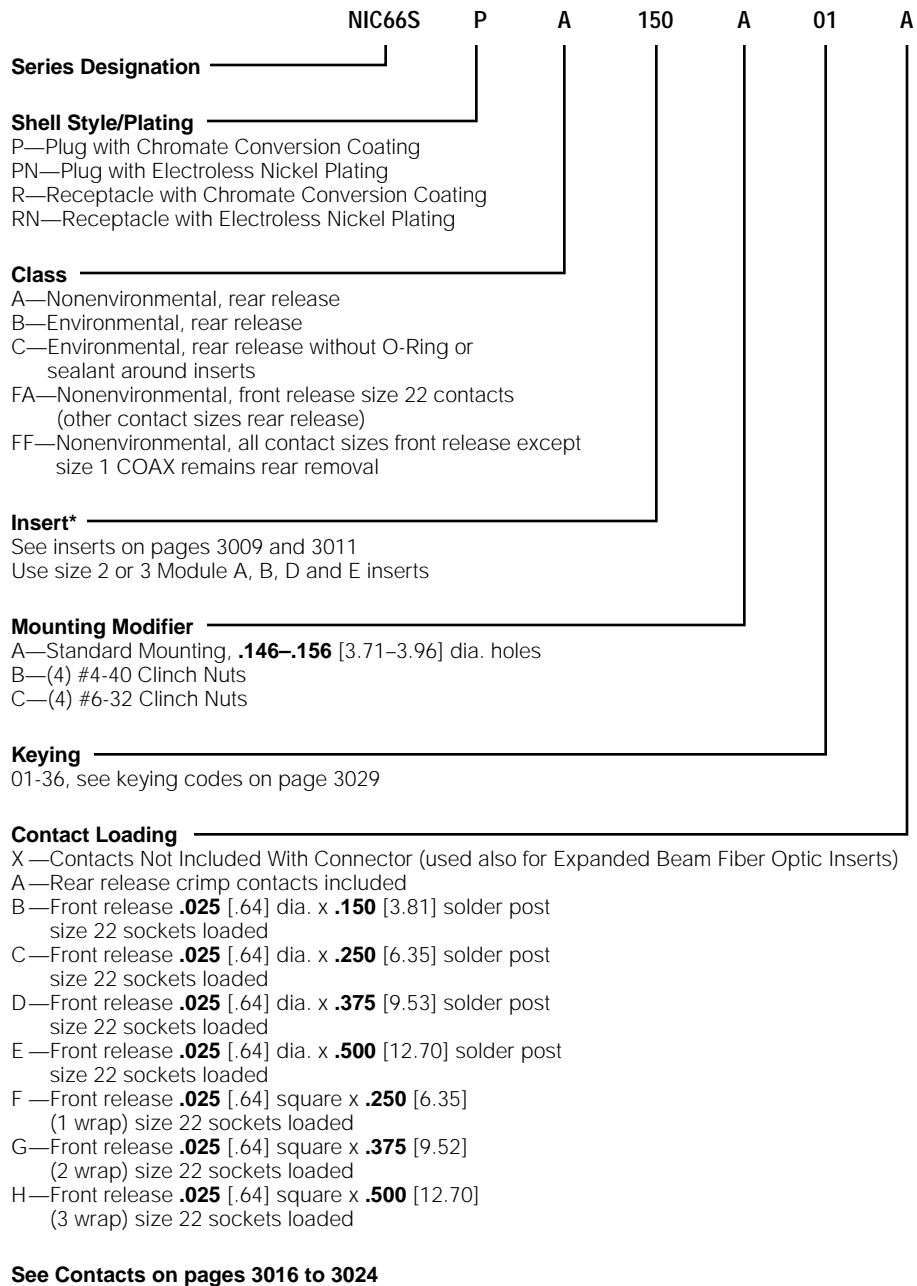

* Expanded Beam Fiber Optic inserts can also be used — must use signal cavity inserts identified as 1JS, 2JS, 3JS, or 6MS. See page 3011 or contact Tyco Electronics for more information.

Keying and Polarization

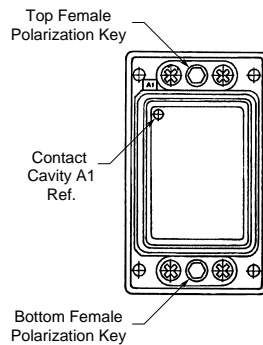

Receptacle (Box Side)

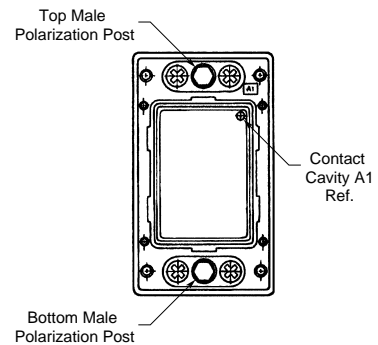

Plug (Rack Side)

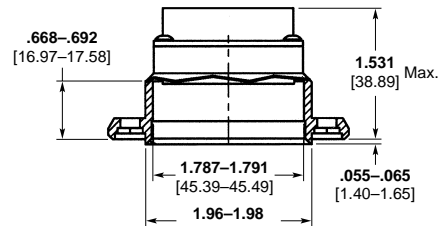
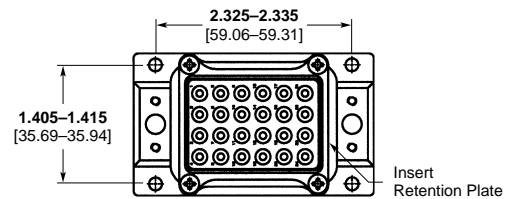

View Shown Without Keying Hardware

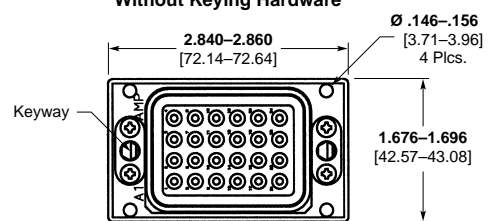
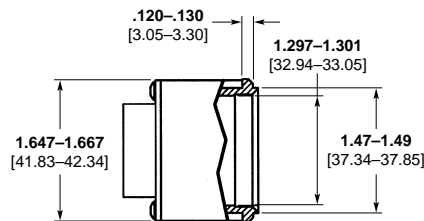

Single Mod Receptacle

Single Mod ARINC 600 (Continued)

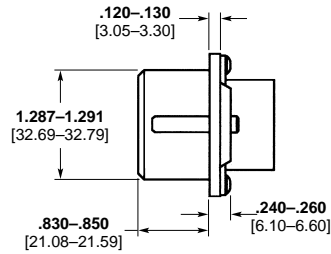

Single Mod Plug

Extended Post of Plug Key → Mates to → Key Hole in Receptacle

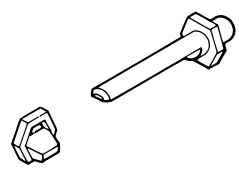
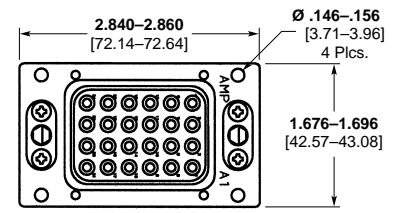
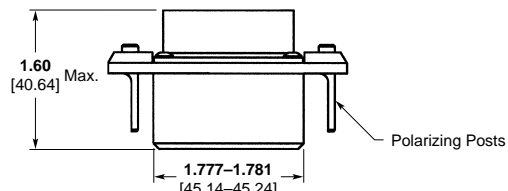
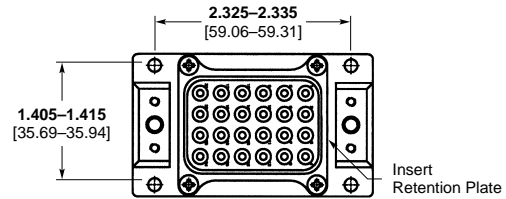
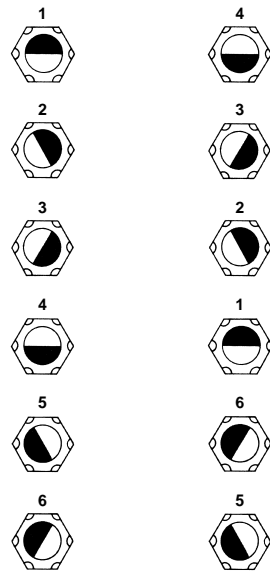

Keying Code	Receptacle		Plug	
	Top Key	Bottom Key	Top Post	Bottom Post
01	1	1	4	4
02	3	4	2	1
03	2	4	3	1
04	1	4	4	1
05	6	4	5	1
06	5	4	6	1
07	4	5	1	6
08	3	5	2	6
09	2	5	3	6
10	1	5	4	6
11	6	5	5	6
12	5	5	6	6
13	4	6	1	5
14	3	6	2	5
15	2	6	3	5
16	1	6	4	5
17	6	6	5	5
18	5	6	6	5

Keying Code	Receptacle		Plug	
	Top Key	Bottom Key	Top Post	Bottom Post
19	4	1	1	4
20	3	1	2	4
21	2	1	3	4
22	4	4	1	1
23	6	1	5	4
24	5	1	6	4
25	4	2	1	3
26	3	2	2	3
27	2	2	3	3
28	1	2	4	3
29	6	2	5	3
30	5	2	6	3
31	4	3	1	2
32	3	3	2	2
33	2	3	3	2
34	1	3	4	2
35	6	3	5	2
36	5	3	6	2

EMI/Ground Spring

EMI/Ground Spring Performance Data Comparison

	Cantilever Style	Canted Coil Style
Mating/Un-mating Force Results Design Objective = < 15 lbs for size 2 shell	6 lbs/3 lbs	14 lbs/6 lbs
Durability	500 min. mating/un-mating cycles	
EMI Test Results (Size 2 Shell) 100 to 1,000 MHz Design Objective = 65 dB @ 100 MHz and 60 dB @ 1,000 MHz	89 dB min. 93 dB average	88 db min. 92 dB average
Field Repairable	No	Yes

Canted Coil Spring Design

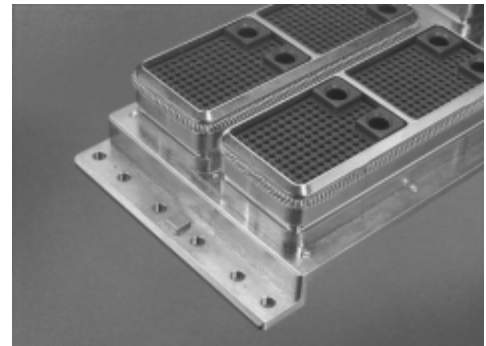
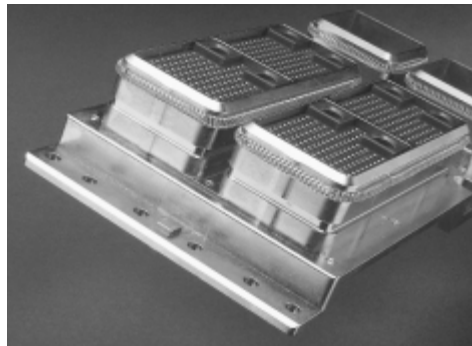

Cantilever Spring Design

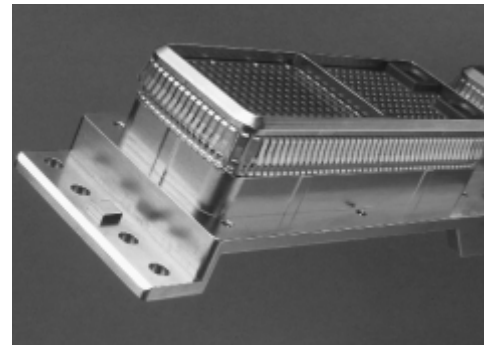
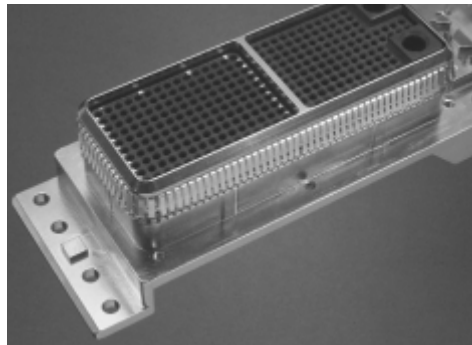

Note: ARINC 600 connectors can be supplied with either canted coil spring or cantilever spring design, contact Tyco Electronics.

Recommended Panel Cutouts

Shell Size 1

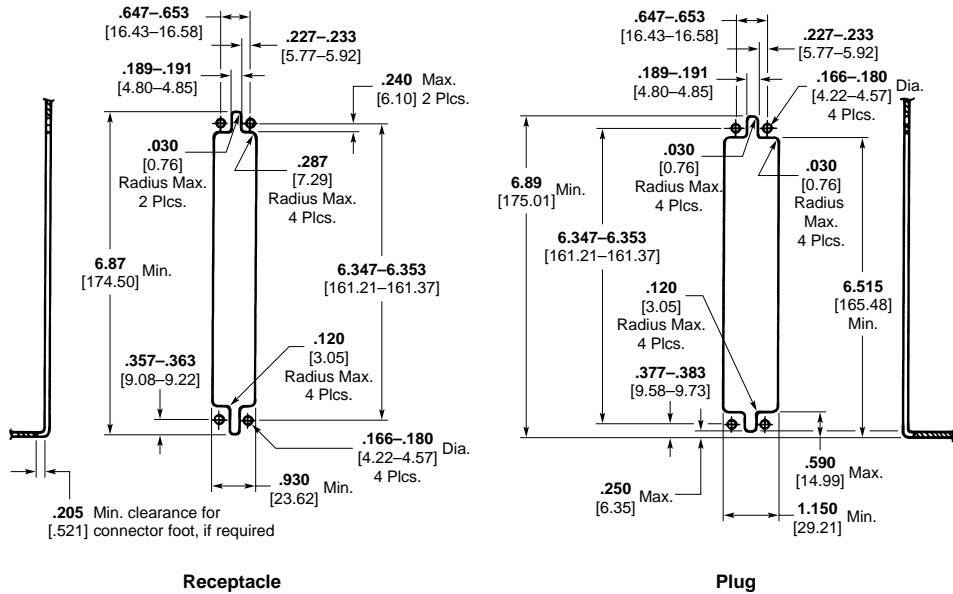

Shell Size 2

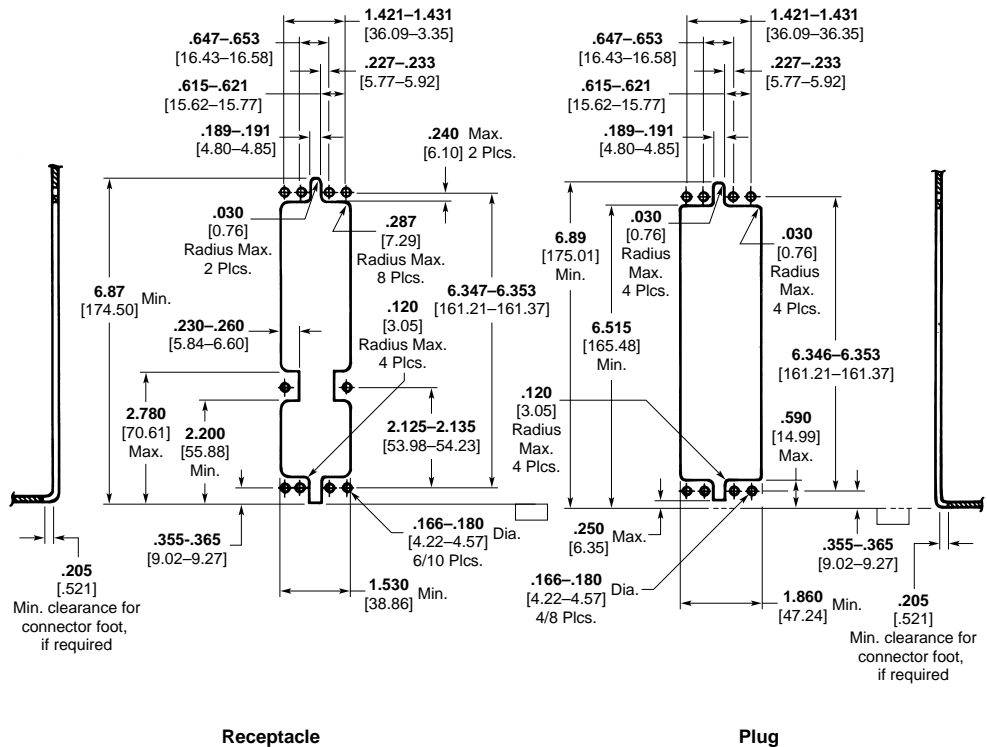

Note: These drawings are for reference only. For detailed mounting instructions, see the ARINC 600 specification.

Recommended Panel Cutouts (Continued)

Shell Size 3

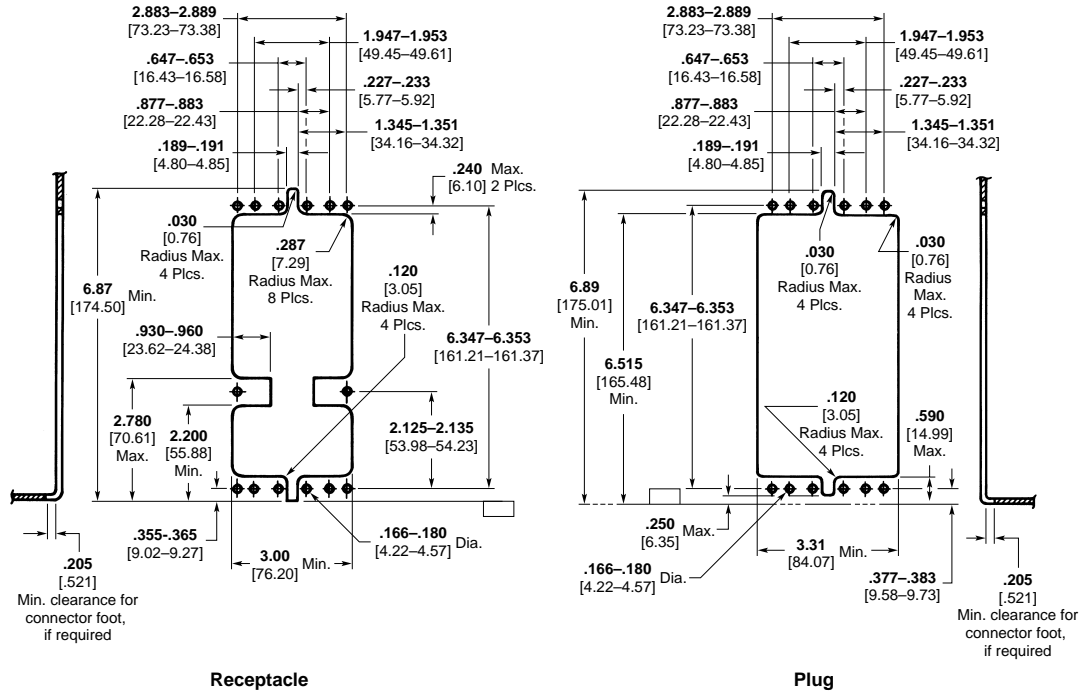

Accessories

Materials and Finish

Body — Copper alloy, .000015 [0.000381] min. gold per MIL-G-45204 over .000040 [0.00102 min. nickel per QQ-N-290
End Cap — TEFLON

Size 5 coax to size 12 contact cavity reducer. Insert into size 5 coax cavity to convert to a size 12 power contact cavity.

Cavity Reducer Socket
 Part Number 446744-1

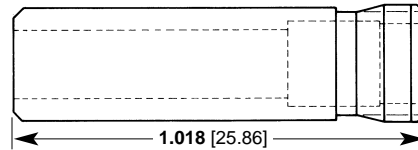

Dust Covers, Conductive

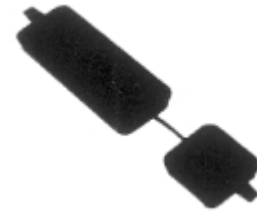

Connector Size(s)	Part Number
1	211600-1
2 & 3	211600-2

Cavity Reducer Pin
 Part Number 446743-1

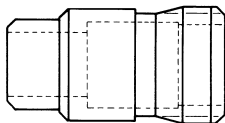

Coaxial Sealing Plug and Boot

Material — Silicone Rubber
 Size 5

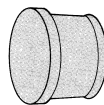

Plug—Part Number 205975-1

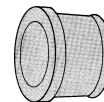

Boot for RG-58C cable—Part Number 205402-2
 Boot for RG-180, -190 cable—Part Number 205402-3

Sealing Plugs

Size 22



Part Number 204760-1
 White TEFLON

Size 20



Part Number 203839-1
 Red thermoplastic

Size 16



Part Number 203839-2
 Blue thermoplastic

Size 12



Part Number 205574-1
 Yellow thermoplastic

Application Tooling and Insertion/Extraction Tooling

Hand Crimping Tools

These standard military-type hand tools terminate screw-machined pins and sockets to wire with an 8-indent crimp per MIL-C-22520. They are ideal for prototype, field maintenance and other applications where volume is not a factor.

Tool Number 601967-1 is suitable for crimping wire range 26 AWG [0.12–0.15 mm²] to 12 AWG [3 mm²]. Tool Number 601966-1 is suitable for crimping wire range 32 AWG [0.03 mm²] to 20 AWG [0.5-0.6 mm²].



AMP Part Number 601966-1
MIL Number M22520/2-01

**AMP-TAPEMATIC
4/8 Indent Stripper-Crimper
Machine, 599406-7**

Portable bench machine that strips wire and crimps tape-mounted, closed-barrel pin and socket contacts for AMPLIMITE Military, ARINC and CPC connectors. The stripping and crimping heads are accessible through separate openings in the front of the machine. Wire strip length and crimp height are adjustable. The stripping head is pre-set to the proper cutting depth of four standard wire sizes.

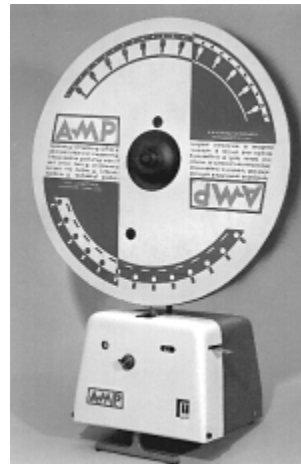

Specifications

- Width** — 12.5 [317]
- Depth** — 12.5 [317]
- Height** — 10 [254] without reel
- Weight** — 45 lb [20 kg]
- Electrical** — 120 VAC, 60 Hz, 1.3 A
- Wire Range** — 28-20 AWG [0.08-0.5 mm²]

**Application Tooling Instruction Sheet
Cross Reference**

Tool Number	Instruction Sheet
601966-1	408-7516
601967-1	408-7516
599406-7	408-7516

Insertion/Extraction Tools, ARINC 600

Tool Part Number	Product Line	Contact Size	Contact Type	Color Code	Style
91066-1	ARINC 600	22	Signal	Green	Rear Release/Rear Remove
91066-4	ARINC 600	20	Signal	Red	Rear Release/Rear Remove and Front Release/Front Remove
91066-3	ARINC 600	16	Signal	Blue	Rear Release/Rear Remove and Front Release/Front Remove
445147-1	ARINC 600	12	Signal	—	Rear Release/Rear Remove and Front Release/Front Remove
445815-1	ARINC 600	22	Signal	—	Front Release/Front Remove
58284-1	ARINC 600	8	Twinax/Triax/Coax/Quadax	—	Rear Release/Rear Remove and Front Release/Front Remove
448703-1	ARINC 600	8	Twinax/Triax/Coax	—	Front Release/Rear Remove
91074-1	ARINC 600	5	Twinax/Triax/Coax	—	Rear Release/Rear Remove and Front Release/Front Remove

For convenience, certain connectors have been assigned conventional AMP production part numbers, as shown in this table. These parts may be ordered using the AMP numbers or by using descriptive part numbers.

Cross Reference

Description	AMP Designation	AMP Part No.
Size 1 Receptacle, Unsealed	NIC66E11A00AA0	1-208599-1
	NIC66E11A00AA1	1-208599-5
	NIC66E11A01AA0	208599-1
	NIC66E11A01AA1	208599-2
	NIC66E11A03AA1	208599-7
	NIC66E11A11AA0	1-208599-0
	NIC66E11A12AA0	1-208599-3
	NIC66E11A12CB0	208599-4
	NIC66E11A16AA0	208599-9
	NIC66E11A19CB1	208599-3
	NIC66E11A22AA1	208599-5
	NIC66E11A23AA0	208599-8
	NIC66E11A50AA0	208599-6
	NIC66E11B01AA0	208600-1
Size 1 Receptacle, Sealed	NIC66E11B01AA1	208600-2
	NIC66E11B54AA0	208600-3
Size 1 Receptacle, Front Release	NIC66E11FA01FA1	448482-1
	NIC66E11FA01FF0	448482-2
Size 1 Plug, Unsealed	NIC66F11A00AA0	208597-7
	NIC66F11A01AA0	208597-1
	NIC66F11A01AA1	208597-2
	NIC66F11A03AA0	208597-4
	NIC66F11A03CB1	208597-9
	NIC66F11A06CB1	1-208597-3
	NIC66F11A08AA1	1-208597-2
	NIC66F11A08CB0	1-208597-5
	NIC66F11A10AA1	1-208597-6
	NIC66F11A13AA0	208597-5
	NIC66F11A13AA1	208597-6
	NIC66F12A02AA0	208597-8
	NIC66F12A02CB0	1-208597-4
	NIC66F14A01AA0	1-208597-0
	NIC66F11B01AA0	208598-1
	NIC66F11B01AA1	208598-2
Size 1 Plug, Sealed	NIC66F11B22AA1	208598-4
	NIC66F11C00AA1	1-208598-2
NIC66F11C01AA1	208598-3	
Size 2 Receptacle, Unsealed	NIC66G21A00AA0	1-208970-4
	NIC66G21A01AA0	208970-1
	NIC66G21A01AA1	208970-4
	NIC66G21A01AC0	208970-2
	NIC66G21A01BA1	208970-5
	NIC66G21A01CA0	1-208970-1
	NIC66G21A01CC0	2-208970-3
	NIC66G21A01CC1	208970-6
	NIC66G21A01SB1	208970-3
	NIC66G21A01SC1	1-208970-8
	NIC66G21A02AA0	1-208970-3
	NIC66G21A02AA1	1-208970-2
	NIC66G21A02CC0	2-208970-2
	NIC66G21A05CC0	2-208970-4
	NIC66G21A09CC0	1-208970-0
	NIC66G21A19AA0	1-208970-7
NIC66G26A01AA0	1-208970-6	
Size 2 Receptacle, Sealed	NIC66G21B01AA0	208971-1
	NIC66G21B01AA1	208971-2
	NIC66G21B04AA0	208971-4
	NIC66G21B05AA0	208971-3

Cross Reference (Continued)

Description	AMP Designation	AMP Part No.
	NIC66G20FA00FA1	3-211991-3
	NIC66G20FA01FA1	3-211991-4
	NIC66G20FA03FB0	2-211991-0
	NIC66G20FA08FB0	2-211991-1
	NIC66G21FA FA1	211991-2
	NIC66G21FA00CC1	211991-9
	NIC66G21FA01CC1	1-211991-0
	NIC66G25FA01FA1	211991-3
	NIC66G21FA01FC0	1-211991-1
	NIC66G21FA01GD0	211991-5
	NIC66G21FA01GJ0	3-211991-5
	NIC66G21FA01SB1	211991-6
	NIC66G21FA02FF0	1-211991-4
Size 2 Receptacle, Front Release	NIC66G21FA04FF0	3-211991-0
	NIC66G21FA06GF0	2-211991-7
	NIC66G21FA07GD0	3-211991-7
	NIC66G21FA09GD0	1-211991-6
	NIC66G22FA00CC1	2-211991-4
	NIC66G23FA00CC1	2-211991-2
	NIC66G23FA01FA1	211991-1
	NIC66G23FA02FA1	1-211991-7
	NIC66G23FA91FA1	211991-4
	NIC66G25FA00CC1	2-211991-3
	NIC66G26FA01FA1	211991-8
	NIC66G26FA68GD0	1-211991-2
	NIC66G29FA01FA1	1-211991-8
	NIC66G29FA02FA1	3-211991-6
	NIC66H20A AA0	2-208972-8
	NIC66H20A00AA0	3-208972-5
	NIC66H20A08AA1	4-208972-0
	NIC66H21A00AA0	1-208972-6
	NIC66H21A01AA0	208972-1
	NIC66H21A01AA1	208972-2
	NIC66H21A02AA0	1-208972-4
	NIC66H21A02AA1	1-208972-2
	NIC66H21A03AA0	3-208972-6
	NIC66H21A06AA0	3-208972-7
	NIC66H21A14AA0	1-208972-1
	NIC66H22A01AA1	208972-8
	NIC66H22A13AA0	2-208972-0
	NIC66H23A00CB1	3-208972-2
	NIC66H23A01AA0	208972-5
	NIC66H23A01AA1	208972-7
Size 2 Plug, Unsealed	NIC66H23A01CB1	1-208972-8
	NIC66H23A02AA0	2-208972-3
	NIC66H23A05AA0	2-208972-1
	NIC66H25A01AA0	208972-9
	NIC66H25A01AA1	1-208972-0
	NIC66H26A00AA1	3-208972-4
	NIC66H26A01AA0	1-208972-5
	NIC66H26A01AA1	1-208972-3
	NIC66H26A01SA1	2-208972-2
	NIC66H51A00AA0	2-208972-4
	NIC66H52A00AA0	3-208972-0
	NIC66H52A03AA0	3-208972-9
	NIC66H53A01AA0	2-208972-5
	NIC66H53A08AA0	449836-1
	NIC66H54A01AA1	2-208972-9
	NIC66H56A09AA0	449837-1
	NIC66H272A00AA0	1218867-2

Cross Reference (Continued)

Description	AMP Designation	AMP Part No.	
Size 2 Plug, Sealed	NIC66H20B03AA0	2-208973-8	
	NIC66H20B08AA0	2-208973-9	
	NIC66H20B40AA1	3-208973-8	
	NIC66H20C00AA0	3-208973-1	
	NIC66H21B01AA0	208973-1	
	NIC66H21B01AA1	1-208973-0	
	NIC66H21B04AA0	1-208973-3	
	NIC66H21B05AA0	1-208973-2	
	NIC66H21B06CD0	3-208973-3	
	NIC66H21B06CD1	3-208973-4	
	NIC66H21B40AA1	3-208973-9	
	NIC66H21C00AA0	3-208973-0	
	NIC66H21C01AA0	208973-3	
	NIC66H21C06CD0	3-208973-5	
	NIC66H21C09AA0	3-208973-2	
	NIC66H21C29AA0	2-208973-0	
	NIC66H23B01AA0	208973-5	
	NIC66H23B08AA0	1-208973-4	
	NIC66H23C01AA1	208973-6	
	NIC66H25C01AA0	208973-7	
	NIC66H25C01AA1	208973-8	
	NIC66H26B01AA1	2-208973-2	
	NIC66H26B02AA1	1-208973-1	
	NIC66H52B03AA0	4-208973-0	
	Size 3 Receptacle, Unsealed	NIC66J31A00AA0	208974-4
		NIC66J31A01AA0	208974-1
		NIC66J31A01AA1	208974-3
	Size 3 Receptacle, Sealed	NIC66J34A01AA0	208974-5
		NIC66J31B01AA0	208975-1
	Size 3 Receptacle, Front Release	NIC66J31B01AA1	208975-3
NIC66J31FA00CA1		1-211992-1	
NIC66J31FA01FA1		211992-1	
NIC66J31FA01FF0		211992-4	
NIC66J31FA01FH0		211992-5	
NIC66J31FA03FA1		211992-6	
NIC66J31FA27FA1		211992-7	
NIC66J32FA00FA1		211992-3	
Size 3 Plug, Unsealed	NIC66K31A00AA0	208976-5	
	NIC66K31A01AA0	208976-1	
	NIC66K31A01AA1	208976-3	
	NIC66K32A01AA0	208976-7	
	NIC66K33A01AA0	208976-6	
	NIC66K33A01AA1	208976-2	
	NIC66K34A01AA0	208976-8	
	NIC66K36A40CD1	445717-5	
Size 3 Plug, Sealed	NIC66K31B01AA0	208977-1	
	NIC66K31B01AA1	208977-3	
	NIC66K31B01BA0	208977-8	
	NIC66K31C01AA1	208977-5	
	NIC66K33B01AA1	208977-2	
	NIC66K33C01AA1	208977-4	
	NIC66K34C01AA1	208977-7	
NIC66K36C40CD1	1-445717-7		

Introduction

Connectors with wide range of shell configurations/modifications, contact arrangements and contacts to meet ARINC 404 Specification and MIL-C-81659. The descriptive part numbering scheme described on the following pages can be used for ordering.

Commercial Series

- R — Unsealed
- RM — Interface seal on pin insert
- RME — Environmentally sealed

Unkeyed Single-Insert Series

- RMA — Standard size, unkeyed single-insert connectors, unsealed
- RMAE — same as RMA, except sealed

Military Series

- M — MIL qualified, unsealed
- MM — MIL qualified, interface seal on pin inserts
- MME — MIL qualified, environmentally sealed

Miniature Series

- RA — Unsealed
 - RE — Sealed
- Special connectors are also available—including connectors for flexible flat cable, for wire wrap-type terminations, and with contacts for board-mount applications.

Screw-machined pin and socket contacts for connector inserts—Signal contact sizes 22, 20, 16 and 12 for terminating wire range of 30 through 12 AWG [0.05–3 mm]. Crimp snap styles for rear-remove, rear-release applications are most common. They can be supplied both in loose-piece form, or can be tape-mounted for high-speed application.

Coax contact sizes 1, 3, 5, 7, 10 and 15 are available.

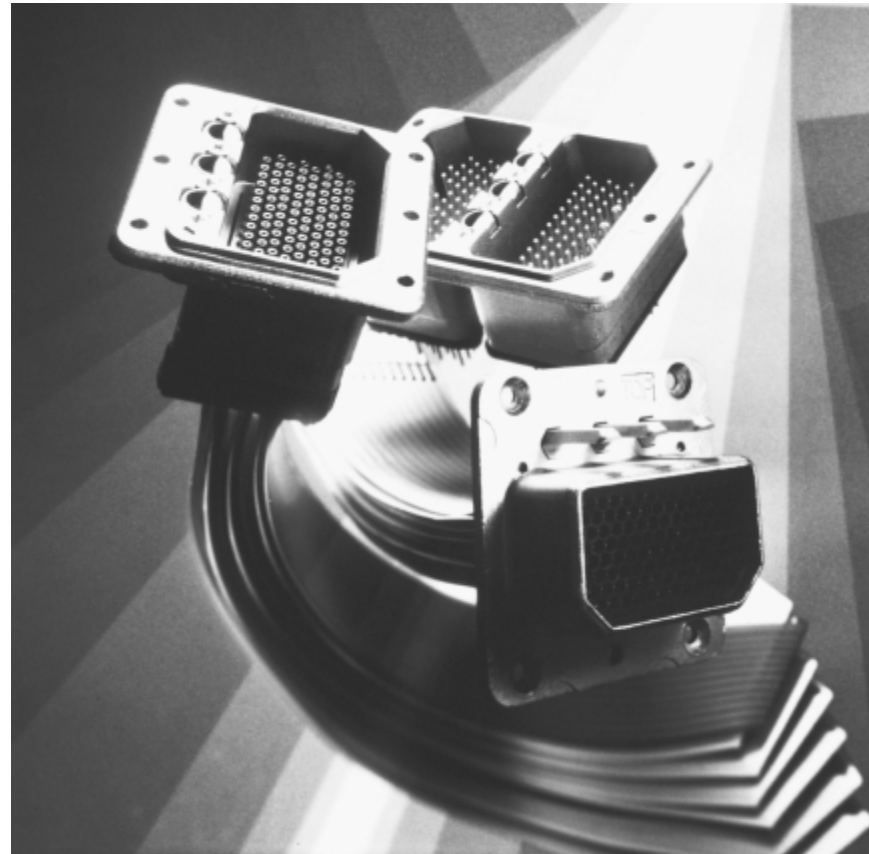

Material Specifications

Shell — Die-cast aluminum alloy per QQ-A-591; cadmium plated with yellow chromate conversion, or electroless nickel plated per QQ-P-416

Insert Retention Plates — (M, MM, R, RM, RME series) Aluminum alloy, blue anodized per MIL-A-8625 or electroless nickel plated per QQ-P-416; (MME series) Aluminum alloy, powder coat blue epoxy; (RA, RE series) Stainless steel, passivated

Screws and Washers — Stainless steel, passivated

Dielectric Hard — Epoxy

Dielectric, Interface Seal (Receptacle only) and Wire Sealing Grommets — Silicone rubber

Keying Posts and Nuts (Plug Only) — Stainless steel, passivated

Keyways (Receptacle Only) — Commercial — Aluminum
Military — Stainless steel

Performance Specifications

Environmentally sealed RME series connectors are designed per Military Specification MIL-C-81659 and all signal pin and socket contacts per MIL-C-39029. M, MM and MME series connectors are qualified and 100 percent inspected for conformation to MIL-C-81659.

Insulation Resistance — 5000 megohms

Dielectric Withstanding Voltage (Unmated at Sea Level) —
Test (contact arrangements 32C2, 33C4, 67 & 106) 1000 volts rms (all other contact arrangements, except C2 & C3) 1500 volts rms

Operate (contact arrangements 33C4, 67 & 106) 400 volts rms (all other contact arrangements, except C2 & C3) 500 volts rms

Temperature Range — -85°F to 257°F [-65°C to +125°C]

Contact Current Rating (tested in free air per MIL-C-34029) —

- (See pages 3048-3050 for information on coaxial contacts)
- Size 22 (22 AWG wire) [0.3-0.4 mm²] 5.0 amps
- Size 20 (20 AWG wire) [0.5-0.6 mm²] 7.5 amps
- Size 16 (16 AWG wire) [1.25-1.4 mm²] 13.0 amps
- Size 12 (12 AWG wire) [3 mm²] 23.0 amps

Contact Retention —

- Size 22 15 lb. (min.) [67 N]
- Size 20 20 lb. (min.) [89 N]
- Size 16 25 lb. (min.) [92 N]
- Size 12 30 lb. (min.) [134 N]

Durability (Mating and Unmating) — 500 cycles

Salt Spray — MIL-STD-1344, Method 1001, Condition B

Vibration — MIL-STD-1344, Method 2005, Condition IV

Ordering Information

Descriptive Part Numbering System

Use this page as a guide to construct part numbers for complete connector packages. Contacts must be ordered separately, except as specified in the Custom Order Code.



Single-insert receptacle connector shown
RM 1 R 106S-00 01 (200)

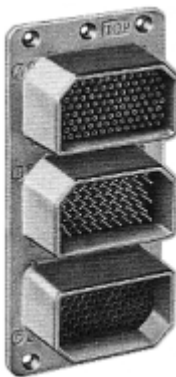

Three-insert plug connector shown
RM 3 P 106S 57P 106-00 00 (200)



Four-insert plug connector shown
RME 4 P 106P 106P 106 106S 00 00 (250)

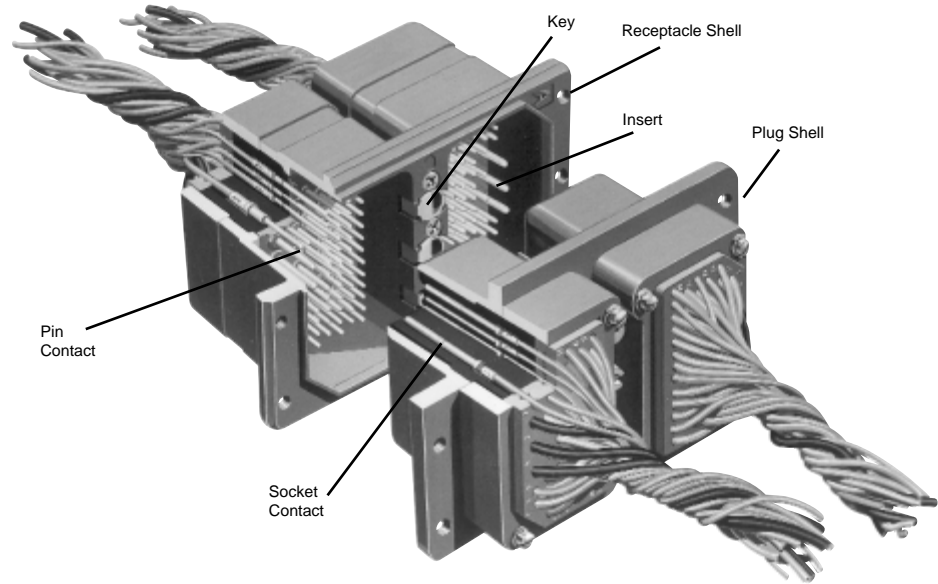

Note: Two-Insert Recept. Shell Dim. (Typ.)—3.075 [78.11] L x 2.000 [50.8] W x 1.665 [42.29] Depth

Sample Descriptive Part Number

RME 2 P 57 S 57 S — 00 01 (201)

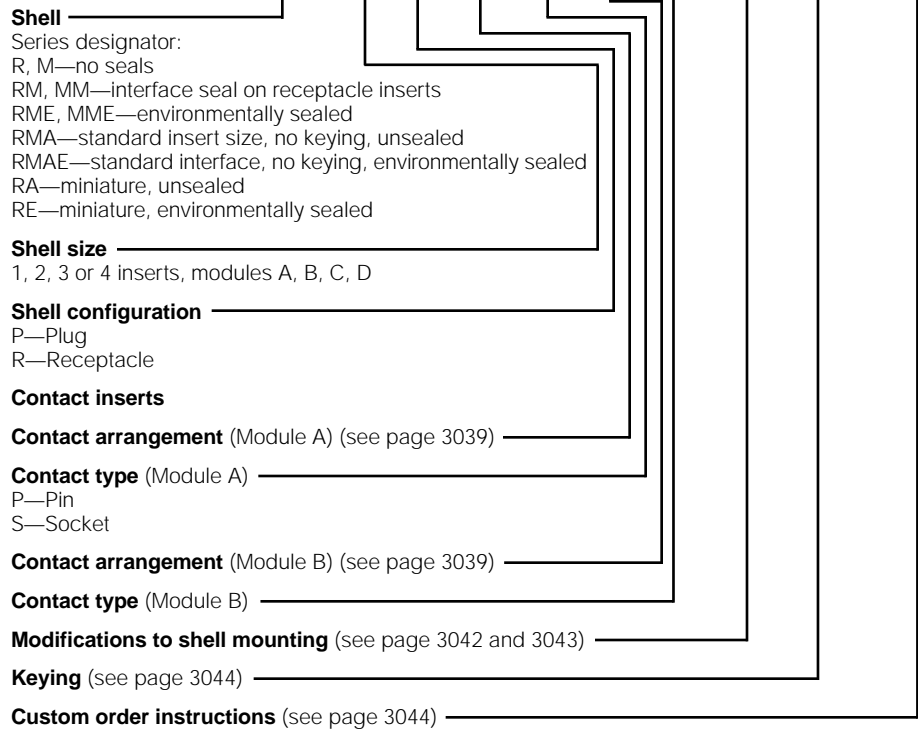

Contacts (see page 3045 and 3046 for ordering details)

Sealing boots

SPECIAL CONNECTORS

- Wrap-type assemblies
- RA, RE shells and inserts
- Assemblies for flexible flat cable
- RMA shell

Note: RMA/RMAE are only available in single-insert unkeyed shells.

One- and Two-Insert Shells

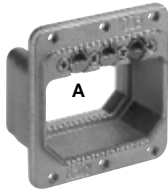

One-Insert Shells
(Receptacle Shown)

Example: RME 1 P 57S — 00 01 (200)

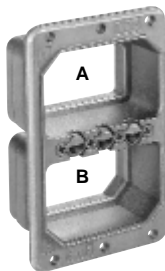
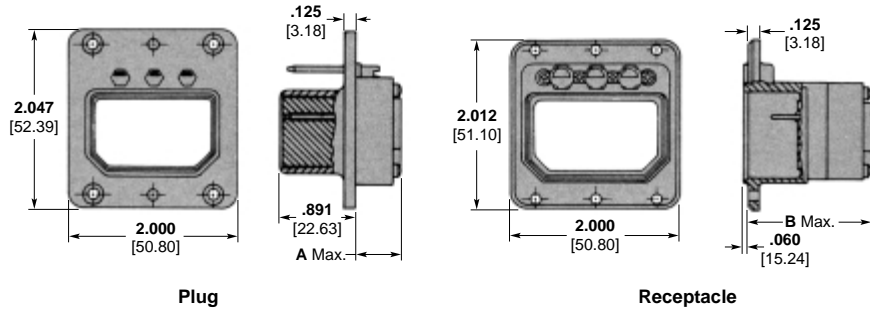

Two-Insert Shells
(Receptacle Shown)

Example: RM 2 P 57S 57S — 00 01 (200)

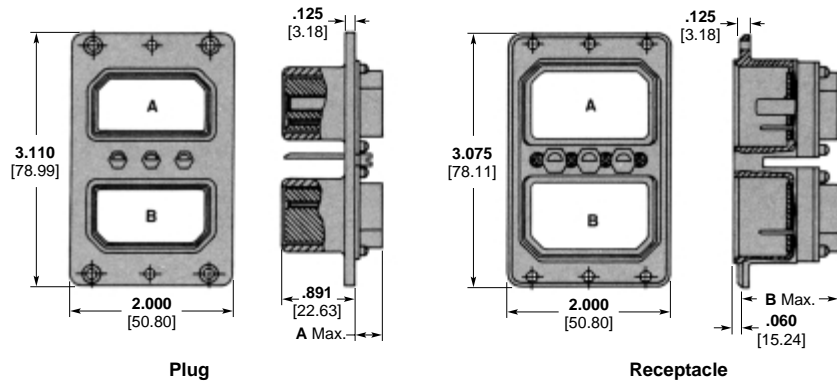

Maximum extension of connector behind flange, with insert.

Contact Arrangement	Dimensions			
	A Max. (Plug)		B Max. (Receptacle)	
	R, M, RM, MM	RME, MME	R, M, RM, MM	RME, MME
C2	.075 1.91	.075 1.91	1.016 25.81	1.016 25.81
C3	.075 1.91	.075 1.91	1.016 25.81	1.016 25.81
8	.314 7.98	.534 13.56	1.253 31.83	1.465 37.21
C8	.512 13.00	—	1.452 36.88	—
D8	.314 7.98	.534 13.56	1.253 31.83	1.465 37.21
26	.314 7.98	.534 13.56	1.253 31.83	1.465 37.21
32C2	.529 13.44	.734 18.64	1.465 37.21	1.665 42.29
32C4	.410 10.41	.615 15.62	1.350 33.86	1.555 39.50
33C4	.529 13.44	.734 18.64	1.465 37.21	1.665 42.29
40	.314 7.98	.534 13.56	1.253 31.83	1.465 37.21
40C1	.529 13.44	.734 18.64	1.465 37.21	1.665 42.29
45	.314 7.98	.534 13.56	1.253 31.83	1.465 37.21
57	.314 7.98	.534 13.56	1.253 31.83	1.465 37.21
67	.314 7.98	.534 13.56	1.253 31.83	1.465 37.21
106	.075 1.91	.279 7.09	1.016 25.81	1.219 30.96

Three- and Four-Insert Shells

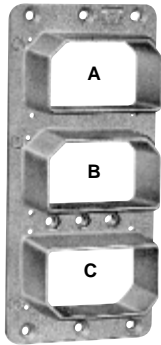

Three-Insert Shells
(Plug Shown)

Example: RME 3 P 57S 57S 57S — 00 01 (200)

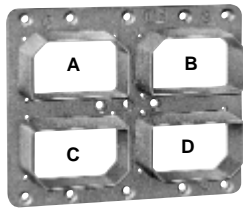
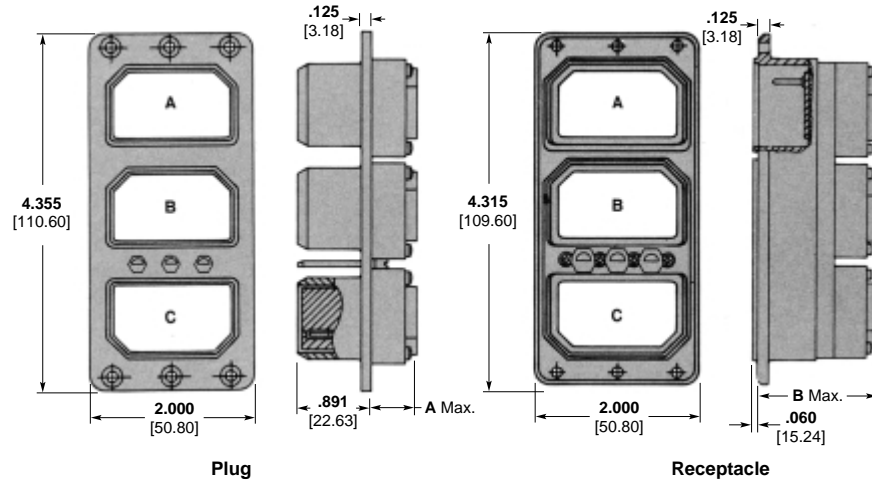

Four-Insert Shells
(Plug Shown)

Example: RME 4 P 57S 57S 57S 57S — 00 01 (200)

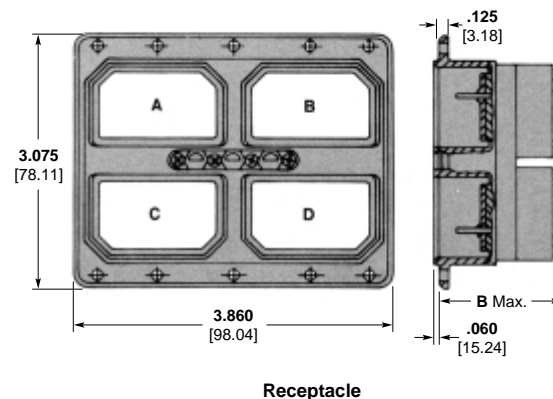
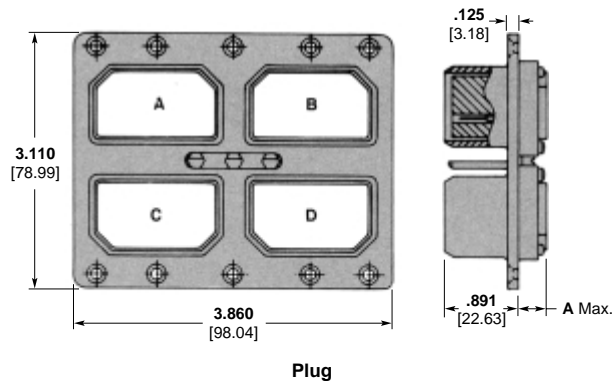

Note: Dimensions A and B refer to maximum connector depth with contact inserts installed. These dimensions are tabulated on page 3039.

Contact Inserts

Inserts for Series R, RM, RME; M, MM, MME, and RMA



Arrangement 106, environmental version shown

Legend

- Size 22 contact cavity
- Size 20 contact cavity
- Size 16 contact or Size 15 COAXICON contact cavity
- Size 12 contact cavity
- COAXICON contact cavity, except Size 15

Notes: 1. Size 22 socket contacts extend beyond the mating face of inserts; size 22 pin contacts are recessed. Size 20, 16 and 12 pins are exposed; size 20, 16 and 12 sockets are recessed.
2. Mating face of pin-contact insert is shown. Socket-contact insert face is mirror image.



Arrangement 33C4 shown

Example: RME 2 P 57S 67S — 00 01 (201)

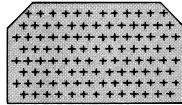

Arrangement 106
106 Size 22 contacts

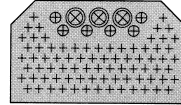

Arrangement 88
79 Size 22 contacts,
6 Size 20 contacts,
3 Size 16 contacts or
3 Size 15 COAXICON contacts

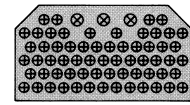

Arrangement 67
64 Size 20 contacts,
3 Size 16 contacts or
3 Size 15 COAXICON contacts

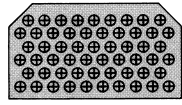

Arrangement 57
57 Size 20 contacts

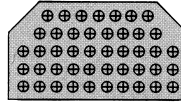

Arrangement 45
45 Size 20 contacts

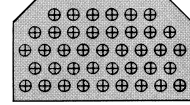

Arrangement 40
40 Size 20 contacts

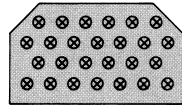

Arrangement 26
26 Size 16 contacts or
26 Size 15 COAXICON contacts

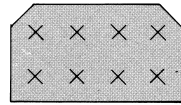

Arrangement 8
8 Size 12 contacts

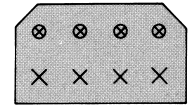

Arrangement D8
4 Size 12 contacts,
4 Size 16 contacts or
4 Size 15 COAXICON contacts

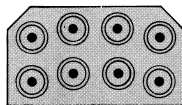

Arrangement C8
8 Size 9 COAXICON contacts
For unsealed connectors only

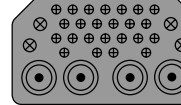

Arrangement 32C4
4 Size 16 contacts,
24 Size 20 contacts and
4 Size 9 COAXICON contacts

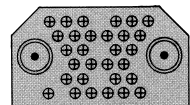

Arrangement 32C2
30 Size 20 contacts,
2 Size 5 COAXICON contacts

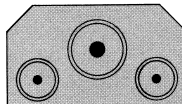

Arrangement C3
1 Size 3 COAXICON contact,
2 Size 7 COAXICON contacts
For unsealed connectors only
(Consult Tyco Electronics
for availability.)

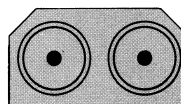

Arrangement C2
2 Size 1 COAXICON contacts
For unsealed connectors only
(Consult Tyco Electronics
for availability.)

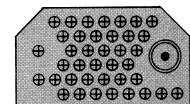

Arrangement 40C1
39 Size 20 contacts,
1 Size 5 COAXICON contact

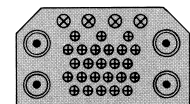

Arrangement 33C4
25 Size 20 contacts
4 Size 16 contacts or
4 Size 15 COAXICON contacts,
4 Size 5 COAXICON contacts

ARINC 404 Insert Holders for Mini Expanded Beam Contacts

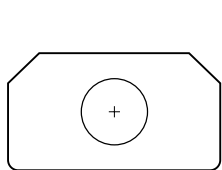

ARINC 404, 1 Position, M1

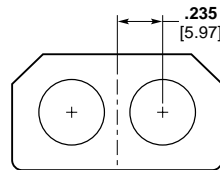

ARINC 404, 2 Position, M2

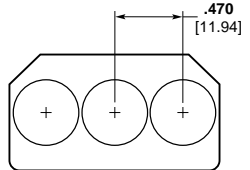

ARINC 404, 3 Position, M3

ARINC 404 Insert Holders for Jr. Expanded Beam Contacts

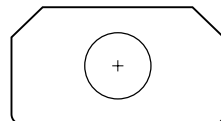

ARINC 404, 1 Position, J1

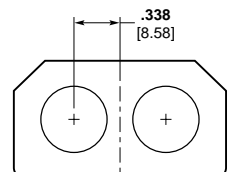

ARINC 404, 2 Position, J2

Inserts for Fiber Optic Connectors

Inserts available to accept AMP Mini-Expanded Beam Fiber Optic Cable Assemblies. Custom design configurations can be provided.

Contact Tyco Electronics for additional information, or see page 3011 in ARINC 600 section, and page 4014 and 4015 in Expanded Beam Fiber Optics section.

Modifications

Example: RME 2 P 57S 57S — 00 01 (201)

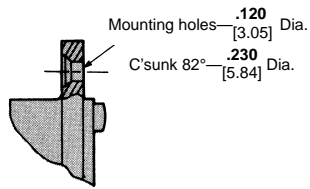

Modification 00
(no modification, plug)

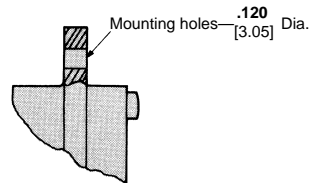

Modification 00
(no modification, receptacle)

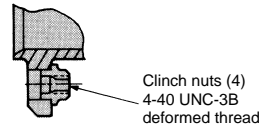

Modification 01

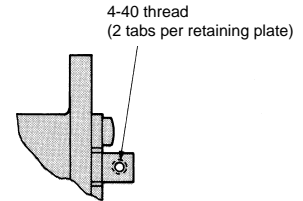

Modification 02
(R, RM, M, MM—attaching tabs)

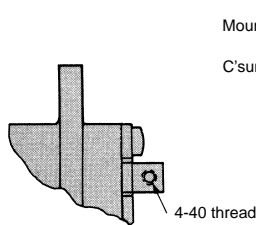

Modification 02, 70
(RME, MME—threaded holes)

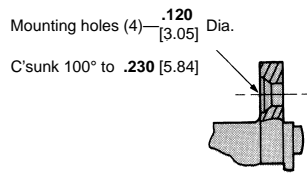

Modification 03

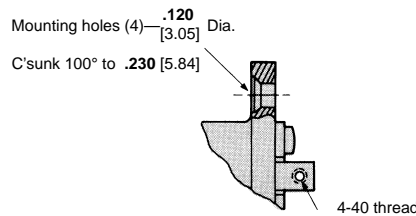

Modification 04
(R, RM, M, MM—attaching tabs)

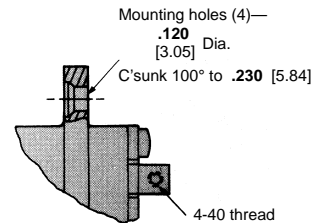

Modification 04
(RME, MME—threaded holes)

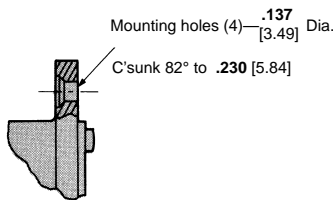

Modification 08

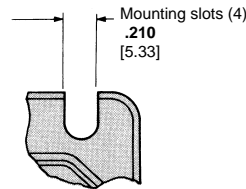

Modification 12

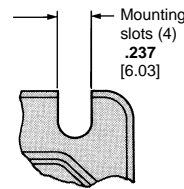

Modification 13

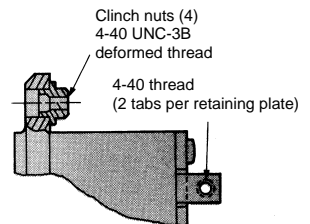

Modification 17
(R, RM, M, MM—attaching tabs)

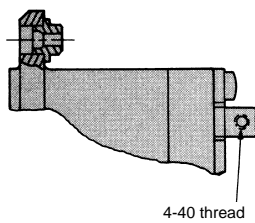

Modification 17
(RME, MME—threaded holes)

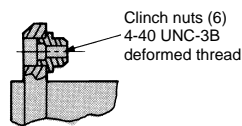

Modification 18

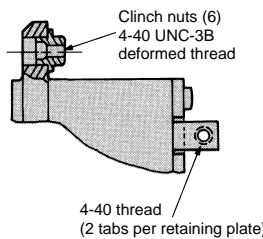

Modification 19
(R, RM, M, MM—attaching tabs)

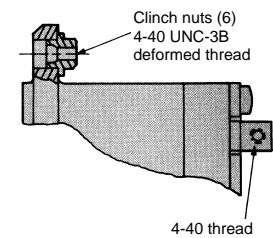

Modification 19
(RME, MME—threaded holes)

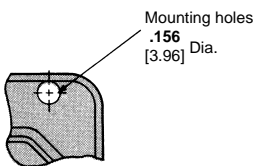

Modification 20

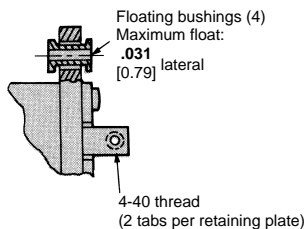

Modification 22
(R, RM, M, MM—attaching tabs)

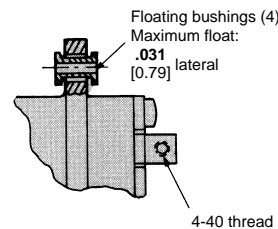

Modification 22, 71
(RME, MME—threaded holes)

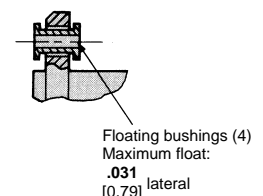

Modification 23, 39

Example: RME 2 P 57S 57S — 39 01 (201)

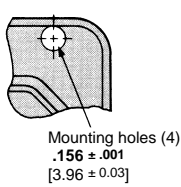

Modification 25

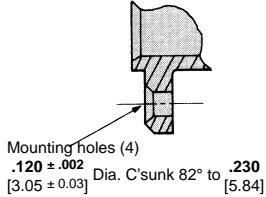

Modification 26

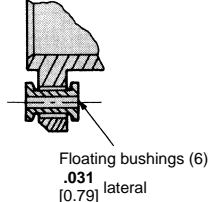

Modification 29

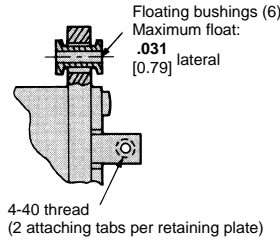

Modification 30
(R, RM, M, MM—attaching tabs)

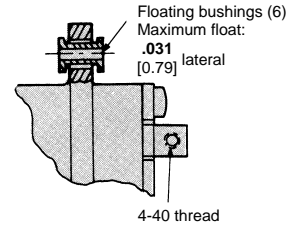

Modification 30
(RME, MME—threaded holes)

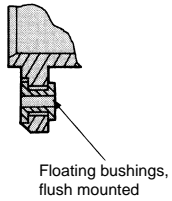

Modification 33

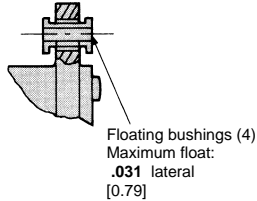

Modification 39

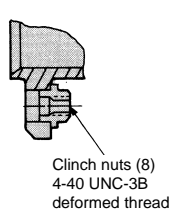

Modification 42
(4-Insert Shells)

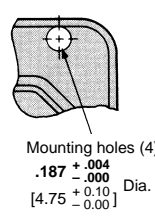

Modification 46

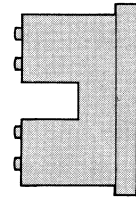

Jackscrews: Male in plug;
female in receptacle

Modification 50

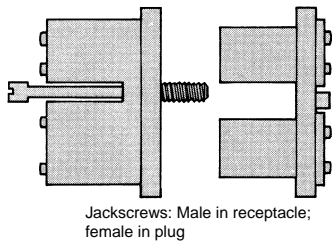

Jackscrews: Male in receptacle;
female in plug

Modification 51

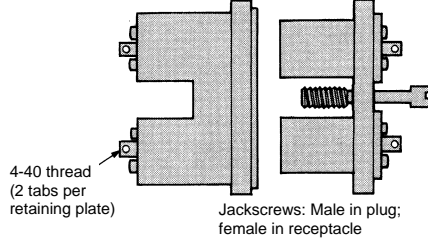

4-40 thread
(2 tabs per retaining plate)

Jackscrews: Male in plug;
female in receptacle

Modification 52
(R, RM, M, MM—attaching tabs)

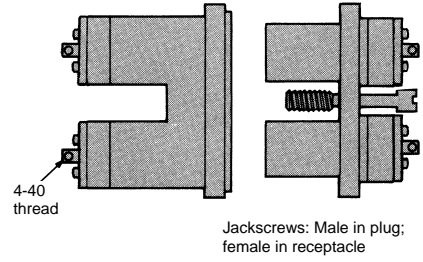

4-40
thread

Jackscrews: Male in plug;
female in receptacle

Modification 52
(RME, MME—threaded holes)

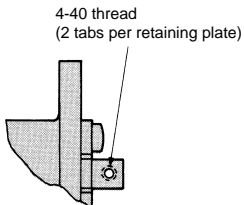

Modification 72
modification 46,
plus tabs above

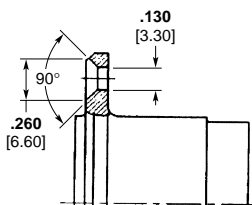

Modification 73 (without tabs)
Modification 74 (with tabs)
Size 1, 2, 3 shells — 4 c'sunk holes
Size 4 shells — 6 c'sunk holes

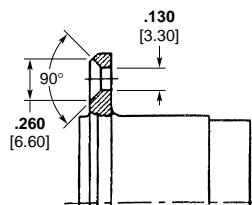

Modification 76

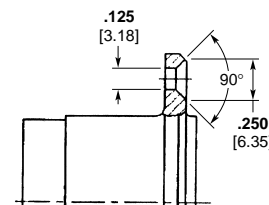

Modification 77

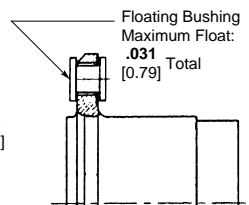

Modification 78

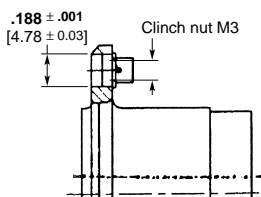

Modification 79

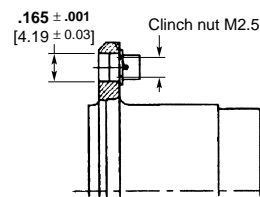

Modification 80

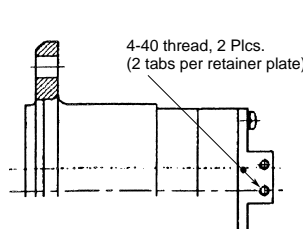

Modification 88

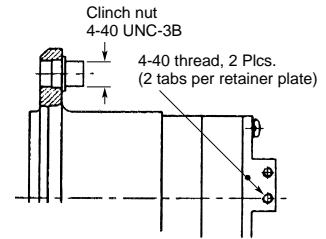

Modification 89

Keying

Example: RME 2 P 57 S 57 S — 00 01 (201)

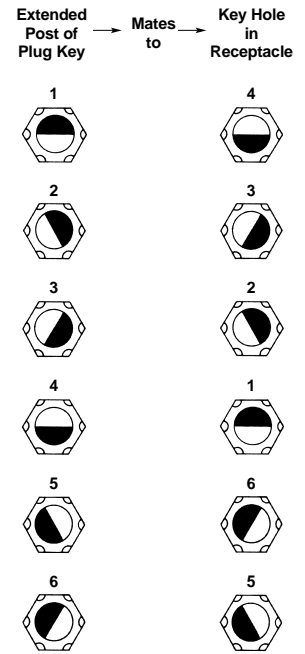
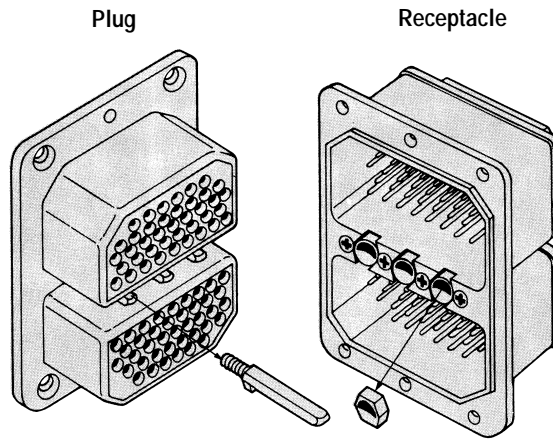

- Notes:**
1. Darkened portion of diagram indicates extended post of plug key, light portion indicates key hole in receptacle insert.
 2. Keying code stamped on housing.
 3. If keying code is not specified, key inserts are supplied in 01 position; code is not stamped on housing.
 4. If code 00 is specified, keys are omitted and must be ordered separately; code is not stamped on housing.
 5. Key diagrams show mating face of connector "TOP" up.

Refer to ARINC 600 pages 3012 and 3013 for keying codes.

Custom Order Code

Example: RME 2 P 57 S 57 S — 00 01 (201)

Code	Description
200	Standard connector kit, including signal contacts ; order coaxial contacts separately. See pages 3048 and 3049. Shell finish: cadmium plated per QQ-P-416 with yellow chromate conversion.
201	200 Custom Order Code without contacts , contacts must be ordered separately by part number. See pages 3045, 3046 and pages 3048, 3049.
202	201 Custom Order Code with assembled connector, keying unassembled and packaged in a separate container, contacts must be ordered separately by part number. See pages 3045, 3046 and pages 3048, 3049.
203	200 Custom Order Code with inserts and retainer plates unassembled.
204	200 Custom Order Code with spare contacts—3% of contact population per connector per contact size.
206	200 Custom Order Code with keying unassembled and packaged in a separate container.
250	200 Custom Order Code, except shell and retainer plates plated electroless nickel.
400	200 Custom Order Code, except contacts are low insertion force, ARINC 600.

Size 22 Contacts — Pin Diameter .030 [0.76]

Standard Contacts

Materials

Pin and Socket Body — Copper alloy, plated gold over nickel

Socket Sleeve — Passivated stainless steel

Application Tooling — See page 3047

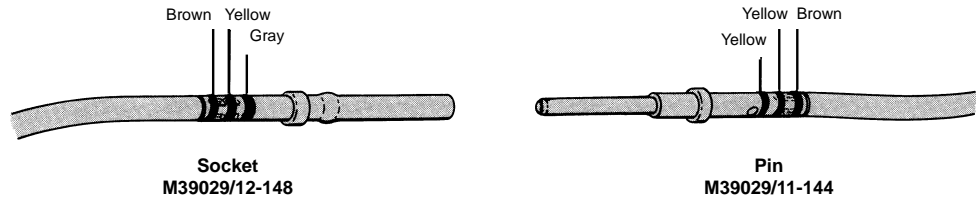

Contact Type	Wire Size AWG mm ²	Insulation Diameter (Max.)	Tape Mounted Contacts		Loose Piece Contacts		Hand Crimping Tool		AMP-TAPETRONIC Stripper-Crimper	
			Pin	Socket	Pin	Socket	Tool	Positioner	Machine	Funnel
MIL-C-39029	26-22 0.12-0.4	.054 1.37	204873-3	—	204873-4	205103-3	M22520/2-01	M22520/2-23	599406-7	1-125905-2

Low Force, ARINC 600 connector contacts, suitable for use in ARINC 404 connectors (see page 3016)

Low Force ARINC 600*	26-22 0.12-0.4	.054 1.37	—	—	208262-3	208264-2	M22520/2-01	M22520/2-23	—	—
----------------------	-------------------	--------------	---	---	----------	----------	-------------	-------------	---	---

*Color coding, two bands: orange and green.

Round Solder-Post Contacts, Solder Post Diameter .031 [0.79]

Note: Round solder-post contacts are for use in RM series connectors.

Materials

Pin and Socket Body — Copper alloy, plated gold over copper

Socket Sleeve — Passivated stainless steel

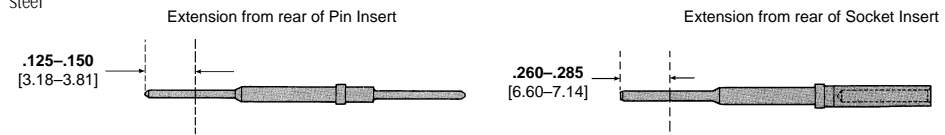

Round Solder-Post Pin
Part Number 205753-2 (Loose Piece)

Round Solder-Post Socket (Loose Piece)
Part Number 205544-1 — .031 [0.79] Dia. Tail
Part Number 205544-2 — .023 [0.58] Dia. Tail

Insertion and extraction tool for all ARINC 404 size 22 contacts:
MS81969/1-01
AMP Part Number 91066-1

Size 20 Contacts — Pin Diameter .040 [1.02]

Standard Contacts

Materials

Pin and Socket Body — Copper alloy, plated gold over nickel

Socket Sleeve — Passivated stainless steel

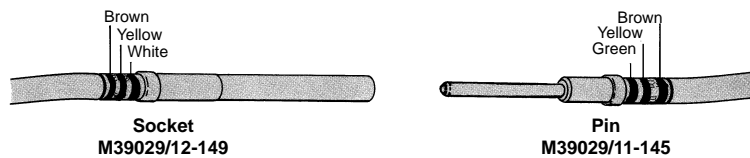

Contact Type	Wire Size AWG mm ²	Insulation Diameter (Max.)	Tape Mounted Contacts		Loose Piece Contacts		Hand Crimping Tool		AMP-TAPETRONIC Stripper-Crimper	
			Pin	Socket	Pin	Socket	Tool	Positioner	Machine	Funnel
MIL-C-39029	24-20 0.2-.06	.071 1.80	204938-4	205116-2	204938-3	205116-1	M22520/2-01	M22520/2-08	599406-7	125905-1
Type XVII	30-26 0.05-0.15	.071 1.80	205791-4	—	205791-3	206887-1	M22520/2-01	M22520/2-08	599406-7	2-125905-4

Low Force, ARINC 600 connector contacts, suitable for use in ARINC 404 connectors (see page 3016)

Low Force ARINC 600*	24-20 0.2-0.6	.071 1.80	208265-4	—	208265-3	208267-2	M22520/2-01	M22520/2-08	599406-7	125905-1
----------------------	------------------	--------------	----------	---	----------	----------	-------------	-------------	----------	----------

*Color coding, two bands: orange and red.

Round Solder-Post Contact, Solder Post Diameter .031 [0.79]

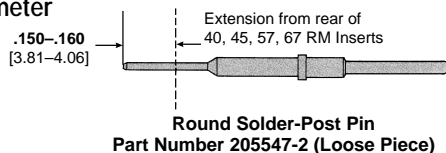

Round Solder-Post Pin
Part Number 205547-2 (Loose Piece)

Material — Copper alloy, plated gold over nickel

Wrap-Type Posted Pin, .025 [0.64] Square Post

A	Part Number
.430 10.92	206210-2
.685 17.4	206210-4
.185 4.7	206210-6

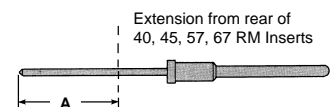

Insertion and Extraction Tool for all ARINC 404 size 20 contacts:
MS81969/1-02
AMP Part Number 91067-2

Size 16 Contacts — Pin Diameter .062 [1.58]

Standard Contacts

Materials

Pin and Socket Body — Copper alloy, plated gold over nickel

Socket Sleeve — Passivated stainless steel

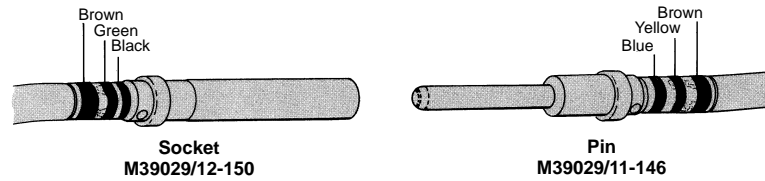

Contact Type	Wire Size AWG mm ²	Insulation Diameter (Max.)	Tape Mounted Contacts		Loose Piece Contacts		Hand Crimping Tool		AMP-TAPETRONIC Stripper-Crimper	
			Pin	Socket	Pin	Socket	Tool	Positioner	Machine	Funnel
MIL-C-39029	20-16 0.5-1.4	.103 2.62	—	205117-2	204978-3	205117-1	M22520/1-01	M22520/1-02	599406-5	125905-6

Low Force, ARINC 600 connector contacts, suitable for use in ARINC 404 connectors (see page 3016)

Low Force ARINC 600*	20-16 0.5-1.4	.103 2.62	—	—	208268-3	208270-2	M22520/1-01	M22520/1-02	—	—
----------------------	-------------------------	---------------------	---	---	----------	----------	-------------	-------------	---	---

*Color coding, two bands: orange and blue.

Round Solder-Post Contact Solder Post Diameter .062 [15.75]

Material — Copper alloy, plated gold over nickel

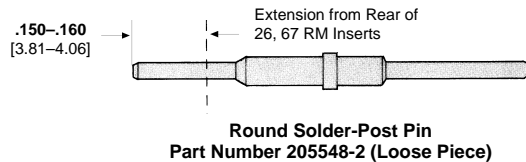

Round Solder-Post Pin
Part Number 205548-2 (Loose Piece)

Solder Cup Pin

Material — Copper alloy, plated gold over nickel

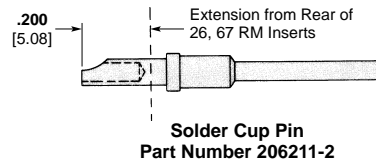

Solder Cup Pin
Part Number 206211-2

Insertion and Extraction Tool for all size 16 contacts: MS81969/1-03, AMP Part Number 91066-3

Size 12 Contacts — Pin Diameter .096 [2.39]

Materials

Pin and Socket Body — Copper alloy, plated gold over nickel

Socket Sleeve — Passivated stainless steel

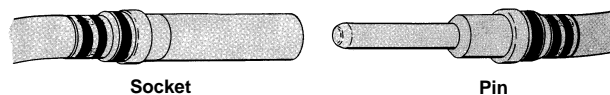

Contact Type	Wire Size AWG mm ²	Insulation Diameter (Max.)	Part Numbers			
			Loose Piece Contacts		Hand Crimping Tool	
			Pin	Socket	Tool	Positioner
MIL-C-39029	14-12 2-3	.190 4.83	205763-5	205851-2	M22520/1-01	M22520/1-11

Low Force, ARINC 600 connector contacts, suitable for use in ARINC 404 connectors (see page 3016)

Low Force ARINC 600*	14-12 2-3	.190 4.83	208271-3	208273-2	M22520/1-01	M22520/1-11
----------------------	---------------------	---------------------	----------	----------	-------------	-------------

*Color coding, two bands: orange and yellow.

Insertion and Extraction Tool for all size 12 contacts: AMP Part Number 445147-1

Application Tooling

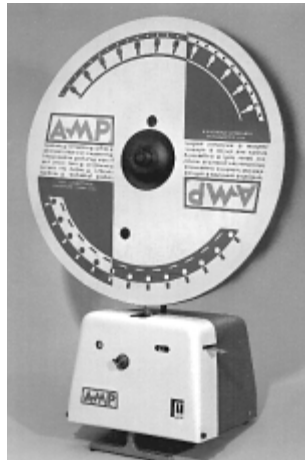

AMP-TAPEMATIC Stripper/Crimper
Machine Part Number 599406-7

Portable bench machine that strips wire and crimps tape-mounted, closed-barrel pin and socket contacts for AMPLIMITE Military, ARINC and CPC connectors. The stripping and crimping heads are accessible through separate openings in the front of the machine. Wire strip length and crimp height are adjustable. The stripping head is pre-set to the proper cutting depth of four standard wire sizes.

Specifications

- Width** — 12.5 [317]
- Depth** — 12.5 [317]
- Height** — 10 [254] without reel
- Weight** — 45 lb [20 kg]
- Electrical** — 120 VAC, 60 Hz, 1.3 A
- Wire Range** — 28-20 AWG [0.08-0.5 mm²]



Hand Crimping Tool
(AMP Tool Number 601966-1)
Part Number M22520/2-01

This standard military-type hand tool terminates screw-machined pins and sockets to wire with an 8-indent, M22520/2 crimp. It is ideally suited for prototype, field maintenance and other applications where volume production is not a factor.

Application Tooling Instruction Sheet Cross Reference

Tool Number	Instruction Sheet
601966-1	408-7516
601967-1	408-7516
599406-7	408-7516

Insertion/Extraction Tools, ARINC 404

Tool Part Number	Product Line	Contact Size	Contact Type	Color Code	Style
91066-1	ARINC 404	22	Signal	Green	Rear Release/Rear Remove
91067-2	ARINC 404	20	Signal	Red	Rear Release/Rear Remove
91066-3	ARINC 404	16	Signal	Blue	Rear Release/Rear Remove
445147-1	ARINC 404	12	Signal	—	Rear Release/Rear Remove
91066-3	ARINC 404	15	Coax	Blue	Rear Release/Rear Remove
91074-1	ARINC 404	9	Coax	—	Rear Release/Rear Remove
N/A captivated	ARINC 404	7	Coax	—	Rear Release/Rear Remove
91074-1	ARINC 404	5	Coax	—	Rear Release/Rear Remove
N/A captivated	ARINC 404	3	Coax	—	Rear Release/Rear Remove
N/A captivated	ARINC 404	1	Coax	—	Rear Release/Rear Remove

COAXICON Contacts

Size 1 Contacts

(For use in ARINC 404 and ARINC 600 Connectors)

Performance Characteristics

Nominal Impedance — 50 ohms

Frequency Range — 0 to 5 GHz

Operating Temperature —
-85°F to 329°F [-65°C to +165°C]

Operating Voltage (Rated) —
1000 VAC rms, 60 Hz at Sea Level

Contact Resistance (Milliohms) —
1.0 max. — Center Contact
0.2 max. — Outer Contact

Insulation Resistance — 5,000 megohms min. @500 vdc per MIL-STD-1344, Method 3003 or MIL-STD-202, Method 302, Cond. B

Dielectric Withstanding Voltage (60 Hz, rms) —

RG 214/U
2500 at Sea Level
RG 142/U
1900 at Sea Level

VSWR — 1.35 to 1.00 at 5 GHz

Insertion/Withdrawal Force —
Insertion (max.) 15 lb [66.72 N]
Withdrawal (min.) 1 lb [4.45 N]

Cable Retention —
RG 214/U
125 lb [556 N] min.
RG 142/U
60 lb [266.9 N] min.

Thermal Shock — per MIL-STD-1344, Method 1003, Cond. A or MIL-STD-202, Method 107, Cond. A

Physical Shock — per MIL-STD-1344, Method 2004, Cond. D or MIL-STD-202, Method 213, Cond. D except 300 G max.

Vibration — per MIL-STD-1344, Method 2005, Cond. VI, Letter J or MIL-STD-202, Method 204, Cond. E except 42 G max.

Humidity Temperature Cycling — per MIL-STD-1344, Method 1002, Type II, Cond. A or MIL-STD-202, Method 106

Salt Spray — per MIL-STD-1344, Method 1001, Cond. B or MIL-STD-202, Method 101, Cond. B

Temperature Life — per MIL-STD-1344, Method 1005, Cond. D or MIL-STD-202, Method 108, Cond. D

Material and Finish

Contact — Beryllium Copper per ASTM-B-196/ASTM-B-197, Brass per ASTM-B-16, TEFLON per ASTM-D-1710, Silicon Rubber per ZZ-R-765, Gold plate per MIL-G-45204, Nickel plate per QQ-N-290

Ferrule — Copper per ASTM-B-188, Tin plate per ASTM-B-545

Size 1 (Captivated)

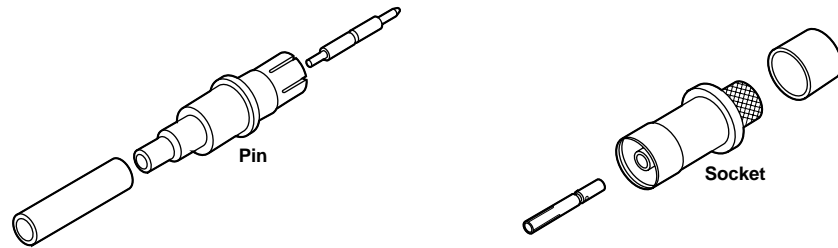

Contact Size	RG/U Cable	Contact Part No.		"O" Crimp Tooling			Compression Crimp Tooling		
		Pin	Socket	Tool (M22520/)	Center Contact Positioner/Die	Ferrule	Tool (M22520/)	Locator (M22520/)	Dies (M22520/)
1	402 Semi-Rigid .141 [3.58]	225837-1	—	601966-1 (2-01)	1-601966-9	91905-1*	—	—	—
	402 Semi-Rigid .141 [3.58]	222018-1	—	—	—	—	59980-1 (36-01)	220220-2 (36-06)	312253-1 (36-03)
	405 Semi-Rigid .086 [2.18]	222018-2	—	—	—	—	59980-1 (36-01)	220220-2 (36-06)	312253-2 (36-02)
	214	—	225831-1	220015-1	—	220015-1	—	—	—
	142, 142A, 142B	—	225831-3	91902-1*	—	91902-1*	—	—	—
	393	—	225831-6	220015-1	—	220015-1	—	—	—

* SDE die used with tool frame 354940-1

Size 3 Contacts

(For use in ARINC 404 Connectors)

Performance Characteristics

Nominal Impedance — 50 ohms

Frequency Range — 0 to 5 Ghz

Operating Temperature —
-85°F to 329°F [-65°C to +165°C]

Operating Voltage (Rated) —
500 V rms, 60 Hz at Sea Level

Contact Resistance (Milliohms) —
Center Contact — 2.1 max.
Outer Contact — 0.2 max.

Insulation Resistance —
5,000 megohms min. @ 500 vdc per
MIL-STD-1344, Method 3003 or MIL-
STD-202, Method 302, Cond. B

Dielectric Withstanding Voltage (60 Hz, rms) —
1500 V rms at Sea Level

VSWR — 1.3 to 1.0 at 5 Ghz

Material and Finish

Contact — Beryllium Copper per
ASTM-B-196/ASTM-B-197, Brass per
ASTM-B-16, TEFLON per ASTM-D-1710,
Silicon Rubber per ZZ-R-765, Gold plate
per MIL-G-45204, Nickel plate per
QQ-N-290, Tin plate per MIL-L-46064A

Ferrule — Copper per ASTM-B-188,
Tin plate per ASTM-B-545

Size 3 (Captivated)

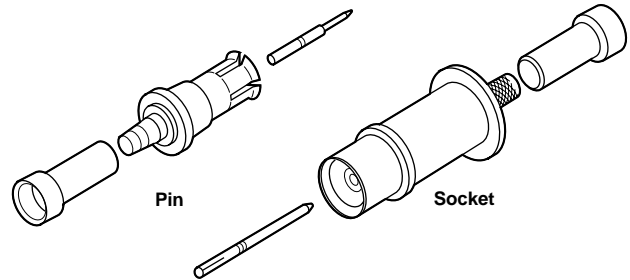

Contact Size	RG/U Cable	Contact Part No.		"O" Crimp Tooling		
		Pin	Socket	Center Contact	Positioner/ Die	Ferrule
3	58C	226053-1	225792-3	601966-1 (2-01)	2-601966-4 ¹ 1-601966-8 ²	91905-1*
	225	—	225792-5	220015-1	—	220015-1
	214	—	225792-1	220015-1	—	220015-1
3 (Right-Angle)	142, 142A, 142B	228011-1	—	601966-1 (2-01)	1-601966-8	91905-1*

¹Use with pin contact

²Use with socket contact

* SDE die used with tool frame 354940-1

Size 5, 9 and 15 Contacts

(For use in ARINC 404 Connectors)

Performance Characteristics for size 5, 9 and 15 contacts

Nominal Impedance — 50 ohms

Frequency Range — 0 to 500 MHz

Operating Temperature —
-85°F to 329°F [-65°C to +165°C]

Operating Voltage (Rated) —
325 VAC rms, 60 Hz

Contact Resistance (Milliohms) —
Sizes 5 and 9 with RG 58/U cable:
Center Contact — 10
Outer Contact — 1.5

Size 15 with RG 316/U cable:
Center Contact — 15
Outer Contact — 2

Insulation Resistance —
5,000 megohms min. @ 500 vdc per
MIL-STD-1344, Method 3003 or MIL-
STD-202, Method 302, Cond. B

Dielectric Withstanding Voltage (60 Hz, rms) —

Sizes 5 and 9 with RG 58/U and 316/U cable:

750 - Sea Level
350 - 50,000 ft [15 240 m]

Size 15 with RG 316/U, 178/U and 196/U cable:

325 - Sea Level
150 - 50,000 ft [15 240 m]

VSWR — 1.3 to 1.0 @ 500 MHz

Insertion/Withdrawal Force —
Sizes 5 and 9:

Insertion Force Maximum		Withdrawal Force Minimum	
lb	[N]	lb	[N]
5	22.24	1	4.45

Size 15:

Insertion Force Maximum		Withdrawal Force Minimum	
oz	[N]	oz	[N]
35	6.95	5	1.39

Cable Retention —

Sizes 5 and 9:
60 lb [266.9 N]

Size 15:
10 lb [44.5 N]

Durability — 500 cycles

Thermal Shock — per MIL-STD-1344,
Method 1003, Cond. A or MIL-STD-202,
Method 107, Cond. A

Physical Shock — per MIL-STD-
1344, Method 2004, Cond. A or MIL-
STD-202, Method 213, Cond. A

Vibration — per MIL-STD-1344,
Method 2005, Cond. IV or MIL-STD-
202, Method 204, Cond. D

Moisture Resistance — per MIL-
STD-202, Method 106, omit steps 7a
and 7b

Salt Spray — 48 hours per MIL-STD-
1344, Method 1001, Cond. B or MIL-
STD-202, Method 101, Cond. B

Material and Finish

Contact — Beryllium copper per
ASTM-B-196/ASTM-B-197, Brass per
ASTM-B-16, TEFLON per ASTM-D-
1710, Gold plate per MIL-G-45204,
Nickel plate per QQ-N-290

Ferrule — Copper per ASTM-B-188,
tin plate per ASTM-B-545

Size 5

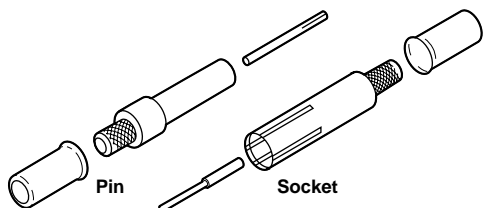

Size 9

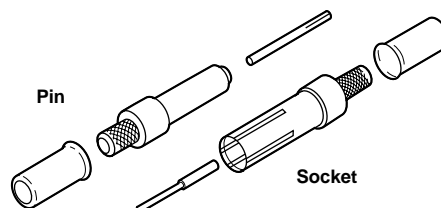

Size 15

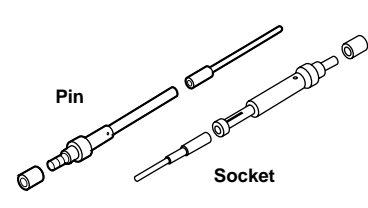

Size 5, 9 and 15 Contacts

(Continued)

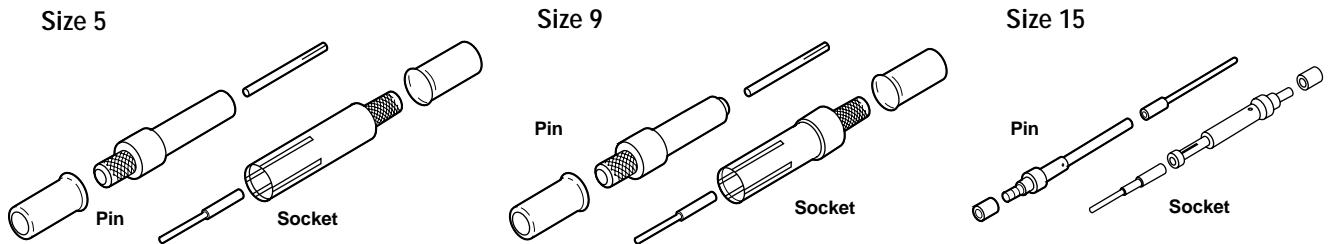

Contact Size	RG/U Cable	Contact Part No.		"O" Crimp Tooling			Military Hex Crimp Tooling			
				Center Contact			Center Contact		Ferrule	
				Pin	Socket	Tool (M22520)	Positioner/Die	Ferrule	Tool (M22520)	Die (M22520)
5	58C	225790-1	225791-1	601966-1 (2-01)	1-601966-6 K345	91905-1*	—	—	—	—
	400, 142, 142A, 142B	225790-2	225791-2	220066-2	—	91905-1*	—	—	—	—
	141A	225790-1	225791-1	220066-2	—	91905-1*	—	—	—	—
	402 Semi-Rigid .141 [3.58]	225790-3	225791-6	220066-2	—	91905-1*	—	—	—	—
	174, 188, 316	225790-5	225791-3	601966-1 (2-01)	1-601966-6 K345	91905-1*	—	—	—	—
	180, 195	225790-4	225791-8	601966-1 (2-01)	1-601966-6 K345	91905-1*	—	—	—	—
	179, 187	225790-6	225791-4	601966-1 (2-01)	1-601966-6 K345	91905-1*	—	—	—	—
	178, 196	225790-7	225791-5	601966-1 (2-01)	1-601966-6 K345	220020-1	—	—	—	—
	223	225790-2	225791-2	601966-1 (2-01)	1-601966-6 K345	91905-1*	—	—	—	—
	316 Double Shield 188 Double Shield	225790-8	1-225791-0	—	—	—	601966-1 (2-01)	1-601966-6 K345	608650-1 (5-01)	(Y159)
Military Hex Crimp 5	316 Double Shield 188 Double Shield	225790-8	1-225791-0	—	—	—	601966-1 (2-01)	1-601966-6 K345	608650-1 (5-01)	(Y159)
	58C, 141A	447850-1	447851-1	—	—	—	601966-1 (2-01)	1-601966-6 K345	608650-1 (5-01)	(5-45B)
	142, 142A, 142B	447850-2	447851-2	—	—	—	601966-1 (2-01)	1-601966-6 K345	608650-1 (5-01)	(5-45B)
	402 Semi-Rigid .141 [3.58]	447850-3	447851-3	—	—	—	601966-1 (2-01)	1-601966-6 K345	608650-1 (5-01)	(5-45A)
	174, 188, 316	447850-4	447851-4	—	—	—	601966-1 (2-01)	1-601966-6 K345	608650-1 (5-01)	(5-37B)
9	58C 141A	225935-1	225936-2	601966-1 (2-01)	1-601966-6 K345	91905-1*	—	—	—	—
	174, 188 316	225935-4	225936-3	601966-1 (2-01)	1-601966-6 K345	91905-1*	—	—	—	—
	142A, 142B	225935-5	225936-5	601966-1 (2-01)	1-601966-6 K345	91905-1*	—	—	—	—
	316 Double Shield 188 Double Shield	225935-6	225936-9	—	—	—	601966-1 (2-01)	1-601966-6 K345	608650-1 (5-01)	(Y159)
	179, 187	225935-7	225936-7	601966-1 (2-01)	1-601966-6 K345	91905-1*	—	—	—	—
	188, 316	226782-1	226781-1	601966-1 (2-01)	2-601966-6	601963-2 (4-01)	—	—	—	—
15	179, 187	226782-2	226781-2	601966-1 (2-01)	2-601966-6	601963-2 (4-01)	—	—	—	—
	178, 196	226782-3	226781-3	601966-1 (2-01)	2-601966-6	601963-2 (4-01)	—	—	—	—

* SDE die used with tool frame 354940-1

Extraction tools:

Size 5 and 9 —
AMP Part Number 91074-1
Size 15 —
AMP Part Number 91066-3

Sealing Plugs

Size 22
Part Number 204760-1
White TEFLON



Size 20
Part Number 203839-1
Red thermoplastic



Size 16
Part Number 203839-2
Blue thermoplastic



Size 12
Part Number 205574-1
Yellow thermoplastic



Coaxial Sealing Plug and Boot

Size 5
Plug—Part Number 205975-1

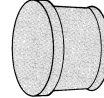

Boot for RG-58C cable—
Part Number 205402-2
Boot for RG-180, -190 cable—
Part Number 205402-3

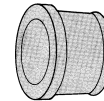

Dust Covers

Conductive Receptacle Cap
Part Number 445918-1
Conductive Plug Cap
Part Number 447162-1

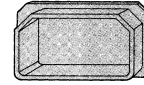

Plug Cap
Part Number 205282-1

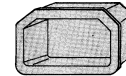

Receptacle Cap
Part Number 205283-1

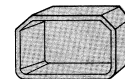

106-Contact Inserts for Flexible Flat Cable

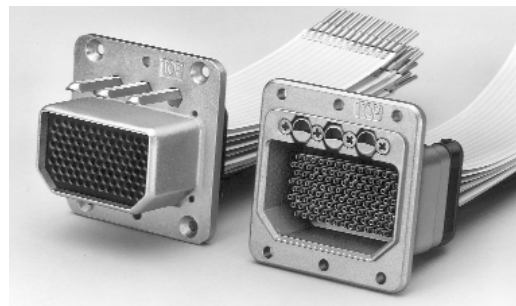

These custom-made assemblies use AMP Flexible Flat Conductor Cable which has .050 [1.27] wide conductors, .003 [0.08] thick, on .100 [2.54] centers (or similar, customer-specified cable). The inserts mate

with 106-contact inserts, shown on page 3041, with size 22 contacts.

The adaptability of flexible flat cable to many uses, the wide variety of contact styles available, and the high quality of AMP assembled har-

nesses make these inserts particularly attractive. Among their outstanding features are that they require no soldering, welding or potting, and the inserts are repairable by replacement of individual cables.

Flexible Flat Conductor Cable

■ Recognized under the Component Program of Underwriters Laboratories Inc., File No. E53793



Consult Tyco Electronics for additional information.

Specifications

- Temperature Rating** — -67°F to 221°F [-55°C to +105°C]
- Voltage Rating** — 300 volts per UL Style No. 2646
- Current Rating** — 3 amperes, equivalent 27 AWG [0.1 mm²]
- Insulation Resistance** — 5000 megohms (min.)
- Insulation Material** — Polyester
- Flammability** — Self-extinguishing per applicable UL requirement

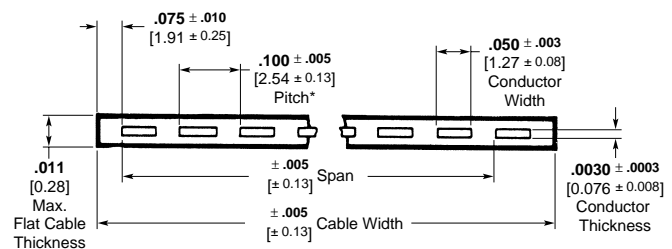

*Tolerance non-cumulative

Flexible Flat Cable Applications

Design Options

Some of the many possible applications for flexible flat cable are illustrated here. Additionally, individual cables can be divided for termination with a mixture of various contact styles. For more information consult Tyco Electronics.

- A** Receptacle contacts
- B** Double row receptacle housing
- C** .025 [0.64] square post, double-row, right-angle header
- D** .025 [0.64] square post, double-row, right-angle header, shrouded
- E** PC edge connector contacts
- F** PC edge connector housing
- G** Receptacle housing
- H** .025 [0.64] square post, single-row, right-angle header, shrouded
- J** .025 [0.64] square post, single-row, right-angle header
- K** .025 [0.64] square post, single-row, straight header
- L** .025 [0.64] square post, single-row, straight header, shrouded
- M** Polarized SIP Socket
- N** Solder tab housing
- P** Solder tab contacts

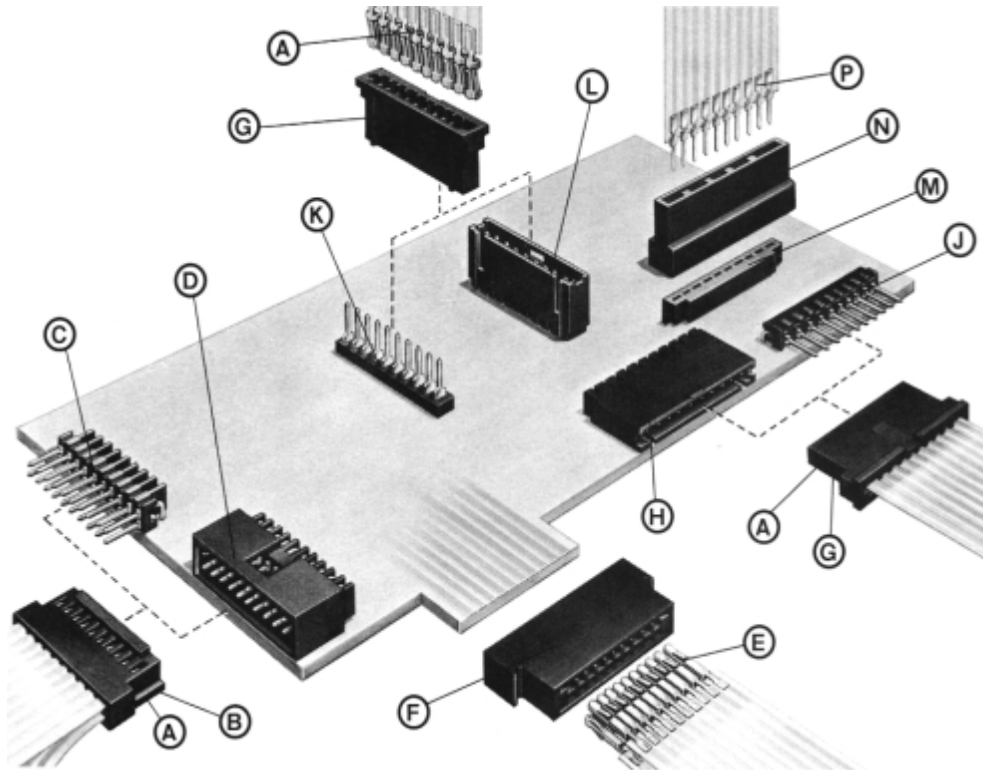

Multiple-Crimp Contacts

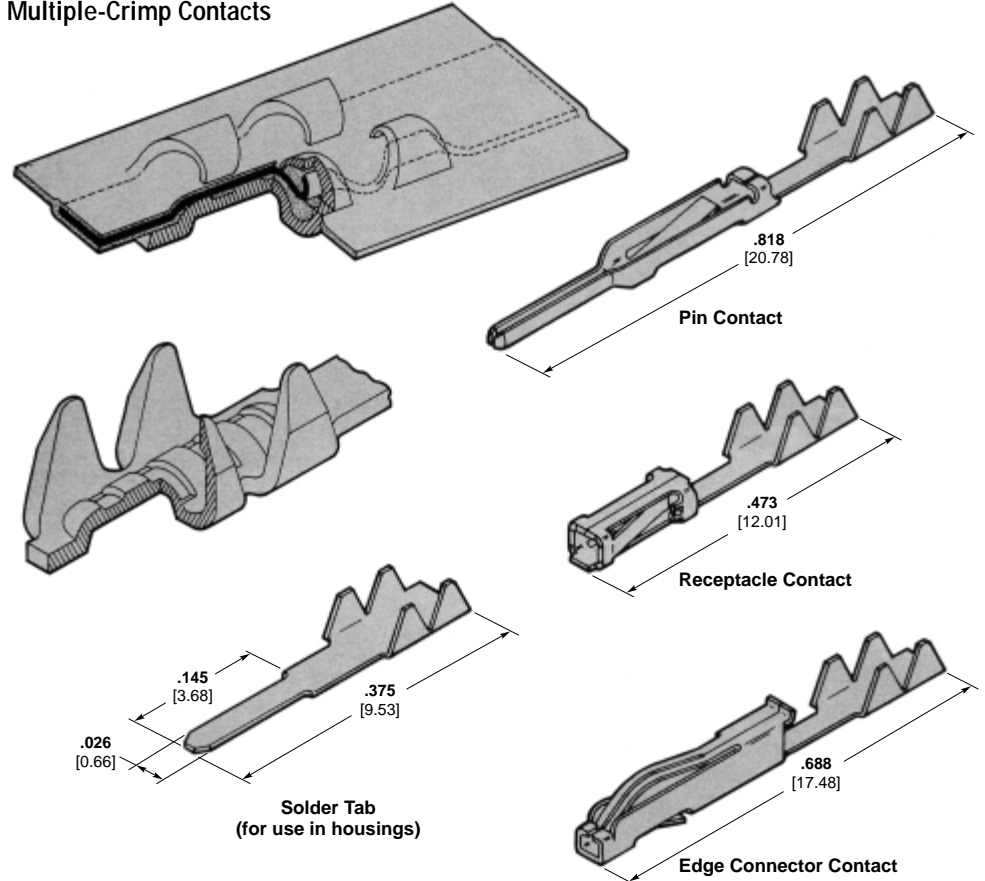

Miniature Connectors

RA Series (unsealed)

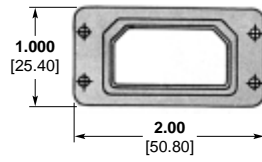
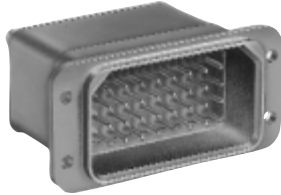

Plug (RA1P)

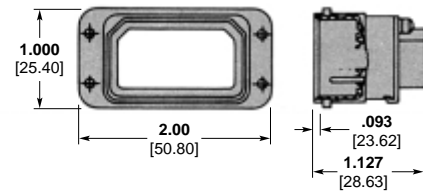

Receptacle (RA1R)

RE Series (environmentally sealed)

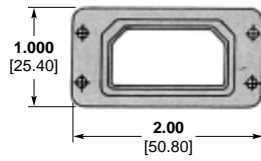

Plug (RE1P)

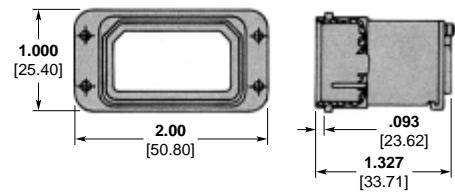

Receptacle (RE1R)

Contact Inserts for Miniature Connectors

These inserts accept standard contacts shown on pages 3045 and 3046.

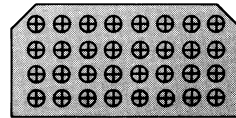

Arrangement 32
32 Size 20 Contacts

Standard Size, Unkeyed Connectors

RMA Series (unsealed)

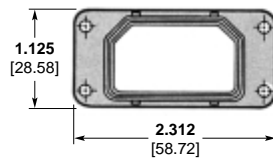

Plug

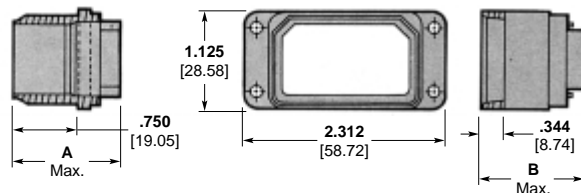

Receptacle

RMAE Series (environmentally sealed)

These connectors use inserts shown on page 3041. The shells are similar to standard series shells, except they are lighter weight and offer no keying provision.

Contact Arrangement	Dimensions			
	A Max. (Plug)		B Max. (Receptacle)	
	RMA	RMAE	RMA	RMAE
106	1.120 28.45	1.320 33.53	1.250 31.75	1.450 36.83
8, D8, 26, 40, 45, 57, 67	1.220 30.99	1.420 36.07	1.350 34.29	1.550 39.40
C8, 32C2, 32C4, 33C4, 40C1	1.420 36.07	1.420 36.07	1.550 39.37	1.550 39.37

Cross Reference

Descriptive Part No.	AMP Part No.	Descriptive Part No.	AMP Part No.
M2P106P106P-2300(204)	0-1218229-1	RM1P8S-0301(200)	0-1218237-1
M2R57P57P-0004(201)	0-1218368-1	RM1PD8P-0001(200)	0-0213435-1
M2RC8P106S-0104(200)	0-1218919-1	RM1R106S-01(200)	0-1218724-1
MM2R106S106S-0100(201)	0-1218476-1	RM1R32C4P-0101(200)	0-1218039-1
MME1P106P-2301(204)	0-1484157-1	RM1R33C4P-0001(201)	0-0213436-2
MME1P40S-0300(201)	0-1218230-1	RM1R33C4P-0101(200)	0-1218040-1
MME1P57P-2301(204)	0-1218638-1	RM1R33C4P-0101(201)	0-1218040-2
MME1R106S-0001(204)	0-1484158-1	RM1R40C1S-2301(200)	0-0213436-3
MME1R57S-0001(204)	0-1218639-1	RM1R40P-0301(201)	0-1218363-1
MME2P106PC8S-7101(201)	0-1218239-1	RM1R67P-00(200)	0-0213436-4
MME2P33C4S106P-29(204)	0-1218735-1	RM1R67P-0101(200)	0-1218041-1
MME2P33C4SD8S-00(200)	0-1218720-1	RM1R67P-0101(201)	0-1218041-2
MME2P57P57P-00(204)	0-1218814-1	RM1R67P-1848(200)*	0-1218656-1
MME2P57S57S-00(201)	0-1218706-1	RM1RD8S-0001(200)	0-0213436-1
MME2R33C4P106S-00(204)	0-1218745-1	RM2P106P106P-00(200)	0-0213437-9
MME2R33C4PD8P-00(200)	0-1218619-2	RM2P106P106P-00(201)	1-0213437-0
MME2R33C4PD8P-00(201)	0-1218619-1	RM2P106P106P-0000(201)	0-0445564-4
MME2R40P40P-0001(204)	0-1218236-1	RM2P106P106P-00(202)	4-0445564-0
MME2R57S57S-00(200)	0-1484033-1	RM2P106P106P-0401(201)	1-0445564-4
MME2R57S57S-00(201)	0-1484033-2	RM2P106S106S-0201(200)	3-0445564-6
MME3R26P26P26P-1801(200)	0-1218155-1	RM2P26PC8P-0001(200)	0-0213437-1
R1P106S-2301(201)	0-0213431-1	RM2P26S26S-0001(200)	0-0213437-2
R1P8S-0201(200)	0-1218133-1	RM2P26S26S-2301(201)	0-1218046-1
R1R106P-0001(201)	0-0213432-1	RM2P32C2P32C2P-0000(201)	0-0445564-0
R1R57P-0101(250)	0-1484148-1	RM2R32C2P40C1P-0001(200)	0-1218145-1
R2P26S33C4S-0001(200)	0-1218637-1	RM2P32C2S26S-0031(200)	0-1218876-1
R2P57S26S-0301(200)	0-1218361-1	RM2P33C4S33C4S-0001(200)	0-1218528-1
R2P57S57S-0001(200)	0-0213433-1	RM2P33C4S33C4S-0301(200)	0-0213437-4
R2P67S106P-3300(202)	2-0445564-0	RM2P33C4SC8S-0001(201)	0-0213437-3
R2P67S67S-0000(400)	0-1218101-1	RM2P33C4SD8S-0301(200)	0-1218228-1
R2R106S106S-0104(201)	0-0443098-1	RM2P40C1P40C1P-0000(201)	0-0445564-1
R2R106S106S-2301(200)	0-0213434-6	RM2P40S40S-02(206)	2-0445564-6
R2R106S106S-2301(201)	0-0213434-7	RM2P40S67S-0301(200)	0-1218226-1
R2R26P45P-0101(200)	0-0213434-1	RM2P45S45S-0001(200)	2-0445564-4
R2R32C4P106S-0101(201)	0-1218404-1	RM2P45S57S-00(200)	0-0206442-1
R2R45P45P-0101(200)	0-0213434-2	RM2P57P57P-0000(201)	0-0445564-2
R2R57P26P-0301(201)	0-1218205-1	RM2P57S57S-00(200)	0-0213437-5
R2R57P57P-0001(201)	0-1218146-1	RM2P67P67P-0000(201)	0-0445564-3
R2R67P67P-0001(200)	0-0213434-3	RM2P67S32C2S-0001(200)	0-0213437-6
R2R67P67P-0001(201)	0-0213434-4	RM2P67S32C2S-0001(201)	0-0213437-7
R2R67P67P-0101(200)	0-0213434-5	RM2P67S67S-00(202)	4-0445564-1
RA1R32P-00(201)	0-1218080-1	RM2P67S67S-0301(200)	0-0213437-8
RE1P32S-00(200)	0-1218176-1	RM1P67S67S-5001(200)	0-1218045-1
RM1P106P-00(202)	0-1218314-1	RM2PC8SC8S-0301(201)	1-0445564-7
RM1P26S-0001(200)	0-0213435-2	RM2R106P106P-0001(201)	1-0213438-3
RM1P33C4S-0001(201)	0-0213435-3	RM2R106S106S-00(200)	1-0213438-4
RM1P33C4S-0001(200)	0-1218182-1	RM2R106S106S-00(202)	0-0446913-9
RM1P40C1P-0001(200)	0-0213435-5	RM2R106S106S-0101(201)	0-1218934-1
RM1P40C1S-0001(200)	0-0213435-6	RM2R106SD8P-0001(200)	1-0213438-2
RM1P40S-0001(201)	0-0213435-4	RM2R26P26P-0001(200)	0-0213438-2
RM1P40S-0001(200)	0-1218350-1	RM2R26SC8S-0001(200)	0-0213438-1
RM1P45S-00(200)	0-1218479-2	RM2R32C2P40C1P-0001(201)	0-0213438-3
RM1P45S-0000(200)	0-1218479-1	RM2R33C4P33C4P-0101(200)	0-1218490-1
RM1P57S-00(200)	0-0213435-7	RM2R33C4P33C4P-2301(200)	0-0213438-6
RM1P57S-00(201)	0-0213435-8	RM2R33C4P57P-0101(400)	0-1218299-1
RM1P57S-0001(200)	0-1218401-1	RM2R33C4S33C4S-0001(200)	0-0213438-5
RM1P67S-00(200)	0-0213435-9	RM2R33C4SC8S-0001(201)	0-0213438-4
RM1P67S-0001(200)	0-1218042-1	RM2R40C1P67P-00(200)*	0-1218473-1
RM1P67S-2366(200)	0-1218756-1	RM2R40P40P-0104(200)	0-1218342-1

*Assembly loaded with posted contacts

Cross Reference (Continued)

Descriptive Part No.	AMP Part No.
RM2R40P67P-3301(200)	0-1218227-1
RM2R57P57P-0104(200)	0-1218348-1
RM2R67P26P-00(200)	0-0213438-7
RM2R67P32C2P-0001(200)	0-0213438-8
RM2R67P40C1P-0101(200)	0-0213438-9
RM2R67P57P-00(200)	1-0213438-0
RM2R67P67P-0000(200)	0-0446913-0
RM2R67P67P-00(202)	2-0445564-2
RM2R67P67P-0101(200)	1-0213438-1
RM2RC3P67P-0019(201)	0-1218206-1
RM2R67P32C2P-0101(200)	0-0448584-1
RM3P32C2S67S32C2S-0001(201)	0-1218349-1
RM3P40S32C2SC2S-0301(200)	0-1218224-1
RM3PC8S32C2S106P-0001(200)	0-0443969-1
RM3R40P32C2PC2P-3301(200)	0-1218225-1
RM2R40P40P-0104(200)	0-1218342-1
RM3RC8P32C2P106S-0001(200)*	0-0443970-1
RM4P106P106P106P88P-00(200)	0-0443174-1
RM4R88S106S106S106S-00(200)*	0-0443089-1
RMA1P26P-00(201)	0-1218202-1
RMA1P26S-00(201)	0-1218201-1
RMA1P45S-39(201)	0-1218959-1
RMA1P8S-39(201)	0-1218957-1
RMA1R26P00(201)	0-1218203-1
RMA1R45P-01(201)	0-1218960-1
RMA1R8P-01(201)	0-1218958-1
RME1P106P-0301(201)	0-1218354-1
RME1P33C4S-0001(200)	0-0213439-1
RME1P40C1S-01(250)	0-1484241-1
RME1P40C1S-01(251)	0-1484241-2
RME1P40S-0101(200)	0-1218352-1
RME1R106S-0201(201)	0-1218402-1
RME1R33C4P-0001(200)	0-0213440-2
RME1R40C1P-01(250)	0-1484240-1
RME1R40C1P-01(251)	0-1484240-2
RME1R40P-0001(200)	0-0213440-3
RME1R8P-0101(200)	0-0213440-1
RME2P106P106P-00(201)	0-0213441-6
RME2P106P106P-0001(200)	0-0213441-5

Descriptive Part No.	AMP Part No.
RME2P106P106P-0301(200)	0-0213441-7
RME2P106P106P-0399(254)	2-0445564-3
RME2P106P26P-0001(201)	1-0445564-3
RME2P106PD8S-5101(200)	2-0445564-1
RME2P106S106S-0001(200)	0-0213441-8
RME2P106S26P-0001(201)	1-0445564-5
RME2P106S26P-5001(201)	0-1218207-1
RME2P33C4S57S-0001(400)	0-1218300-1
RME2P40S40S-0015(200)	0-1218356-1
RME2P45S45S-0001(200)	0-0445564-5
RME2P45S8P-29 (204)	0-1218895-1
RME2P67S67S-0001(200)	0-0213441-2
RME2P67S67S-0101(200)	0-0213441-3
RME2P67S67S-0301(200)	0-0213441-4
RME2P67S67S-5001(200)	0-1218214-1
RME2P67SD8S-0001(200)	0-0213441-1
RME2P67SD8S-0001(201)	2-0445564-7
RME2P77C2P77C2P-0001(250)	0-0448235-1
RME2P8S77C2P-0001(250)	0-0448235-2
RME2PC8SC8S-0301(251)	0-0445564-6
RME2R106P106P-0001(201)	0-0446913-3
RME2R106P26S-2301(200)	0-0446913-1
RME2R106S106S-0001(201)	0-0446913-4
RME2R106S106S-2301(201)	0-0213442-5
RME2R106S33C4P-0001(201)	0-0213442-3
RME2R40P8P-0101(201)	0-0213442-1
RME2R45P8S-00(200)	0-1218894-1
RME2R67P26P-5002(200)	0-1484014-1
RME2R67P67P-3301(201)	0-1218343-1
RME2R67PD8P-0001(200)	0-0213442-2
RME2R77C2S77C2S-0001(250)	0-0448227-1
RME2R8P77C2S-0001(250)	0-0448227-2
RME2RC8S67S-00(200)	0-1218353-1
RME3P106P106P106S-0001(200)	0-1218297-1
RME3P57P26P26P-2600(201)	0-1218159-1
RME3P88S106S106S-0001(400)	0-1218358-1
RME3R57S26S26S-3300(201)	0-1218158-1
RME3R67P106S67P-7611(204)	0-1218723-1

*Assembly loaded with posted contacts

Military Cross Reference

The military connectors listed include contacts in quantities as specified by MIL-C-81659. Military connectors may be ordered without contacts by placing the (201) custom ordering code (page 3044) behind the AMP Descriptive Part Number. Military connectors with keying installed may also be ordered by specifying it in the AMP Descriptive Part Number (page 3038) or by placing the keying position directly behind the MIL-C-81659 part number.

In all cases described above, the MIL-C-81659 part number will be ink stamped on the connector shell, including keying if specified.

Note: To order commercial equivalent of QPL connectors, change the initial M of the AMP Designation in column 2 to an R; see page 3044 for keying code and custom order code, required to complete commercial designation.

Government Designation	AMP Designation	ITT Cannon Designation
MIL-C-81659/29A2-0001	MME1P26P-00	
MIL-C-81659/29A2-0002	MME1P26S-00	DPXBNE-26M-33S-00
MIL-C-81659/29A2-0009	MME1P40P-00	
MIL-C-81659/29A2-0010	MME1P40S-00	DPXBNE-40M-33S-00
MIL-C-81659/29A2-0017	MME1P45P-00	
MIL-C-81659/29A2-0018	MME1P45S-00	DPXBNE-45M-33S-00
MIL-C-81659/29A2-0025	MME1P57P-00	
MIL-C-81659/29A2-0026	MME1P57S-00	DPXBNE-57M-33S-00
MIL-C-81659/29A2-0033	MME1P67P-00	
MIL-C-81659/29A2-0034	MME1P67S-00	DPXBNE-67M-33S-00
MIL-C-81659/29A2-0041	MME1P106P-00	DPXBNE-A106-33P-00
MIL-C-81659/29A2-0042	MME1P106S-00	
MIL-C-81659/29A2-0083	MME1PD8P-00	
MIL-C-81659/29A2-0084	MME1PD8S-00	DPXBNE-D8M-33S-00
MIL-C-81659/31A2-0001	MME1R26P-00	DPXBNE-26M-34P-00
MIL-C-81659/31A2-0002	MME1R26S-00	
MIL-C-81659/31A2-0009	MME1R40P-00	DPXBNE-40M-34P-00
MIL-C-81659/31A2-0010	MME1R40S-00	
MIL-C-81659/31A2-0017	MME1R45P-00	DPXBNE-45M-34P-00
MIL-C-81659/31A2-0018	MME1R45S-00	
MIL-C-81659/31A2-0025	MME1R57P-00	DPXBNE-57M-34P-00
MIL-C-81659/31A2-0026	MME1R57S-00	
MIL-C-81659/31A2-0033	MME1R67P-00	DPXBNE-67M-34P-00
MIL-C-81659/31A2-0034	MME1R67S-00	
MIL-C-81659/31A2-0041	MME1R106P-00	
MIL-C-81659/31A2-0042	MME1R106S-00	DPXBNE-A106-34S-00
MIL-C-81659/31A2-0083	MME1RD8P-00	DPXBNE-D8M-34P-00
MIL-C-81659/31A2-0084	MME1RD8S-00	
MIL-C-81659/33A2-0003	MME2P26P26P-00	
MIL-C-81659/33A2-0004	MME2P26S26S-00	DPX2NE-26MS26MS-33B-00
MIL-C-81659/33A2-0011	MME2P40P40P-00	
MIL-C-81659/33A2-0012	MME2P40S40S-00	DPX2NE-40MD40MD-33B-00
MIL-C-81659/33A2-0019	MME2P45P45P-00	
MIL-C-81659/33A2-0020	MME2P45S45S-00	DPX2NE-45MS45MS-33B-00
MIL-C-81659/33A2-0027	MME2P57P57P-00	
MIL-C-81659/33A2-0028	MME2P57S57S-00	DPX2NE-57MS57MS-33B-00
MIL-C-81659/33A2-0035	MME2P67P67P-00	
MIL-C-81659/33A2-0036	MME2P67S67S-00	DPX2NE-67MS67MS-33B-00
MIL-C-81659/33A2-0043	MME2P106P106P-00	DPX2NE-A106PA106P-33B-00
MIL-C-81659/33A2-0044	MME2P106S106S-00	
MIL-C-81659/33A2-0057	MME2P106S26P-00	
MIL-C-81659/33A2-0058	MME2P106P26S-00	DPX2NE-A106P26MS-33B-00
MIL-C-81659/33A2-0059	MME2P26P106S-00	
MIL-C-81659/33A2-0060	MME2P26S106P-00	DPX2NE-26MSA106P-33B-00
MIL-C-81659/33A2-0071	MME2P67P106S-00	
MIL-C-81659/33A2-0072	MME2P67S106P-00	DPX2NE-67MSA106P-33B-00
MIL-C-81659/33A2-0089	MME2P106S67P-00	
MIL-C-81659/33A2-0090	MME2P106P67S-00	DPX2NE-A106P67MS-33B-00
MIL-C-81659/33A2-0133	MME2P57P106S-00	DPX2NE-57MSA106P-33B-00
MIL-C-81659/33A2-0134	MME2P57S106P-00	
MIL-C-81659/33A2-0147	MME2P57P26P-00	
MIL-C-81659/33A2-0148	MME2P57S26S-00	DPX2NE-57MS26MS
MIL-C-81659/35A2-0003	MME2R26P26P-00	DPX2NE-26MP26MP-34B-00
MIL-C-81659/35A2-0004	MME2R26S26S-00	
MIL-C-81659/35A2-0011	MME2R40P40P-00	DPX2NE-40MP40MP
MIL-C-81659/35A2-0012	MME2R40S40S-00	
MIL-C-81659/35A2-0019	MME2R45P45P-00	DPX2NE-45MP45MP
MIL-C-81659/35A2-0020	MME2R45S45S-00	
MIL-C-81659/35A2-0027	MME2R57P57P-00	DPX2NE-57MP57MP
MIL-C-81659/35A2-0028	MME2R57S57S-00	

MIL-C-81659/35A2 Continued on page 3057

Military Cross Reference (Continued)

Government Designation	AMP Designation	ITT Cannon Designation
MIL-C-81659/35A2-0035	MME2R67P67P-00	DPX2NE-67MP67MP
MIL-C-81659/35A2-0036	MME2R67S67S-00	
MIL-C-81659/35A2-0043	MME2R106P106P-00	
MIL-C-81659/35A2-0044	MME2R106S106S-00	DPX2NE-A106SA106S
MIL-C-81659/35A2-0057	MME2R106S26P-00	DPX2NE-A106S26MP
MIL-C-81659/35A2-0058	MME2R106P26S-00	
MIL-C-81659/35A2-0059	MME2R26P106S-00	DPX2NE-26MPA106S
MIL-C-81659/35A2-0060	MME2R26S106P-00	
MIL-C-81659/35A2-0071	MME2R67P106S-00	DPX2NE-67MPA106S
MIL-C-81659/35A2-0072	MME2R67S106P-00	
MIL-C-81659/35A2-0089	MME2R106S67P-00	DPX2NE-A106S67MP
MIL-C-81659/35A2-0090	MME2R106P67S-00	
MIL-C-81659/35A2-0133	MME2R57P106S-00	DPX2NE-57MPA106S
MIL-C-81659/35A2-0134	MME2R57S106P-00	
MIL-C-81659/35A2-0147	MME2R57P26P-00	DPX2NE-57MP26MP
MIL-C-81659/35A2-0148	MME2R57S26S-00	
MIL-C-81659/37A2-0005	MME3P26P26P26P-00	
MIL-C-81659/37A2-0006	MME3P26S26S26S-00	DPX3NE-78M-33S-00
MIL-C-81659/37A2-0013	MME3P40P40P40P-00	DPX3NE-120M-33S-00
MIL-C-81659/37A2-0014	MME3P40S40S40S-00	
MIL-C-81659/37A2-0021	MME3P45P45P45P-00	
MIL-C-81659/37A2-0022	MME3P45S45S45S-00	DPX3NE-135M-33S-00
MIL-C-81659/37A2-0029	MME3P57P57P57P-00	DPX3NE-171M-33S-00
MIL-C-81659/37A2-0030	MME3P57S57S57S-00	
MIL-C-81659/37A2-0037	MME3P67P67P67P-00	
MIL-C-81659/37A2-0038	MME3P67S67S67S-00	DPX3NE-201M-33S-00
MIL-C-81659/37A2-0045	MME3P106P106P106P-00	DPX3NE-A318-33P-00
MIL-C-81659/37A2-0046	MME3P106S106S106S-00	
MIL-C-81659/37A2-0075	MME3P67P67P106S-00	
MIL-C-81659/37A2-0076	MME3P67S67S106P-00	DPX3NE-240M-33PS-00
MIL-C-81659/37A2-0079	MME3P67P106S67P-00	
MIL-C-81659/37A2-0080	MME3P67S106P67S-00	DPX3NE-A240M-33PS-00
MIL-C-81659/37A2-0091	MME3P106S106S67P-00	
MIL-C-81659/37A2-0092	MME3P106P106P67S-00	DPX3NE-279M-33PS-00
MIL-C-81659/39A2-0005	MME3R26P26P26P-00	DPX3NE-78M-34P-00
MIL-C-81659/39A2-0006	MME3R26S26S26S-00	
MIL-C-81659/39A2-0013	MME3R40P40P40P-00	DPX3NE-120M-34P-00
MIL-C-81659/39A2-0014	MME3R40S40S40S-00	
MIL-C-81659/39A2-0021	MME3R45P45P45P-00	DPX3NE-135M-34P-00
MIL-C-81659/39A2-0022	MME3R45S45S45S-00	
MIL-C-81659/39A2-0029	MME3R57P57P57P-00	DPX3NE-171M-34P-00
MIL-C-81659/39A2-0030	MME3R57S57S57S-00	
MIL-C-81659/39A2-0037	MME3R67P67P67P-00	DPX3NE-201M-34P-00
MIL-C-81659/39A2-0038	MME3R67S67S67S-00	
MIL-C-81659/39A2-0045	MME3R106P106P106P-00	
MIL-C-81659/39A2-0046	MME3R106S106S106S-00	DPX3NE-A318-34S-00
MIL-C-81659/39A2-0075	MME3R67P67P106S-00	DPX3NE-240M-34SP-00
MIL-C-81659/39A2-0076	MME3R67S67S106P-00	
MIL-C-81659/39A2-0079	MME3R67P106S67P-00	DPX3NE-A240M-34SP-00
MIL-C-81659/39A2-0080	MME3R67S106P67S-00	
MIL-C-81659/39A2-0091	MME3R106S106S67P-00	DPX3NE-279M-34SP-00
MIL-C-81659/39A2-0092	MME3R106P106P67S-00	
MIL-C-81659/41A2-0007	MME4P26P26P26P26P-00	
MIL-C-81659/41A2-0008	MME4P26S26S26S26S-00	DPX4NE-104M-33S-00
MIL-C-81659/41A2-0015	MME4P40P40P40P40P-00	
MIL-C-81659/41A2-0016	MME4P40S40S40S40S-00	DPX4NE-160M-33S-00
MIL-C-81659/41A2-0023	MME4P45P45P45P45P-00	
MIL-C-81659/41A2-0024	MME4P45S45S45S45S-00	DPX4NE-180M-33S-00
MIL-C-81659/41A2-0031	MME4P57P57P57P57P-00	
MIL-C-81659/41A2-0032	MME4P57S57S57S57S-00	DPX4NE-228M-33S-00

MIL-C-81659/41A2 Continued on page 3058

Military Cross Reference (Continued)

Government Designation	AMP Designation	ITT Cannon Designation
MIL-C-81659/41A2-0039	MME4P67P67P67P-00	
MIL-C-81659/41A2-0040	MME4P67S67S67S67S-00	DPX4NE-268M-33S-00
MIL-C-81659/41A2-0047	MME4P106P106P106P106P-00	DPX4NE-A424-33S-00
MIL-C-81659/41A2-0048	MME4P106S106S106S106S-00	
MIL-C-81659/41A2-0061	MME4P26P26P26P26S-00	
MIL-C-81659/41A2-0062	MME4P26S26S26S26P-00	
MIL-C-81659/41A2-0101	MME4P106S106S67P67P-00	
MIL-C-81659/41A2-0102	MME4P106P106P67S67S-00	DPX4NE-346M-33PS-00
MIL-C-81659/43A2-0007	MME4R26P26P26P26P-00	DPX4NE-104M-34P-00
MIL-C-81659/43A2-0008	MME4R26S26S26S26S-00	
MIL-C-81659/43A2-0015	MME4R40P40P40P40P-00	DPX4NE-160M-34P-00
MIL-C-81659/43A2-0016	MME4R40S40S40S40S-00	
MIL-C-81659/43A2-0023	MME4R45P45P45P45P-00	DPX4NE-180M-34P-00
MIL-C-81659/43A2-0024	MME4R45S45S45S45S-00	
MIL-C-81659/43A2-0031	MME4R57P57P57P57P-00	DPX4NE-228M-34P-00
MIL-C-81659/43A2-0032	MME4R57S57S57S57S-00	
MIL-C-81659/43A2-0039	MME4R67P67P67P67P-00	DPX4NE-268M-34P-00
MIL-C-81659/43A2-0040	MME4R67S67S67S67S-00	
MIL-C-81659/43A2-0047	MME4R106P106P106P106P-00	
MIL-C-81659/43A2-0048	MME4R106S106S106S106S-00	DPX4NE-A42A-34P-00
MIL-C-81659/43A2-0061	MME4R26P26P26P26S-00	
MIL-C-81659/43A2-0062	MME4R26S26S26S26P-00	
MIL-C-81659/43A2-0101	MME4R106S106S67P67P-00	DPX4NE-346M-34SP-00
MIL-C-81659/43A2-0102	MME4R106P106P67S67S-00	
MIL-C-81659/61A2-0001	MM1R26P-00	DPXBNE-26M-34P-29
MIL-C-81659/61A2-0002	MM1R26S-00	
MIL-C-81659/61A2-0009	MM1R40P-00	DPXBNE-40M-34P-29
MIL-C-81659/61A2-0010	MM1R40S-00	
MIL-C-81659/61A2-0017	MM1R45P-00	DPXBNE-45M-34P-29
MIL-C-81659/61A2-0018	MM1R45S-00	
MIL-C-81659/61A2-0025	MM1R57P-00	DPXBNE-57M-34P-29
MIL-C-81659/61A2-0026	MM1R57S-00	
MIL-C-81659/61A2-0033	MM1R67P-00	DPXBNE-67M-34P-29
MIL-C-81659/61A2-0034	MM1R67S-00	
MIL-C-81659/61A2-0041	MM1R106P-00	
MIL-C-81659/61A2-0042	MM1R106S-00	DPXBNE-A106-34S-29
MIL-C-81659/61A2-0083	MM1RD8P-00	DPXBNE-D8M-34P-29
MIL-C-81659/61A2-0084	MM1RD8S-00	
MIL-C-81659/62A2-0003	MM2R26P26P-00	DPX2NE-26MP26MP-34B-29
MIL-C-81659/62A2-0004	MM2R26S26S-00	
MIL-C-81659/62A2-0011	MM2R40P40P-00	DPX2NE-40MP40MP-34B-29
MIL-C-81659/62A2-0012	MM2R40S40S-00	
MIL-C-81659/62A2-0019	MM2R45P45P-00	DPX2NE-45MP45MP-34B-29
MIL-C-81659/62A2-0020	MM2R45S45S-00	
MIL-C-81659/62A2-0027	MM2R57P57P-00	DPX2NE-57MP57MP-34B-29
MIL-C-81659/62A2-0028	MM2R57S57S-00	
MIL-C-81659/62A2-0035	MM2R67P67P-00	DPX2NE-67MP67MP-34B-29
MIL-C-81659/62A2-0036	MM2R67S67S-00	
MIL-C-81659/62A2-0043	MM2R106P106P-00	
MIL-C-81659/62A2-0044	MM2R106S106S-00	DPX2NE-A106SA106S-34B-29
MIL-C-81659/62A2-0057	MM2R106S26P-00	DPX2NE-A106S26MP-34B-29
MIL-C-81659/62A2-0058	MM2R106P26S-00	
MIL-C-81659/62A2-0059	MM2R26P106S-00	DPX2NE-26MPA106S-34B-29
MIL-C-81659/62A2-0060	MM2R26S106P-00	
MIL-C-81659/62A2-0071	MM2R67P106S-00	DPX2NE-67MPA106S-34B-29
MIL-C-81659/62A2-0072	MM2R67S106P-00	
MIL-C-81659/62A2-0089	MM2R106S67P-00	DPX2NE-A106S67MP-34B-29
MIL-C-81659/62A2-0090	MM2R106P67S-00	
MIL-C-81659/62A2-0133	MM2R57P106S-00	DPX2NE-57MPA106S-34B-29
MIL-C-81659/62A2-0134	MM2R57S106P-00	

MIL-C-81659/62A2 Continued on page 3059

Military Cross Reference (Continued)

Government Designation	AMP Designation	ITT Cannon Designation
MIL-C-81659/62A2-0147	MM2R57P26P-00	DPX2NE-57MP26MP-34B-29
MIL-C-81659/62A2-0148	MM2R57S26S-00	
MIL-C-81659/63A2-0005	MM3R26P26P26P-00	DPX3NE-78M-34P-29
MIL-C-81659/63A2-0006	MM3R26S26S26S-00	
MIL-C-81659/63A2-0013	MM3R40P40P40P-00	DPX3NE-120M-34P-29
MIL-C-81659/63A2-0014	MM3R40S40S40S-00	
MIL-C-81659/63A2-0021	MM3R45P45P45P-00	DPX3NE-135M-34P-29
MIL-C-81659/63A2-0022	MM3R45S45S45S-00	
MIL-C-81659/63A2-0029	MM3R57P57P57P-00	DPX3NE-171M-34P-29
MIL-C-81659/63A2-0030	MM3R57S57S57S-00	
MIL-C-81659/63A2-0037	MM3R67P67P67P-00	DPX3NE-201M-34P-29
MIL-C-81659/63A2-0038	MM3R67S67S67S-00	
MIL-C-81659/63A2-0045	MM3R106P106P106P-00	
MIL-C-81659/63A2-0046	MM3R106S106S106S-00	DPX3NE-A318-34S-39
MIL-C-81659/63A2-0075	MM3R67P67P106S-00	DPX3NE-240M-34SP-29
MIL-C-81659/63A2-0076	MM3R67S67S106P-00	
MIL-C-81659/63A2-0079	MM3R67P106S67P-00	DPX3NE-A240M-34P-29
MIL-C-81659/63A2-0080	MM3R67S106P67S-00	
MIL-C-81659/63A2-0091	MM3R106S106S67P-00	DPX3NE-279M-34P-29
MIL-C-81659/63A2-0092	MM3R106P106P67S-00	
MIL-C-81659/64A2-0007	MM4R26P26P26P26P-00	DPX4NE-104M-34P-29
MIL-C-81659/64A2-0008	MM4R26S26S26S26S-00	
MIL-C-81659/64A2-0015	MM4R40P40P40P40P-00	DPX4NE-160M-34P-29
MIL-C-81659/64A2-0016	MM4R40S40S40S40S-00	
MIL-C-81659/64A2-0023	MM4R45P45P45P45P-00	DPX4NE-180M-34P-29
MIL-C-81659/64A2-0024	MM4R45S45S45S45S-00	
MIL-C-81659/64A2-0031	MM4R57P57P57P57P-00	DPX4NE-228M-34P-29
MIL-C-81659/64A2-0032	MM4R57S57S57S57S-00	
MIL-C-81659/64A2-0039	MM4R67P67P67P67P-00	DPX4NE-268M-34P-29
MIL-C-81659/64A2-0040	MM4R67S67S67S67S-00	
MIL-C-81659/64A2-0047	MM4R106P106P106P106P-00	
MIL-C-81659/64A2-0048	MM4R106S106S106S106S-00	DPX4NE-A424-34S-39
MIL-C-81659/64A2-0061	MM4R26P26P26P26S-00	
MIL-C-81659/64A2-0062	MM4R26S26S26S26P-00	
MIL-C-81659/64A2-0101	MM4R106S106S67P67P-00	DPX4NE-346M-34SP-29
MIL-C-81659/64A2-0102	MM4R106P106P67S67S-00	
MIL-C-81659/65A2-0001	M1P26P-00	
MIL-C-81659/65A2-0002	M1P26S-00	DPXBNA-26M-33S-00
MIL-C-81659/65A2-0009	M1P40P-00	
MIL-C-81659/65A2-0010	M1P40S-00	DPXBNA-49M-33S-00
MIL-C-81659/65A2-0017	M1P45P-00	
MIL-C-81659/65A2-0018	M1P45S-00	DPXBNA-45M-33S-00
MIL-C-81659/65A2-0025	M1P57P-00	
MIL-C-81659/65A2-0026	M1P57S-00	DPXBNA-57M-33S-00
MIL-C-81659/65A2-0033	M1P67P-00	
MIL-C-81659/65A2-0034	M1P67S-00	DPXBNA-67M-33S-00
MIL-C-81659/65A2-0041	M1P106P-00	DPXBNA-A106-33P-00
MIL-C-81659/65A2-0042	M1P106S-00	
MIL-C-81659/65A2-0083	M1PD8P-00	
MIL-C-81659/65A2-0084	M1PD8S-00	DPXBNA-D8M-33S-00
MIL-C-81659/66A2-0001	M1R26P-00	DPXBNA-26M-34P-00
MIL-C-81659/66A2-0002	M1R26S-00	
MIL-C-81659/66A2-0009	M1R40P-00	DPXBNA-40M-34P-00
MIL-C-81659/66A2-0010	M1R40S-00	
MIL-C-81659/66A2-0017	M1R45P-00	DPXBNA-45M-34P-00
MIL-C-81659/66A2-0018	M1R45S-00	
MIL-C-81659/66A2-0025	M1R57P-00	DPXBNA-57M-34P-00
MIL-C-81659/66A2-0026	M1R57S-00	
MIL-C-81659/66A2-0033	M1R67P-00	
MIL-C-81659/66A2-0034	M1R67S-00	

MIL-C-81659/66A2 Continued on page 3060

Military Cross Reference (Continued)

Government Designation	AMP Designation	ITT Cannon Designation
MIL-C-81659/66A2-0041	M1R106P-00	
MIL-C-81659/66A2-0042	M1R106S-00	DPXBNA-A106-34S-00
MIL-C-81659/66A2-0083	M1RD8P-00	DPXBNA-D8M-34P-00
MIL-C-81659/66A2-0084	M1RD8S-00	
MIL-C-81659/67A2-0001	M1R26P-01	DPXBNA-26M-34P-01
MIL-C-81659/67A2-0002	M1R26S-01	
MIL-C-81659/67A2-0009	M1R40P-01	DPXBNA-40M-34P-01
MIL-C-81659/67A2-0010	M1R40S-01	
MIL-C-81659/67A2-0017	M1R45P-01	DPXBNA-45M-34P-01
MIL-C-81659/67A2-0018	M1R45S-01	
MIL-C-81659/67A2-0025	M1R57P-01	DPXBNA-57M-34P-01
MIL-C-81659/67A2-0026	M1R57S-01	
MIL-C-81659/67A2-0033	M1R67P-01	DPXBNA-67M-34P-01
MIL-C-81659/67A2-0034	M1R67S-01	
MIL-C-81659/67A2-0041	M1R106P-01	
MIL-C-81659/67A2-0042	M1R106S-01	DPXBNA-A106-34S-01
MIL-C-81659/67A2-0083	M1RD8P-01	DPXBNA-D8M-34P-01
MIL-C-81659/67A2-0084	M1RD8S-01	
MIL-C-81659/68A2-0001	M1R26P-23	DPXBNA-26M-34P-23
MIL-C-81659/68A2-0002	M1R26S-23	
MIL-C-81659/68A2-0009	M1R40P-23	DPXBNA-40M-34P-23
MIL-C-81659/68A2-0010	M1R40S-23	
MIL-C-81659/68A2-0017	M1R45P-23	DPXBNA-45M-34P-23
MIL-C-81659/68A2-0018	M1R45S-23	
MIL-C-81659/68A2-0025	M1R57P-23	DPXBNA-57M-34P-23
MIL-C-81659/68A2-0026	M1R57S-23	
MIL-C-81659/68A2-0033	M1R67P-23	DPXBNA-67M-34P-23
MIL-C-81659/68A2-0034	M1R67S-23	
MIL-C-81659/68A2-0041	M1R106P-23	
MIL-C-81659/68A2-0042	M1R106S-23	DPXBNA-A106-34S-23
MIL-C-81659/68A2-0083	M1RD8P-23	DPXBNA-D8M-34P-23
MIL-C-81659/68A2-0084	M1RD8S-23	
MIL-C-81659/69A2-0003	M2P26P26P-00	
MIL-C-81659/69A2-0004	M2P26S26S-00	DPX2NA-26MS26MS-33B-00
MIL-C-81659/69A2-0011	M2P40P40P-00	
MIL-C-81659/69A2-0012	M2P40S40S-00	DPX2NA-40MS40MS-33B-00
MIL-C-81659/69A2-0019	M2P45P45P-00	
MIL-C-81659/69A2-0020	M2P45S45S-00	DPX2NA-45MS45MS-33B-00
MIL-C-81659/69A2-0027	M2P57P57P-00	
MIL-C-81659/69A2-0028	M2P57S57S-00	DPX2NA-57MS57MS-33B-00
MIL-C-81659/69A2-0035	M2P67P67P-00	
MIL-C-81659/69A2-0036	M2P67S67S-00	DPX2NA-67MS67MS-33B-00
MIL-C-81659/69A2-0043	M2P106P106P-00	DPX2NA-A106PA106P-33B-00
MIL-C-81659/69A2-0044	M2P106S106S-00	
MIL-C-81659/69A2-0057	M2P106S26P-00	
MIL-C-81659/69A2-0058	M2P106P26S-00	DPX2NA-A106P26MS-33B-00
MIL-C-81659/69A2-0059	M2P26P106S-00	
MIL-C-81659/69A2-0060	M2P26S106P-00	DPX2NA-26MSA106P-33B-00
MIL-C-81659/69A2-0071	M2P67P106S-00	
MIL-C-81659/69A2-0072	M2P67S106P-00	DPX2NA-67MSA106P-33B-00
MIL-C-81659/69A2-0089	M2P106S67P-00	
MIL-C-81659/69A2-0090	M2P106P67S-00	DPX2NA-A106P67MS-33B-00
MIL-C-81659/69A2-0133	M2P57P106S-00	
MIL-C-81659/69A2-0134	M2P57S106P-00	DPX2NA-57MSA106P-33B-00
MIL-C-81659/69A2-0147	M2P57P26P-00	
MIL-C-81659/69A2-0148	M2P57S26S-00	DPX2NA-57MS26MS-33B-00
MIL-C-81659/70A2-0003	M2R26P26P-00	DPX2NA-26MP26MP-34B-00
MIL-C-81659/70A2-0004	M2R26S26S-00	
MIL-C-81659/70A2-0011	M2R40P40P-00	DPX2NA-40MP40MP-34B-00
MIL-C-81659/70A2-0012	M2R40S40S-00	

MIL-C-81659/70A2 Continued on page 3061

Military Cross Reference (Continued)

Government Designation	AMP Designation	ITT Cannon Designation
MIL-C-81659/70A2-0019	M2R45P45P-00	DPX2NA-45MP45MP-34B-00
MIL-C-81659/70A2-0020	M2R45S45S-00	
MIL-C-81659/70A2-0027	M2R57P57P-00	DPX2NA-57MP57MP-34B-00
MIL-C-81659/70A2-0028	M2R57S57S-00	
MIL-C-81659/70A2-0035	M2R67P67P-00	DPX2NA-67MP67MP-34B-00
MIL-C-81659/70A2-0036	M2R67S67S-00	
MIL-C-81659/70A2-0043	M2R106P106P-00	
MIL-C-81659/70A2-0044	M2R106S106S-00	DPX2NA-A106SA106S-34B-00
MIL-C-81659/70A2-0057	M2R106S26P-00	DPX2NA-A106S26MP-34B-00
MIL-C-81659/70A2-0058	M2R106P26S-00	
MIL-C-81659/70A2-0059	M2R26P106S-00	DPX2NA-26MPA106S-34B-00
MIL-C-81659/70A2-0060	M2R26S106P-00	
MIL-C-81659/70A2-0071	M2R67P106S-00	DPX2NA-67MPA106S-34B-00
MIL-C-81659/70A2-0072	M2R67S106P-00	
MIL-C-81659/70A2-0089	M2R106S67P-00	DPX2NA-A106S67MP-34B-00
MIL-C-81659/70A2-0090	M2R106P67S-00	
MIL-C-81659/70A2-0133	M2R57P106S-00	DPX2NA-57MPA106A-34B-00
MIL-C-81659/70A2-0134	M2R57S106P-00	
MIL-C-81659/70A2-0147	M2R57P26P-00	DPX2NA-57MP26MP-34B-00
MIL-C-81659/70A2-0148	M2R57S26S-00	
MIL-C-81659/71A2-0003	M2R26P26P-01	DPX2NA-26MP26MP-34B-01
MIL-C-81659/71A2-0004	M2R26S26S-01	
MIL-C-81659/71A2-0011	M2R40P40P-01	DPX2NA-40MP40MP-34B-01
MIL-C-81659/71A2-0012	M2R40S40S-01	
MIL-C-81659/71A2-0019	M2R45P45P-01	DPX2NA-45MP45MP-34B-01
MIL-C-81659/71A2-0020	M2R45S45S-01	
MIL-C-81659/71A2-0027	M2R57P57P-01	DPX2NA-57MP57MP-34B-01
MIL-C-81659/71A2-0028	M2R57S57S-01	
MIL-C-81659/71A2-0035	M2R67P67P-01	DPX2NA-67MP67MP-34B-01
MIL-C-81659/71A2-0036	M2R67S67S-01	
MIL-C-81659/71A2-0043	M2R106P106P-01	
MIL-C-81659/71A2-0044	M2R106S106S-01	DPX2NA-A106SA106A-34B-01
MIL-C-81659/71A2-0057	M2R106S26P-01	DPX2NA-A106S26MP-34B-01
MIL-C-81659/71A2-0058	M2R106P26S-01	
MIL-C-81659/71A2-0059	M2R26P106S-01	DPX2NA-26MPA106S-34B-01
MIL-C-81659/71A2-0060	M2R26S106P-01	
MIL-C-81659/71A2-0071	M2R67P106S-01	DPX2NA-67MPA106S-34B-01
MIL-C-81659/71A2-0072	M2R67S106P-01	
MIL-C-81659/71A2-0089	M2R106S67P-01	DPX2NA-A106S67MP-34B-01
MIL-C-81659/71A2-0090	M2R106P67S-01	
MIL-C-81659/71A2-0133	M2R57P106S-01	DPX2NA-57MPA106A-34B-01
MIL-C-81659/71A2-0134	M2R57S106P-01	
MIL-C-81659/71A2-0147	M2R57P26P-01	DPX2NA-57MP26MP-34B-01
MIL-C-81659/71A2-0148	M2R57S26S-01	
MIL-C-81659/72A2-0003	M2R26P26P-23	DPX2NA-26MP26MP-34B-23
MIL-C-81659/72A2-0004	M2R26S26S-23	
MIL-C-81659/72A2-0011	M2R40P40P-23	DPX2NA-40MP40MP-34B-23
MIL-C-81659/72A2-0012	M2R40S40S-23	
MIL-C-81659/72A2-0019	M2R45P45P-23	DPX2NA-45MP45MP-34B-23
MIL-C-81659/72A2-0020	M2R45S45S-23	
MIL-C-81659/72A2-0027	M2R57P57P-23	DPX2NA-57MP57MP-34B-23
MIL-C-81659/72A2-0028	M2R57S57S-23	
MIL-C-81659/72A2-0035	M2R67P67P-23	DPX2NA-67MP67MP-34B-23
MIL-C-81659/72A2-0036	M2R67S67S-23	
MIL-C-81659/72A2-0043	M2R106P106P-23	
MIL-C-81659/72A2-0044	M2R106S106S-23	DPX2NA-A106SA106S-34B-23
MIL-C-81659/72A2-0057	M2R106S26P-23	DPX2NA-A106S26MP-34B-23
MIL-C-81659/72A2-0058	M2R106P26S-23	
MIL-C-81659/72A2-0059	M2R26P106S-23	DPX2NA-26MPA106S-34B-23
MIL-C-81659/72A2-0060	M2R26S106P-23	

MIL-C-81659/72A2 Continued on page 3062

Military Cross Reference (Continued)

Government Designation	AMP Designation	ITT Cannon Designation
MIL-C-81659/72A2-0071	M2R67P106S-23	DPX2NA-67MPA106S-34B-23
MIL-C-81659/72A2-0072	M2R67S106P-23	
MIL-C-81659/72A2-0089	M2R106S67P-23	DPX2NA-A106S67MP-34B-23
MIL-C-81659/72A2-0090	M2R106P67S-23	
MIL-C-81659/72A2-0133	M2R57P106S-23	DPX2NA-57MPA106A-34B-23
MIL-C-81659/72A2-0134	M2R57S106P-23	
MIL-C-81659/72A2-0147	M2R57P26P-23	DPX2NA-57MP26MP-34B-23
MIL-C-81659/72A2-0148	M2R57S26S-23	

Product Facts

- Simple installation
- Easy reentry
- Simplified maintenance and repair
- Excellent mechanical and environmental resistance
- Efficient strain relief
- Flexibility
- Versatility

Introduction

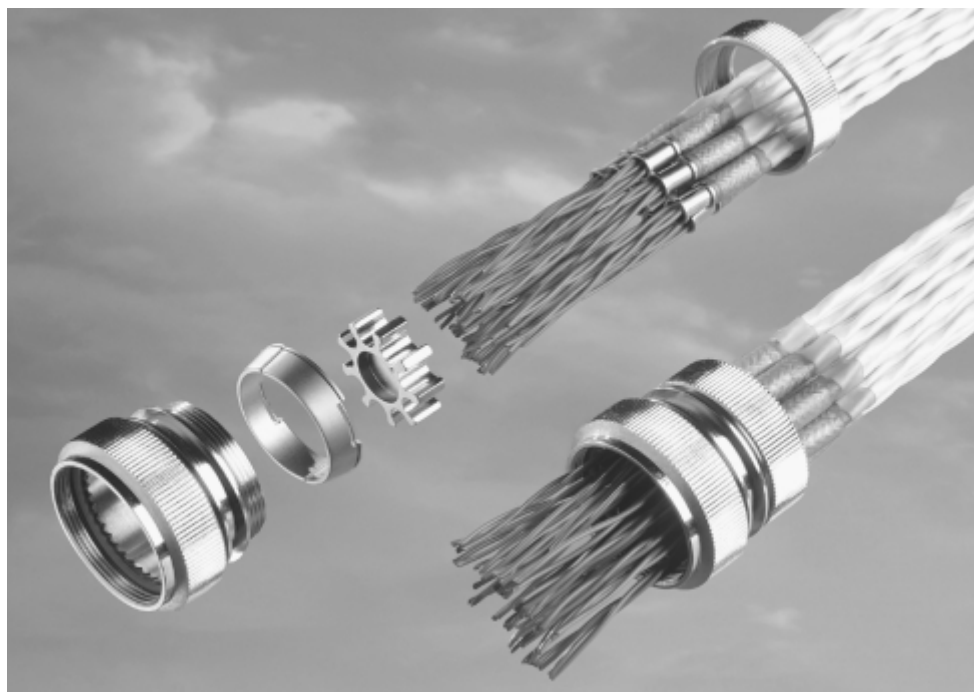

Applications

Tyco Electronics, a longtime leader in harnessing technology, has written a new chapter in EMC shielding with the introduction of the HexaShield EMC adapter.

Designed to provide EMC protection solutions for both commercial and military applications, HexaShield adapters represent a significant improvement over pig-tail termination methods. By providing 360-degree EMC shielding on the termination area of each individual cable, HexaShield adapters provide outstanding shielding effectiveness.

HexaShield adapters are simple to install, easy to

maintain, and dependably resistant to mechanical and environmental stresses.

Principal points and features

- Easy reentry: To insert or remove ferrules from the HexaShield adapter, simply loosen the back nut.
- Superior protection: No degradation of shielding performance.
- Up to four shielded cables accommodated by each ferrule.
- Mechanical and environmental protection equal to backshells complying with MIL-C-85049 Category 3B.
- Strain relief on each individual cable.

- Weight reduction, by possibly eliminating the need for overall shielding.
- Compact size — not exceeding outer diameter of connector.

Simple, one-piece assembly and installation

1. Solder cable or wire shield to a ferrule with a Raychem heat-shrinkable SolderShield terminator.
2. Clip ferrule into one of the grounding star cavities.
3. Secure the back nut of the HexaShield adapter so that the conic ring assembly automatically compresses the ferrules.

Designed to corresponding connector specifications.

Two Platings Available	Raychem Product Specifications
Electroless nickel (MIL-C-26074)	RB-110 and RB-114
Olive drab cadmium (QQ-P-416 Type II Class 3)	—

Installation Procedures

Installation procedure for HET-A-02X and HET-A-04X (RPIP-696-00)	Installation procedure for HET-03X (RPIP-696-03)	General procedure for cylindrical connectors, right-angle body (RPIP-696-07)
General procedure for ARINC 600 Size II connectors (RPIP-696-01)	General procedure for cylindrical connectors, straight body (RPIP-696-04)	—
General procedure for ARINC 600 Size III connectors (RPIP-696-02)	—	—

METRIC
Dimensions are millimeters over inches

Hexashield Adapters for Circular Connectors: Straight, 45° and 90° Assemblies

Item	Description
1	Straight adapter assembly
2	Conic ring assembly
3	Star Plain (Standard) Drilled (Option) Split (Option) _
4	Straight adapter assembly - L version - nominally 12.7 [0.5] longer body
5	45° adapter assembly - welded
6	45° adapter assembly - cast
7	90° adapter assembly - welded
8	90° adapter assembly - cast Standard products shown. Variants available on request. Split star assemblies are shown on relevant S.C.D's where applicable.
Item	HexaShield Version
-1	Back Nut
-2	Tinel adapter assembly Tinel-Lock ring for single braid
-3	Bandstrap adapter assembly
-C	Conduit adapter

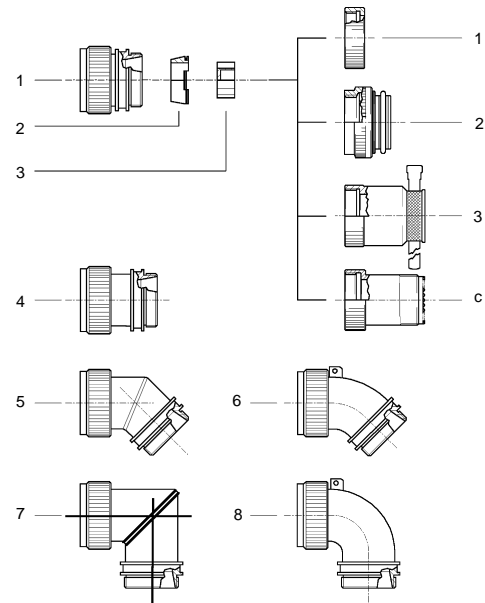

HexaShield Adapters for ARINC 404/600 Connectors: Sizes 1, 2, 3 and 4 Assemblies

Item	Description
1	Left side support
2	Right side support
3	Retention bars
4	Body assemblies Body Holding nut Conic ring assembly Star _ Back nut
5	Cavity plug assemblies Plug Holding nut
6	Pan head screws - 4-40 UNC
7	Spring washers ARINC 600 Size 2 shown Stars are available as plain, drilled or split. See relevant S.C.D's for further information

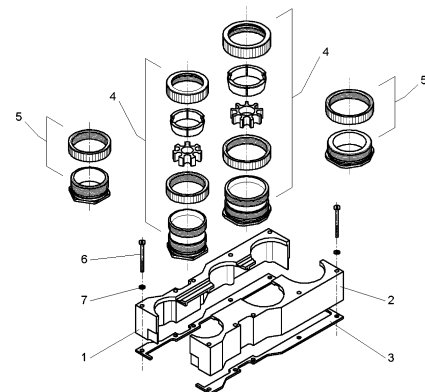

METRIC
Dimensions are millimeters over inches

Part Numbering for Standard Products

HexaShield Adapter for Circular Connectors

HEXYY L -AY -00 S -YY -AY -Y -DS

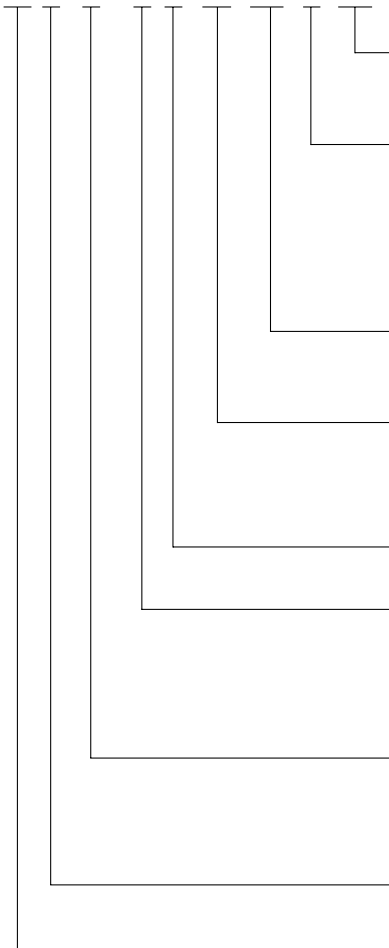

Drilled Star:

*See SCD for Star options (star within a star)

Type of Back Nut:

- 1 = Standard back nut
- 2 = Clamping nut for tinell ring (for overbraid protection)
- 3 = Clamping nut with bandstrap
- C = Clamping nut for conduit applicator

Max. number of ferrules that can be accommodated, from 1 for size 9, to 12 for size 25

Hexashield Size Code:

(09, 11, 13, 15, 17, 19, 21, 23, 25) according to MIL-C-38999 Series 3 and 4 connectors

S = Swept version

Configuration:

- 00 = Straight body
- 45 = 45 degree angle body
- 90 = 90 degree angle body

Type of Plating:

- B = Cadmium plated
- C = Electroless nickel

L = Long body

Connector Code Number:

- 40 = MIL-C-38999 Series 3 and 4
- 41 = MIL-C-38999 Series 1 and 2
- 54 = MIL-C-38723 Series 1 and 3
- MIL-C-25482 Series 2

METRIC

Dimensions are millimeters over inches

Ordering Information (Continued)

HexaShield Adapter for Collins Connectors

HEXDB-AC-00-A9-1

00 = Straight body
90 = Right-angle body

HexaShield Adapter for ARINC 600 Connectors

HEXA6-AY-00-YY-YYY-1

Maximum number of ferrules that can be accommodated:

18 for ARINC size II
36 for ARINC size III

ARINC Connector Size

02 = ARINC 600 size II
03 = ARINC 600 size III

Type of Plating:

B = Cadmium plated

Part Numbering of Ferrule Kits

HET-A-02X for small-size cable with SolderShield terminator

HET-A-03X for connection of unshielded cables
ferrules with heat-shrinkable tubing (no shield)

HET-A-04X for large-size cables with SolderShield terminator

Type of Plating:

B = Cadmium plated
C = Electroless nickel

HEX07-AX ferrule - solid blank for use when a HET-A is not needed

Type of Plating:

B = Cadmium plated
C = Electroless nickel

*Not all part numbers are standard; contact Tyco Electronics for assistance in selecting the appropriate standard product

METRIC

Dimensions are millimeters over inches

Product Facts

- Outperforms traditional pigtail termination, especially in HIRF performance
- Withstands 10-kA peak current lightning transients of SAE AE4L-87-3 rev. B

EMC Performance

Transfer Impedance

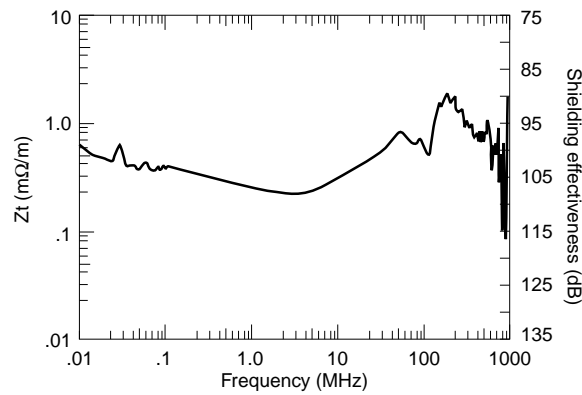

HexaShield size: 23
 Cable: Raychem 5024H8424 (one cable installed)
 Test method: CEI 96-1

Protection Level

Generalized system performance (Actual system performance in any one test method may differ.)

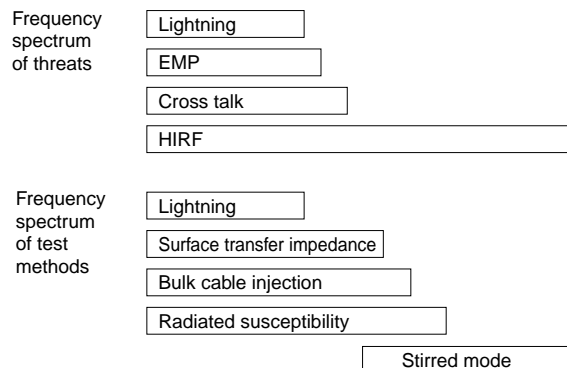
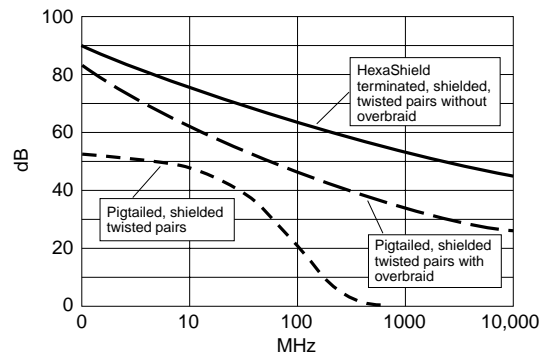

METRIC
 Dimensions are millimeters over inches

Typical HexaShield Applications**EMC Performance (Continued)**

Civilian and military aircraft
Avionics
Fighter aircraft
Missiles and launch support systems
Armored and military support vehicles
Navy ships (total shipboard hardening)
Military communications
Engines (FADEC harness hardening)

HexaShield Product Range

Accommodates the following connector types*:
MIL-C-38999 Series 1, 2, 3, and 4
MIL-C-26482 Series 2
MIL-C-83723 Series 1 and 3
DBAD
ARINC 600
ARINC 404

*Please contact Tyco Electronics for other connector types and special requests.

METRIC

Dimensions are
millimeters over inches

单击下面可查看定价，库存，交付和生命周期等信息

[>>TE Connectivity\(泰科\)](#)