

REVISIONS

P	LTR	DESCRIPTION	DATE	DWN	APVD
A		INITIAL	25MAR2015	DW	CW
B		ECR-15-018270	08DEC2015	DW	CW
BI		ECR-18-004560	27MAR2018	CH	CW
C		ECR-21-111798	29SEP2021	WQR	CW

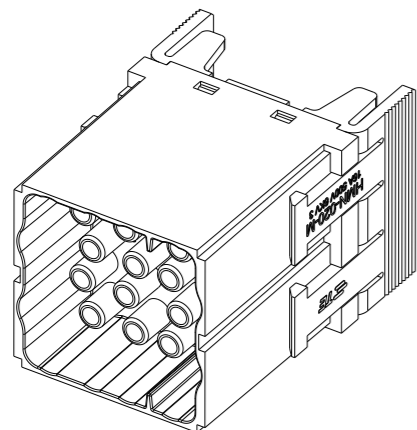

TYPE-1: T2111202101-000
 类型-1: T2111202101-000

LASER PRINT MARKING, ARIAL FONT,
 HEIGHT 2mm, LOCATION PER ACTUAL POSITION
 激光打标, ARIAL 字体, 字高2mm, 位置按实际情况调整.

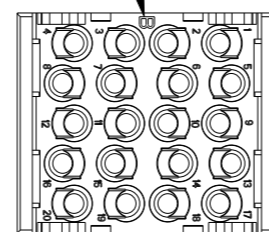
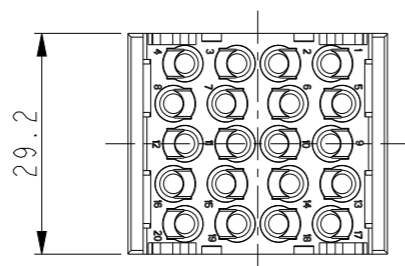

TYPE-3: T2111202101-B00,
 THIS TYPE IS SAME AS TYPE-1,
 ONLY ADD LASER PRINT MARKING "B"
 类型-3: T2111202101-B00
 此类型同类型-1, 只是增加了激光打标"B".

NOTES:

- TECHNICAL CHARACTERISTICS:
 INSULATION MATERIAL: PC
 RATED VOLTAGE: 500V
 RATED CURRENT: 16A
 INSULATION RESISTANCE: >=400MΩ
 RATED IMPULSE VOLTAGE: 6KV
 POLLUTION DEGREE: 3
 FLAMMABILITY: UL94V-0
 MATING CYCLES: 500 CYCLES
 OPERATION TEMPERATURE: -40~+125°C
 WIRE RANGE: 0.14~4.0 mm² (26~12 AWG)
 CONTACT TYPE: CRIMP CONTACT
- CONTACT NEED TO BE ORDERED SEPARATELY.
 (ORDER No. REFER TO DRAWING:T20300X10XX000)

注释:

- 技术参数:
 绝缘材料: PC
 额定电压: 500V
 额定电流: 16A
 绝缘电阻: >=400MΩ
 额定脉冲电压: 6KV
 污染等级: 3
 阻燃等级: UL94V-0
 插拔次数: 500次
 工作温度: -40~+125°C
 接线范围: 0.14~4.0 mm² (26~12 AWG)
 接线类型: 冷压接
- 端子需要单独订购.
 (订货号参考图面: T20300X10XX000)

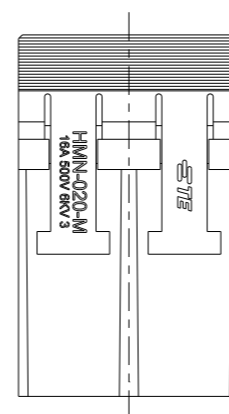
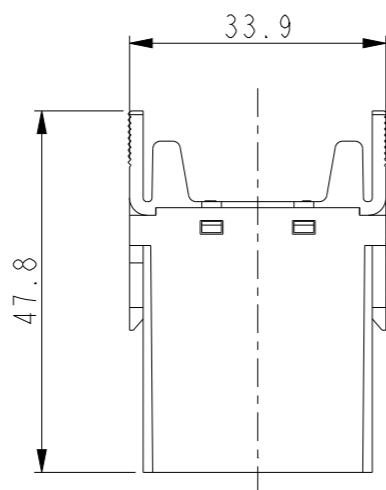
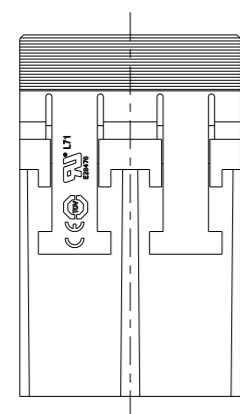

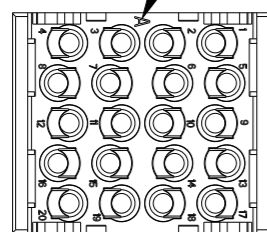

LASER PRINT MARKING, ARIAL FONT,
 HEIGHT 2mm, LOCATION PER ACTUAL POSITION
 激光打标, ARIAL 字体, 字高2mm, 位置按实际情况调整.

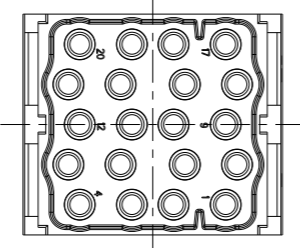

TYPE-2: T2111202101-A00,
 THIS TYPE IS SAME AS TYPE-1,
 ONLY ADD LASER PRINT MARKING "A"
 类型-2: T2111202101-A00
 此类型同类型-1, 只是增加了激光打标"A".



PART NUMBER 料号	PART DESCRIPTION 描述	TYPE 类型
T2111202101-B00	HMN-020-M HMN-020 MALE MODULE INSERT, MARK B HMN-020 模块公插, 打B标识	TYPE-3 类型-3
T2111202101-A00	HMN-020-M HMN-020 MALE MODULE INSERT, MARK A HMN-020 模块公插, 打A标识	TYPE-2 类型-2
T2111202101-000	HMN-020-M HMN-020 MALE MODULE INSERT HMN-020 模块公插	TYPE-1 类型-1

THIS DRAWING IS A CONTROLLED DOCUMENT.		DWN 25MAR2015 DAVID.WANG	 TE Connectivity			
DIMENSIONS: mm		CHK 25MAR2015 CHRIS.WANG			NAME HMN-020-M	
TOLERANCES UNLESS OTHERWISE SPECIFIED:		APVD 25MAR2015 XIANG.XU				
		PRODUCT SPEC 108-137063			RESTRICTED TO	
MATERIAL		APPLICATION SPEC 114-137063	SIZE A3	CAGE CODE 00779	DRAWING NO T2111202101000	REV C
-		WEIGHT -	SCALE 1:1		SHEET 1 OF 1	Customer Drawing

单击下面可查看定价，库存，交付和生命周期等信息

[>>TE Connectivity\(泰科\)](#)