

- 1. PLASTIC: PC, TRANSPARENT
CONTACT: Cu ALLOY, TIN PLATED
- 2. COLOUR: BUTTON IN GREEN,
HOUSING TRANSPARENT

REVISIONS					
P	LTR	DESCRIPTION	DATE	DWN	APVD
	I	NEW DRAWING	20JUN2019	RS	MZ
	A	REVISED PER ECR-19-014117	11SEP2019	SR	MZ

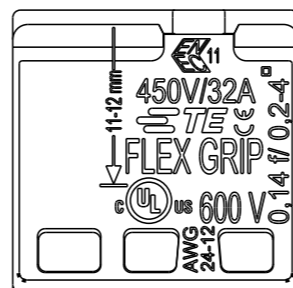

For flexible wires open/close the release lever
For rigid wires it is not necessary to open the lever before pushing in the wire

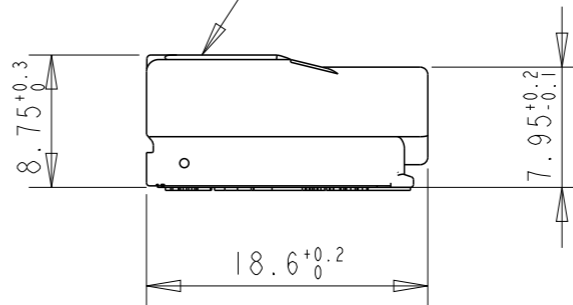
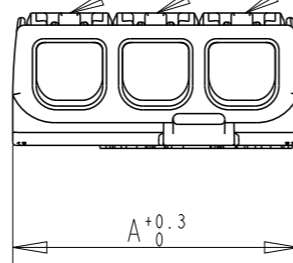
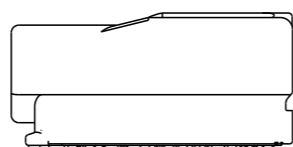

RELEASE LEVER GREEN

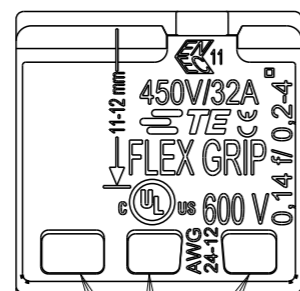
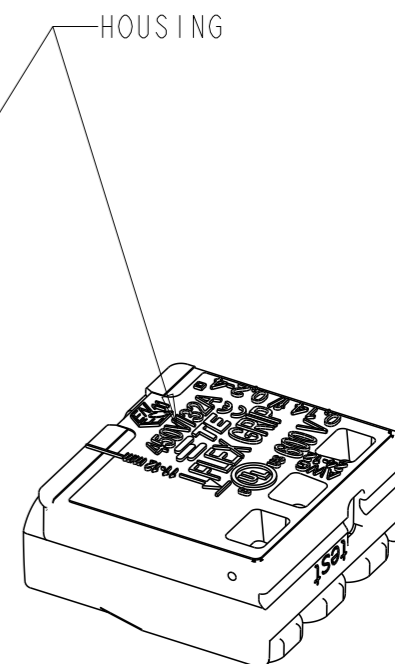
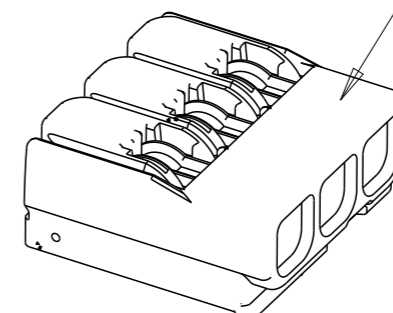
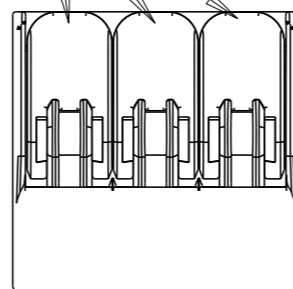

2337895-3 AS SHOWN

Control window for correctly skinned and pushed-in wires

30.3	5	5	FLEX GRIP CONNECTOR	2337895-5
18.9	3	3	FLEX GRIP CONNECTOR	2337895-3
13.2	2	2	FLEX GRIP CONNECTOR	2337895-2
DIM A	NO. OF LEVERS	NO. OF POSN.	DESCRIPTION	PART NO.

THIS DRAWING IS A CONTROLLED DOCUMENT.		DWN 20JUN2019 RAVI.S		
DIMENSIONS: mm		CHK 20JUN2019 MARCO ZUCCA		
TOLERANCES UNLESS OTHERWISE SPECIFIED:		APVD 20JUN2019 MARCO ZUCCA	NAME FLEX GRIP FAMILY, 2, 3 AND 5 POS	
		PRODUCT SPEC	SIZE CAGE CODE DRAWING NO RESTRICTED TO	
0 PLC ±- 1 PLC ±- 2 PLC ±- 3 PLC ±- 4 PLC ±- ANGLES ±-		APPLICATION SPEC	A3 00779 C-2337895	
MATERIAL SEE NOTES		WEIGHT	SCALE 2:1 SHEET 1 OF 2 REV A	
		CUSTOMER DRAWING		

REVISIONS

P	LTR	DESCRIPTION	DATE	DWN	APVD
-	-	SEE SHEET 1	-	-	-

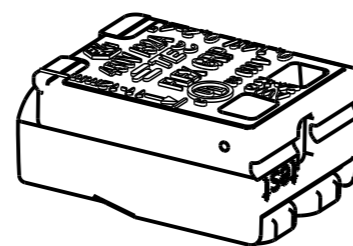
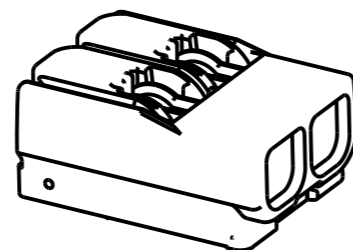
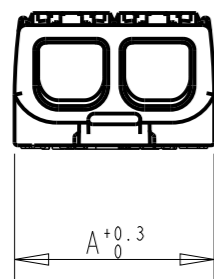

2337895-2 AS SHOWN
SAME AS 2337895-3 EXCEPT SHOWN

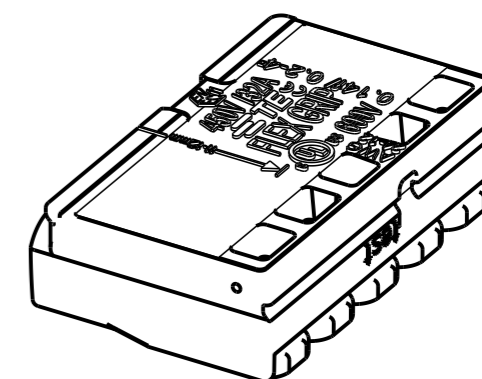
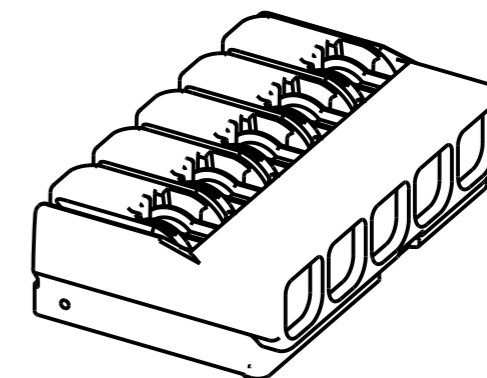
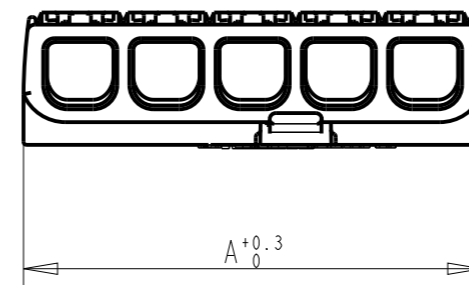

2337895-5 AS SHOWN
SAME AS 2337895-3 EXCEPT SHOWN

THIS DRAWING IS A CONTROLLED DOCUMENT.

DIMENSIONS:
mm

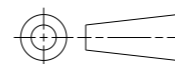

MATERIAL
SEE NOTES

TOLERANCES UNLESS OTHERWISE SPECIFIED:

- 0 PLC ±-
- 1 PLC ±-
- 2 PLC ±-
- 3 PLC ±-
- 4 PLC ±-
- ANGLES ±-
- FINISH -

DWN RAVI.S 20JUN2019

CHK MARCO ZUCCA 20JUN2019

APVD MARCO ZUCCA 20JUN2019

PRODUCT SPEC -

APPLICATION SPEC -

WEIGHT -

CUSTOMER DRAWING



TE Connectivity

NAME
FLEX GRIP FAMILY,
2, 3 AND 5 POS

SIZE CAGE CODE DRAWING NO RESTRICTED TO

A3 00779 C-2337895

SCALE 2:1 SHEET 2 OF 2 REV A

单击下面可查看定价，库存，交付和生命周期等信息

[>>TE Connectivity\(泰科\)](#)