



TE Connectivity

# CUSTOMER DATA

PART NO.

1432793-1

SHT. 1  
OF 2

DRAWN E.SIMPSON	APPROVAL B. TOEPFER	DATE FIRST_DRAWN 05-26-05	SCALE 1:1
--------------------	------------------------	------------------------------	--------------

CUSTOMER  
TYCO\_ELECTRONICS\_STANDARD

TOLERANCE 0.X = +/-  
 UNLESS 0.XX = +/-  
 SPECIFIED 0.XXX = +/-  
 OTHERWISE ANGLES = +/-

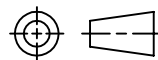

DO NOT SCALE THIS DRAWING

### CHANGES

REV.	DATE	CO	APP.
	04OCT2016	ECR-16-014229	B.T.
	06NOV2017	ECO-17-003787	B.T.

NOT TO BE USED IN AUTOMOTIVE APPLICATIONS OR APPLICATIONS REQUIRING PPAP AND/OR IMDS DOCUMENTATION  
ELECTRICAL CHARACTERISTICS: (ALL DATA APPLIES @ 23°C UNLESS OTHERWISE SPECIFIED)

#### COIL DATA:

NOMINAL VOLTAGE: 12 VDC  
 OPERATE VOLTAGE: 7.8 VDC MAXIMUM  
 RELEASE VOLTAGE: 1.2 VDC MINIMUM  
 COIL RESISTANCE: 90 OHMS +/- 10%  
 OPERATE TIME: 10 mSEC. MAXIMUM EXCLUDING BOUNCE  
 RELEASE TIME: 13 mSEC. MAXIMUM EXCLUDING BOUNCE  
 TEMPERATURE RANGE: OPERATING -40°C TO +85°C

#### CONTACT DATA: (CONTACT DATA IS FORMATTED N.O./N.C.)

CONTACT ARRANGEMENT: 1 FORM C (SPDT)  
 CONTACT MATERIAL: AgSnO (SILVER TIN-OXIDE)  
 CONTACT MILLIVOLT DROP: 200mv @ 35A ON N.O. CONTACTS (AFTER SWITCHING)  
 250mv @ 20A ON N.C. CONTACTS (AFTER SWITCHING)  
 MAXIMUM MAKE CURRENT: 90A/30A (LAMP) @ 16 VDC  
 MAXIMUM BREAK CURRENT: 40A/30A @ 16 VDC RESISTIVE  
 MAXIMUM CONTINUOUS CURRENT: 40A/30A @ 23°C , 35A/20A @ 85°C  
 INITIAL BREAKDOWN CURRENT 500V RMS CONTACTS TO COIL

EXPECTED LIFE: 100,000 OPERATIONS, 40 A, 14 VDC RESISTIVE ON NORMALLY OPEN CONTACT

#### MECHANICAL CHARACTERISTICS:

EXPECTED LIFE: 10 MILLION OPERATIONS, NO CONTACT LOAD  
 TERMINALS COPPER, UNPLATED



TE Connectivity

# CUSTOMER DATA

PART NO.

1432793-1

SHT. 2  
OF 2

DRAWN E.SIMPSON	APPROVAL B. TOEPFER	DATE FIRST_DRAWN 05-26-05	SCALE 1:1
--------------------	------------------------	------------------------------	--------------

CUSTOMER  
TYCO\_ELECTRONICS\_STANDARD

TOLERANCE 0.X = +/-  
 UNLESS 0.XX = +/-  
 SPECIFIED 0.XXX = +/-  
 OTHERWISE ANGLES = +/-

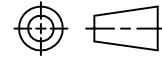

DO NOT SCALE THIS DRAWING

REV D

MILLIMETERS

### MARKING TO INCLUDE:

TYCO ELECTRONICS NAME, TYCO ELECTRONICS PART NUMBER, SCHEMATIC, COIL VOLTAGE, COUNTRY OF ORIGIN, AND DATE CODE

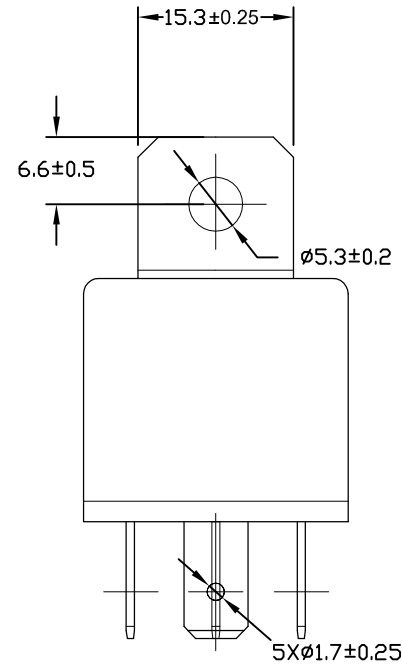
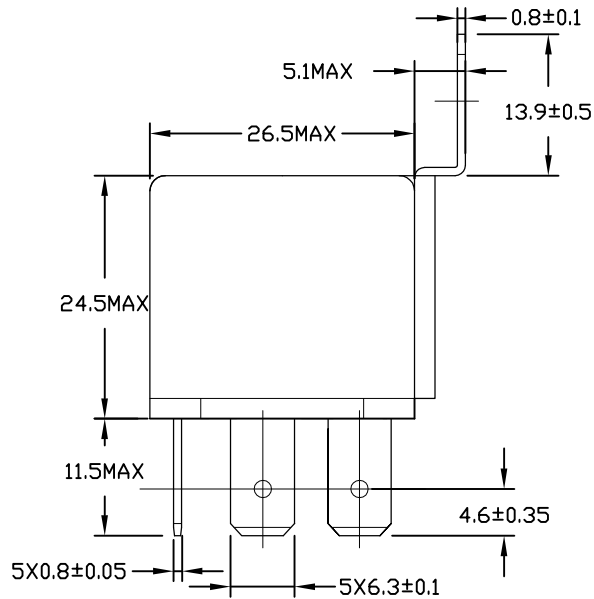

K Aspect

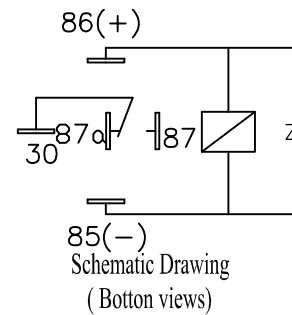
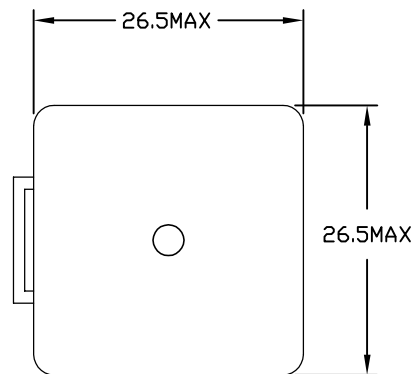
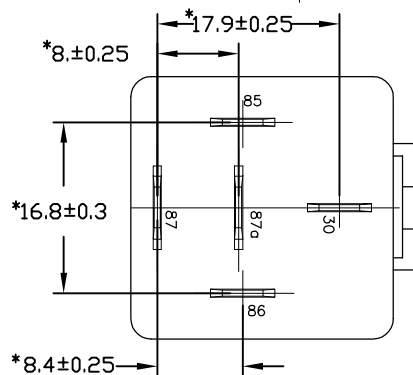

\* TERMINAL LOCATIONS APPLY AT THE BASE OF THE TERMINALS

NOT TO BE USED IN AUTOMOTIVE APPLICATIONS OR APPLICATIONS REQUIRING PPAP AND/OR IMDS DOCUMENTATION

单击下面可查看定价，库存，交付和生命周期等信息

[>>TE Connectivity\(泰科\)](#)