

**Power Relay RF**

- 1 pole 16A, 1 form A (NO) or 1 form B (NC) contact
- Coil power 400mW
- Reinforced insulation (EN 61810, 60335, 60730)
- Ambient temperature up to 105°C
- Quick connect terminals for load side
- WG version: Materials in accordance to IEC 60335-1

Typical applications

Oven control, electric heating, power supplies, air conditioning, microwave ovens, hobs

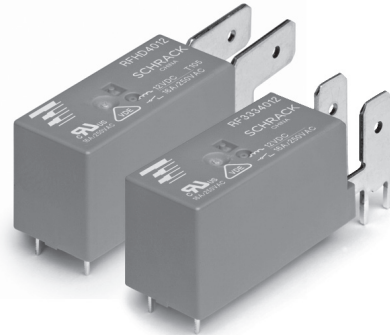

F0273-BI



**Approvals**

VDE REG.-Nr. A652, UL E214025, CQC 05001014817  
Technical data of approved types on request

**Contact Data**

Contact arrangement	1 form A (NO) or 1 form B (NC)
Rated voltage	250VAC
Max. switching voltage	400VAC
Rated current	16A
Limiting making current, form A contact, max. 4s, duty factor 10 %	25A
Breaking capacity max.	4000VA
Contact material	AgNi 90/10
Min. recommended contact load	12VAC at 500mA
Frequency of operation, with/without load	360/72000h <sup>-1</sup>
Operate/release time max.	11/7ms
Bounce time max., form A/form B	4/4ms

**Contact ratings**

Type	Contact	Load	Cycles
<b>IEC 61810</b>			
RF334; RFH34	A (NO)	16A, 250VAC resistive, 85°C	100x10 <sup>3</sup>
RF334; RFH34	A (NO)	11A, 250VAC resistive, 85°C	250x10 <sup>3</sup>
RF334; RFH34	A (NO)	20A, 250VAC resistive, 85°C	25x10 <sup>3</sup>
RF334; RFH34	A (NO)	25A, 250VAC resistive, 70°C	15x10 <sup>3</sup>
RF354; RFH54	B (NC)	16A, 250VAC resistive, 85°C	100x10 <sup>3</sup>
RF354; RFH54	B (NC)	20A, 250VAC resistive, 85°C	50x10 <sup>3</sup>
RF354; RFH54	B (NC)	25A, 250VAC resistive, 70°C	20x10 <sup>3</sup>
RFH34	A (NO)	16A, 250VAC resistive, 105°C	100x10 <sup>3</sup>
RFH34	A (NO)	11A, 250VAC resistive, 105°C	250x10 <sup>3</sup>
RFH34	A (NO)	18.5A, 250VAC resistive, 105°C	20x10 <sup>3</sup>
RFH34	A (NO)	10A, 400VAC resistive, 105°C	150x10 <sup>3</sup>

Mechanical endurance >10x10<sup>6</sup> operations

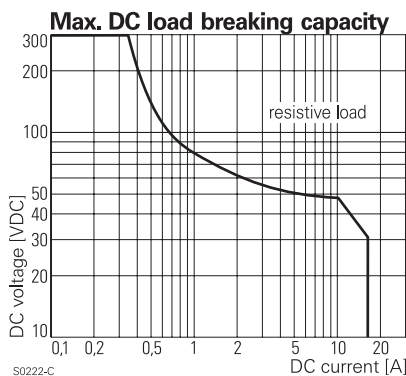

**Coil Data**

Coil voltage range	5 to 60VDC
Operative range, IEC 61810	2
Coil insulation system according UL1446	class F

**Coil versions, DC coil**

Coil code	Rated voltage VDC	Operate voltage VDC	Release voltage VDC	Coil resistance Ω±10%	Rated coil power mW
005	5	3.5	0.5	62	403
006	6	4.2	0.6	90	400
009	9	6.3	0.9	203	399
012	12	8.4	1.2	360	400
024	24	16.8	2.4	1440	400
048	48	33.6	4.8	5520	417
060	60	42.0	6.0	8570	420

All figures are given for coil without pre-energization, at ambient temperature +23°C. Other coil voltages on request.

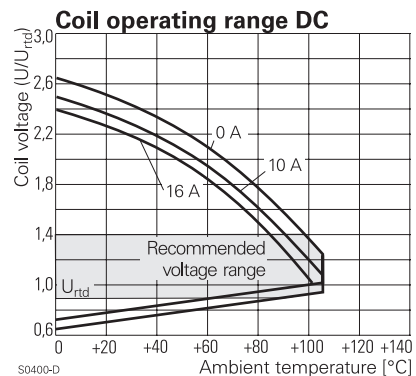

**Insulation Data**

Initial dielectric strength	
between open contacts	1000V <sub>rms</sub>
between contact and coil	4000V <sub>rms</sub>
Clearance/creepage	
between contact and coil	≥8/8mm
Material group of insulation parts	IIIa
Tracking index of relay base	PTI250V

**Power Relay RF (Continued)**

**Other Data**

Material compliance: EU RoHS/ELV, China RoHS, REACH, Halogen content refer to the Product Compliance Support Center at [www.te.com/customersupport/rohssupportcenter](http://www.te.com/customersupport/rohssupportcenter)

Resistance to heat and fire	
WG version	according EN 60335-1, par.30
Ambient temperature	
RF3	-40 to 85°C
RFH	-40 to 105°C
Category of environmental protection	
IEC 61810	RTII - flux proof <sup>1)</sup>
Vibration resistance (functional), form A/form B, 55 to 500Hz	20/5g
Shock resistance (destructive)	100g
Terminal type	PCB-THT, quick connect for load side
Weight	20g
Resistance to soldering heat THT, IEC 60068-2-20	
flux proof version	270°C/10s
wash tight version	260°C/5s
Packaging/unit	tray/30 pcs., box/300 pcs.

1) RTIII - wash tight version on request

**PCB layout / terminal assignment**

Bottom view on solder pins

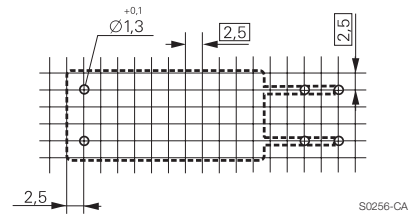

S0256-CA

1 form A (NO) contact

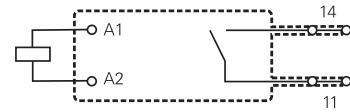

S0256-CB

1 form B (NC) contact

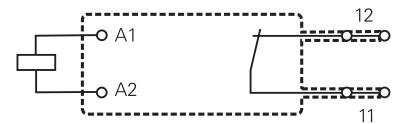

S0256-CC

**Dimensions**

Quick connect terminals vertical

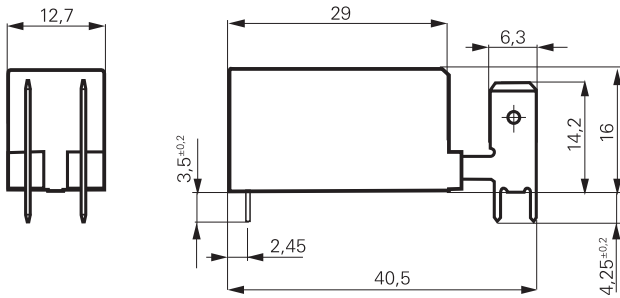

S0282-CI

Quick connect terminals horizontal

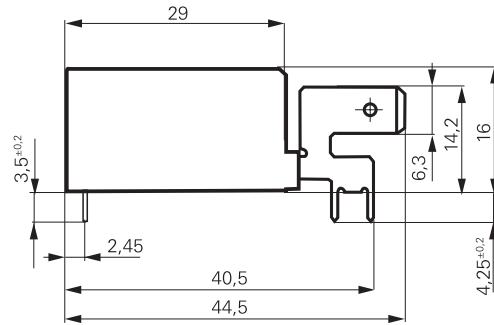

S0282-CJ

**Power Relay RF** (Continued)

<b>Product code structure</b>		Typical product code		<b>RF</b>	<b>3</b>	<b>3</b>	<b>4</b>	<b>012</b>	<b>WG</b>
<b>Type</b>		RF Power Relay RF							
<b>Version</b>		<b>3</b> 16A, 85°C		<b>H</b> 16A, 105°C					
<b>Contact configuration</b>		<b>3</b> 1 form A (NO) contact, quick connect term. vertical		<b>D</b> 1 form A (NO) contact, quick connect term. horizontal					
		<b>5</b> 1 form B (NC) contact, quick connect term. vertical		<b>F</b> 1 form B (NC) contact, quick connect term. horizontal					
<b>Contact material</b>		<b>4</b> AgNi 90/10							
<b>Coil</b>		Coil code: please refer to coil versions table							
<b>Version</b>		<b>Blank</b> Standard version							
		<b>WG</b> Product in accordance with IEC 60335-1 (domestic appliances)							

Wash tight version on request

Product code	Contact arrangement	Version	Coil	Version	Part number
RF334012	1 form A (NO)	85°C	12VDC	Standard	8-1415513-1
RFH34009WG	contact	105°C	9VDC	IEC60335-1 compliant	4-1415520-1
RFH34012WG			12VDC		5-1415520-1
RFH34024			24VDC	Standard	1415511-1
RFH54006WG	1 form B (NC)		6VDC	IEC60335-1 compliant	1415521-1
RFH54024WG	contact		24VDC		3-1415521-1
RFHD4012WG	1 form A (NO)		12VDC		9-1415521-1

This list represents the most common types and does not show all variants covered by this datasheet.  
Other types on request

单击下面可查看定价，库存，交付和生命周期等信息

[>>TE Connectivity\(泰科\)](#)