

108-5056

NUMBER

Customer Release

AMP SECURITY CLASSIFICATION

108-5056

Product Specification
 AMPMODU MOD IV Interconnection System

1. Scope:

This specification covers the performance and test requirements for AMPMODU MOD IV interconnection system, having tin-plated or 0.4μ thick gold-plated crimp type contacts. This interconnection system consists of crimp type contacts, receptacle housing(s) and post assembly which is mounted on printed circuit board. Receptacle contacts, having design feature to snap in housing, can be easily accommodated in housings in 2.5mm, 2.54mm and 5mm center line spacings depending upon the application type. The product part numbers and descriptions, governed under this product specification, are shown in Table 5.

2. Applicable Documents:

The following documents form a part of this specification to the extent indicated herein.

2.1 Military Specifications and Federal Specifications:

QQ-C-533	Beryllium Copper
QQ-B-750	Phosphor Bronze
MIL-G-45204	Gold Plating, Electrodeposited
QQ-N-290	Nickel Plating, Electrodeposited
MIL-STD-202	Test Methods for Electronic and Electric Component Parts

2.2 AMP Specifications:

109-6	Test Specification, D.C. Dry Circuit Measurements of Separable Electrical Connectors
112-162	Finish Specification, Gold-Plating
112-42	" " " " , Nickel Plating
112-143	" " " " , Tin Plated Strip
108-9209	Application of AMPMODU MOD IV Receptacle Contact
114-5026	Application Specification, Crimping AMPMODU MOD IV Crimp, Snap-in Contact

3. Definitions:

For the purpose of this specification, the following definitions shall apply:

3.1 Connector Assembly:

A mated pair of connector assemblies, consisting of receptacle housing having wire-crimped contacts in specified contact positions and center line spacings, and its counterpart post housing assembly having post contacts for interconnection with printed circuit board, shall constitute a connector assembly.

PRINT DIST	DR. <i>L. Yamada</i> 10-27-77				 AMP (Japan), Ltd. TOKYO, JAPAN	
	CHK. <i>L. Yamada</i> 10-27-77					
	APP. <i>L. Yamada</i> 10-27-77					
				LOG. J A	NO. 108-5056	REV. E
	E Revised RFA-313			SHEET NAME Product Specification		
	LTR REVISION RECORD	DR	CHK	DATE	1 OF 13 AMPMODU MOD IV Interconnection System	

AMP SECURITY CLASSIFICATION
 Customer Release
 NUMBER
 108-5056

3.2 Receptacle Contacts:

Receptacle contacts are female contacts with an open wire barrel for crimping. The receptacle contacts are stamped and formed in a rectangular shape. The contact feature has two integral cantilever beam spring members for contact with the post and a retaining latch for retention to the housing.

3.3 Receptacle Housing:

Receptacle housing is a molded plastic insulating member for multiposition contact termination, made of the material specified in Para. 4.1, that accommodates receptacle contacts in the cavities. For module type housings, the blocks of 2, 3, 4 and 8-position are available, and by composing these types of component block housings, an assembly of 12 or 16 or 20-positions can be provided.

3.4 Post Connector Assembly:

Post connector housing is a rectangular type housing having 0.64mm square posts in the specified center line spacings. One end of the post is mated with the counterpart receptacle contact and the other end is staked into printed circuit board and soldered to form the termination.

4. Mechanical and Electrical Performance Requirements:

4.1 Material and Finish:

Material and finish shall be as specified herein: If a substitute material is used the performance requirements of this specification must be met.

4.1.1 Contact Material:

4.1.1.1 Post Contact:

Post contact shall be made of phosphor bronze, conforming to Federal Specification QQ-B-750.

4.1.1.2 Receptacle Contact:

Receptacle contact shall be made of beryllium copper conforming to Federal Specification QQ-C-533.

4.1.2 Contact Finish:

The contact shall be plated with either pre-tin or gold over nickel. Thickness shall be in accordance with the applicable product drawing(s). Plating specifications shall be as follows:

4.1.2.1 Gold Plating: AMP 112-162 and MIL-G-45204

4.1.2.2 Nickel Plating: AMP 112-42, and QQ-N-290

4.1.2.3 Tin Plating: AMP 112-143

SHEET				AMP (Japan), Ltd.	
2 OF 13				TOKYO, JAPAN	
LOG	J	A	NO	108-5056	REV
NAME		Product Specification			
AMPMODU MOD IV Interconnection System					

4.1.3 Housing:

Receptacle housing and post housing shall be made of molded NORYL* thermo-plastic polyphenylene oxide (PPO) or glass-filled 6/6 NYLON*, conforming to UL-94V1.

4.2 Current Rating:

Current rating across a mated pair of contacts shall be in accordance with the rated values specified in Table 1, unless otherwise confined by the capacity of wires employed.

4.3 Temperature Rating:

Connector assemblies shall be capable of continuous operation throughout the ambient temperature range specified in Table 1.

Housing Material	Temperature Limits		Rated Current (A)	
	Max.	Min.	#20-24(AWG)	#26-28(AWG)
Glass-filled 6/6 NYLON	105°C	-65°C	3.5 A	2 A
NORYL (PPO)	85°C	-40°C	3 A	1.5A

Table 1

4.4 Dimensions:

All the products specified under this product specification shall have physical dimensions conforming to applicable product drawing(s).

5. Performance Requirements and Test Methods:

5.1 Qualification:

Qualification of the products under this product specification shall be accomplished by testing the connector assemblies specified below to the applicable test sequence in Table 4.

5.1.1 Group "A" Samples:

Crimped receptacles in housings mated to posts mounted in grid panels shall be tested to Test Sequence specified in Table 4 for qualification.

5.1.2 Group "B" Samples:

Crimped receptacle contacts shall be tested in accordance with the Test Sequence specified in Table 4, by the groups of wire sizes crimped.

SHEET			AMP (Japan), Ltd. TOKYO, JAPAN	
3 OF 13	LOC	NO	108-5056	REV
	J	A		E
NAME Product Specification				
AMP MODU MOD IV Interconnection System				

5.1.3 Group "C" Samples:

Module connect type connector samples shall be tested in this group consisting of receptacle housings in 2, 3, 4 and 4 positions.

5.1.4 Group "D" Samples:

Group "D" samples consisting of post housing assemblies shall be tested in accordance with Test Sequence specified in Table 4.

5.2 Test Conditions:

All the tests shall be conducted in any combination of the following test conditions.

Temperature: 15 - 35°C
Humidity: 45 - 75%
Atmospheric Pressure: 650 - 800 mmHg

5.3 Termination Resistance(Low Level):

When tested in accordance with the test method specified in Para. 6.1, low level termination resistance shall be not exceeding 12mΩ for gold-plated contacts and not exceeding 18mΩ for tin-plated contacts.

5.4 Insulation Resistance:

When tested in accordance with the test method specified in Para. 6.2, insulation resistance of connector housings other than module-connect type shall be not less than 5,000MΩ, and not less than 1,000MΩ for module connect type housings.

5.5 Dielectric Strength:

When tested in accordance with the test method specified in Para. 6.3, dielectric strength between adjacent contacts shall be such that no abnormalities occur at test potential of 1,000 VAC for connectors other than module-connect type housings, and at 750 VAC for module-connect type housings, where no evidence of insulation break-down and flashover shall be present.

5.6 Insertion/Extraction Force:

When tested in accordance with the test method specified in Para. 6.4, insertion force per contact shall be not greater than 370g for gold-plated contacts, and not greater than 450g for tin-plated contacts, and extraction force shall be commonly not less than 45g per contact position.

5.7 Vibration:

When tested in accordance with the test method specified in Para. 6.5, connector assemblies shall show no electrical discontinuity greater than 1×10^{-6} second in the test circuit during vibration, and cracks, damages and loose of parts after vibration, shall be not evident.

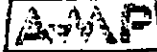
SHEET			AMP (Japan), Ltd. TOKYO, JAPAN	
4 OF 13	LOG	NO	108-5056	REV
	J	A		E
NAME Product Specification				
AMPHODU MOD IV Interconnection System				

5.8 Repeated Insertion/Extraction:

When tested in accordance with the test method specified in Para. 6.6, no physical damages shall take place on connector assemblies and contacts after conditioning, and connector performance must be conforming to the requirements for termination resistance in accordance with Para. 5.3, and for insertion/extraction force in accordance with Para. 5.6.

5.9 Thermal Shock:

When tested in accordance with the test method specified in Para. 6.7, connector assemblies shall show no abnormalities such as cracks, warpage, blister and bend. Discoloration and tactile change without degrading functional performance shall not cause rejection of products. Connector assemblies shall be capable of mating and unmating without abnormalities.

5.10 Humidity(Steady State):

When tested in accordance with the test method specified in Para. 6.8, insulation resistance shall be not less than 100MΩ after conditioning, and connector assemblies shall have dielectric strength conforming to requirements specified in Para. 5.5. Discoloration and tactile change without degrading functional performance shall not cause rejection of products. Connector assemblies shall be also capable to meet the requirements for termination resistance specified in Para. 5.3.

5.11 Salt Spray:

When tested in accordance with the test method specified in Para. 6.9, connector assemblies shall meet the requirements for termination resistance specified in Para. 5.3, and shall show no corrosive defects that are detrimental to connector insertion and extraction.

5.12 Retention Force of Receptacle Contacts to Housing:

When tested in accordance with the test method specified in Para. 6.10, receptacle contacts shall be not dislodged from the housing cavities by the axial pull off load of 1.5 kg.

5.13 Crimp Tensile Strength:

When tested in accordance with the test method specified in Para. 6.11, crimp tensile strength shall be not less than the values specified in Table 2.

Crimp Tensile Strength

Wire Size mm ² (AWG)	Crimp Tensile Strength (Min.)	
	kg	(Pounds)
0.5 (#20)	7.9	(17.4)
0.3 (#22)	4.9	(10.8)
0.2 (#24)	3.1	(6.8)
0.14 (#26)	1.8	(4.0)
0.085 (#28)	1.2	(2.6)

Table 2

SHEET				AMP (Japan), Ltd.	
5 OF 13				TOKYO, JAPAN	
LOC	J	NO	108-5056	REV	E
NAME Product Specification					
AMPMODU MOD IV Interconnection System					

NUMBER 108-5056
 Customer Release
 AMP SECURITY CLASSIFICATION

5.14 Lateral Snapping Force of Module -Connect Type Housings at Assembly and Disassembly:

When tested in accordance with the test method specified in Para. 6.12, lateral snapping force to assemble and disassemble Module-Connect housings shall be conforming to the values specified in Table 3.

Initial Snapping Force to Assemble Housings		Initial Snapping Force to Disassemble Housings	
kg	(Pound)	kg	(Pound)
3.0 Max.	(6.6)	0.2 Min.	(0.44)

Table 3

5.15 Solderability:

When tested in accordance with the test method specified in Para. 6.13, 75% of total tested area of sample contact shall be covered with sufficiently effective fresh solder without presence of concentrated pinholes, voids and dewetting, after the test by dipping in solder tub. However, this is not required in examination into cut surface of tin-plated base metal.

5.16 Post Retention Force:

When tested in accordance with the test method specified in Para. 6.14, post contact shall be not dislodged from housing cavity by the axial pull-off load not greater than 1.0 kg.

6. Test Conditions:

6.1 Termination Resistance(Low Level):

Low level termination resistance shall be tested in accordance with Test Method 307 of MIL-STD-202, by applying closed circuit test current not exceeding 50mA at open circuit voltage of 50 mV flowint through the circuit. Measurement shall be done at the probing points as shown in Fig. 2. From the measured value, resistance of 75mm long crimped wire shall be deducted. The calculated value shall be conforming to the requirements specified in Para. 5.3.

6.2 Insulation Resistance:

Insulation resistance of unmated connector assemblies shall be tested in accordance with Test Condition B, Test Method 302 of MIL-STD-202. The measured value shall be conforming to the requirements specified in Para. 5.4.

6.3 Dielectric Strength:

Dielectric strength of unmated connector assemblies shall be tested in accordance with Test Method 301 of MIL-STD-202, by applying test potential of 1,000V AC or 750 V AC, as applicable depending upon the housing type, for 1 minute. Test potential shall be applied between adjacent contacts. Test potential shall be increased at a rate of 500 V a second, and after reaching the specified votage level, it shall be held for 1 minute. After test conditioning, connector shall show appearance conforming to the requirement specified in Para. 5.5.

SHEET				AMP (Japan), Ltd. TOKYO, JAPAN	
6 OF 13	LOC J	NO A	108-5056	REV E	
NAME Product Specification					
ANPMODU MOD IV Interconnection System					

6.4 Insertion/Extraction Force:

Connector assemblies shall be fixed on the head of tensile testing machine whose mating/unmating direction must be aligned properly for engagement and disengagement when axial load to push in or pull off is applied at a rate of 100mm per minute. When engagement and disengagement force is measured, the measured values shall be divided by the number of contact positions to obtain average insertion/extraction force per contact position. The calculated values shall be conforming to the requirements specified in Para. 5.6. For MODULAR AMPMODU connectors, mated pair of connector assemblies shall be fastened on the testing machine.

6.5 Vibration:

Mated pair of connector assemblies shall be tested in accordance with Test Method 201A of MIL-STD-202, by fixing on the vibrating table of tester at the height properly arranged for testing without allowing wires to be affected by vibration of table. The end of crimped wires of 75 mm in length shall be secured by clamp. While vibratile test conditioning, all the contacts shall be series wires and test current of 0.1 A shall be applied through the test circuit, which shall be monitored for occurrence of electrical discontinuity greater than 1 microsecond. After completion of vibratile conditioning, the sample connector assembly shall be conforming to the requirements specified in Para. 5.7.

6.6 Repeated Insertion/Extraction:

Connector assemblies shall be tested for repeated insertion and extraction for 100 cycles for gold-plated products and 20 cycles for tin-plated products at a rate of 400 - 600 cycles per hour. After completion of cycling repetition, sample connector shall be conforming to the requirements specified in Para. 5.8.

6.7 Thermal Shock:

Mated pair of connector assemblies shall be tested in accordance with Test Method 107 of MIL-STD-202. For connectors made of Noryl, Test Condition A shall be applied except lower temperature extreme at -40°C, and for connector made of glass-filled 6/6 Nylon, Test Condition B shall be applied except upper temperature extreme to be 105°C. After thermal test conditioning, samples shall be tested for mating/unmating function, and they shall be conforming to the requirements specified in Para. 5.9.

6.8 Humidity (Steady State):

Mated connector assemblies shall be tested for humidity performance in accordance with Test Condition B, Test Method 103 of MIL-STD-202. After completion of test conditioning, sample connector assemblies shall be dried in room temperature for 24 hours, and measured for termination resistance. The measured values shall be conforming to the requirements specified in Para. 5.10.

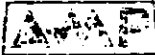
SHEET				AMP (Japan) Ltd. TOKYO, JAPAN	
7 OF 13		LOG	NO	108-5056	
		J	A	REV E	
NAME Product Specification					
AMPMODU MOD IV Interconnection System					

AMP SECURITY CLASSIFICATION
 Customer Release
 NUMBER 108-5056

6.9 Salt Spray:

Mated pair of connector assemblies shall be tested for salt spray performance in accordance with Test Condition B, Test Method 101 of MIL-STD-202. After completion of test conditioning, sample connector shall be rinsed and dried in room temperature. The sample connector shall be tested for termination resistance, and measured values shall be conforming to the requirements specified in Para. 5.11, and connector assemblies shall be free from corrosive defects detrimental to connector functions.

6.10 Receptacle Contact Retention Force:

Fasten the receptacle contact-loaded connector housing on the tensile testing machine, and apply an axial pull-off load to the crimped wire by operating the head to travel with the speed at a rate of 100 mm a minute. Contact retention force is determined when the wire is broken or contact is pulled out of the loaded position in housing cavity. The measured values shall be conforming to the requirements specified in Para. 5.12.

6.11 Crimp Tensile Strength:

Fasten the wire crimped contact on the head of tensile testing machine, and apply an axial pull off load to the crimped wire by operating the head to travel with the speed at a rate of 100mm a minute. Crimp tensile strength is determined when the wire is broken or is pulled out of the wire crimp. The measured values shall be conforming to the requirements specified in Para. 5.13.

6.12 Lateral Snapping Force of Module Connect Type Housings at Assembly and Disassembly:

Fasten a pair of component Module-Connect type housings on tensile testing machine in the manner that they are aligned correctly to be snapped together or separated laterally as to be assembled or disassembled. The force is applied to mate and unmate the housings by operating the head to travel with the speed at a rate of 100mm a minute. The measured values shall be conforming to the requirements specified in Para. 5.14. This snapping test shall be given to all combinations among all types of Module-Connect housings.

6.13 Solderability:

Solderability test shall be applied to post contact ends for termination with printed circuit board, in accordance with the following conditions.

- (1) Temperature of Melted Solder: 230 \pm 5°C, (446 \pm 9.0°F)
- (2) Solder Used: 60% Tin, 40% Lead
- (3) Flux, Pretreated: ALPHA # 100 or equivalent
- (4) Time of Immersion in Flux Tub: 5 - 10 seconds
- (5) Time of Dipping in Solder Tub: 5 \pm 0.5 seconds

Size of solder tub, immersion and emersion rate and magnification rate for inspection shall be in accordance with Test Method 208 of MIL-STD-202. The result of inspection shall be conforming to requirements specified in Para. 5.15.

SHEET				AMP (Japan), Ltd. TOKYO, JAPAN	
8 OF 13	LOC J	A	NO 108-5056	REV E	
NAME Product Specification					
AMPMODU MOD IV Interconnection System					

6.14 Post Retention Force:

Secure post assembly on the test fixture, and apply an axial pull off load to extract post contact from housing on the tensile testing machine by operating the head to travel with the speed at a rate of 100 mm a minute. The force required to separate the post from housing must be measured. The measured value shall be conforming to the requirements specified in Para. 5.16.

6.15 Temperature Rising:

Connector assembly shall be tested for temperature rising performance by applying test current of specified intensity. Measurement shall be done after 30 minutes when temperature rising becomes stabilized by probing the wire crimp by using Digital Thermocouple Model TR-6994-33 made by Takeda Riken K.K. through the probing hole which is cut through the housing wall at the location over contact wire crimp. Measurement shall be done by probing 5 contacts in the middle part of connector. The measured value shall be not greater than those specified in Table 1 in Para. 4.3.

7. Flux Cleaner:

When to remove flux from post assembly and printed circuit board, where flux is overflowed to contaminate termination by chance, use any of the following 3 types of cleaning solvent.

I.P.A. Isopropyl Alcohol
 Flon DAIFLON*S3-P35. $CCl_2F-CClF_2/(CH_3)_2CHOH$,
 or DAIFLON* S3 $CCl_2F-CClF_2$, manufactured by:

Daikin Kogyo K.K., #8, Umeda, Kita-ku, Osaka, Japan zip code 530
 or equivalent: suggesting information= FLON S3 is equivalent to Flon R 113

(a) Time of Immersion:

I.P.A.	5 minutes maximum
DAIFLON S3-P35	2 minutes maximum
DAIFLON S3	2 minutes maximum

(b) Temperature of Solvent:

Name of Solvent	Immersion	Vaporized Cleaning
I.P.A.	50°C max.	Not Applicable
DAIFLON S3-P35	40°C max.	Not applicable
DAIFLON S3	40°C max.	Applicable

(c) Flux:

E-3V manufactured by Nihon Handa Kogyo K.K.
 or ALPHA No. 100

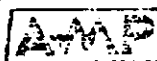
SHEET				AMP (Japan), Ltd. TOKYO, JAPAN	
9 OF 13		LOG	A	NO	108-5056
NAME		Product Specification			
ANPMODU MOD IV Interconnection System					

NUMBER 108-5056
 Customer Release
 AMP SECURITY CLASSIFICATION

Test Item and Test Sequence:

Test Sequence	Connector Assemblies			Crimped Receptacle Contact	Module-Connect Type Housing	Post Assemblies		Requirements Paragraph Number	Test Method Paragraph Number
	A	A'	A''	B	C	D	D'		
Insertion Force	X							5.6	6.4
Termination Resistance (Low Level)	X	X						5.3	6.1
Extraction Force	X							5.6	6.4
Insulation Resistance		X						5.4	6.2
Dielectric Strength		X						5.5	6.3
Vibration	X							5.7	6.5
Repeated Insertion/Extraction	X							5.8,5.6	6.6
Termination Resistance (Low Level)	X							5.3	6.1
Thermal Shock		X						5.9	6.7
Humidity		X						5.10	6.8
Termination Resistance (Low Level)		X						5.3	6.1
Insulation Resistance		X						5.10	6.2
Dielectric Strength		X						5.5	6.3
Salt Spray		X						5.11	6.9
Termination Resistance (Low Level)		X						5.3	6.1
Receptacle Contact Retention Force	X							5.12	6.10
Post Retention Force							X	5.16	6.14
Solderability							X	5.15	6.13
Lateral Snapping Force of Module-Connect Type Housings at Assembly and Disassembly						X		5.14	6.12
Crimp Tensile Strength				X				5.13	6.11
Temperature Rising			X					4.3	6.15
Number of Samples	5 sets	5 sets	2 sets	10 pcs	10 sets each	10 pcs	10 pcs		

Table 4

SHEET			AMP (Jeon), Ltd. TOKYO, JAPAN	
10 OF 13	LCC	J A	NO 108-5056	REV E
NAME Product Specification				
AMP MODU MOD IV Interconnection System				

108-5056

NUMBER

Customer Release

AMP SECURITY CLASSIFICATION

Applicable Housing and Contact Part Numbers:

Center Line Spacing (mm)	Descriptions	Part Number	Type & Specification	Material
2.5	Module-Connect Receptacle Housing	171769-1	M-2P	NORYL
		171770-1	R-2P	
		171771-1	M-3P	
		171772-1	L-4P	
		171773-1	R-4P	
	171774-1	L-8P		
2.5	Receptacle Housing	171172-1	12-Pos.	Housing: Glass-filled NORYL* Post: Phosphor Broze
		171271-1	20-Pos.	
	Post Assembly	171171-2	12-Pos. w/Ear	
		171270-2	20-Pos. w/Ear	
		171811-1, -2	12-Pos.	
		171817-1, -2	16-Pos.	
2.54 (.100)	Receptacle Housing	171785-1, -2	Double Row 20,24-Pos.	Glass-filled NYLON 6/6
		-3, -4	" " 36, 52-Pos.	
		171784-1	Single Row 20-Pos.	
2.54 (.100)	Post Assembly	171783-1, -2	Double Row 20, 24-Pos.	Housing: Glass-filled 6/6 NYLON Post: Phosphor Bronze
		-3, -4 171782-1	" " 36, 52-Pos. Single Row 20-Pos.	
5.0	Receptacle Housing	171775-1	6-Pos.	NORYL
		171776-1	10-Pos.	
5.0	Post Assembly	171779-1, -2	6-Pos.	Housing: Glass-filled NORYL Post: Phosphor Bronze
		171818-1, -2	8-Pos.	
		171780-1, -2	10-Pos.	
X	Receptacle Contact	85969-6	AWG #20-24, Gold Plated	Beryllium Copper
		171275-1	" #20-24, " "	
		171275-2	" #20-24, Tin Plated	
		170231-1	" #20-24, " "	
		170230-1	" #26-28, " "	

Table 5

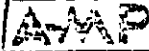
SHEET				AMP (Japan), Ltd TOKYO, JAPAN	
11 OF 13	LOG	J	A	NO 108-5056	REV E
NAME Product Specification					
ANPMODU MOD IV Interconnection System					

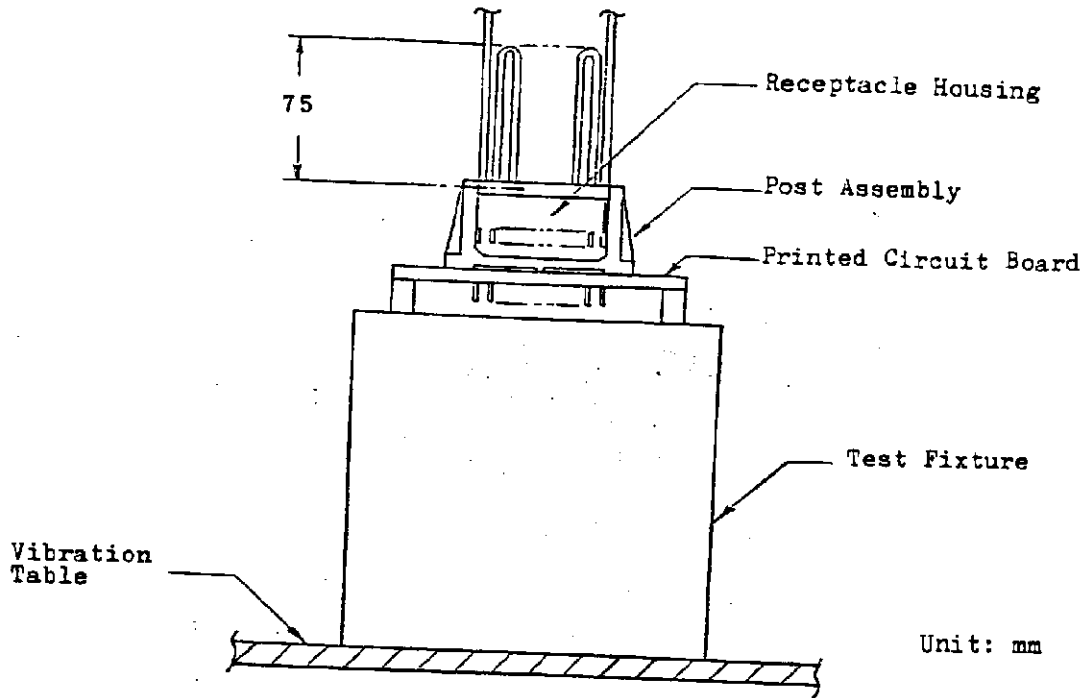

Fig. 1 Vibration Test Method

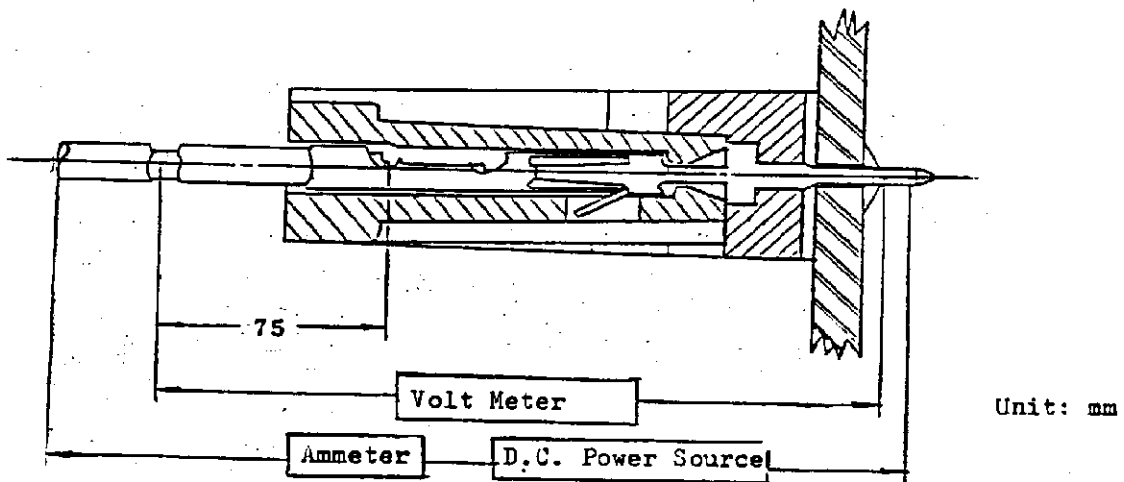



Fig. 2 Measurement of Termination Resistance

SHEET			AMP (Japan), Ltd. TOKYO, JAPAN
12 OF 13	LOG J A	NO 108-5056	REV E
NAME Product Specification			
AMP MODU MOD IV Interconnection System			

NUMBER
108-5056

CUSTOMER
RELEASE

AMP SECURITY
CLASSIFICATION

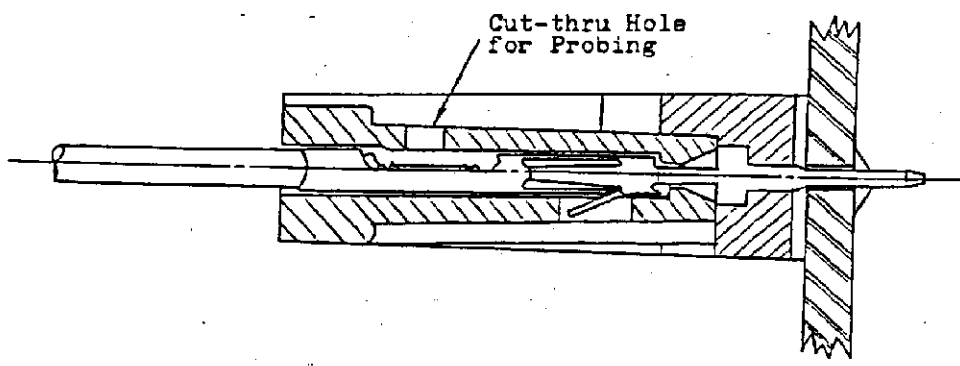



Fig. 3 Measurement of Temperature Rising

SHEET				AMP (Japan), Ltd. TOKYO, JAPAN	
13	OF	13	LOC	NO	REV
			J	A	E
			108-5056		
NAME Product Specification					
AMPMODU MOD IV Interconnection System					

单击下面可查看定价，库存，交付和生命周期等信息

[>>TE Connectivity\(泰科\)](#)