

DESIGN OBJECTIVES

108-5094

"375" Series Fastin-Faston 2 Pos. Connector

In case when "product specification" is referred to in this document, it should be read as "design objectives" for all times as applicable.

1. Scope

This specification covers product performance requirements and test methods of "375" series Fastin-Faston 2 pos. connector of the part numbers shown in Para. 2, manufactured by AMP(Japan), Ltd.

2. Part Numbers and Descriptions

Part Number	Description
171447	2 Pos. Plug Housing
171449	2 Pos. Cap Housing
280074-1, -2	"375" Fastin-Faston Tab
280075-1, -2	..
170268-1, -2	"375" Fastin-Faston Receptacle
170269-1, -2	..
350218-1	Universal MATE-N-LOK Pin
350536-1	Universal MATE-N-LOK Socket

DESIGN OBJECTIVES

The product described in this document has not been fully tested to ensure conformance to the requirements outlined below. Therefore, AMP (Japan), Ltd makes no representation or warranty, express or implied, that the product will comply with these requirements. Further, AMP (Japan), Ltd. may change these requirements based on the results of additional testing and evaluation. Contact AMP Engineering for further details.

						DR : 5 Oct 94 <i>Shindo</i>	Classification : Design Objectives	
C1	Revised RFA-1892	<i>SS</i>	<i>Ko</i>	<i>Ym</i>	<i>10/5 '94</i>	CHK : <i>K. Oda</i>	CODE : 108-5094	REV C1
C	Revised RFA-468							
Rev	Revision Record	D R	CHK	APP	DATE	APP : <i>5 Oct 94</i> <i>M. Matsushita</i>	NAME : "375" Series Fastin-Faston 2 Pos. Connector	
27 September, 1994		PAGE 1 OF 14						

3. Product Feature

This connector consists of two "375" series Fastin-Fastons and one MATE-N-LOK contacts and the housing incorporates a metal locking device. Contacts are retain in the housing by individual housing lances, this assures proper seating of the contacts into the housing cavity.

The MATE-N-LOK contact was developed as a sensor circuit to assure proper seating of the mated connectors. The metal locking device visibly assures proper mating of the connectors. It can be easily disconnected by lifting up on the forward area of the locking device. Refer to Fig. 1 regarding proper mating.

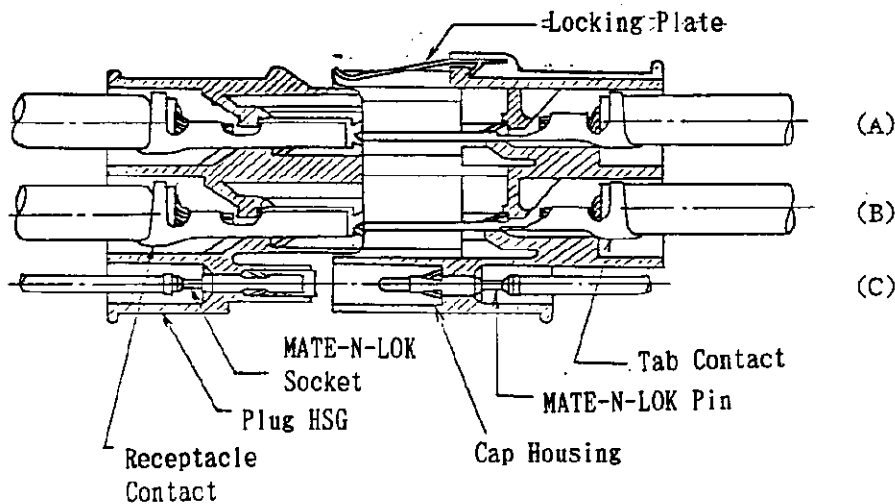

Fig. 1

Combination Circuit	I	II	III	IV	V	VI
A	No Plated Faston	No Plated Faston	Plated Faston	Plated Faston	Plated Faston	No Plated Faston
B	Plated Faston	Plated Faston	No Plated Faston	No Plated Faston	Plated Faston	No Plated Faston
C	MATE-N-LOK	MATE-N-LOK	MATE-N-LOK	-	-	MATE-N-LOK

Classification: Design Objectives	Name: "375" Series Fastin-Faston 2 Pos. Connector	Code: 108-5094	Rev. C 1	Page: 2 of 14
---	---	-------------------	-------------	------------------

4. Definitions of Terms

For the purpose of this specification, the following definitions shall apply.

- 4.1 Contact : An electrically conductive metallic component member of a connector.
- 4.2 Housing : An electrically insulating component member that encapsulates contacts.
- 4.3 Connector : An assembly of wire crimped contacts and housing.

5. Materials

5.1 Contact

Contact shall be made from brass conforming to Alloy No.260 of ASTM B36.

5.2 Housing

Housing shall be made of molded heat-resist 6/6 Nylon resin.

6. Product Feature, Construction and Dimensions

Product features, constructions and Dimensions of contact and housing shall be conforming to the applicable drawings.

7. Operating Conditions

7.1 Temperature Rating

Temperature rating for continuous operating shall be within the range of -30~150°C.

7.2 Applicable Wire Range

Contact Number	Wire size and Application		Insulation Diameter
	mm ²	AWG	
280074-1, -2 170268-1, -2	4.6~9.04	#10~#8	4.6~7mm
280075-1, -2 170269-1, -2	3.08~5.27	#12~#10	3.8~5mm
350218-1 350536-1	0.5~2.27	#20~#14	3.3mmMAX

Classification: Design Objectives	Name: "375" Series Fastin-Faston 2 Pos. Connector	Code: 108-5094	Rev. C1	Page: 3 of 14
---	---	-------------------	------------	------------------

8. Performance

8.1 Performance

Product performance shall be conforming to the requirements specified in Table 1, when tested in accordance with the test methods specified in Para. 8.2 and test sequence specified in Para. 8.3.

Test Items	Test Methods	Performance	
		Initial	After test conditioning
Appearance	Para. 8.2.1	No defects and deficiencies such as breakage, cracks, damages, loose of parts which are detrimental to connector functions shall be evident.	Same as follows
Terminal Resistance	Para. 8.2.2	Not greater than 10mV/A.	Not greater than 20mV/A.
Insulation Resistance	Para. 8.2.3	Not less than 100MΩ	Same as follows
Dielectric Strength	Para. 8.2.4	No abnormalities shall appear after withstanding 1800VAC for 1min.	
Contact Insertion/ Extraction Force	Para. 8.2.5	No Plated Faston : Insertion 5kg Max., Extraction 1kg Min. Plated Faston : Insertion 7kg Max., Extraction 2kg Min.	
Conn. Insertion Force	Para. 8.2.6(1)	15kg Max.	Same as follows
Contact Extraction Force	Para. 8.2.6(2)	3kg Min.	
Handling Touch of Contact Ass'y	Para. 8.2.7	No difficulties of engagement shall be perceptible.	
Contact Retention Force	Para. 8.2.8	10kg Min. 5kg Min. (MATE-N-LOK only)	
Crimp Tensile Strength	Para. 8.2.9	0.5 mm ² : 6.8kg Min.	No Applicable
		0.85mm ² : 9 kg Min.	..
		1.25mm ² : 9 kg Min.	..
		2 mm ² : 15 kg Min.	..
		3 mm ² : 30 kg Min.	..
		5 mm ² : 40 kg Min.	..
Housing Retention Force	Para. 8.2.10	20kg Min.	..
Repeated Insertion/ Extraction	Para. 8.2.11	No Applicable	* 1
High Frequency Vibration	Para. 8.2.12	..	No electrical discontinuity greater than 1 microsecond. And * 1
Physical Shock Resistivity	Para. 8.2.13	..	
Aging Resistivity	Para. 8.2.14	..	* 1
Humidity (Steady State)	Para. 8.2.15		Connector shall meet specified requirements after conditioning.
Salt Spray	Para. 8.2.16		
Oil Resistivity	Para. 8.2.17		
Current Overload	Para. 8.2.18	..	No catching fire

(*)Combination of Insertion and Extraction Force is based on Fig. 1.

Table 1

Classification: Design Objectives	Name: "375" Series Fastin-Faston 2 Pos. Connector	Code: 108-5094	Rev. C 1	Page: 4 of 14
--------------------------------------	---	-------------------	-------------	------------------

8.2 Test Method

8.2.1 Appearance

Appearance shall be inspected by visual and tactile organ.

8.2.2 Termination Resistance

Mated pair of contacts or connector assemblies shall be tested for termination resistance by applying closed circuit current of 1A at open circuit voltage of 12V DC flowing through the circuit. Measurement shall be done at the probing points of Y and Y' across the termination 75mm apart from the wire crimp.

Termination resistance shall be calculated from the measured value after deducting resistance of the 150mm long wire crimped in the circuit.

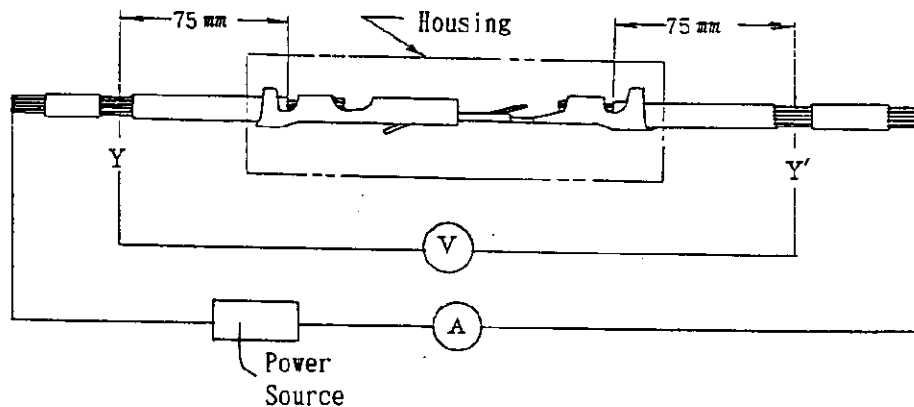

Fig. 2

8.2.3 Insulation Resistance

Insulation resistance of the mated pair of connector assemblies shall be tested by applying test potential of 500V DC between the adjacent contacts and between the contacts and the housing(ground) as shown in Fig. 3.

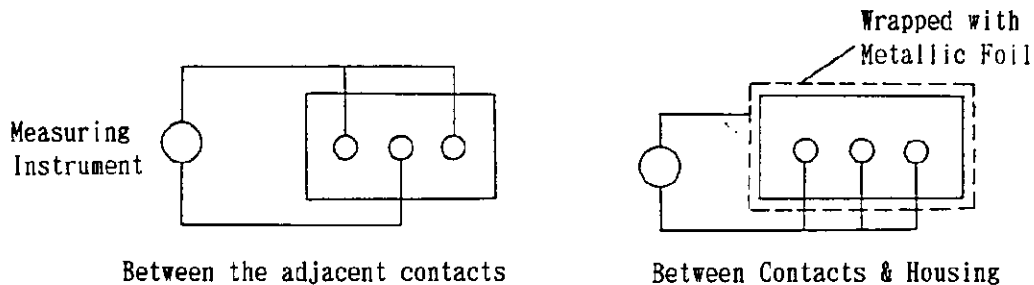

Fig. 3

Classification:
Design
Objectives

Name:
"375" Series Fastin-Faston
2 Pos. Connector

Code:
1 0 8 - 5 0 9 4

Rev. Page:
C 1 5 of 14

8.2.4 Dielectric Strength

Dielectric strength of mated pair of connector assemblies tested by applying test potential of 1,800V AC between the adjacent contacts and between the contacts and the housings(ground)as shown in Fig.3. shall not be appeared no abnormalities.

8.2.5 Contact Insertion/Extraction Force

Fasten one half of mated pair of connector assemblies on the head of tensile testing machine, and operate the head to unmate the counterpart by traveling the head with the speed at a rate of 100mm a minute.

8.2.6(1) Connector Insertion Force

Fasten one half of plug housing and cap housing put in contact on the head of tensile testing machine, and operate the head to mate with the counterpart connector assembly by traveling the head with the speed at a rate of 100mm a minute. For this test, locking device of connector housing must be set in effect.

8.2.6(2) Connector Extraction Force

Fasten one half of plug housing and cap housing put in contact on the head of tensile testing machine, and operate the head to mate with the counterpart connector assembly by traveling the head with the speed at a rate of 100mm a minute. For this test, locking device of connector housing must not be set in effect.

8.2.7 Handling Touch of Contacts at Assembly

Handling touch of contacts shall be tested by repeating insertion and extraction by hand to inspect the feeling tactually at assembly.

8.2.8 Contact Retention Force

Fasten housing assembly that accommodates contacts crimped with approximately 100mm long 5mm² wire on the tensile testing machine, and apply an axial pull-off load to the end of crimped wire by operating the head to travel with the speed at a rate of 100mm a minute. Measure the loaded force at which contact is dislodged. (As for the MATE-N-LOK, the wire is not specified.)

Classification: Design Objectives	Name: "375" Series Fastin-Faston 2 Pos. Connector	Code: 108-5094	Rev. C1	Page: 6 of 14
---	---	-------------------	------------	------------------

8.2.9 Crimp Tensile Strength

Fasten an approximately 100mm long wire-crimped contact to the head of tensile testing machine, and apply an axial load to pull-off the wire by operating the head to travel with the speed at a rate of 100mm a minute. Measure the loaded force at which wire is broken or is pulled out of the wire crimp.

8.2.10 Housing Retention Force

Mate a pair of connector assemblies with the locking device set in effect, and secure one half of them on the tensile testing machine, and apply an axial pull-off load to the counterpart connector assembly by operating the head to travel with the speed at a rate of 100mm a minute. Measure the loaded force at which connector halves are separated or locking device is broken or unlocked.

8.2.11 Repeated Insertion/Extraction

Measure Insertion/Extraction force after securing one half of mated pair of connector assemblies on the testing machine, and repeating insertion and extraction into and from the counterpart connector by operating the machine head to travel with the speed at a rate of 100mm a minute in the axial direction for a total of 10 cycles.

8.2.12 High Frequency Vibration

Contact loaded and mated pair of connector assemblies shall be tested for vibration stability performance with all contacts series wired, by having assemblies securely fastened on the plate of vibration testing machine being arranged as shown in Fig.4. Vibration shall be applied shown as Fig.5, and be monitored for the loss of electrical discontinuity taking place in the circuit.

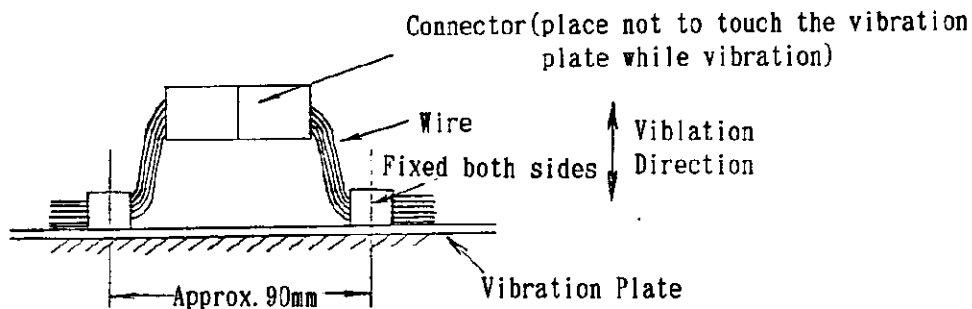

Fig. 4

Classification: Design Objectives	Name: "375" Series Fastin-Faston 2 Pos. Connector	Code: 108-5094	Rev. C1	Page: 7 of 14
---	---	-------------------	------------	------------------

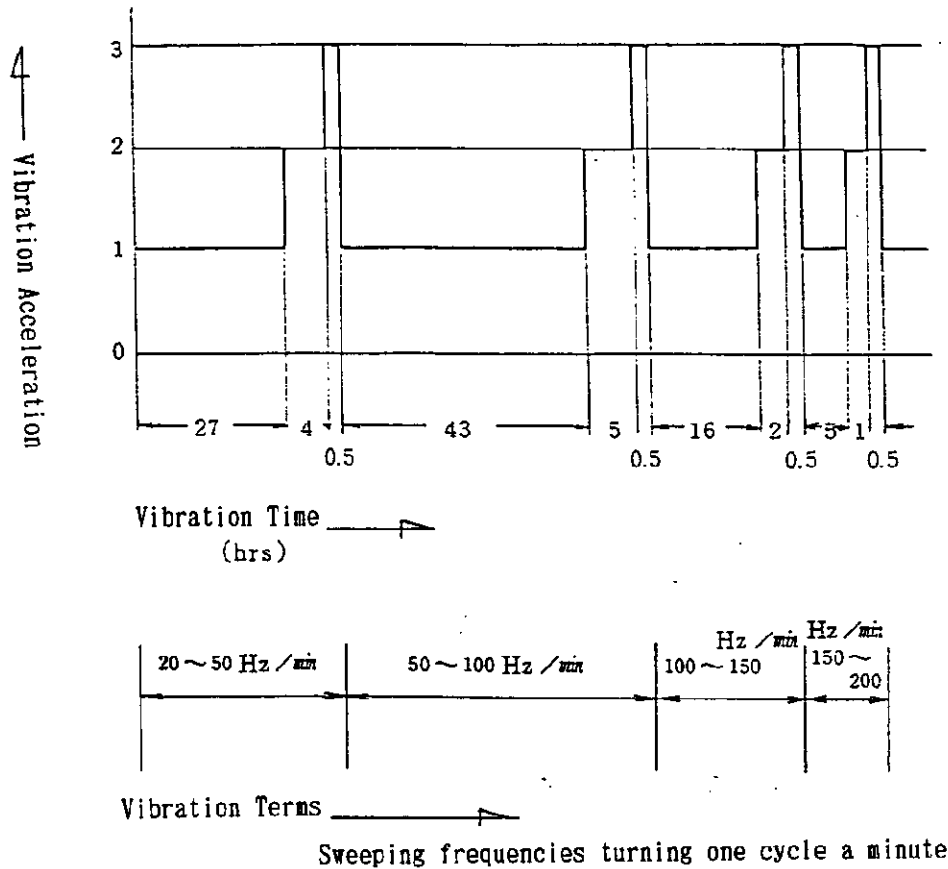

Fig. 5

8.2.13 Physical Shock Resistivity

Contact loaded and mated pair of connector assemblies shall be tested for Physical Shock with all contacts series wired and energized with closed circuit test current of 1A at open circuit voltage of 12V DC flowing through the circuit on the vibration testing machine as shown in Fig. 4. Applied JIS D5500 item 6.6, Physical Shock shall be given for 1 hour and during the test, the test circuit shall be monitored for the loss of electrical discontinuity taking place in the circuit.

Classification: Design Objectives	Name: "375" Series Fastin-Faston 2 Pos. Connector	Code: 108-5094	Rev. C1	Page: 8 of 14
---	---	-------------------	------------	------------------

8.2.14 Aging Resistivity

Contact-loaded and mated pair of connector assembly shall be subject to exposure under heat/cold environmental test conditions for 5 cycles totally, at a rate one cycle a day, in accordance with the test sequence specified in Table.2, except Step 5 omitted in 5th cycle only.

From 1st to 4th cycles the sample connetor assemblies shall be dried at room temperature shown in fig.6 after Step 5.

Step	Test Procedure
1	Expose under air at $-30 \pm 5^{\circ}\text{C}$ for 3 hours
2	Recondition in room temperature for 30 minutes
3	Expose under air at $150 \pm 5^{\circ}\text{C}$ for 3 hours
4	Recondition in room temperature for 30 minutes
5	Immerse in water at $20 \pm 5^{\circ}\text{C}$ for 1 minute

Table 2

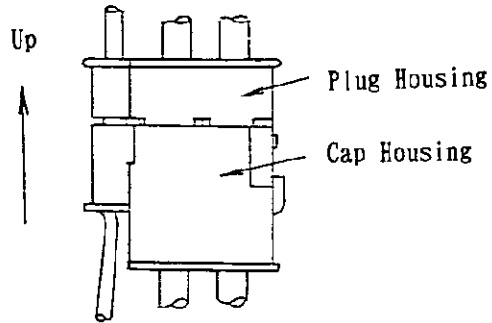

Fig. 6

8.2.15 Humidity (Steady State)

Contact-loaded and mated pair of connector assemblies shall be subject to humidity conditioning shown in Fig.8 with test potential of 28V DC applied between the adjacent contacts in test chamber where test temperature at $60 \pm 5^{\circ}\text{C}$ in relative humidity ranging between 90 and 95% is maintained. After exposing for 48 hours, sample connector shall be reconditioned in the room temperature.

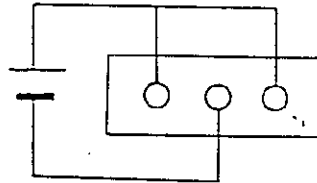

Fig. 7

Classification: Design Objectives	Name: "375" Series Fastin-Faston 2 Pos. Connector	Code: 1 0 8 - 5 0 9 4	Rev. C 1	Page: 9 of 14
---	---	--------------------------	-------------	------------------

8.2.16 Salt Spray

Contact-loaded and mated pair of connector assemblies hung in the sealed tank shall be subject to salt spray conditioning in accordance with JIS C 5028, by exposing under salt spray for 2 cycles, each consisting of 24 hours with 1 hour interval taking between the cycles. After completion of conditioning, sample connector assemblies shall be rinsed in tap water and dried in the room temperature.

8.2.17 Oil Resistivity

Contact-loaded and mated pair of connector assemblies shall be subject to immerse in engine oil (SAE 10W) or the same quality of engine oil and Kerosene (JIS K 2203-2) maintained at $50 \pm 2^\circ\text{C}$ during immersion for two hours. After immersion, sample connector assemblies shall be reconditioned in the room temperature.

8.2.18 Current Overload

Contact loaded and mated pair of connector assemblies with all contacts series wired shall be carefully observed applying direct current for two minutes shown in Table 3. Only for MATE-N-LOK contact, current should not be applied.

Wire Size	Overload Test Current
3mm ²	54A
5mm ²	74A
8mm ²	94A

Table 3

Classification: Design Objectives	Name: "375" Series Fastin-Faston 2 Pos. Connector	Code: 108-5094	Rev. C1	Page: 10of14
---	---	-------------------	------------	-----------------

8.3 Test Sequence

All the tests shall be conducted in accordance with the test sequence specified in Table 4.

		Test Sequence										
Test Items	Test Method	I	II	III	IV	V	VI	VII	VIII	IX	X	XI
Appearance	Para. 8.2.1	1			5	5	5	5	5	5	5	
Terminal Resistance	Para. 8.2.2	3				2	2	2	2	2	2	
Insulation Resistance	Para. 8.2.3	4						6	6	6	6	
Dielectric Strength	Para. 8.2.4	5						7	7	7	7	
Contact Insertion/Extraction Force	Para. 8.2.5		1									
Contact Insertion Force	Para. 8.2.6(1)	2			2							
Contact Extraction Force	Para. 8.2.6(2)	6			3	3	3	3	3	3	3	
Handling Touch of Contact Assy	Para. 8.2.7	7			4	4	4	4	4	4	4	
Contact Retention Force	Para. 8.2.8	9				6	6	8	8	8	8	
Crimp Tensile Strength	Para. 8.2.9			1								
Housing Retention Force	Para. 8.2.10	8										
Repeated Insertion Extraction	Para. 8.2.11				1							
High Frequency Vibration	Para. 8.2.12					1						
Physical shock Resistivity	Para. 8.2.13						1					
Aging Resistivity	Para. 8.2.14							1				
Humidity(Steady State)	Para. 8.2.15								1			
Salt Spray	Para. 8.2.16									1		
Oil Resistivity	Para. 8.2.17										1	
Current Overload	Para. 8.2.18											1

Table 4

Classification: Design Objectives	Name: "375" Series Fastin-Faston 2 Pos. Connector	Code: 108-5094	Rev. C1	Page: 11of14
---	---	-------------------	------------	-----------------

9. Quality Assurance Provisions

9.1 Test Conditions

Unless otherwise specified, all the tests shall be conducted in any combination of the following test conditions.

Temperature : 15~35°C

Relative Humidity : 45~75%

Atmospheric Pressure : 650~800mmHg

9.2 Sample Preparation

9.2.1 Specimens

The sample pieces used for the performance tests in accordance with this specification shall be prepared by using the wires specified in Table 5 and by the procedure conforming to 114-5007, Application Specification, Crimping "375" Series Fastin-Faston Connector, and 114-5008, Application Specification Crimping MATE-N-LOK Contact for Universal MATE-N-LOK Connector.

No sample pieces are allowed for use of test other than specified.

9.2.2 Number of Specimens

Each sample group used for the specified performance tests, shall consists of not less than 10 sets of contacts and not less than 2 sets of connector assemblies.

Classification: Design Objectives	Name: "375" Series Fastin-Faston 2 Pos. Connector	Code: 108-5094	Rev. C1	Page: 12of14
---	---	-------------------	------------	-----------------

9.2.3 Applicable Wire Sizes

The wires used for the tests shall be conforming to the requirements specified in Table 5.

Wire Size		Strand Composition		Calculated Cross Sectional Area	
mm ²	AWG	Diameter of a Strand (mm)	No. of Strands	mm ²	CMA
0.5	#20	0.32	7	0.56	1111
0.85	#18	0.32	11	0.88	1746
1.25	#16	0.32	16	1.28	2540
2	#14	0.32	26	2.09	4128
3	#12	0.32	41	3.3	6509
5	#10	0.32	65	5.23	10319
8	# 8	0.45	50	7.95	15695

Table 5

10. Workmanship at Assembly

10.1 Crimping Contact

Crimped contact shall have optimum performance characteristics, performed in accordance with the procedure specified in 114-5007, Application Specification, Crimping "375" Series Fastin-Faston Connector, and 114-5008, Application Specification, Crimping MATE-N-LOK contact for universal MATE-N-LOK Connector.

10.2 Seating Orientation of Contacts in Housing Cavities

In order to maintain proper mating acceptability between the male and female contacts, and stable performance of the connector assemblies, all the contacts shall be accommodated in the cavities in the correct seating orientation as shown in Fig. 8.

Classification: Design Objectives	Name: "375" Series Fastin-Faston 2 Pos. Connector	Code: 108-5094	Rev. C 1	Page: 13of14
---	---	-------------------	-------------	-----------------

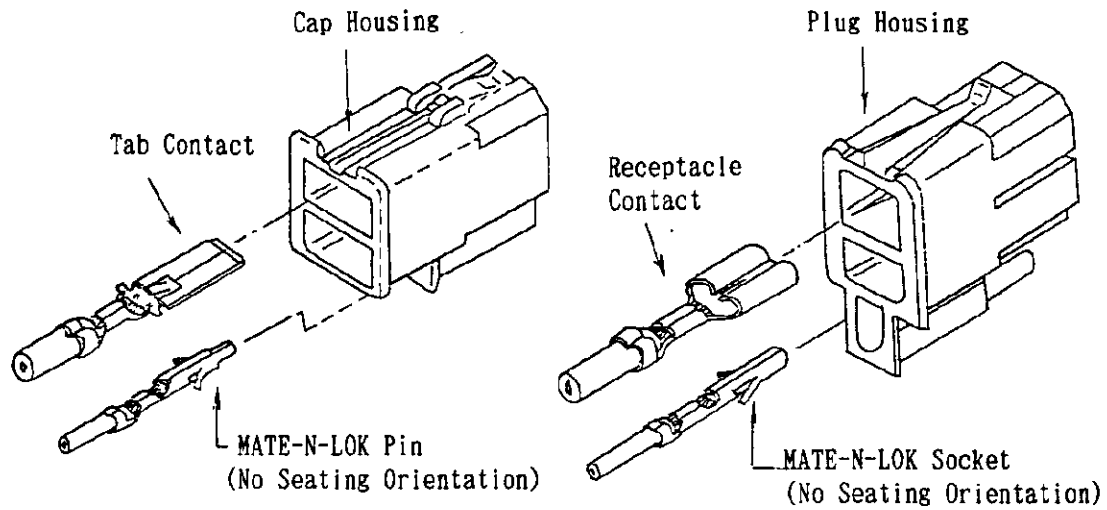

Fig. 8

10.3 Application Tooling

For crimping contacts and extraction of contacts from housing, AMP specified appropriate application tooling shall be used in accordance with proper instruction sheets attached to the hand tools.

11. Applicable Documents for Specification

- JASO D 605 Automotive Multi-pole Connector
- JIS C 3406 Low Voltage Cables for Automobiles
- JIS C 5028 Salt Mist Testing Method for Electronic Component
- JIS D 5500 Lighting and Signalling Equipment for Automobiles

Classification: Design Objectives	Name: "375" Series Fastin-Faston 2 Pos. Connector	Code: 108-5094	Rev. C 1	Page: 14of14
---	---	-------------------	-------------	-----------------

单击下面可查看定价，库存，交付和生命周期等信息

[>>TE Connectivity\(泰科\)](#)