

DESIGN OBJECTIVES

The product described in this document has not been fully tested to ensure conformance to the requirements outlined below. Therefore, AMP (Japan), Ltd makes no representation or warranty, express or implied, that the product will comply with these requirements. Further, AMP (Japan), Ltd. may change these requirements based on the results of additional testing and evaluation. Contact AMP Engineering for further details.

1. SCOPE

In case when "product specification" is referred to in this document, it should be read as "design objectives" for all times as applicable.

This specification applies to the 2-position Receptacle Contact and Pin Receptacle Housing (hereinafter referred to as housing) to be mated to a pin on a printed circuit board (PCB).

Product Name	Product No.	Remarks
Receptacle Contact	170073-5	AWG #24 ~ #20
Receptacle Housing	174315	2 positions

2. MATERIALS USED AND SURFACE TREATMENT

Product Name	Materials Used and Surface Treatment
Receptacle Contact	Tin plated (more than 0.8 μm) brass
Receptacle Housing	Nylon (UL94-V2)

3. RATINGS

No.	Item	Rating
3.1	Voltage Rating	250V AC and DC
3.2	Current Rating	Depends on terminating wire size as follows. AWG #24 ... 5.5A AWG #22 ... 6.5A AWG #20 ... 8.5A
3.3	Operating Temperature	-30°C ~ +105°C Upper limit temperature includes temperature rising due to application of load current.
3.4	Applicable Wire Size	0.20 ~ 0.56 mm ² (AWG24 ~ 20)
3.5	Applicable Pin Pitch	5.0 ~ 7.0 mm

							AMP (Japan), Ltd. TOKYO, JAPAN	
A1	Design Objectives RFA 1905	Y.M	ZAFEB 95	19/9 87	CHK	LOC	NO	REV
A	Revised RFA-1076	10/18 87	10/18 87	APP	J	A	108-5237	A1
0	Released RFA-1070	10/1 86	10/1 86	NAME	2-POSITIONED PIN RECEPTACLE HOUSING FOR 2.36φ PIN			
LTR	REVISION RECORD	DR	CHK	DATE	SHEET			
					1 OF 7			

4. QUALITY ASSURANCE PROVISIONS

4.1 Test Condition

Unless otherwise specified, all the tests shall be performed under any combination of the following test conditions.

Temperature : 15 ~ 35°C

Relative Humidity : 45 ~ 75%

Atmospheric Pressure : 650 ~ 800 mmHg

4.2 Test Specimens

4.2.1 All the specimens to be employed for the tests shall conform to the applicable product drawing(s).

4.2.2 The wires used for termination shall conform to the requirements specified in Para. 3.4 and 3.5 and terminated by applicable application tools.

4.2.3 Unless otherwise specified, no sample shall be reused for the test.

5. PERFORMANCE REQUIREMENTS

Item	Test Item	Standard Requirement	Test Conditions and Method
5.1	Appearance	There shall be no scratch, crack, deformation, blister, fouling, burr, etc. significantly detrimental to the functions and commercial value of the contact.	Visual
5.2	Low-level Termination Resistance	Initial: 10 mΩ max.	Measure the circuit shown in Fig. 2 by applying closed circuit test current of 10 mA max. at open circuit voltage of 20 mV DC max.
5.3	Insulation Resistance	1000 MΩ min.	Test per Condition B, Test Method 302, MIL-STD-202 by applying 500V±10% between adjacent contacts or between the contact and the earth of the mated pair of connectors.

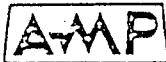
SHEET			AMP (Japan), Ltd. TOKYO, JAPAN	
<u>2</u> OF <u>7</u>	LOC J	A	NO 108-5237	REV. A1
NAME 2-POSITIONED PIN RECEPTACLE HOUSING FOR 2.36φ PIN				

Item	Test Item	Standard Requirement		Test Conditions and Method	
5.4	Dielectric Strength	After testing, no abnormalities such as insulation breakdown or flashover shall be evident.		Test per Test Method 301, MIL-STD-202 by applying AC 1000V (RMS) between the adjacent contacts of the mated pair of connectors for 1 minute. The pin assembly shall be tested without mounting on the PCB.	
5.5	Crimp Tensile Strength	Wire Size		Each specimen shall have an applicable wire approximately 100 mm long crimped, and the crimp tensile strength shall be measured by pulling it in the direction of its working axis at a speed of 100 mm/min. A minimum tensile load causing the wire to snap or come off from the contact shall be taken as the crimp tensile strength. No insulated area of the wire shall be crimped.	
		mm 2	AWG		Tensile Strength Kg (min.)
		0.2	#24		3
		0.3	#22		5
		0.5	#20	8	
5.6	Contact Retention Force	4.0 Kg min.		The contact having applicable wire whose tensile strength is greater than the specified requirement crimped shall be placed in the housing. Pull the contact in axial direction at a rate of 100 mm/min. and measure the minimum load required to dislodge the contact from the housing.	
5.7	Contact Loading Force	2.0 Kg max.		Measure the force required to insert the crimped contact in the housing.	

SHEET			AMP (Japan), Ltd. TOKYO, JAPAN	
3 OF 7	LOC	NO	108-5237	REV. A1
NAME 2-POSITIONED PIN RECEPTACLE HOUSING FOR 2.36φ PIN				

Item	Test Item	Standard Requirement			Test Conditions and Method
5.8	Connector Insertion/Extraction Force	Insertion Force Kg max.	Extraction Force Kg min.		Insert/extract the pin assemblies having as many positions as the receptacle assemblies at a rate of 100 mm/min. and measure the initial insertion/extraction forces and extraction force after repeating insertion/extraction 10 times.
		Initial	Initial	After extracted 10 times	
		4.0	0.3	0.2	
5.9	Durability	No problem tolerated in appearance Low-level Termination Resistance: 20 mΩ max.			Insert/extract the pin assembly having as many positions as the receptacle assembly 6 times at a rate not exceeding 5 times/30 sec.
5.10	Humidity Resistance (Steady State)	Insulation Resistance: 100 mΩ min. Dielectric Strength: To meet Para. 5.4 Low-level Termination Resistance: 20 mΩ max.			Test per Test Method 103, MIL-STD-202 for 96 hours with the receptacle assembly engaged to the pin assembly mounted on the PCB. Temperature: 40±2°C Humidity: 90 ~ 95% Take measurement after sitting the specimen for one hour at room temperature after the test.
5.11	Heat Shock	Low-level Termination Resistance: 20 mΩ max.			Test 25 cycles on end per Test Method 107, MIL-STD-202 with the receptacle assembly mated to the pin assembly mounted on the PCB.
		Step	Temperature (°C)	Duration (min.)	
		1	-55	30	
		2	+25	5 max.	
		3	+85	30	
4	+25	5 max.			

SHEET			AMP (Japan), Ltd. TOKYO, JAPAN	
4 OF 7	LOG J	A	NO 108-5237	REV. A1
NAME 2-POSITIONED PIN RECEPTACLE HOUSING FOR 2.36φ PIN				

Item	Test Item	Standard Requirement	Test Conditions and Method
5.12	Heat Resistivity	Low-level Termination Resistance: 20 mΩ max.	Test for 96 hours with the receptacle assembly mated to the pin assembly mounted on the PCB. Temperature: 80±3°C Take measurement after sitting the specimen for one hour at room temperature after the test.

6. TEST ITEMS AND SEQUENCE

The performance shall be tested according to the test groups and sequence of tests listed below.

Test Item	No.	Test Group								
		A	B	C	D	E	F	G	H	I
Appearance	5.1	1					1	1	1	1
Low-level Termination Resistance	5.2						2	2	2	2
Insulation Resistance	5.3	2								
Dielectric Strength	5.4	3								
Crimp Tensile Strength	5.5		1							
Contact Retention Force	5.6			1						
Contact Loading Force	5.7				1					
Connector Insertion/Extraction Force	5.8					1				
Durability	5.9						3			
Humidity Resistivity	5.10	4						3		
Heat Shock	5.11								3	
Heat Resistivity	5.12									3
Insulation Resistance	5.3	5								
Dielectric Strength	5.4	6								
Low-level Termination Resistance	5.2						4	4	4	4
Appearance	5.1	7					5	5	5	5

Fig1.

SHEET			AMP (Japan), Ltd. TOKYO, JAPAN	
5 OF 7	LOC J	NO A	108-5237	REV. A1
NAME 2-POSITIONED PIN RECEPTACLE HOUSING FOR 2.36φ PIN				

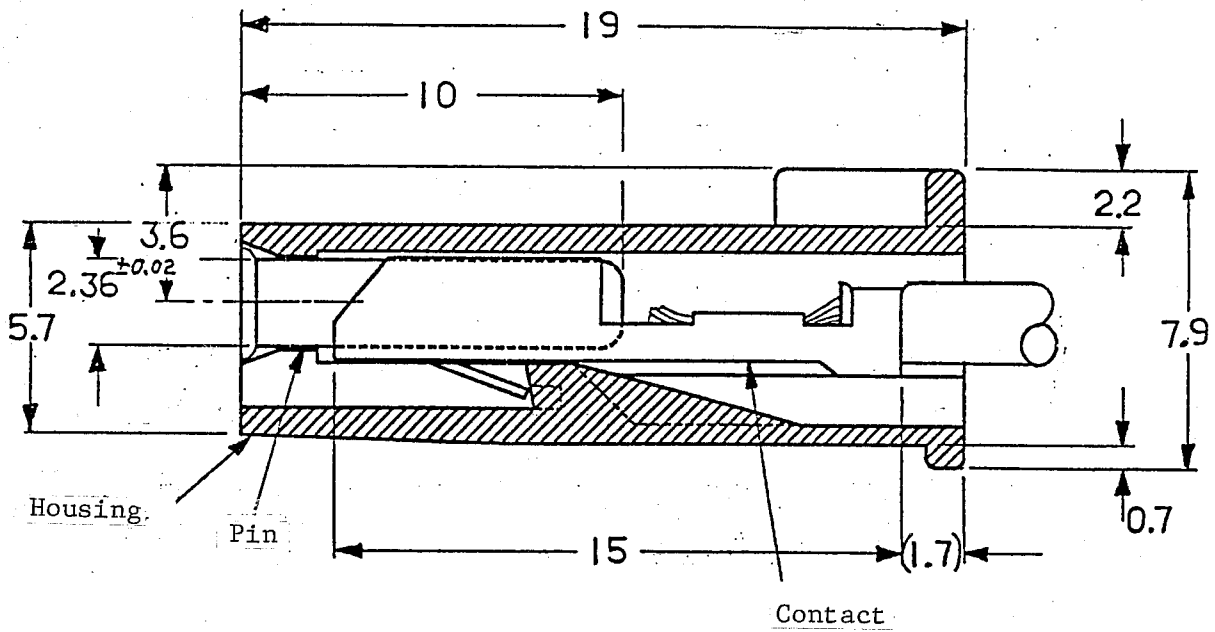
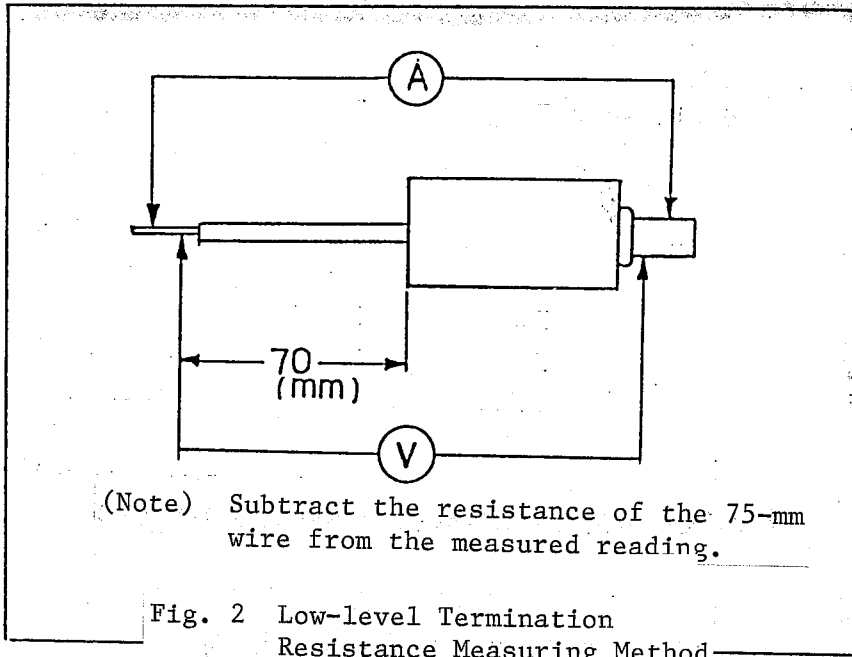
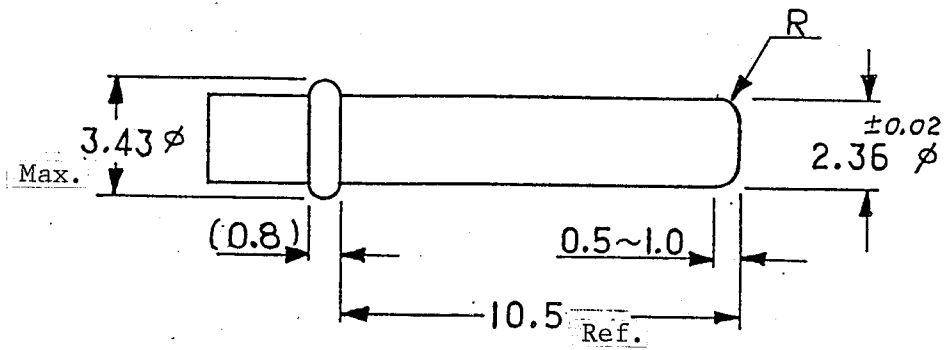

Fig. 3 Cross Sectional Drawing

SHEET	AMP		AMP (Japan), Ltd. TOKYO, JAPAN	
6 OF 7	LOG J	A	NO 108-5237	REV. A1
NAME 2-POSITIONED PIN RECEPTACLE HOUSING FOR 2.36φ PIN				



Extrusion molded brass with uniform nickel plating on surface

Applicable Pin

SHEET			AMP (Japan), Ltd. TOKYO, JAPAN	
7 OF 7	LOC J	A	NO 108-5237	REV. A1
NAME	2-POSITIONED PIN RECEPTACLE HOUSING FOR 2.36ø PIN			

单击下面可查看定价，库存，交付和生命周期等信息

[>>TE Connectivity\(泰科\)](#)