

108-5252-1

Product Specification

110 Series, Positive Lock Connector

1. Scope:

This specification covers the requirements for product performance and test methods of 110 Series, Positive Lock Connectors of the following part numbers.

| Part Number | Product Descriptions |
|-------------|--|
| X-174777-X | Receptacle Contact, (Strip Form) |
| X-175411-X | " " " " |
| X-174778-X | Receptacle Contact, (Loose Piece Form) |
| X-175412-X | " " " " " |
| X-174779-X | 1-Position, Positive Lock Housing |
| X-178832-X | 3-Position, Positive Lock Housing |

2. Material and Finish:

Contact: Pretinned (0.8 μ m min. thick), Brass

Housing: Molded 6/6 Nylon Resin

3. Rating:

3.1 Voltage Rating: 250V AC or DC

3.2 Current Rating: Rating varies depending upon the wire size terminated as shown below.

| | | | |
|-------------------------------|------|--------------------------------|-------|
| AWG #24 (0.2mm ²) | 2.5A | AWG #18 (0.75mm ²) | 7.0A |
| AWG #22 (0.3mm ²) | 3.0A | AWG #16 (1.25mm ²) | 12.0A |
| AWG #20 (0.5mm ²) | 5.0A | | |

3.3 Temperature Rating: -40°C thru +105°C (Temperature rise due to energizing is inclusive.)

3.4 Applicable Wires:

| Wire Size | Part Numbers | X-174777-X X-174778-X | X-175411-X X-175412-X |
|-------------------------|-----------------------------|--------------------------|--------------------------|
| | Wire Size(mm ²) | | 0.5 - 1.25 |
| Insulation Diameter(mm) | | 2.03 - 3.1 | 1.02 - 1.78 |

108-5252-1

Restricted to
Matsushita Denki

AMP SECURITY
CLASSIFICATION

PART LIST

| | | | | | | | | | | | | |
|---------------------|--|--|--|--------------------------------|---|-----|----------------------------------|--------|---|-------------------------------------|------------|-----|
| | | | | DR <i>Ch. Sugita</i> 8/191 |  | | AMP, Japan, Ltd. TOKYO, JAPAN | | | | | |
| | | | | CHK | | | LOC | J | A | NO | 108-5252-1 | REV |
| | | | | APP <i>Y. Fujita</i> 19/191 | | | | | | | | |
| O Released RFA-1888 | | | | <i>AKS</i> 4/9/80 | SHEET | | Product Specification | | | | | |
| LTR | | | | REVISION RECORD | DR | CHK | DATE | 1 OF 7 | | 110 Series, Positive Lock Connector | | |

AMP-1522

4. Product Performance Requirements and Test Methods:

| Test Items | Specified Requirements | Test Methods | | | | | | | | | | | | | | | | | | |
|--|---|--|-------|------------------------------|-----|-------|------|-----|-------|------|-----|-------|------|------|-------|-------|------|-------|-------|--|
| Appearance: Para. 4.1 | Product shall be free from the defects such as flaws, cracks, deformation, blister, dirt and burrs that are remarkably detrimental to connector functions and merchandising value. | Visually inspected. | | | | | | | | | | | | | | | | | | |
| Crimp Tensile Strength: Para. 4.2 | <table border="1"> <thead> <tr> <th>Wire Size mm²</th> <th>(AWG)</th> <th>Tensile Strength (N) min.</th> </tr> </thead> <tbody> <tr> <td>0.2</td> <td>(#24)</td> <td>19.6</td> </tr> <tr> <td>0.3</td> <td>(#22)</td> <td>49.0</td> </tr> <tr> <td>0.5</td> <td>(#20)</td> <td>78.4</td> </tr> <tr> <td>0.75</td> <td>(#18)</td> <td>117.6</td> </tr> <tr> <td>1.25</td> <td>(#16)</td> <td>147.1</td> </tr> </tbody> </table> | Wire Size mm ² | (AWG) | Tensile Strength (N) min. | 0.2 | (#24) | 19.6 | 0.3 | (#22) | 49.0 | 0.5 | (#20) | 78.4 | 0.75 | (#18) | 117.6 | 1.25 | (#16) | 147.1 | Apply an axial pull-off load to the crimped wire of 100mm long approx., by operating the head to travel at a rate of 100mm a minute. The force required to pull-off the wire from the wire crimp determines the tensile strength. For this test, insulation crimp is not included. |
| Wire Size mm ² | (AWG) | Tensile Strength (N) min. | | | | | | | | | | | | | | | | | | |
| 0.2 | (#24) | 19.6 | | | | | | | | | | | | | | | | | | |
| 0.3 | (#22) | 49.0 | | | | | | | | | | | | | | | | | | |
| 0.5 | (#20) | 78.4 | | | | | | | | | | | | | | | | | | |
| 0.75 | (#18) | 117.6 | | | | | | | | | | | | | | | | | | |
| 1.25 | (#16) | 147.1 | | | | | | | | | | | | | | | | | | |
| Contact Locking Strength: Para. 4.3 | 49.0N min. (Initial) | Apply an axial pull-off load to 1.25mm ² (#16 AWG), 100mm approx. long crimped wire, after having the contact mated with tab contact, and with the locking device set in effect with tab side secured on the testing machine, by operating the head to travel at a rate of 100mm a minute. The contact disengagement with or without break-off of locking leg, determines the contact locking strength. | | | | | | | | | | | | | | | | | | |
| Contact Retention Force Para. 4.4 | 49.0N min. | Apply an axial pull-off load to 1.25mm ² (#16 AWG), 100mm approx. long crimped wire after having the contact loaded in housing, and have it secured on testing machine, by operating the head to travel at a rate of 100mm a minute. The force required to dislodge the contact from housing determines the contact retention force. | | | | | | | | | | | | | | | | | | |

(To be continued)

| | | | | |
|-------------------------------------|------------|----|----------------------------------|-----------|
| SHEET | AMP | | AMP (Japan) Ltd. TOKYO, JAPAN | |
| <u>2</u> OF <u>7</u> | LOC | NO | 108-5252-1 | REV. 0 |
| NAME Product Specification | | | | |
| 110 Series, Positive Lock Connector | | | | |

AMP SECURITY CLASSIFICATION Restricted to NUMBER 108-5252-1 Matsushita Denki

(Continued)

| Test Items | Specified Requirements | Test Methods |
|--|--|---|
| Contact Insertion/ Extraction Force: Para. 4.5.1 | Insertion Force: 29.4 N max. Extraction Force: (Initial) 7.8 N min. (6th. Cycle) 2.9 N min. | Fasten mated pair of tab and receptacle contact on tensile tester with tab side secured on the machine, and apply push-in and pull off load by operating the head at a rate of 100mm a minute. The force required to insert and extract the contact shall be measured and recorded. For extraction test, contact locking device shall be not set in effect. |
| Connector Insertion/ Extraction Force: Para. 4.5.2 | 3Pos. Insertion Force: 49.0 N max. Extraction Force: (Initial) 19.6 N min. | |
| Temperature Rising: Para. 4.6 | 30°C max. | Apply rated current to the applicable wire-crimped contact circuit with thermocouple probe attached to the contact. Measure the temperature rise of the contact, after the temperature becomes stabilized. Deduct the room temperature from the measured value. |
| Termination Resistance: (Low Level) Para. 4.7 | (Initial) 3mΩ max. (Final) 6mΩ max. | Measure the millivolt drop of the test circuit as shown in Fig. 1, by using the open circuit voltage of 50mV max. and closed circuit current of 50 mA max. Obtain termination resistance by calculating the measured value. |
| Vibration, Low Frequency: Para. 4.8 | No electrical discontinuity greater than 1 μsec. shall take place during the test. Final termination resistance (low level) shall be 6mΩ max. | Test in accordance with MIL-STD-202, Method 201 as shown in Fig. 2, using the following parameters. Sweeping vibration to reciprocate 10-55-10 Hz, one cycle a minute, Amplitude: 1.5mm both sides Duration: 2 hours each for X and Y directions, Test current: 0.1A (DC) |
| Humidity: Para. 4.9 | Final termination resistance (low level) shall be 6mΩ max. | Test mated connectors in accordance with MIL-STD-202, Method 103, using the following parameters. Temperature: 40°C Relative Humidity: 90-95% Duration: 96 hours |

(To be continued)

| | | | | |
|--|------------|---------|-----------------------------------|-----------|
| SHEET | AMP | | AMP (Japan), Ltd. TOKYO, JAPAN | |
| <u>3</u> OF <u>7</u> | LOC J | NO A | NO 108-5252-1 | REV. 0 |
| NAME Product Specifications 110 Series, Positive Lock Connector | | | | |

(Continued)

| Test Items | Specified Requirements | Test Methods | | | | | | | | | | | | | | | |
|------------------------------|--|---|------|--------------|-----------|---|---|---------|----|------------------|------------|----|---|---------|----|------------------|------------|
| Thermal Shock: Para. 4.10 | Final termination resistance (low level) shall be 6mΩ max. | Test the mated pair of connectors in accordance with MIL-STD-202, Method 107 for 5 cycles in the following procedure. 1 cycle consisting of: <table border="1"><thead><tr><th>Step</th><th>Temperature:</th><th>Duration:</th></tr></thead><tbody><tr><td>1</td><td>105 $\begin{smallmatrix} +3 \\ -0 \end{smallmatrix}$ °C</td><td>30 min.</td></tr><tr><td>2.</td><td>Room Temperature</td><td>5 min.max.</td></tr><tr><td>3.</td><td>-40°C $\begin{smallmatrix} +0 \\ -3 \end{smallmatrix}$ °C</td><td>30 min.</td></tr><tr><td>4.</td><td>Room Temperature</td><td>5 min.max.</td></tr></tbody></table> | Step | Temperature: | Duration: | 1 | 105 $\begin{smallmatrix} +3 \\ -0 \end{smallmatrix}$ °C | 30 min. | 2. | Room Temperature | 5 min.max. | 3. | -40°C $\begin{smallmatrix} +0 \\ -3 \end{smallmatrix}$ °C | 30 min. | 4. | Room Temperature | 5 min.max. |
| Step | Temperature: | Duration: | | | | | | | | | | | | | | | |
| 1 | 105 $\begin{smallmatrix} +3 \\ -0 \end{smallmatrix}$ °C | 30 min. | | | | | | | | | | | | | | | |
| 2. | Room Temperature | 5 min.max. | | | | | | | | | | | | | | | |
| 3. | -40°C $\begin{smallmatrix} +0 \\ -3 \end{smallmatrix}$ °C | 30 min. | | | | | | | | | | | | | | | |
| 4. | Room Temperature | 5 min.max. | | | | | | | | | | | | | | | |
| Salt Spray: Para. 4.11 | Final termination resistance shall be 6mΩ max. | Test the mated pair of connectors in accordance with MIL-STD-202, Method 101 using the following procedure. Salt Concentration: 5% Temperature: 35 °C Duration: 96 hours After completion of test duration, have the samples rinsed in tap water and dried in room temperature without powered ventilation for 1 hour. Then, measure termination resistance. | | | | | | | | | | | | | | | |

5. Quality Assurance Provisions:

5.1 Test Conditions:

Unless otherwise specified, all the tests shall be tested in any combination of the following test conditions.

Temperature: 15 - 35°C
Relative Humidity: 45 - 75%
Atmospheric Pressure: 86.6 - 106.6 KPa

5.2 Test specimens:

The test specimens to be employed for the tests shall be conforming to the applicable product drawing(s), and crimped on the wires specified in Para. 3.4 according to the specified procedure.
No samples shall be reused for the test, unless otherwise specified.

| | | | | |
|-------------------------------------|---|----|-----------------------------------|------|
| SHEET |  | | AMP (Japan), Ltd. TOKYO, JAPAN | |
| 4 OF 7 | LOC | NO | 108-5252-1 | REV. |
| | J | A | | 0 |
| NAME Product Specification | | | | |
| 110 Series, Positive Lock Connector | | | | |

6. Test Sequence:

Product performance testing shall be performed in the sequence as specified in the table below.

| para-graph No. | Test Items | Test Sequence | | | | | | |
|----------------|--|---------------|---|---|---|---|---|------------|
| | | A | B | C | D | E | F | G |
| 4.1 | Appearance | | | | | | | 1 |
| 4.2 | Crimp Tensile Strength | 1 | | | | | | |
| 4.3 | Contact Retention Force | | 1 | | | | | |
| 4.4 | Contact Locking Strength | | | 1 | | | | |
| 4.5.1 | Contact Insertion/ Extraction Force | | | | 1 | | | |
| 4.5.2 | Connector Insertion/ Extraction Force | | | | | 1 | | |
| 4.6 | Temperature Rising | | | | | | 1 | |
| 4.7 | Termination Resistance (Low Level) | | | | | | | 2,4,6,8,10 |
| 4.8 | Vibration, Low Frequency | | | | | | | 3 |
| 4.9 | Humidity | | | | | | | 5 |
| 4.10 | Thermal Shock | | | | | | | 7 |
| 4.11 | Salt Spray | | | | | | | 9 |

7. Mating Tab:

The mating counterpart tab should have the recommended dimensions specified in Fig. 3.

| | | | | |
|--|------------|---|-----------------------------------|-----------|
| SHEET | AMP | | AMP (Japan), Ltd. TOKYO, JAPAN | |
| <u>5 OF 7</u> | LOC J | A | NO 108-5252-1 | REV. 0 |
| NAME Product Specification 110 Series, Positive Lock Connector | | | | |

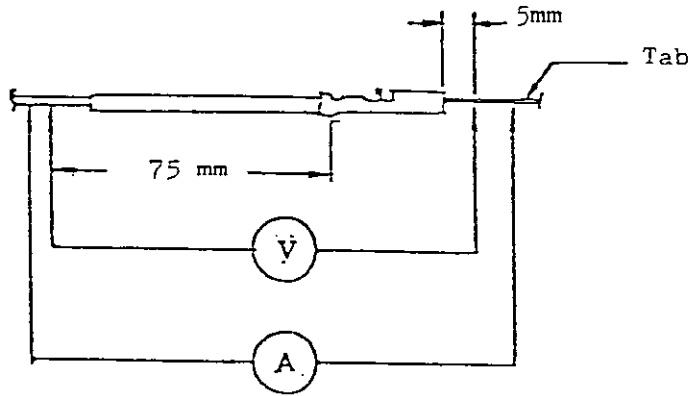

Fig. 1 Termination Resistance (Low Level)
Measuring Method

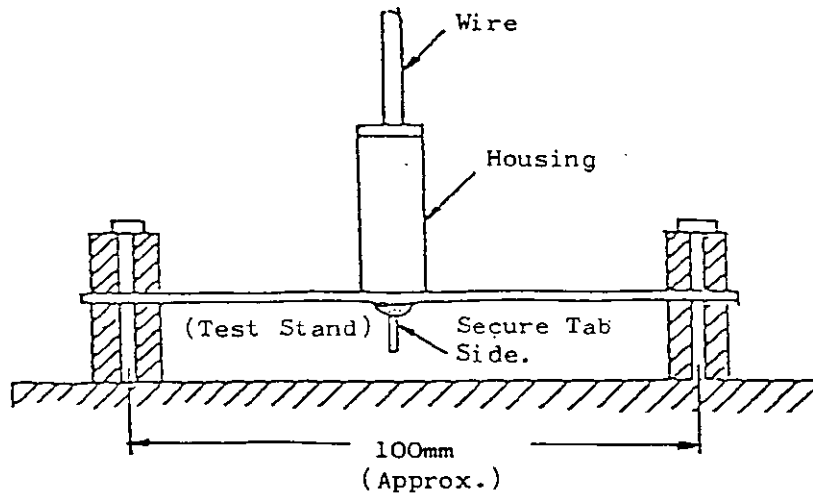
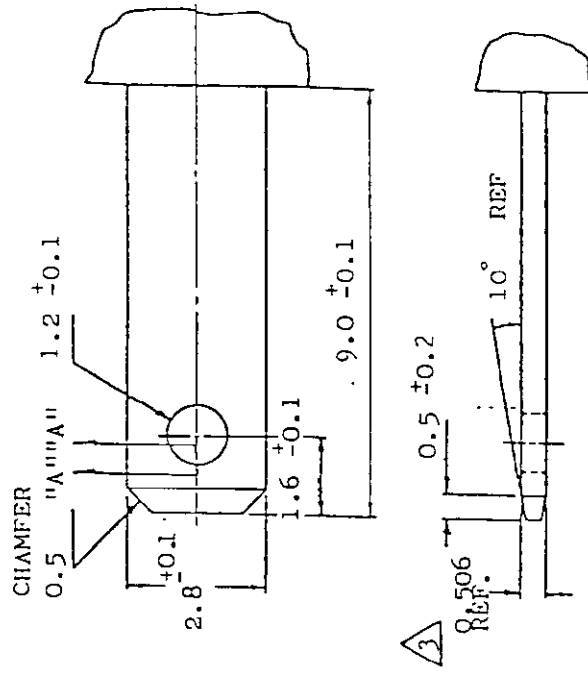
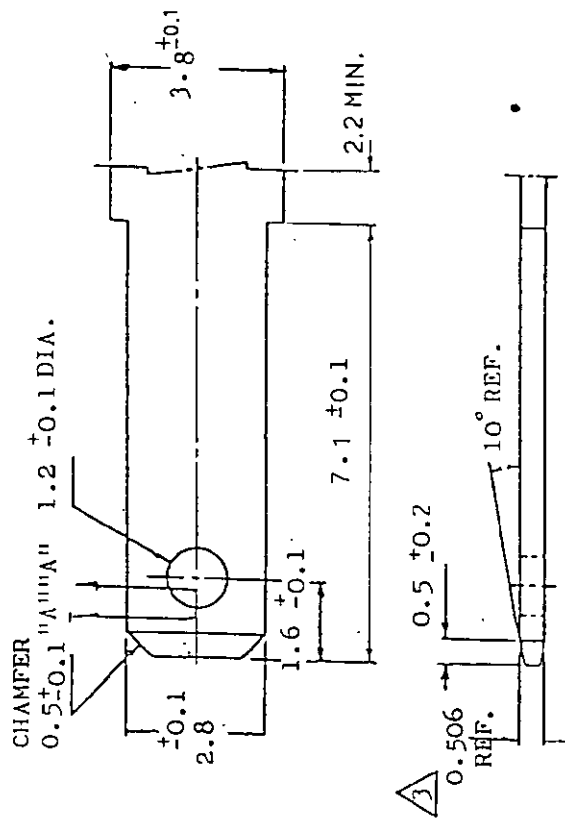

Fig. 2 Vibration, Low Frequency,
Test Method:

| | | | | |
|--|------------|---|-----------------------------------|-----------|
| SHEET | AMP | | AMP (Japan), Ltd. TOKYO, JAPAN | |
| 6 OF 7 | LOC J | A | NO 108-5252-1 | REV. 0 |
| NAME Product Specification 110 Series, Positive Lock Connector | | | | |



TAB DIMENSIONS WITH SHOULDER

TAB DIMENSIONS WITHOUT SHOULDER

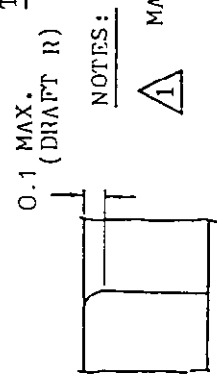

NOTES:

- 1 MATERIAL: BRASS (JIS H 3100, C-2600P-1/2H) OR EQUIVALENT
- 2 APPLICATION CLEARANCE SPACING IS AS SHOWN IN FIG. "A".
- 3 TAB STOCK THICKNESS TO BE 0.5 ± 0.025 TIN-PLATING THICKNESS TO BE 1 TO 3 MICRONMETER(S).

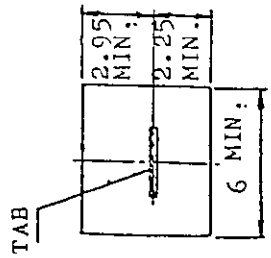

FIG. A

FIG. 3 RECOMMENDED TAB DIMENSIONS

UNIT: MM

| | | | | |
|-------------------------------------|------------|---|-----------------------------------|-----------|
| SHEET | AMP | | AMP (Japan), Ltd. TOKYO, JAPAN | |
| 7 OF 7 | LOC J | A | NO 108-5252 - 1 | REV. 0 |
| NAME Product Specification | | | | |
| 110 Series, Positive Lock Connector | | | | |

单击下面可查看定价，库存，交付和生命周期等信息

[>>TE Connectivity\(泰科\)](#)