

THIS DRAWING IS UNPUBLISHED. RELEASED FOR PUBLICATION 20
 © COPYRIGHT 20 BY - ALL RIGHTS RESERVED.

REVISIONS					
P	LTR	DESCRIPTION	DATE	DWN	APVD
	A	INITIAL RELEASE	29MAY2019	OL	SZ

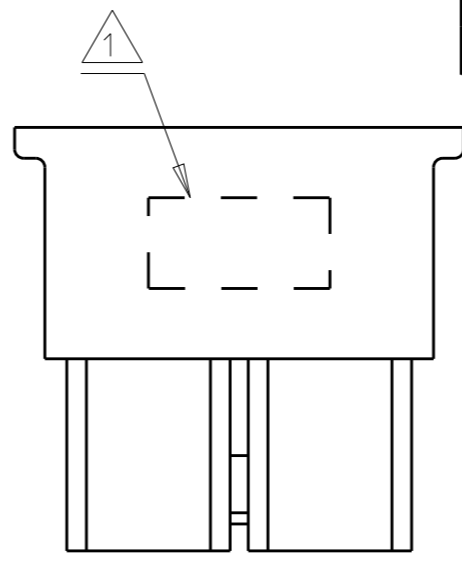

- NOTES:
1. PART NUMBER AND DATE CODE.
 2. MATERIAL: THERMO PLASTIC, UL94 V-0, COLOR: SEE PART NUMBER LIST.
 3. THIS RECEPTACLE HOUSING TO BE USED WITH RECEPTACLE TERMINAL 2204749.
 4. PACKAGED IN BULK BY BAG.

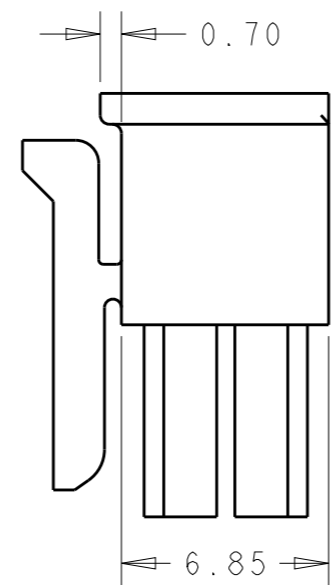
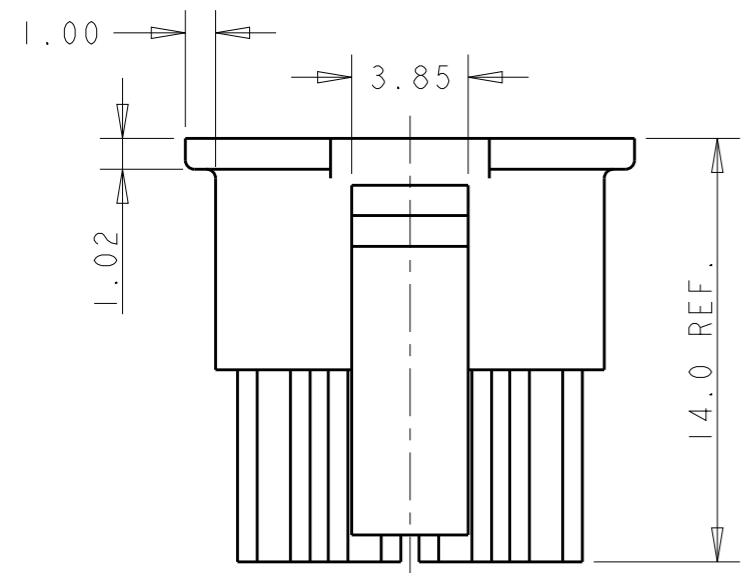
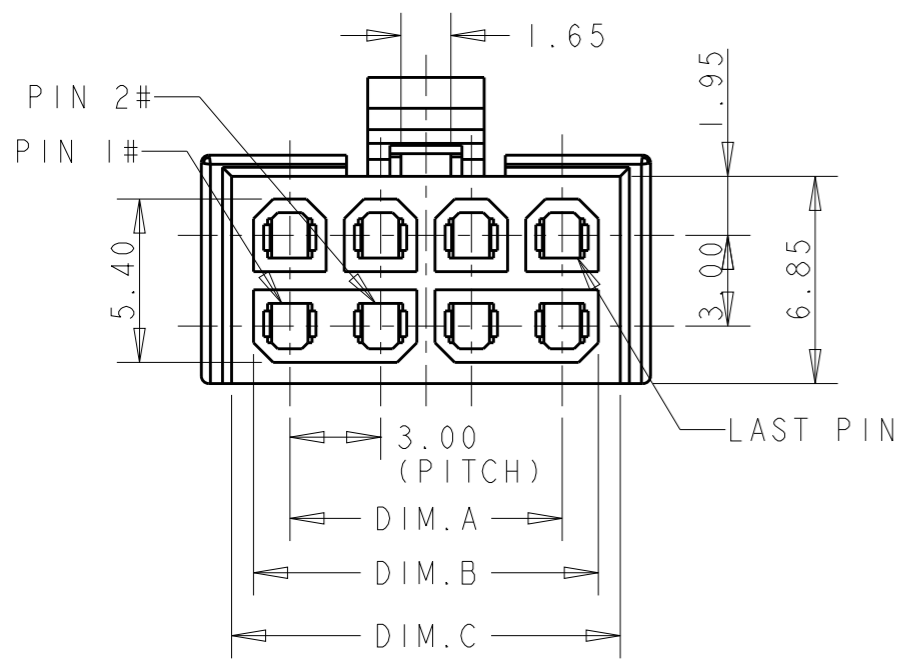

36.85	35.40	33.00	NATURE	24	2-2204748-4
33.85	32.40	30.00	NATURE	22	2-2204748-3
30.85	29.40	27.00	NATURE	20	2-2204748-2
27.85	26.40	24.00	NATURE	18	2-2204748-1
24.85	23.40	21.00	NATURE	16	2-2204748-0
21.85	20.40	18.00	NATURE	14	1-2204748-9
18.85	17.40	15.00	NATURE	12	1-2204748-8
15.85	14.40	12.00	NATURE	10	1-2204748-7
12.85	11.40	9.00	NATURE	8	1-2204748-6
9.85	8.40	6.00	NATURE	6	1-2204748-5
6.85	5.40	3.00	NATURE	4	1-2204748-4
3.85	2.40	N/A	NATURE	2	1-2204748-3
DIM.C	DIM.B	DIM.A	COLOR	CIRCUIT	PART NUMBER

36.85	35.40	33.00	BLACK	24	1-2204748-2
33.85	32.40	30.00	BLACK	22	1-2204748-1
30.85	29.40	27.00	BLACK	20	1-2204748-0
27.85	26.40	24.00	BLACK	18	2204748-9
24.85	23.40	21.00	BLACK	16	2204748-8
21.85	20.40	18.00	BLACK	14	2204748-7
18.85	17.40	15.00	BLACK	12	2204748-6
15.85	14.40	12.00	BLACK	10	2204748-5
12.85	11.40	9.00	BLACK	8	2204748-4
9.85	8.40	6.00	BLACK	6	2204748-3
6.85	5.40	3.00	BLACK	4	2204748-2
3.85	2.40	N/A	BLACK	2	2204748-1
DIM.C	DIM.B	DIM.A	COLOR	CIRCUIT	PART NUMBER

THIS DRAWING IS A CONTROLLED DOCUMENT.		DWN RADAR SUN 9-Aug-18	TE Connectivity	
DIMENSIONS: mm		CHK SUNY ZHAO 9-Aug-18		
TOLERANCES UNLESS OTHERWISE SPECIFIED:		APVD SUNY ZHAO 9-Aug-18	NAME ELCON MICRO POWER CONNECTOR, RECEPTACLE, HOUSING, 3.00MM PITCH, 2XN CIRCUITS	
0 PLC ±- 1 PLC ±±0.30 2 PLC ±±0.20 3 PLC ±- 4 PLC ±- ANGLES ±-		PRODUCT SPEC 108-128068	RESTRICTED TO	
MATERIAL		APPLICATION SPEC	SIZE A300779	DRAWING NO C-2204748
FINISH		WEIGHT	SCALE 4:1	SHEET 1 OF 2
		CUSTOMER DRAWING	REV A	

REVISIONS

P	LTR	DESCRIPTION	DATE	DWN	APVD
-	-	SEE SHEET 1	-	-	-

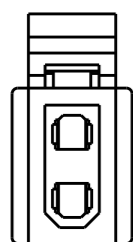

CIRCUIT SIZE:2

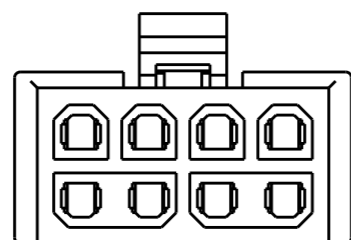

CIRCUIT SIZE:8

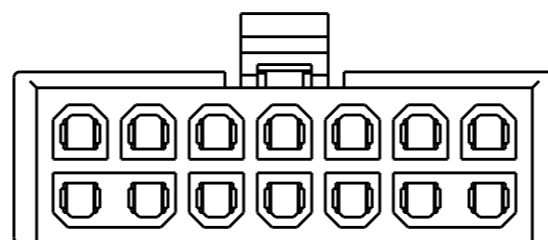

CIRCUIT SIZE:14

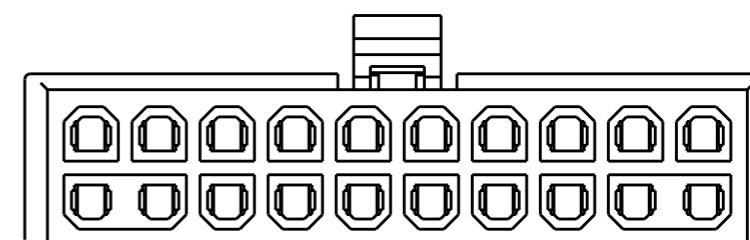

CIRCUIT SIZE:20

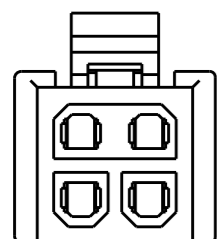

CIRCUIT SIZE:4

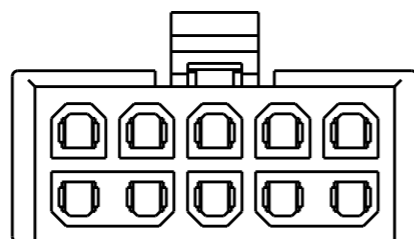

CIRCUIT SIZE:10

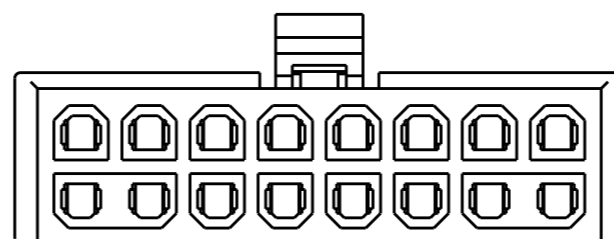

CIRCUIT SIZE:16

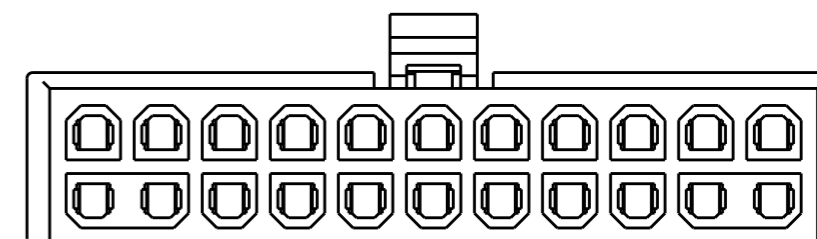

CIRCUIT SIZE:22

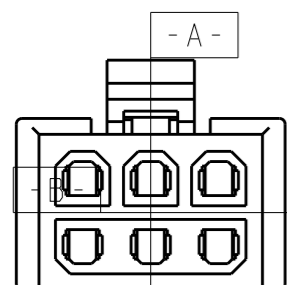

CIRCUIT SIZE:6

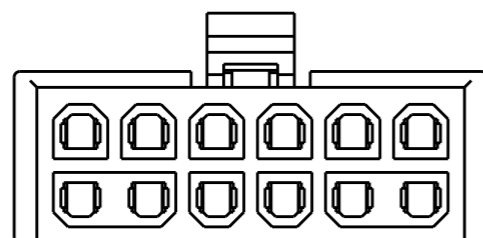

CIRCUIT SIZE:12

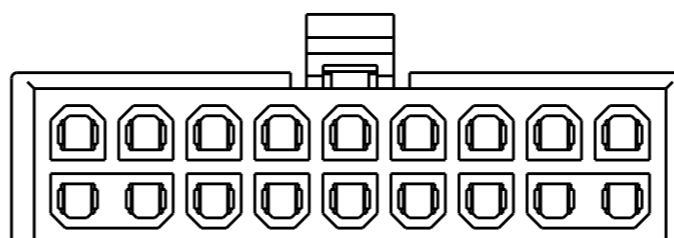

CIRCUIT SIZE:18

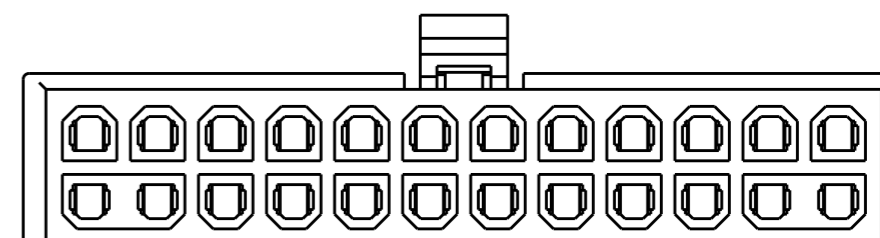

CIRCUIT SIZE:24

THIS DRAWING IS A CONTROLLED DOCUMENT.

DIMENSIONS:	
mm	
MATERIAL	
-	

TOLERANCES UNLESS OTHERWISE SPECIFIED:	
0 PLC	±-
1 PLC	±±0.30
2 PLC	±±0.20
3 PLC	±-
4 PLC	±-
ANGLES	±-
FINISH	
-	

DWN	RADAR SUN	9-Aug-18
CHK	SUNY ZHAO	9-Aug-18
APVD	SUNY ZHAO	9-Aug-18
PRODUCT SPEC	108-128068	
APPLICATION SPEC	-	
WEIGHT	-	
CUSTOMER DRAWING		

TE Connectivity		NAME	
		ELCON MICRO POWER CONNECTOR, RECEPTACLE, HOUSING, 3.00MM PITCH, 2XN CIRCUITS	
SIZE	CAGE CODE	DRAWING NO	RESTRICTED TO
A3	00779	C-2204748	-
SCALE		SHEET	REV
3:1		2 OF 2	A

单击下面可查看定价，库存，交付和生命周期等信息

[>>TE Connectivity\(泰科\)](#)