

4

3

2

1

THIS DRAWING IS UNPUBLISHED. RELEASED FOR PUBLICATION 20
© COPYRIGHT 20 BY - ALL RIGHTS RESERVED.

REVISIONS

P	LTR	DESCRIPTION	DATE	DWN	APVD
A2		ECR-16-007959	13JUN2016	RL	CW
A3		ECR-16-017508	13DEC2016	RL	CW
B		ECR-18-005861	03AUG2018	YC	CW
C		ECR-21-122216	09DEC2021	WQR	CW

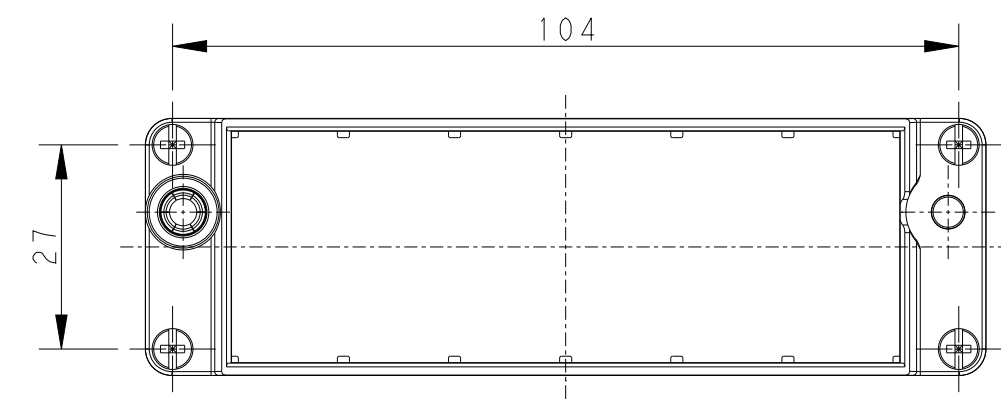
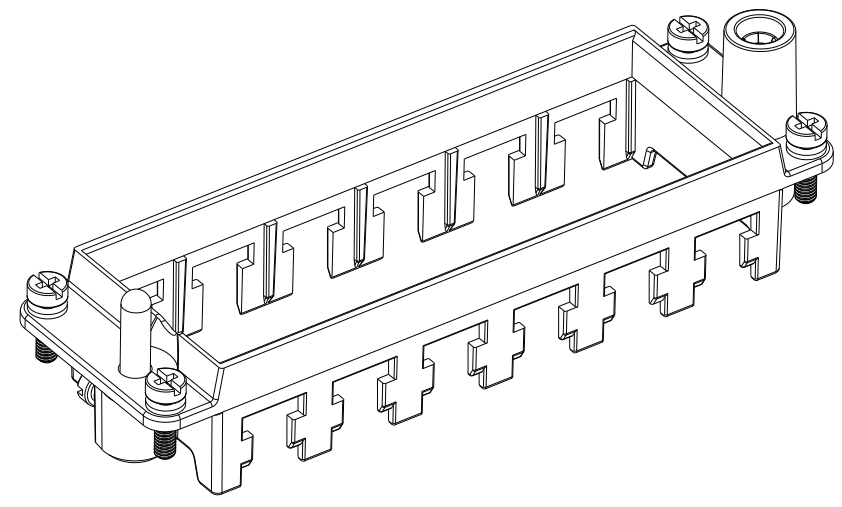

NOTES:
 1. TECHNICAL CHARACTERISTICS:
 FRAME MATERIAL: DIE CAST ZINC ALLOY
 NUMBER OF MODULES: 6
 SURFACE: ZINC PLATED
 MATING CYCLES: 500 CYCLES

注释:
 1. 技术参数:
 框架材料: 锌合金
 模块数量: 6
 表面处理: 镀锌
 插拔次数: 500次

4X M3 SCREW
 RECOMMENDED TIGHTENING TORQUE 0.5Nm
 4X M3 螺丝推荐锁紧力矩为0.5Nm

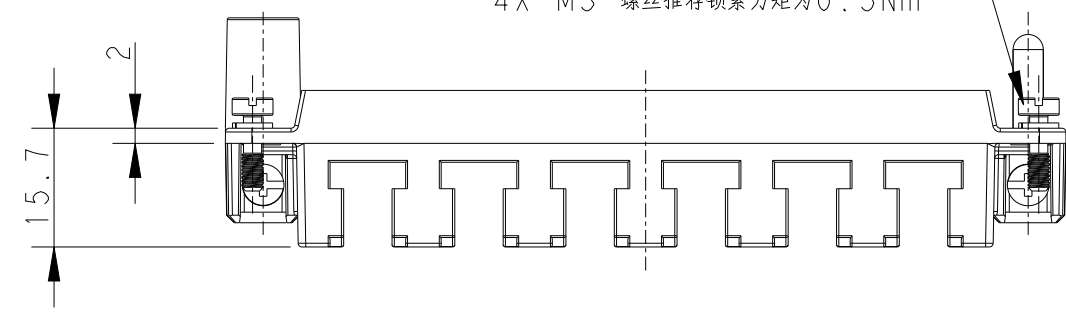
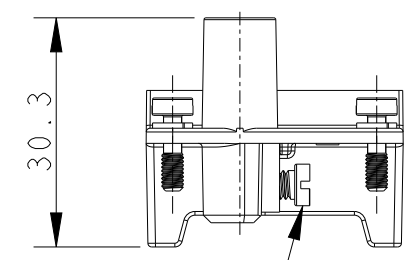

2X M4 SCREW, RECOMMENDED TIGHTENING TORQUE 1.2Nm
 2X M4 螺丝, 推荐锁紧力矩为1.2Nm

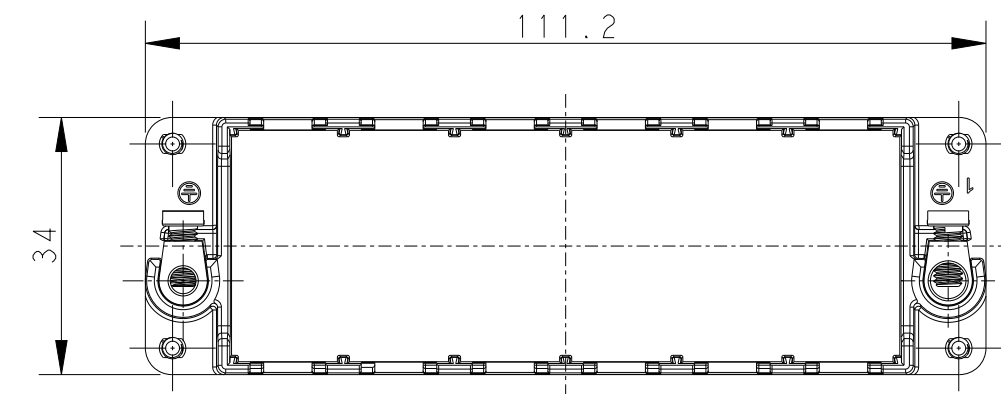

PANEL CUT FOR FRAME USE WITHOUT HOODS/ HOUSINGS

T2070244001-000 SHOWN ABOVE WITHOUT MARK
 T2070244001-000, 不带标记

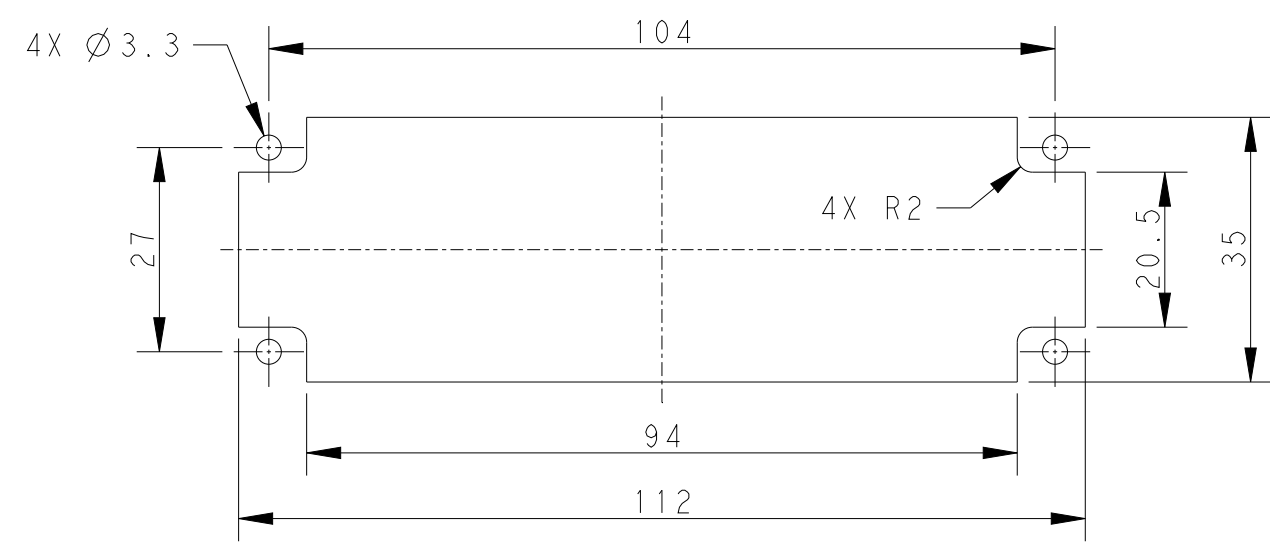

T2070244001-000	H24BN-T6	H24BN MODULE FRAME H24BN模块框架
T2070244101-000	H24BN-T6-M	H24BN MALE MODULE FRAME H24BN模块公框架
T2070244201-000	H24BN-T6-F	H24BN FEMALE MODULE FRAME H24BN模块母框架
T2070244101-001	H24BN-T6-M	H24BN MALE MODULE FRAME, MARK, NO LOGO H24BN模块公框架带标记, 不带LOGO
T2070244201-001	H24BN-T6-F	H24BN FEMALE MODULE FRAME, MARK, NO LOGO H24BN模块母框架带标记, 不带LOGO
PART NUMBER 料号		PART DESCRIPTION 描述

DIMENSIONS:		TOLERANCES UNLESS OTHERWISE SPECIFIED:	
mm			
	0 PLC	±	-
	1 PLC	±	-
	2 PLC	±	-
	3 PLC	±	-
	4 PLC	±	-
	ANGLES	±	-
	FINISH		
MATERIAL			

THIS DRAWING IS A CONTROLLED DOCUMENT.

DWN 28FEB2015 DAVID WANG
 CHK 28FEB2015 CHRIS WANG
 APVD 28FEB2015 XIANG XU

NAME H24BN-T6

PRODUCT SPEC 108-137057
 APPLICATION SPEC 114-137057

WEIGHT -

Customer Drawing

SCALE 1:1 SHEET 1 OF 3 REV C

RESTRICTED TO -

REVISIONS

P	LTR	DESCRIPTION	DATE	DWN	APVD
-	-	SEE SHEET 1	-	-	-

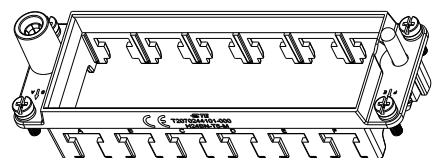

SCALE 1:2

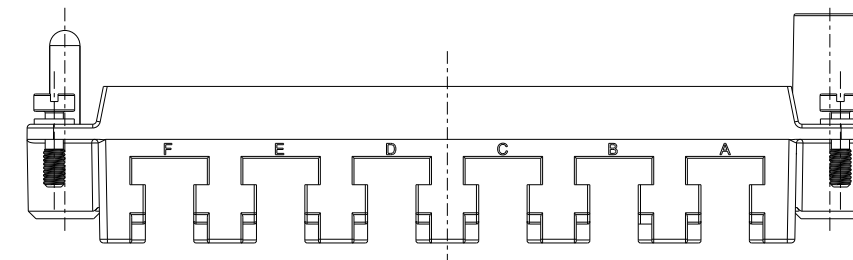
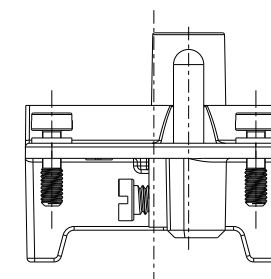
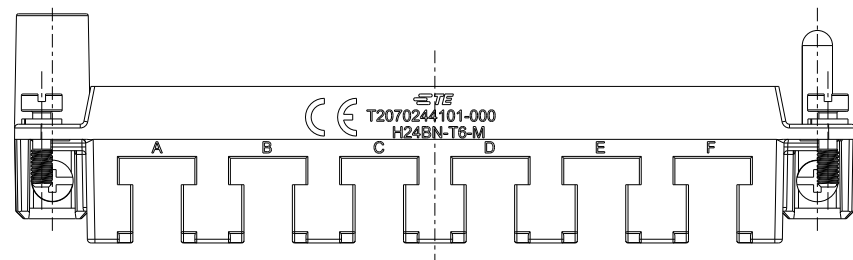
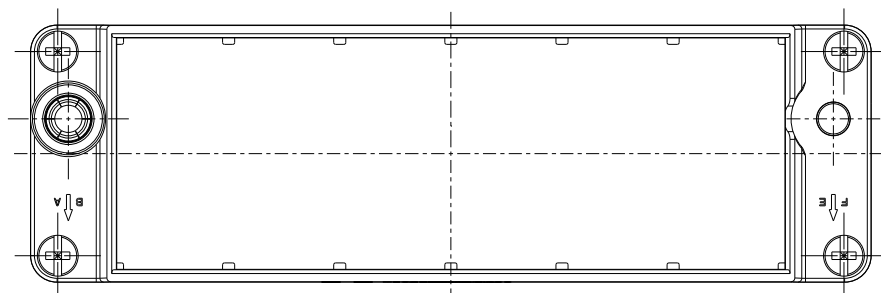

T2070244101-000, H24BN-T6-M SHOWN
 WITH MARK, ALL DIMENSIONS THE SAME TO T2070244001-000
 T2070244101-000, H24BN-T6-M, 带标记, 所有尺寸同T2070244001-000一样

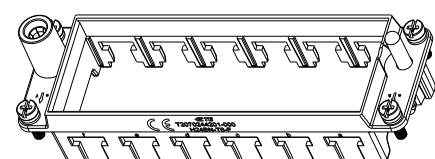

SCALE 1:2

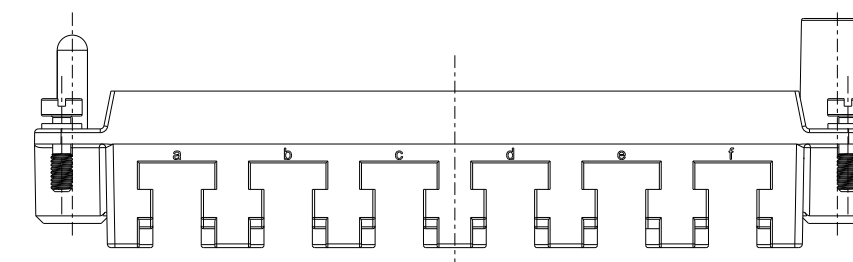
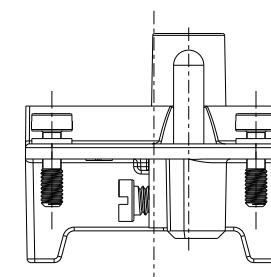
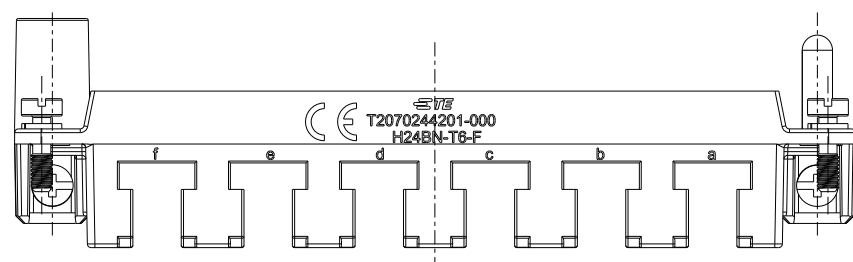
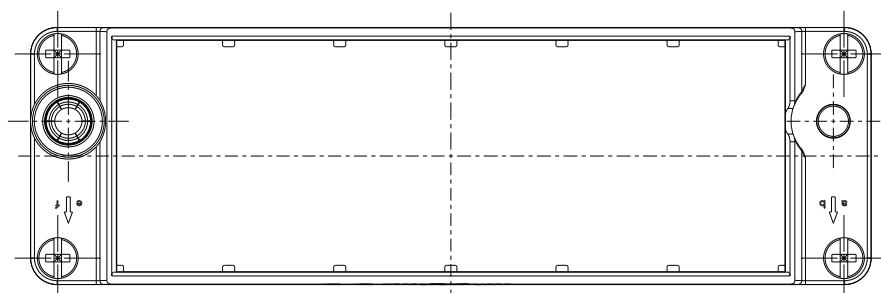

T2070244201-000, H24BN-T6-F SHOWN
 WITH MARK, ALL DIMENSIONS THE SAME TO T2070244001-000
 T2070244201-000, H24BN-T6-F, 带标记, 所有尺寸同T2070244001-000一样

THIS DRAWING IS A CONTROLLED DOCUMENT.

DIMENSIONS:	TOLERANCES UNLESS OTHERWISE SPECIFIED:
mm	0 PLC ±-
	1 PLC ±-
	2 PLC ±-
	3 PLC ±-
	4 PLC ±-
	ANGLES ±-
MATERIAL	FINISH
-	-
-	-

DWN	28FEB2015
DAVID WANG	
CHK	28FEB2015
CHRIS WANG	
APVD	28FEB2015
XIANG XU	
PRODUCT SPEC	108-137057
APPLICATION SPEC	114-137057
WEIGHT	-
Customer Drawing	

TE Connectivity		NAME		RESTRICTED TO
		H24BN-T6		
SIZE	CAGE CODE	DRAWING NO	RESTRICTED TO	
A3	-	©-T2070244001000	-	
SCALE		SHEET	OF	REV
1:1		2	3	C

4

3

2

1

THIS DRAWING IS UNPUBLISHED.

RELEASED FOR PUBLICATION

20

© COPYRIGHT 20 BY -

ALL RIGHTS RESERVED.

REVISIONS

P	LTR	DESCRIPTION	DATE	DWN	APVD
-		SEE SHEET 1	-	-	-

SCALE 1:2

T2070244101-001, H24BN-T6-M SHOWN WITH MARK,
WITHOUT LOGO, ALL DIMENSIONS THE SAME TO T2070244001-000
T2070244101-001, H24BN-T6-M, 带标记, 不带LOGO, 所有尺寸同T2070244001-000一样

SCALE 1:2

T2070244201-001, H24BN-T6-F SHOWN WITH MARK,
WITHOUT LOGO, ALL DIMENSIONS THE SAME TO T2070244001-000
T2070244201-001, H24BN-T6-F, 带标记, 不带LOGO, 所有尺寸同T2070244001-000一样

THIS DRAWING IS A CONTROLLED DOCUMENT.

DWN 28FEB2015

DAVID WANG

CHK 28FEB2015

CHRIS WANG

APVD 28FEB2015

XIANG XU

PRODUCT SPEC

108-137057

APPLICATION SPEC

114-137057

WEIGHT

-

CUSTOMER DRAWING

TE Connectivity

NAME

H24BN-T6

SIZE

A3

CAGE CODE

-

DRAWING NO

C-T2070244001000

RESTRICTED TO

-

SCALE 1:1

SHEET 3 OF 3

REV C

DIMENSIONS:

mm

TOLERANCES UNLESS OTHERWISE SPECIFIED:

0 PLC	±-
1 PLC	±-
2 PLC	±-
3 PLC	±-
4 PLC	±-
ANGLES	±-
FINISH	-

MATERIAL

-

1470-19 (3/13)

Downloaded From Onevac.com

单击下面可查看定价，库存，交付和生命周期等信息

[>>TE Connectivity\(泰科\)](#)