

LOC		DIST		REVISIONS			
P	LTR	DESCRIPTION	DATE	DMN	APVD		
0		RELEASED PER EC 0512-0317-04	15DEC04	BM	RW		
01		REVISED PER ECO-09-024606	31OCT09	KK	AEG		

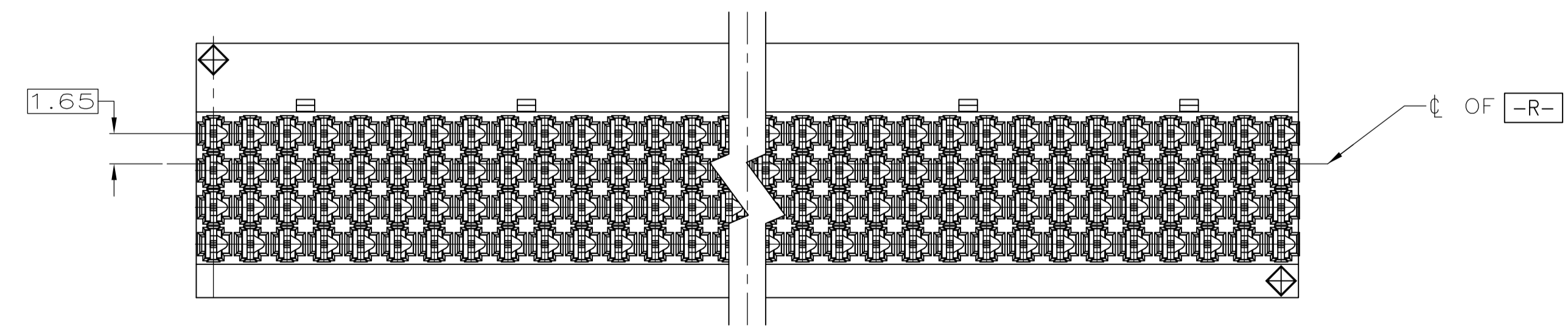

- △ HOUSING MATERIAL: LIQUID CRYSTAL POLYMER. COLOR: NATURAL
- △ CONTACT MATERIAL: PHOSPHOR-BRONZE
- △ CONTACT FINISH:(A)
 UNDERPLATE (ENTIRE CONTACT):
 0.00127 MIN NICKEL PER SAE-AMS-QQ-N-290
 ON MATING SURFACES:
 CONFORMS TO ALL TESTING SPECIFIED FOR TELCORDIA
 UNCONTROLLED ENVIRONMENT.
 ON LEADS:
 0.00381 MIN MATTE TIN PER ASTM B 545 OVER UNDERPLATE.
 LUBRICATION (MIN MATING SURFACES):
 SURFACE CONDITIONER AFTER PLATING.
- △ PART MARKING, LOCATED APPROXIMATELY AS SHOWN.
- △ OBSOLETE PARTS: OBSOLETE CIS STREAMLINING PER D.RENAUD/D.SINISI

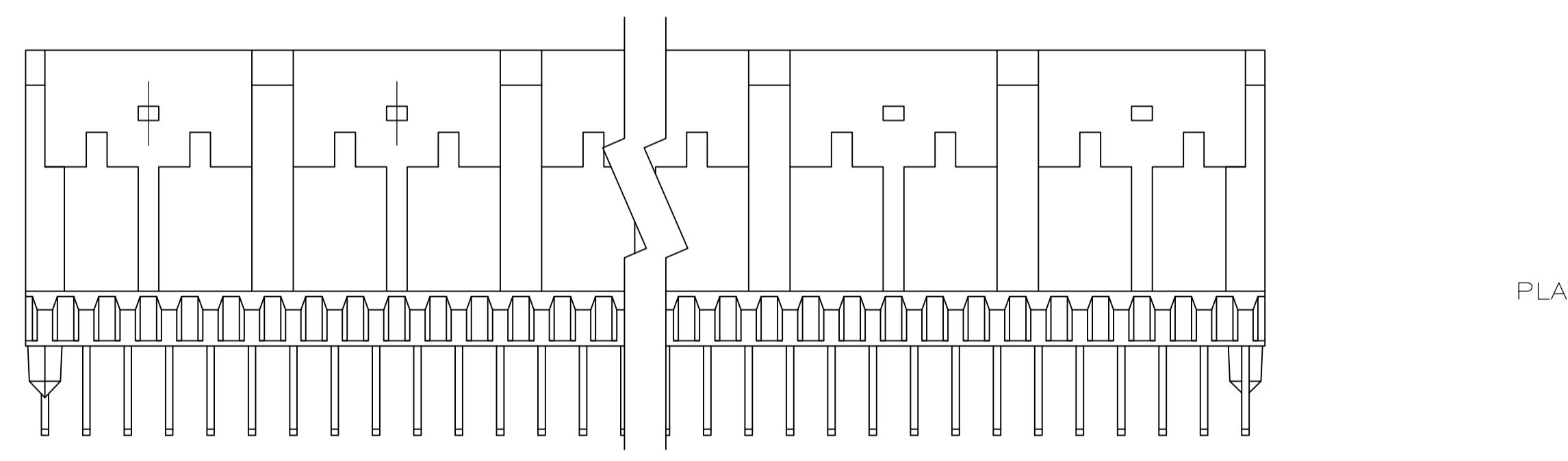
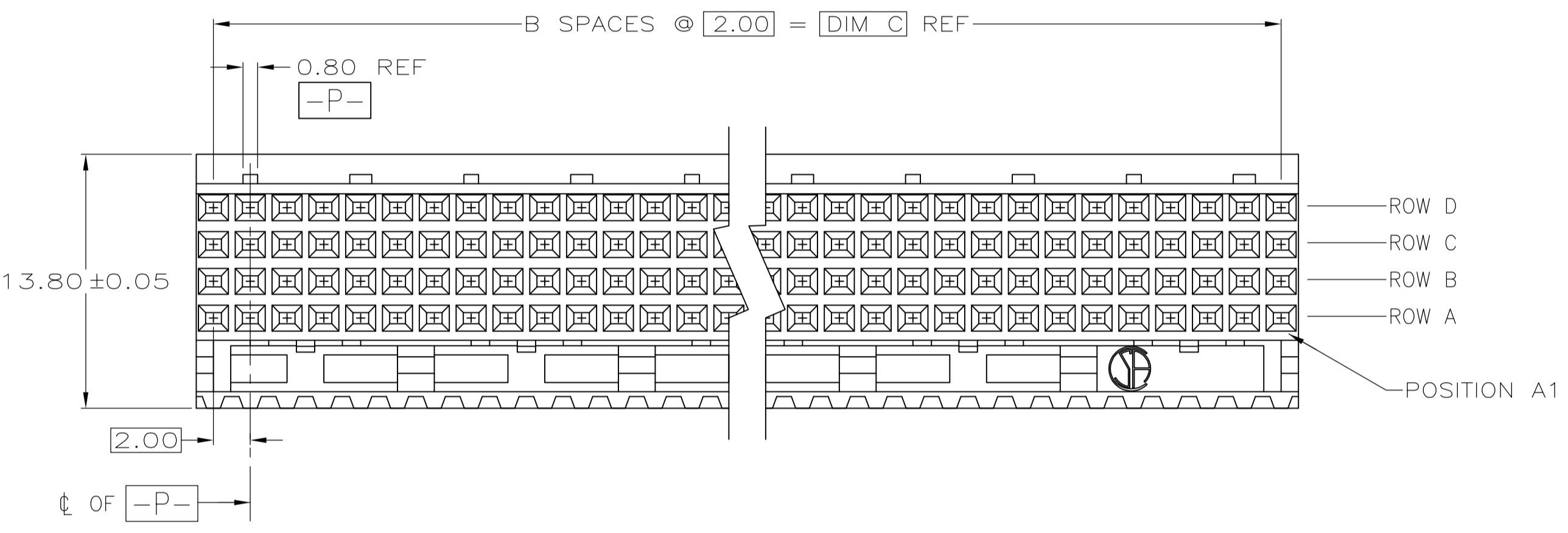
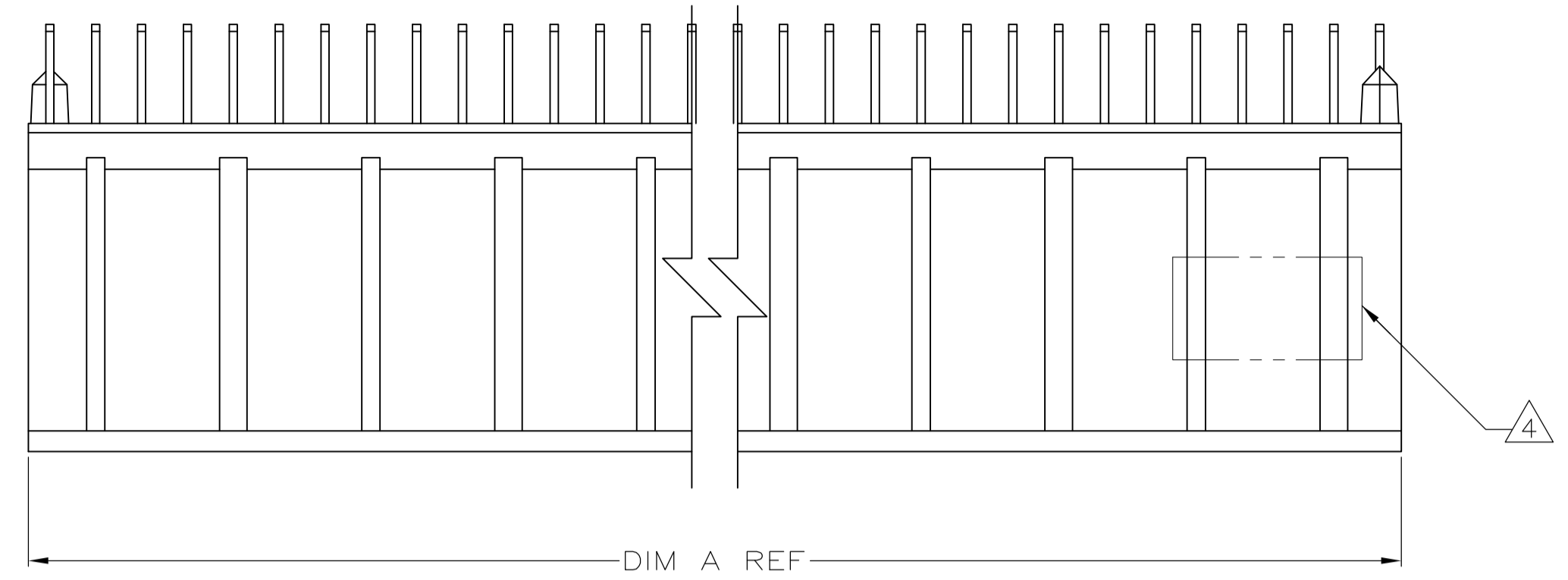
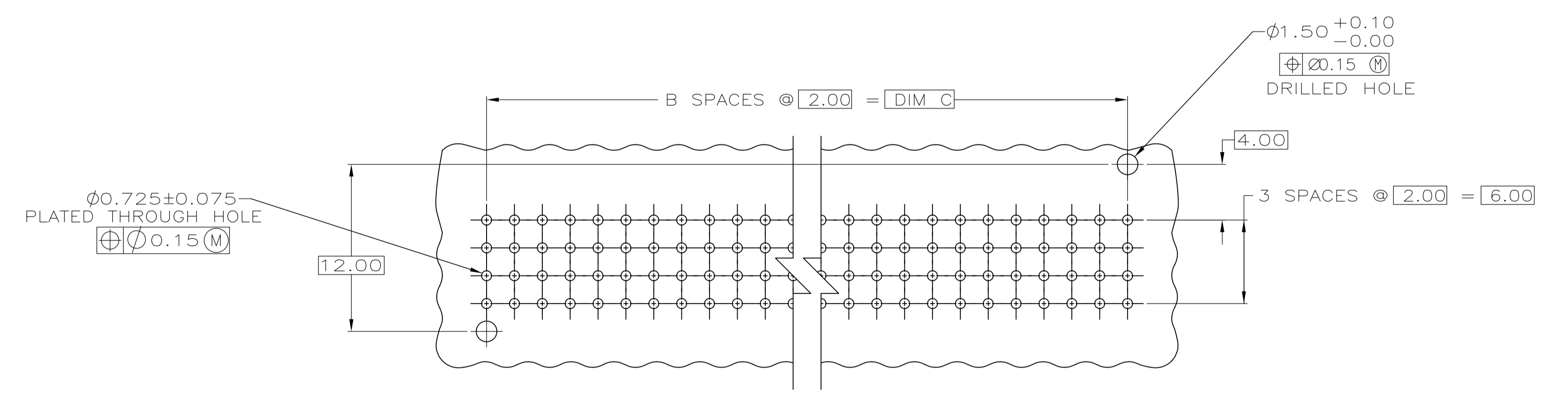
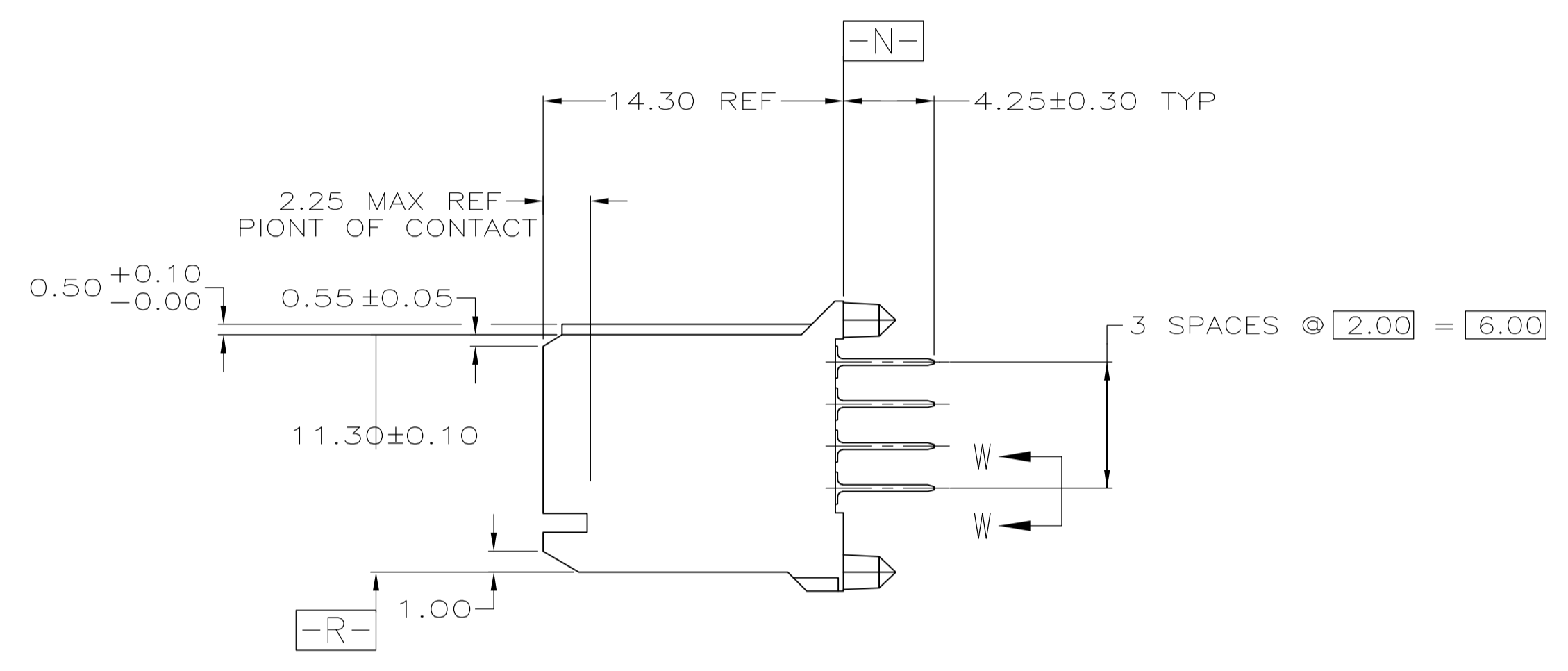

RECOMMENDED CIRCUIT PATTERN
(COMPONENT SIDE)

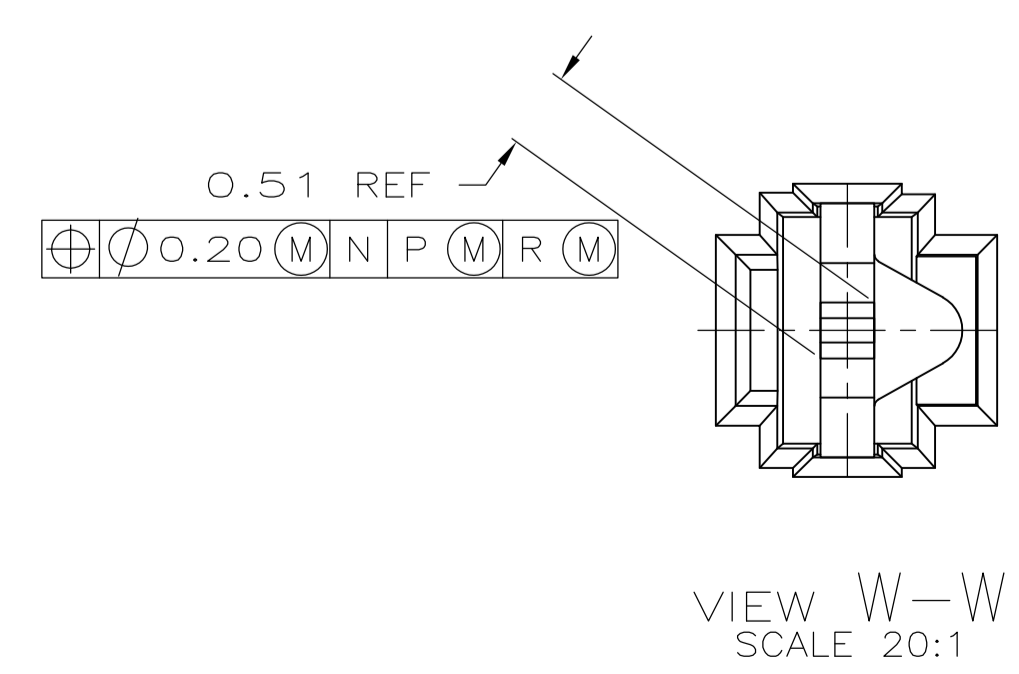

VIEW W-W
SCALE 20:1

	DIM C	B	DIM A	NUMBER OF SIGNAL POSITIONS	PART NUMBER
△ OBSOLETE	94.00	47	95.88	192	5223655-8
	82.00	41	83.88	168	5223655-7
	70.00	35	71.88	144	5223655-6
	58.00	29	59.88	120	5223655-5
	46.00	23	47.88	96	5223655-4
△ OBSOLETE	34.00	17	35.88	72	5223655-3
	22.00	11	23.88	48	5223655-2
	10.00	5	11.88	24	5223655-1

THIS DRAWING IS A CONTROLLED DOCUMENT.

DIMENSIONS: mm	TOLERANCES UNLESS OTHERWISE SPECIFIED:	DIN B MCMMASTER 150EC04	Tyco Electronics Corporation
0 PLC ± -	1 PLC ± -	DR R WERTZ 150EC04	Harrisburg, Pa 17105-3608
2 PLC ± 0.13	3 PLC ± -	NAME R WERTZ 150EC04	ASSEMBLY, RECEPTACLE, SIGNAL, VERTICAL, 4 ROW, Z-PACK 2mm FB, WITH SOLDER LEADS
4 PLC ± -	ANGLES ± -	PRODUCT SPEC	SIZE A1
MATERIAL	FINISH	APPLICATION SPEC	WEIGHT
1	2	3	CUSTOMER DRAWING

SCALE 4:1 SHEET 1 OF 1 REV 01

单击下面可查看定价，库存，交付和生命周期等信息

[>>TE Connectivity\(泰科\)](#)