

REVISIONS					
P	LTR	DESCRIPTION	DATE	DWN	APVD
D		DESIGN IMPROVEMENT IN NEW MOLD	13AUG2020	DV	PS
E		REVISED AS PER PCN: E-20-012263	12OCT2021	SCB	SS

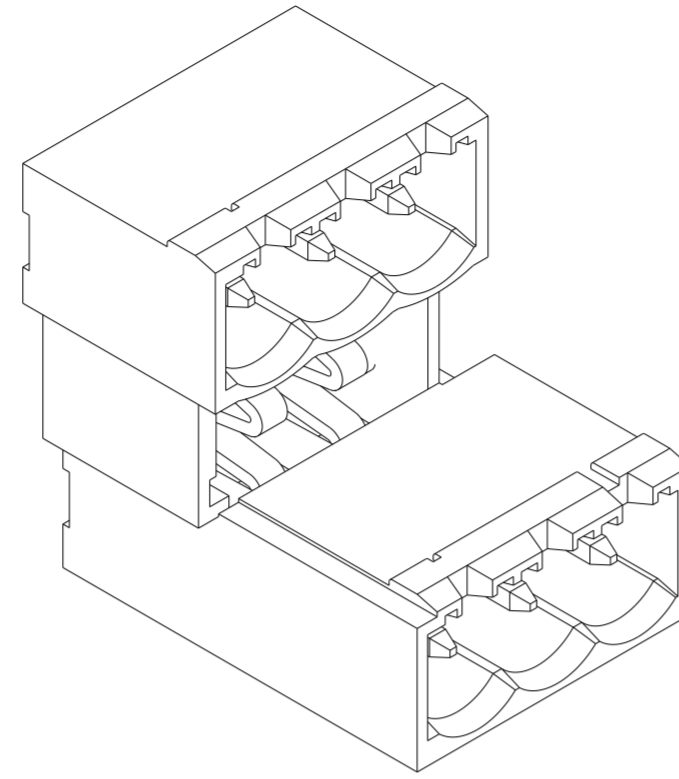
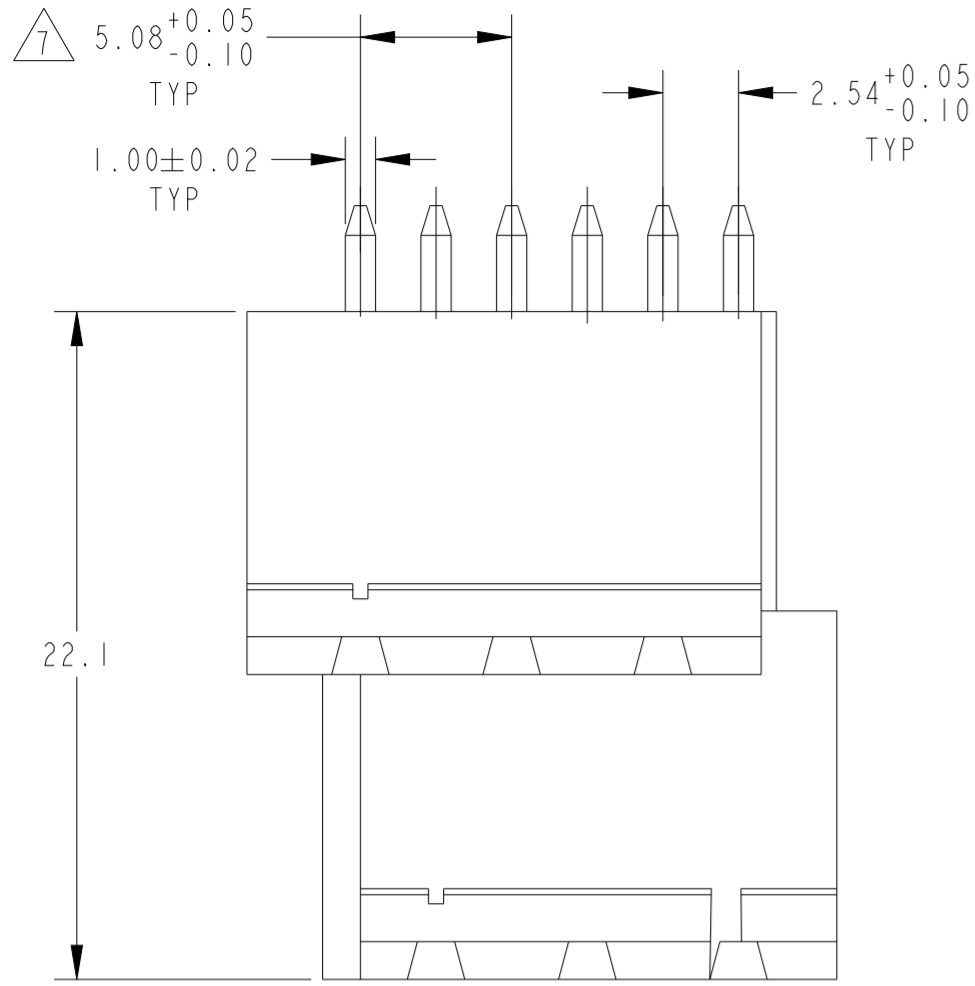

264065-3 AS SHOWN

- 1. MATERIALS AND FINISH:  
HOUSING: HIGH TEMPERATURE POLYAMIDE, UL 94-V0, COLOR GREEN.  
TERMINAL: COPPER ALLOY, TIN PLATED.
- 2. SUITABLE FOR 1.6-2.4mm PC BOARD THK.
- 3. ELECTRICAL  
RATED VOLTAGE : 300 V  
RATED CURRENT : 12 A  
CONTACT RESISTANCE : < 15 mΩ  
INSULATION RESISTANCE : > 1000 MΩ (500V DC)
- 4. OPERATING TEMPERATURE RANGE: -40°C TO +110°C
- 5. P/N FROM 284065-4 TO 2-284065-5 ARE OBTAINED BY ASSEMBLING DIFFERENT MONOLITHIC MODULES CHOSEN AMONG: 284065-2 AND 284065-3, IN ORDER TO REALIZE THE DESIRED NO. OF WAYS.

- 6. MODULES AND KEYS TO BE GLUED IN PLACE.
- 7. NON CUMULATIVE TOLERANCE

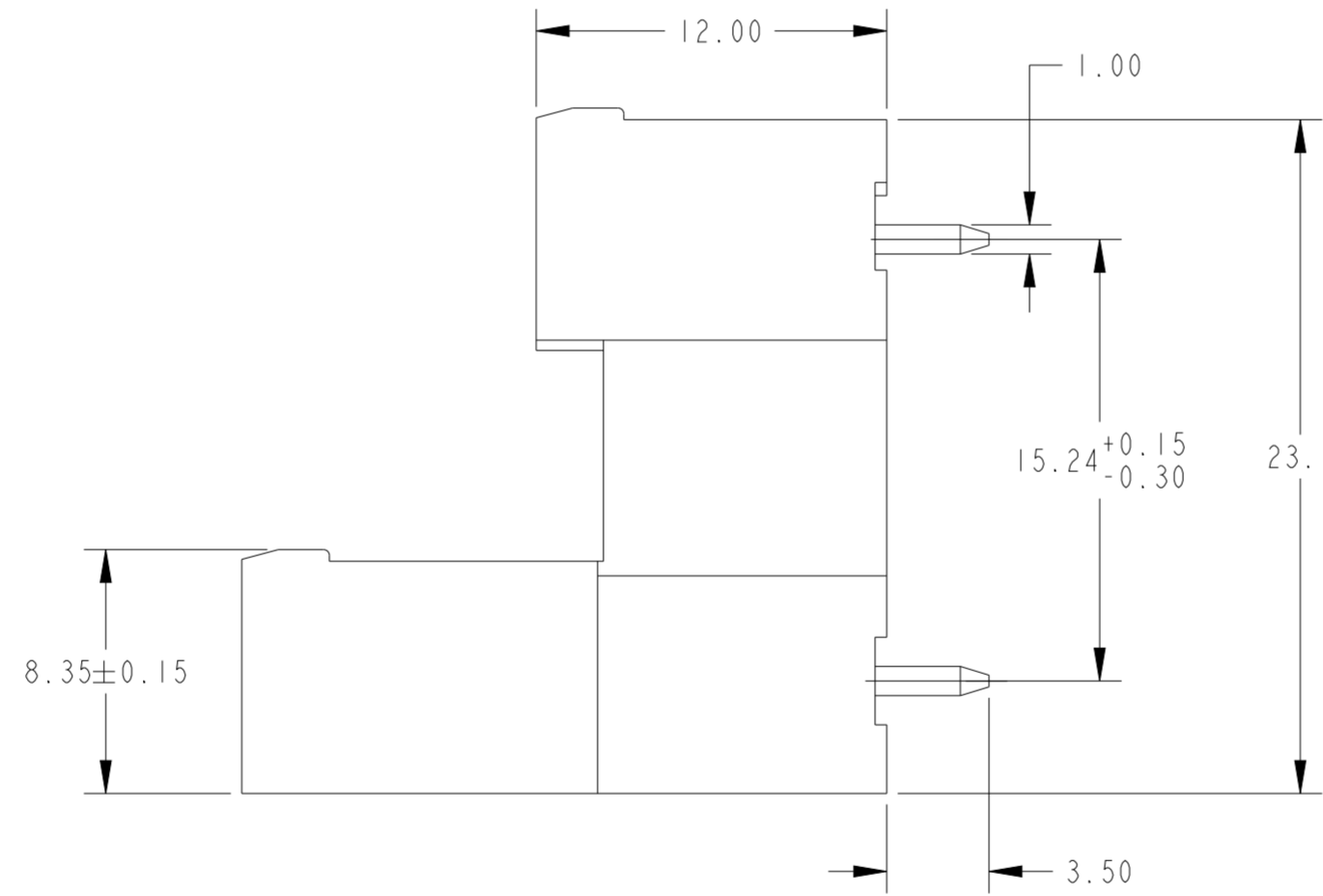
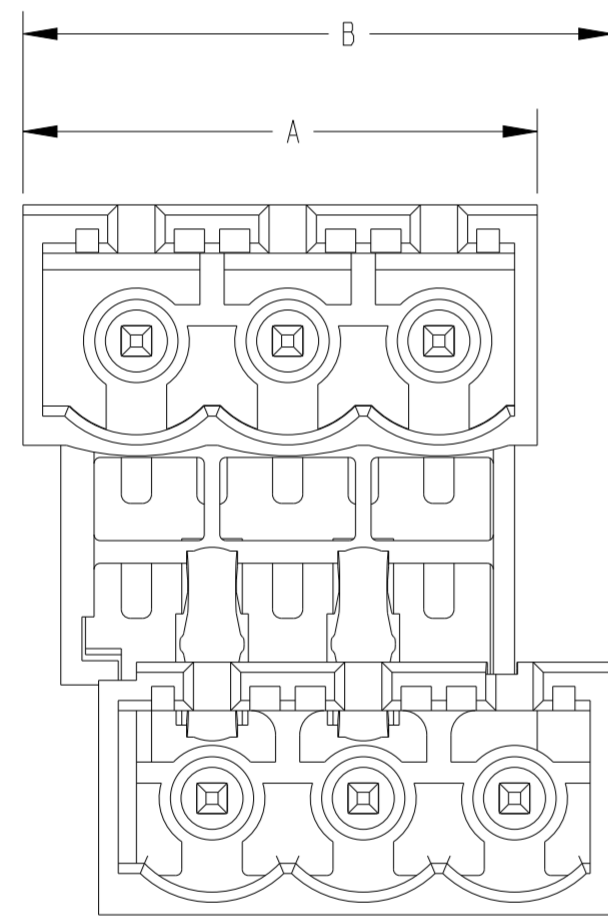

RECOMMENDED PC BOARD LAYOUT

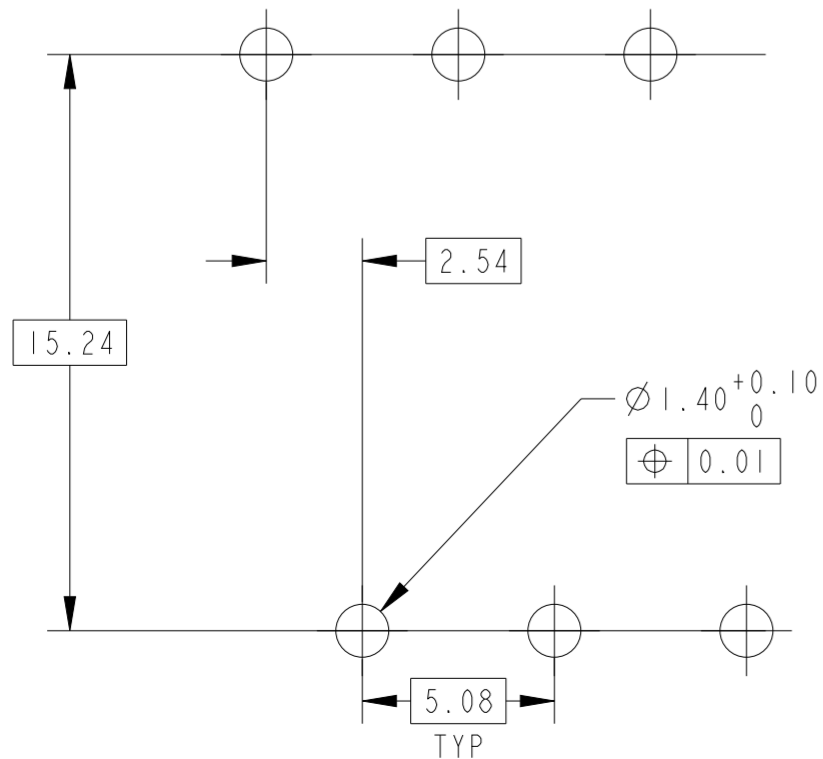

6	108.44	110.94	21	3-284065-3
6	77.96	80.46	15	3-284065-2
6	83.08	85.58	16	3-284065-1
6	123.68	126.18	24	3-284065-0
6	123.68	126.18	24	2-284065-9
6	93.2	95.7	18	2-284065-8
6	83.08	85.58	16	2-284065-7
6	62.72	65.22	12	2-284065-6
	128.8	131.3	25	2-284065-5
	123.68	126.18	24	2-284065-4
	118.64	121.14	23	2-284065-3
	113.56	116.06	22	2-284065-2
	108.44	110.94	21	2-284065-1
	103.4	105.9	20	2-284065-0
	98.32	100.82	19	1-284065-9
	93.2	95.7	18	1-284065-8
	88.16	90.66	17	1-284065-7
	83.08	85.58	16	1-284065-6
	77.96	80.46	15	1-284065-5
	72.92	75.42	14	1-284065-4
	67.84	70.34	13	1-284065-3
	62.72	65.22	12	1-284065-2
	57.68	60.18	11	1-284065-1
	52.6	55.1	10	1-284065-0
	47.48	49.98	9	284065-9
	42.44	44.94	8	284065-8
	37.36	39.86	7	284065-7
	32.24	34.74	6	284065-6
	27.2	29.7	5	284065-5
	22.16	24.66	4	284065-4
	17	19.5	3	284065-3
	12	14.5	2	284065-2
	DIM "A"	DIM "B"	NO. OF POSITION	PART NUMBER

THIS DRAWING IS A CONTROLLED DOCUMENT.

DWN: S SCHLEGEL 07MAR2008  
CHK: C RICHARD 03JUL2008  
APVD: C RICHARD 03JUL2008

**STE** TE Connectivity

NAME: TERMINAL BLOCK, MULTIPLE HEADER. 180 DEGREE, CLOSED ENDS, 5.08mm PITCH

APPLICATION SPEC: 114-20079

SIZE: A2 CAGE CODE: 00779 DRAWING NO: C-284065

MATERIAL: FINISH: CUSTOMER DRAWING

WEIGHT: -

SCALE: 5:1 SHEET: 1 OF 4 REV: E

REVISIONS					
P	LTR	DESCRIPTION	DATE	DWN	APVD
-		SEE SHEET 1	-	-	-

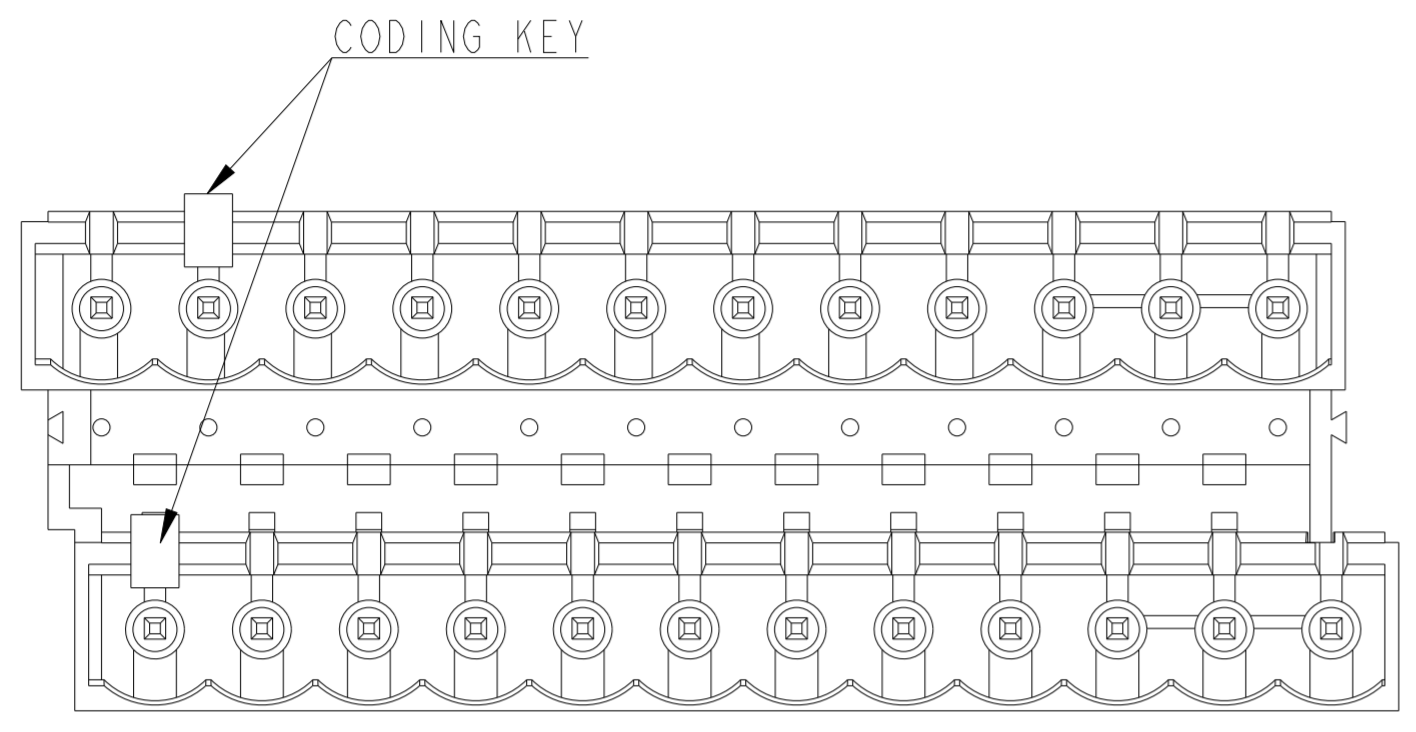

2-284065-6

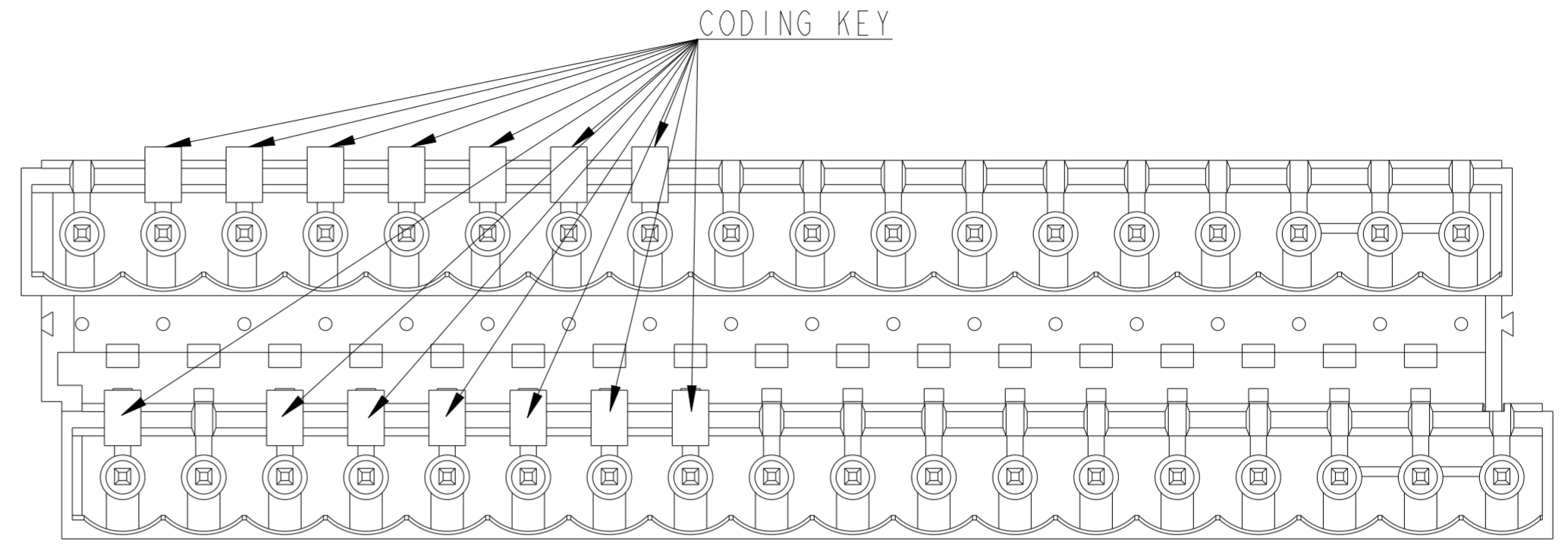

2-284065-9

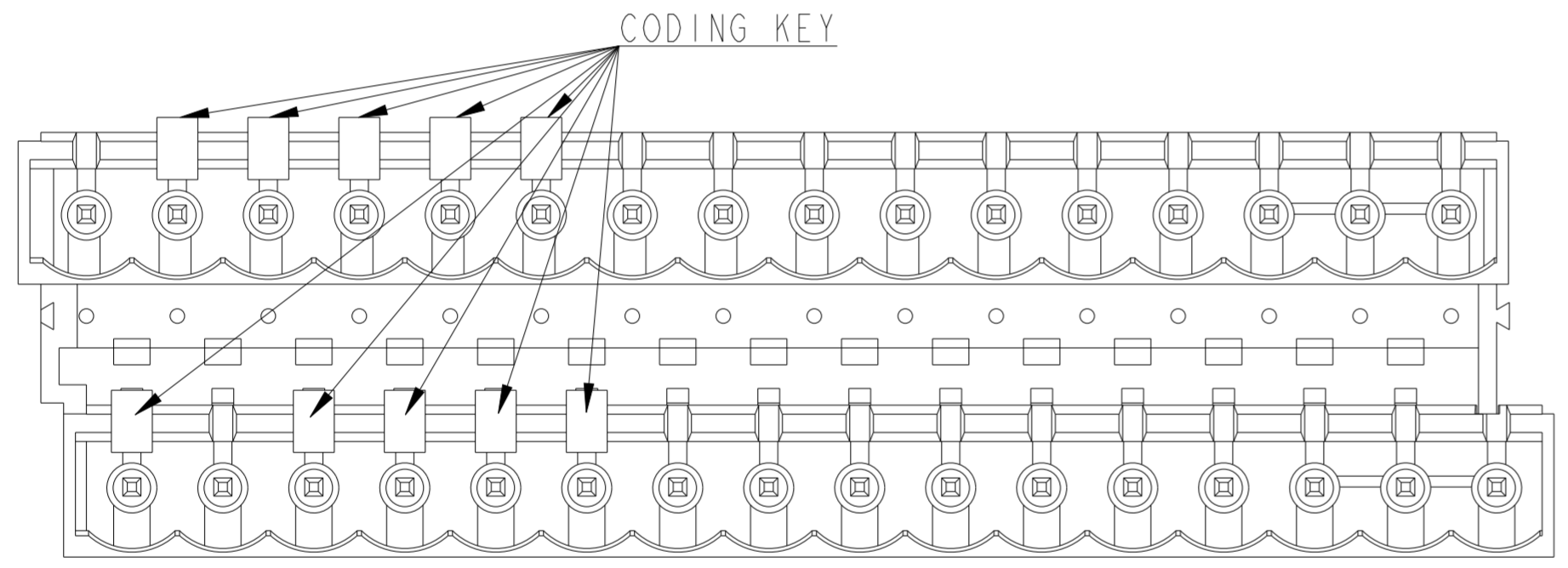

2-284065-7

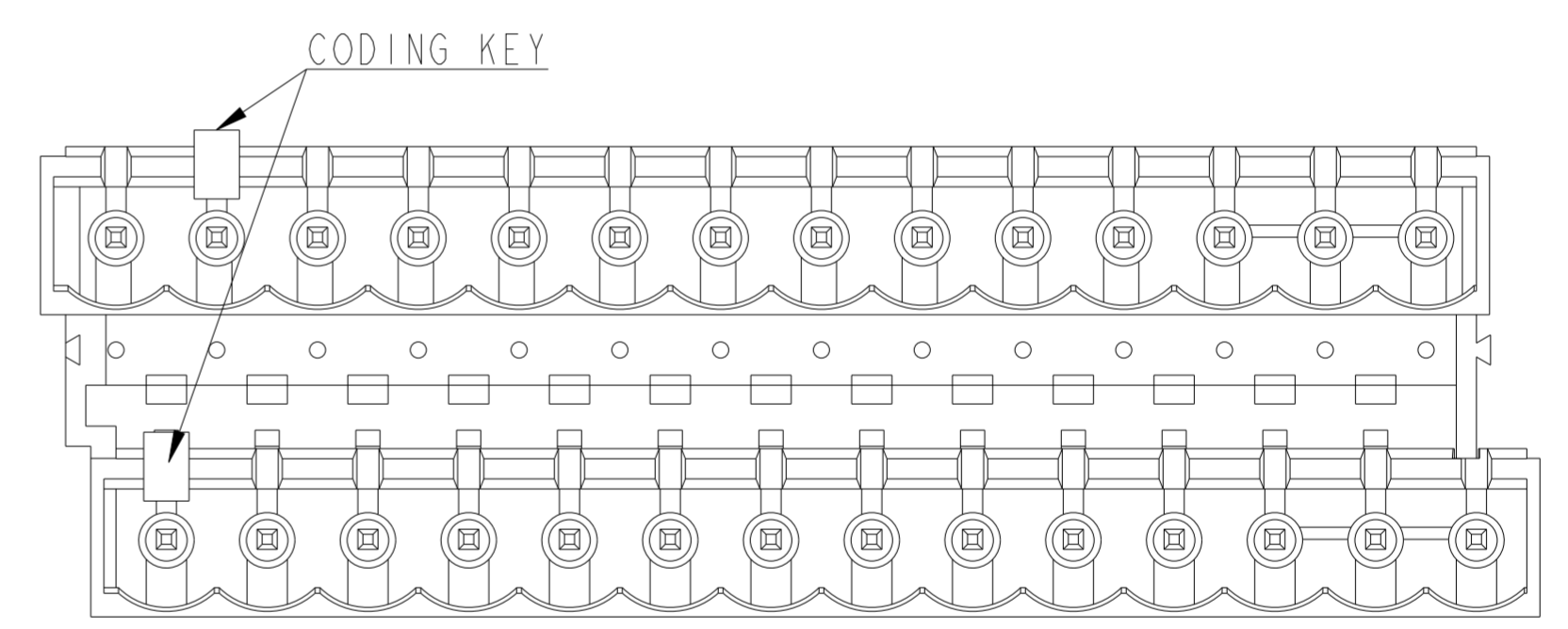



2-284065-8

THIS DRAWING IS A CONTROLLED DOCUMENT.		DWN S SCHLEGEL 07MAR2008	 TE Connectivity		
DIMENSIONS: mm		CHK C RICHARD 03JUL2008			
TOLERANCES UNLESS OTHERWISE SPECIFIED:		APVD C RICHARD 03JUL2008	NAME TERMINAL BLOCK, MULTIPLE HEADER. 180 DEGREE, CLOSED ENDS, 5.08mm PITCH		
0 PLC ±- 1 PLC ±0.3 2 PLC ±0.25 3 PLC ±- 4 PLC ±- ANGLES ±2° FINISH		PRODUCT SPEC -	SIZE A2	CAGE CODE 00779	DRAWING NO C-284065
MATERIAL		APPLICATION SPEC 114-20079	RESTRICTED TO -	SCALE 5:1 SHEET 2 OF 4 REV E	
		WEIGHT -	CUSTOMER DRAWING		

REVISIONS

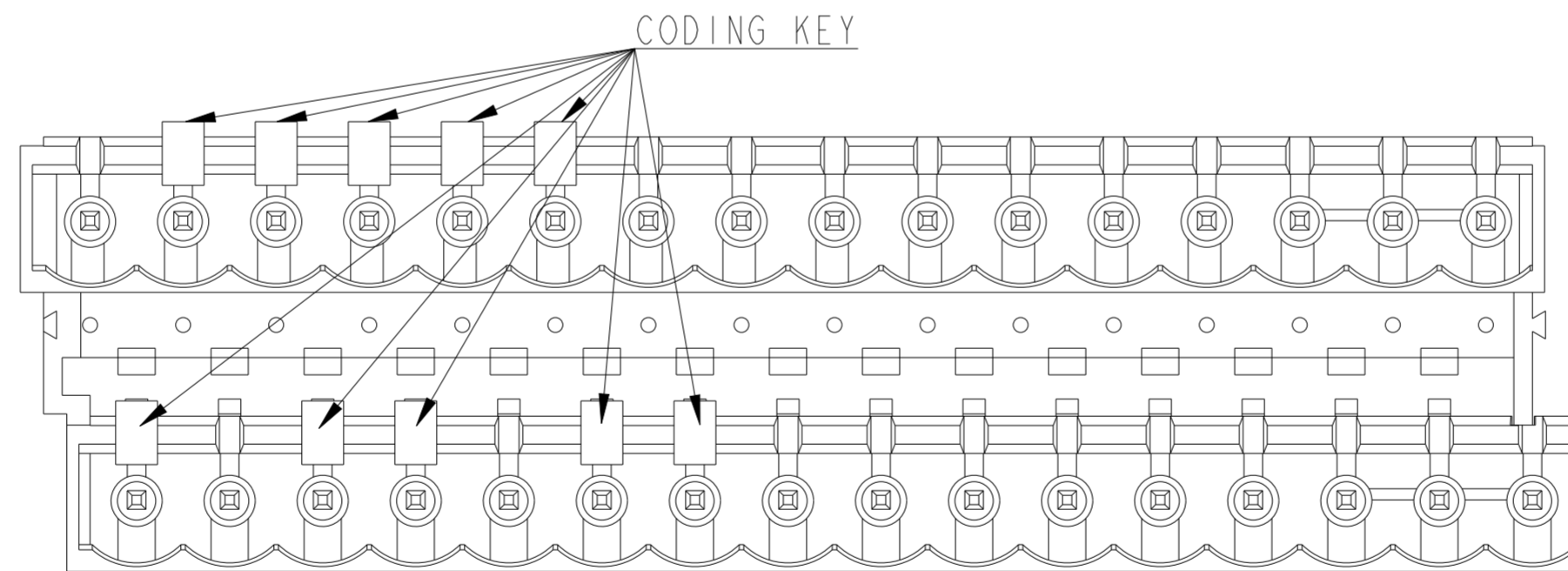
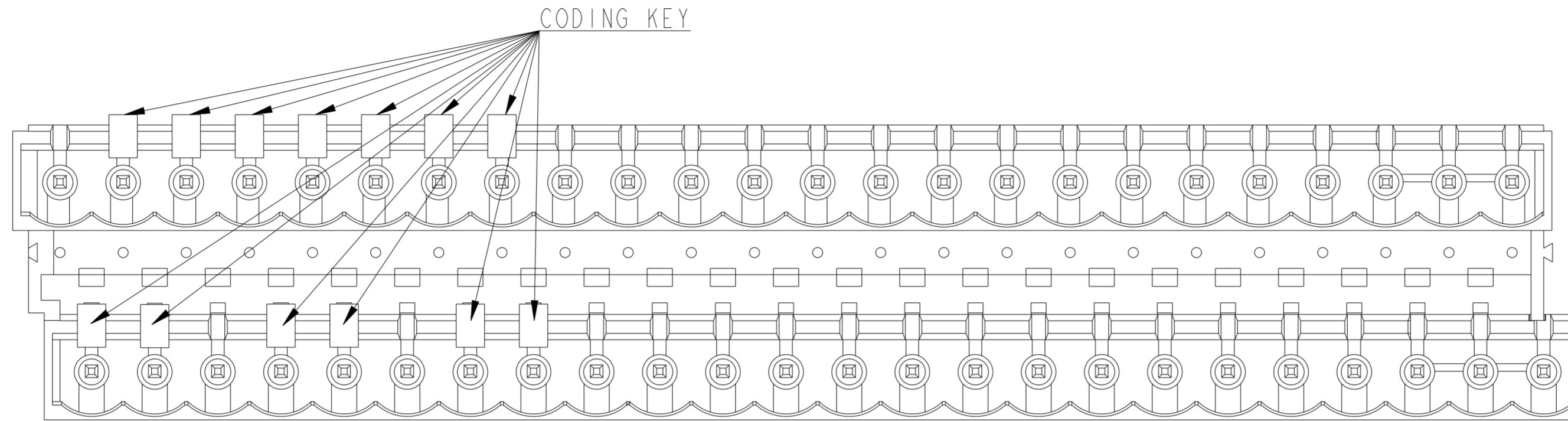
P	LTR	DESCRIPTION	DATE	DWN	APVD
-		SEE SHEET 1	-	-	-



THIS DRAWING IS A CONTROLLED DOCUMENT.		DWN S SCHLEGEL 07MAR2008	 TE Connectivity	
DIMENSIONS: mm		CHK C RICHARD 03JUL2008		
TOLERANCES UNLESS OTHERWISE SPECIFIED:		APVD C RICHARD 03JUL2008	NAME TERMINAL BLOCK, MULTIPLE HEADER. 180 DEGREE, CLOSED ENDS, 5.08mm PITCH	
0 PLC ±- 1 PLC ±0.3 2 PLC ±0.25 3 PLC ±- 4 PLC ±- ANGLES ±2° FINISH		PRODUCT SPEC -	SIZE A2	CAGE CODE 00779
MATERIAL		APPLICATION SPEC 114-20079	DRAWING NO C-284065	RESTRICTED TO -
		WEIGHT -	SCALE 5:1 SHEET 3 OF 4 REV E	
		CUSTOMER DRAWING		

REVISIONS

P	LTR	DESCRIPTION	DATE	DWN	APVD
-		SEE SHEET 1	-	-	-

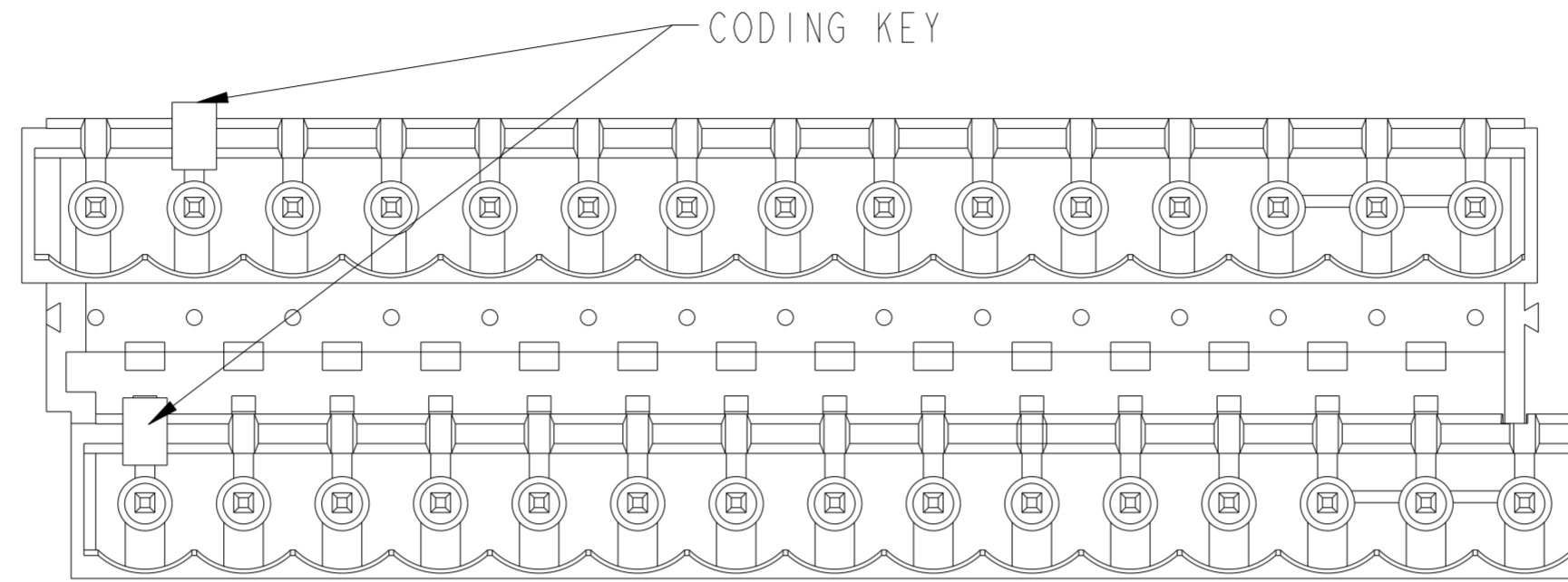

3-284065-2

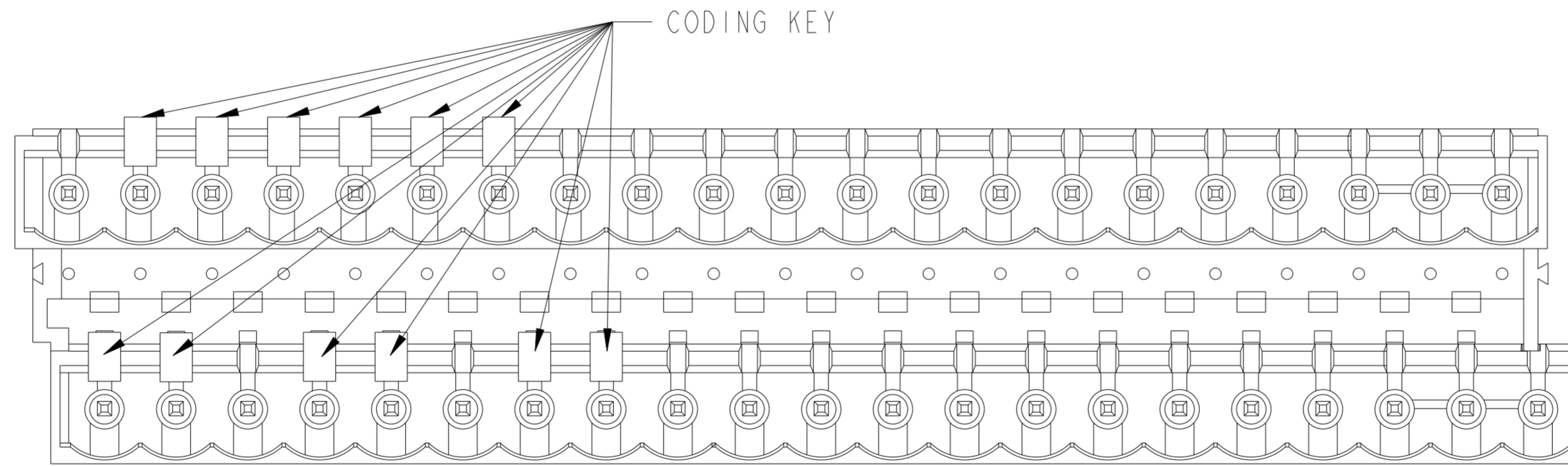

3-284065-3

THIS DRAWING IS A CONTROLLED DOCUMENT.		DWN S SCHLEGEL 07MAR2008	 TE Connectivity	
DIMENSIONS: mm		CHK C RICHARD 03JUL2008		
TOLERANCES UNLESS OTHERWISE SPECIFIED:		APVD C RICHARD 03JUL2008	NAME TERMINAL BLOCK, MULTIPLE HEADER. 180 DEGREE, CLOSED ENDS, 5.08mm PITCH	
0 PLC ±- 1 PLC ±0.3 2 PLC ±0.25 3 PLC ±- 4 PLC ±- ANGLES ±2° FINISH		PRODUCT SPEC -	SIZE A2	CAGE CODE 00779
MATERIAL		APPLICATION SPEC 114-20079	DRAWING NO C-284065	RESTRICTED TO -
		WEIGHT -	SCALE 5:1	SHEET 4 OF 4
		CUSTOMER DRAWING	REV E	

单击下面可查看定价，库存，交付和生命周期等信息

[>>TE Connectivity\(泰科\)](#)