

THIS DRAWING IS UNPUBLISHED. RELEASED FOR PUBLICATION 2007
 © COPYRIGHT 2007 BY - ALL RIGHTS RESERVED.

LOC J DIST

REVISIONS					
P	LTR	DESCRIPTION	DATE	DWN	APVD
C1		REVISED PER ECR-12-020340	05DEC2012	E.C	H.M
C2		REVISED PER ECR-17-005500	4MAY2017	N.W.	X.X
C3		REVISED PER ECR-17-009217	24JUL2017	K.T	E.T

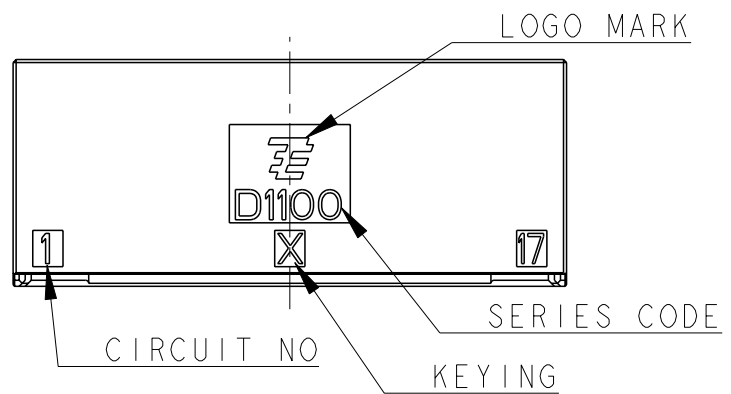
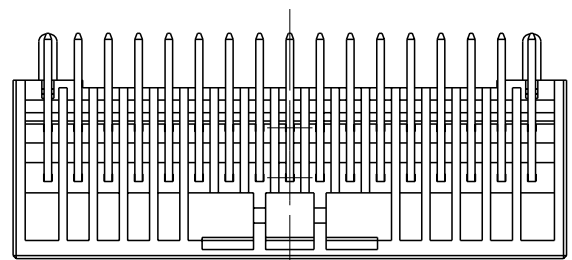
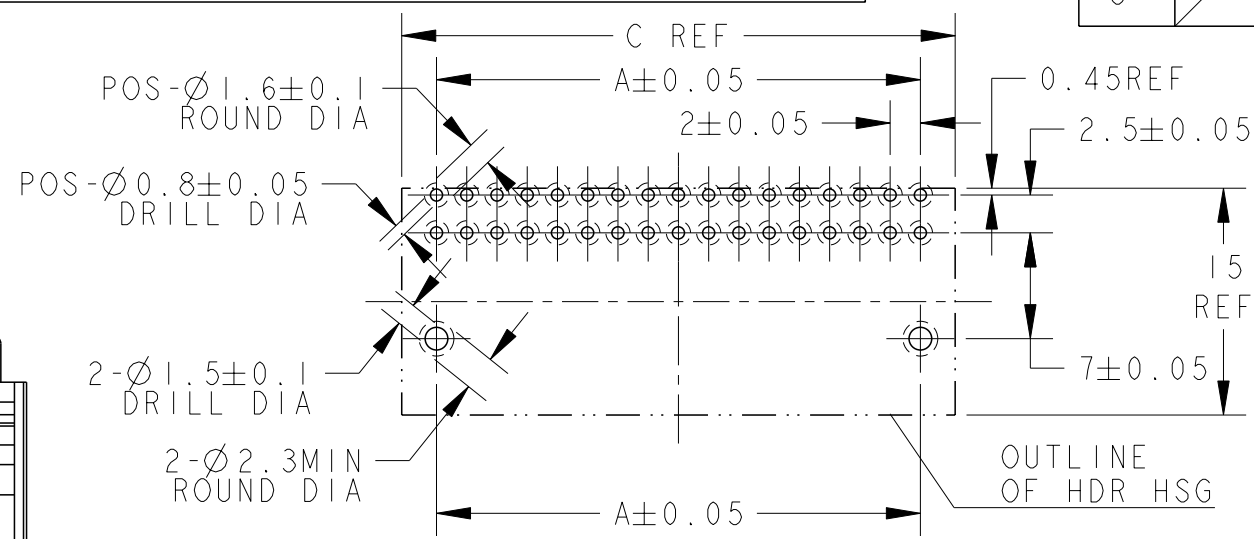

推奨基板取付寸法 : コネクタ搭載面(非累積公差)
 PC基板厚 : 1.0~1.6±0.1
 RECOMMEND PC BOARD HOLE PATTERN : CONNECTOR MOUNT SIDE
 (NOT ACCUMULATE TOLERANCE)
 PC BOARD THICKNESS : 1.0~1.6±0.1

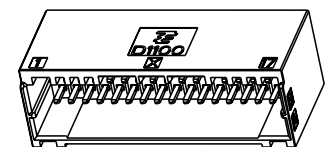

SCALE 1:1

- ①. 材料:ハウジング:ガラス入り熱可塑性ポリエステル樹脂(94V-0)、色:黒
 コンタクト:銅合金
 リテンションレグ:錫めっき済銅合金
- ②. めっき(全面):ニッケル下地めっき1.27μm以上
- ③. めっき(接触部):②の上に金めっき0.38μm以上、またはsn1.0μm MINめっき後
- ④. めっき(コンタクト半田付部):②の上に錫めっき2μm以上
- 5. 文字の形状、大きさ、および位置については、大略を示すものであり、詳細を示すものではありません。

- ①. MATERIAL:HOUSING:GLASS FILED THERMO PLASTIC POLYESTER(94V-0), COLOR:BLACK
 CONTACT:COPPER ALLOY
 RETENTION LEG:PRE-TIN COPPER ALLOY
- ②. FINISH(ALL OVER):NICKEL PLATING 1.27μmMIN
- ③. FINISH(CONTACT AREA):GOLD PLATING 0.38μmMIN OR Sn PLATING 1.0μmMIN AFTER ②
- ④. FINISH(CONTACT TAIL):TIN PLATING 2μmMIN AFTER ②
- 5. THE SHAPE, SIZE AND POSITION OF THE CHARACTER SHOW THE OUTLINE. THEY DON'T SHOW DETAILS.

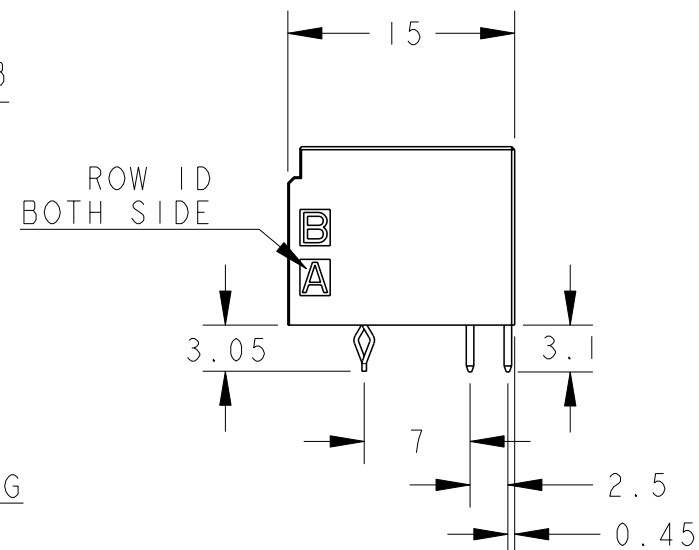
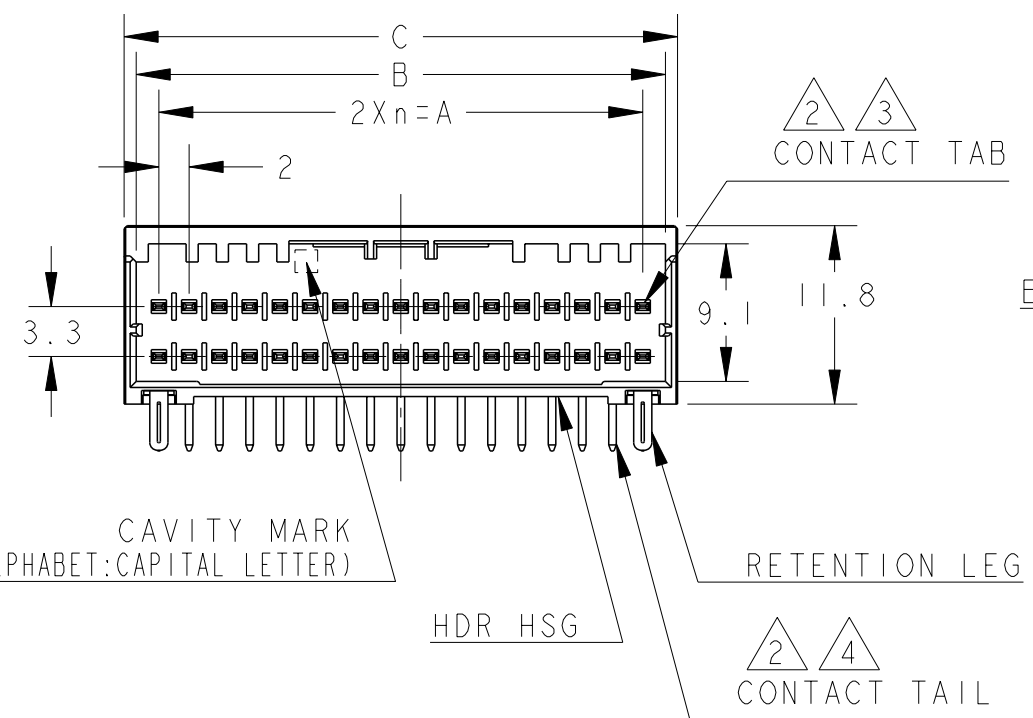

POS	KEY	n	A	B	C	FINISHED	PART NO
40	X	19	38.0	41.0	42.6	Sn PLATED	3-1939638-0
40	X	19	38.0	41.0	42.6	GOLD PLATED	1-1939638-0
34	X	16	32.0	35.0	36.6	Sn PLATED	3-1939638-7
34	X	16	32.0	35.0	36.6	GOLD PLATED	1-1939638-7
30	X	14	28.0	31.0	32.6	Sn PLATED	3-1939638-5
30	X	14	28.0	31.0	32.6	GOLD PLATED	1-1939638-5
28	X	13	26.0	29.0	30.6	Sn PLATED	3-1939638-4
28	X	13	26.0	29.0	30.6	GOLD PLATED	1-1939638-4
26	X	12	24.0	27.0	28.6	Sn PLATED	3-1939638-3
26	X	12	24.0	27.0	28.6	GOLD PLATED	1-1939638-3

34POS(X-KEY):1-1939638-7

THIS DRAWING IS A CONTROLLED DOCUMENT.

DWN M. MAEBASHI 30JUL2007
 CHK T. KUDO 30JUL2007
 APVD D. MITSUGI 30JUL2007

TE Connectivity

NAME DYNAMIC D1100D 2.0mmPITCH HDR ASSY, H-TYPE 22-40POS

PRODUCT SPEC 108-78268/78298
 APPLICATION SPEC 114-5377

SIZE A3 CAGE CODE 00779 DRAWING NO C-1939638 RESTRICTED TO -

Customer Drawing SCALE 2:1 SHEET 1 OF 2 REV C3

THIS DRAWING IS UNPUBLISHED.

RELEASED FOR PUBLICATION

2007

© COPYRIGHT 2007 BY -

ALL RIGHTS RESERVED.

LOC
J

DIST

REVISIONS

P	LTR	DESCRIPTION	DATE	DWN	APVD
		SEE SHEET 1 OF 2			

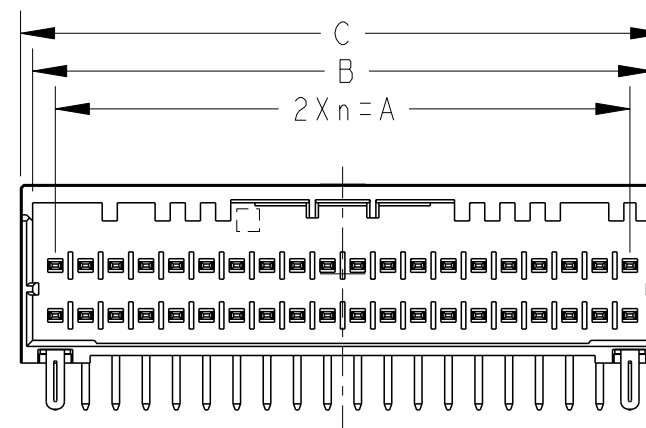
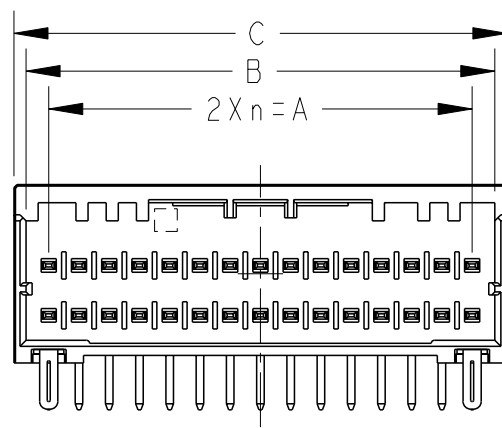
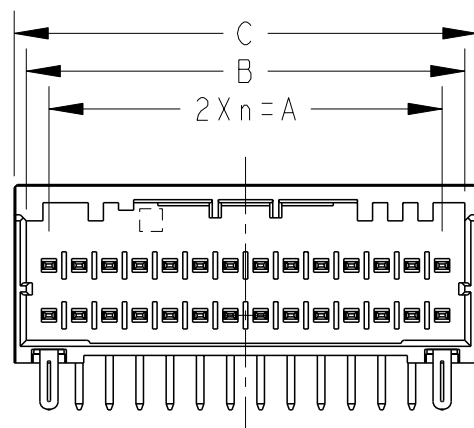
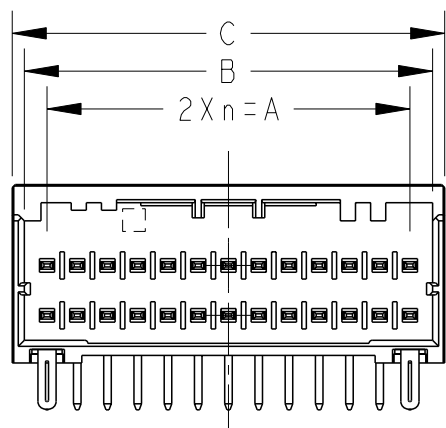
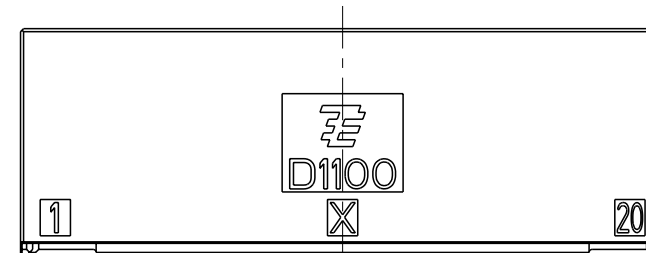
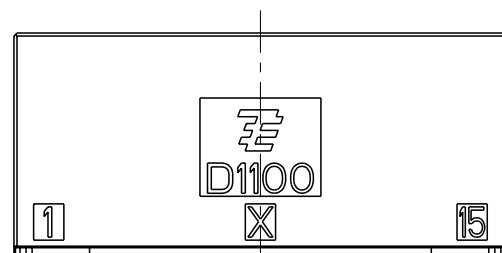
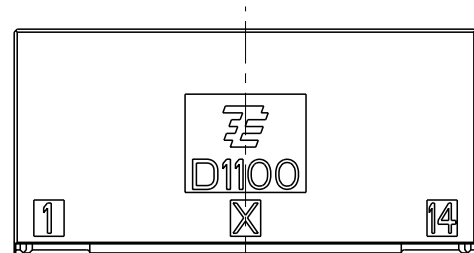
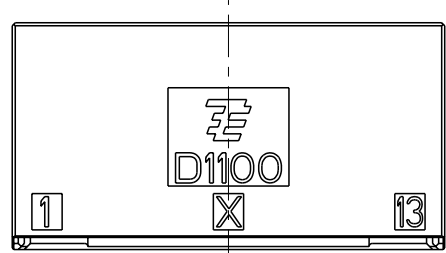
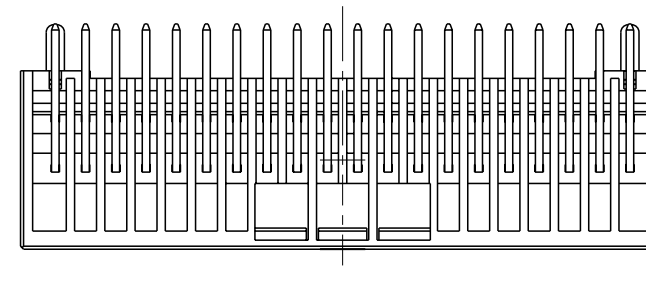
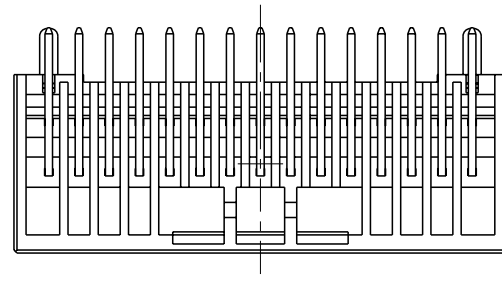
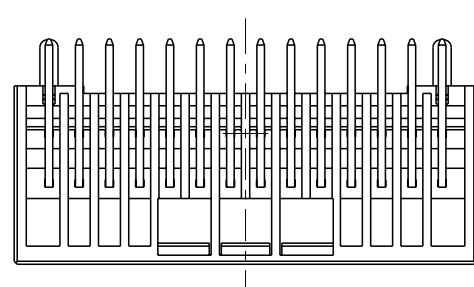
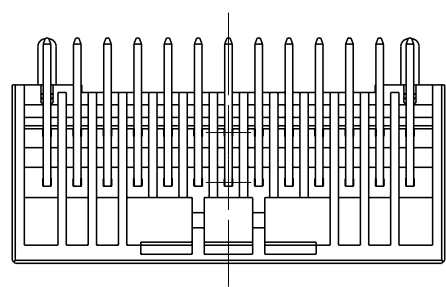

26POS(X-KEY): 1-1939638-3

28POS(X-KEY): 1-1939638-4

30POS(X-KEY): 1-1939638-5

40POS(X-KEY): 1-1939638-0

THIS DRAWING IS A CONTROLLED DOCUMENT.

DIMENSIONS:
mm

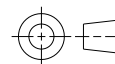

TOLERANCES UNLESS OTHERWISE SPECIFIED:

- 0 PLC ±
- 1 PLC ±0.5
- 2 PLC ±0.13
- 3 PLC ±0.013
- 4 PLC ±0.0001
- ANGLES ±

MATERIAL

FINISH

DWN 30JUL2007

M. MAEBASHI

CHK 30JUL2007

T. KUDO

APVD 30JUL2007

D. MITSUGI

PRODUCT SPEC

108-78268/78298

APPLICATION SPEC

114-5377

WEIGHT

-

Customer Drawing



TE Connectivity

NAME
DYNAMIC D1100D 2.0mmPITCH
HDR ASSY, H-TYPE
22-40POS

SIZE CAGE CODE DRAWING NO RESTRICTED TO

A300779 C-1939638

SCALE 2:1

SHEET 2 OF 2

REV C3

单击下面可查看定价，库存，交付和生命周期等信息

[>>TE Connectivity\(泰科\)](#)