

THIS DRAWING IS UNPUBLISHED. RELEASED FOR PUBLICATION
 © COPYRIGHT - TE Connectivity ALL RIGHTS RESERVED.

REVISIONS				
P	LTR	DESCRIPTION	DATE	APVD
E2		ECR-18-002718	23FEB2018	M.G D.Z

(2 POS.)

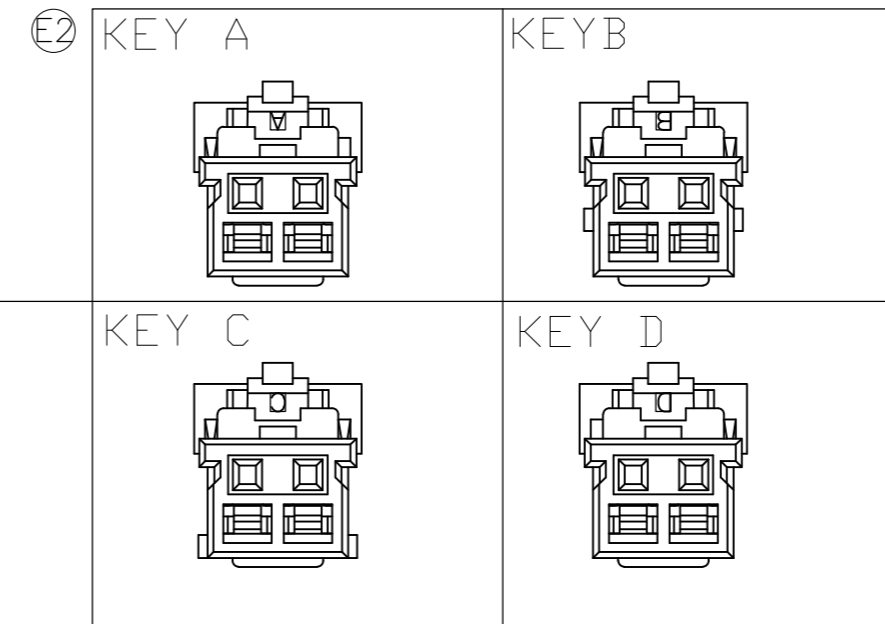
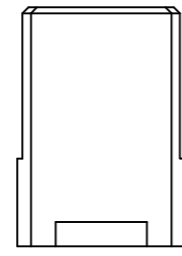

NOTE:
 1. GENERAL TOLERANCE: ± 0.3 , $\pm 3^\circ$
 2. MATERIAL: 66NYLON GF(UL94V-0)
 3. MATING CONN. P/N: SEE TABLE
 4. APPLICABLE CONTACT P/N:
 1971031-1

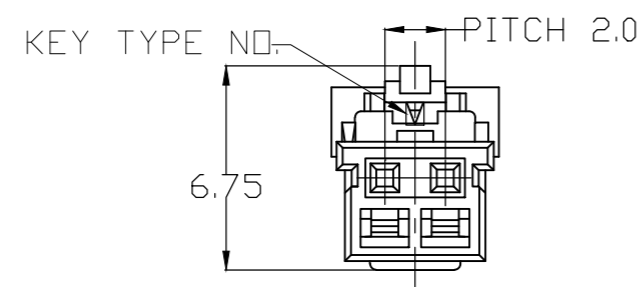
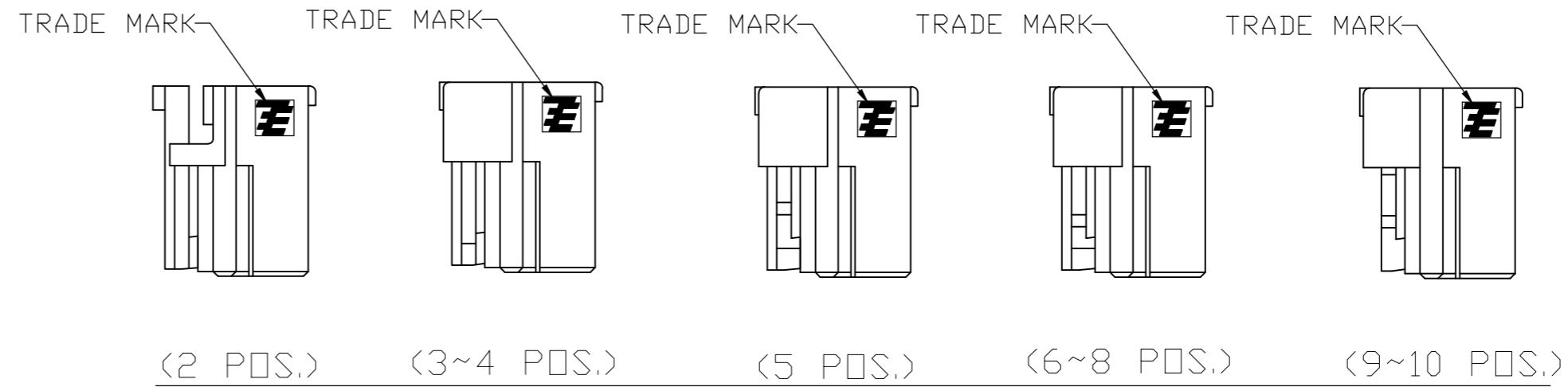
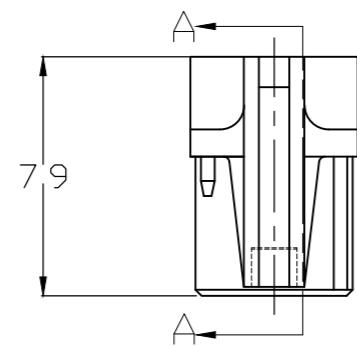
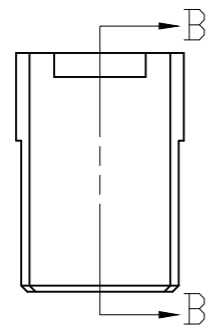
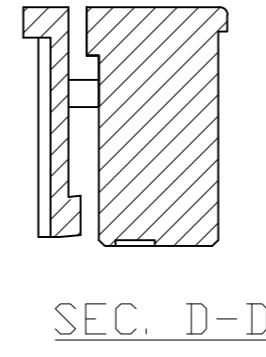
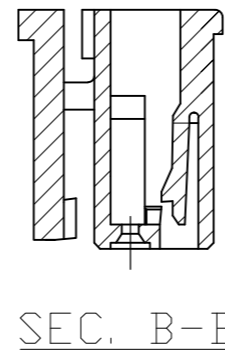
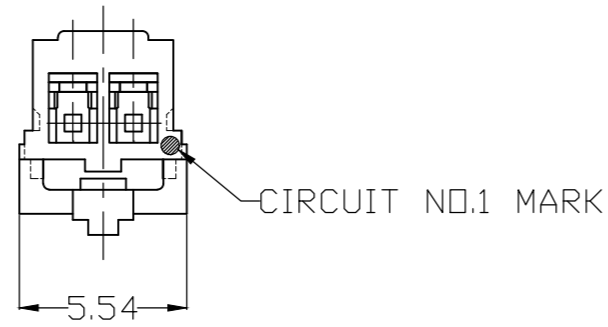

THIS DRAWING IS A CONTROLLED DOCUMENT.		DWN Liu Jimmy 11JUN2008														
DIMENSIONS: mm		CHK Wu hapye 11JUN2008														
TOLERANCES UNLESS OTHERWISE SPECIFIED:		APVD Zhou Julian 11JUN2008	NAME Grace Inertia Connector 2.0 EV Series Plug Housing													
<table border="1"> <tr><td>0 PLC</td><td>±</td></tr> <tr><td>1 PLC</td><td>±</td></tr> <tr><td>2 PLC</td><td>±</td></tr> <tr><td>3 PLC</td><td>±</td></tr> <tr><td>4 PLC</td><td>±</td></tr> <tr><td>ANGLES</td><td>±</td></tr> </table>		0 PLC	±	1 PLC	±	2 PLC	±	3 PLC	±	4 PLC	±	ANGLES	±	PRODUCT SPEC 108-106001	SIZE A2	CAGE CODE 00779
0 PLC	±															
1 PLC	±															
2 PLC	±															
3 PLC	±															
4 PLC	±															
ANGLES	±															
MATERIAL SEE NOTE		FINISH -	APPLICATION SPEC 114-5425	DRAWING NO C=1971030												
		WEIGHT 0	RESTRICTED TO -													
		CUSTOMER DRAWING	SCALE 4:1	SHEET 1 of 3												
			REV E2													

THIS DRAWING IS UNPUBLISHED. RELEASED FOR PUBLICATION
 © COPYRIGHT - TE Connectivity ALL RIGHTS RESERVED.

REVISIONS				
P	LTR	DESCRIPTION	DATE	APVD
-	-	SEE SHEET 1	-	-

(3 POS.)

(4 POS.)

(5 POS.)

(6 POS.)

(7 POS.)

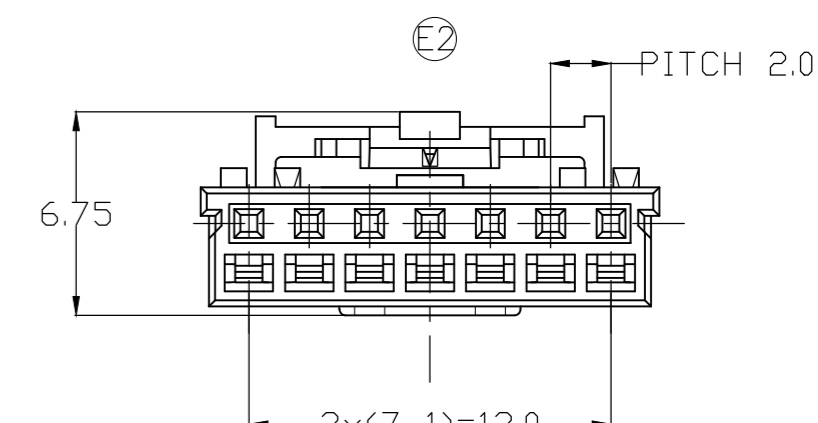
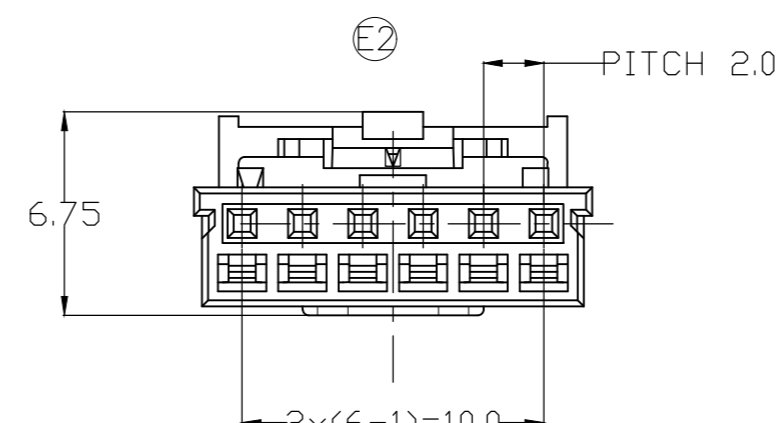
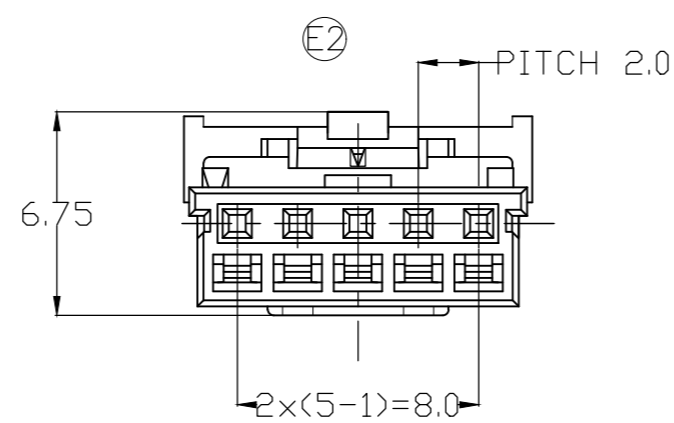
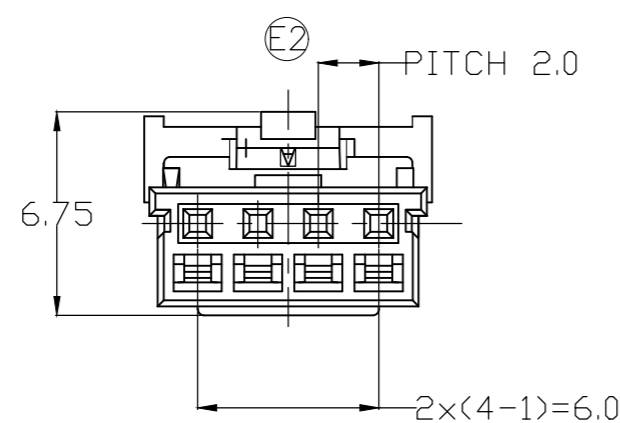
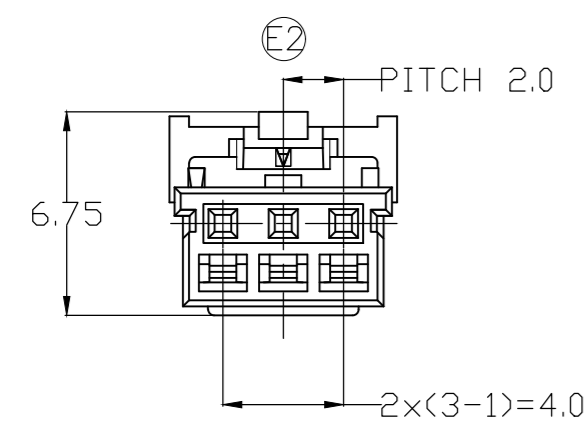
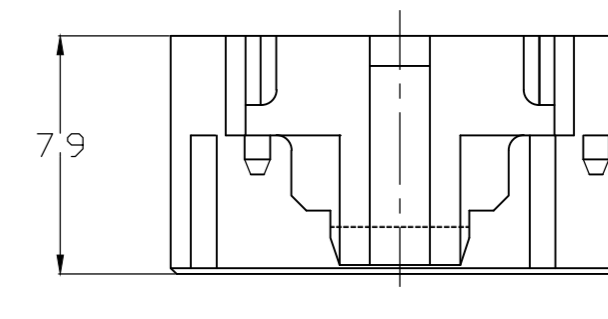
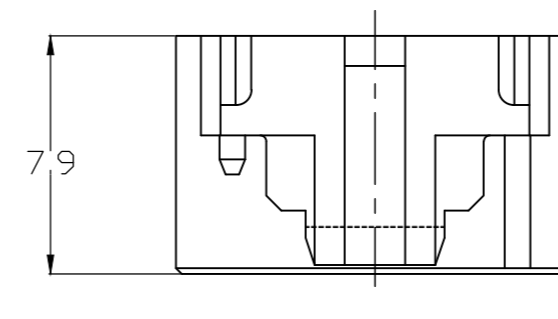
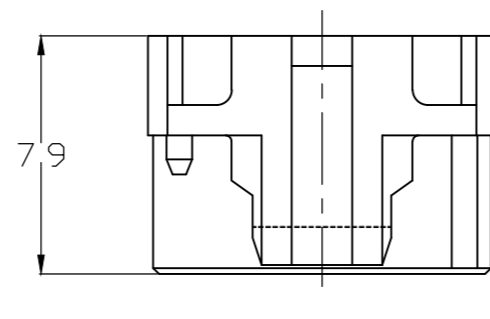
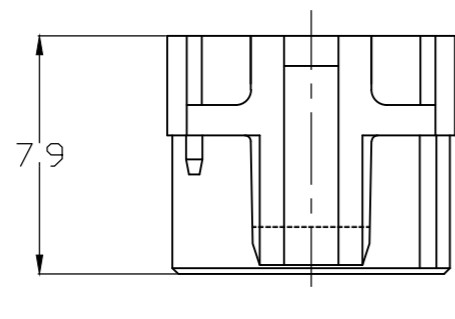
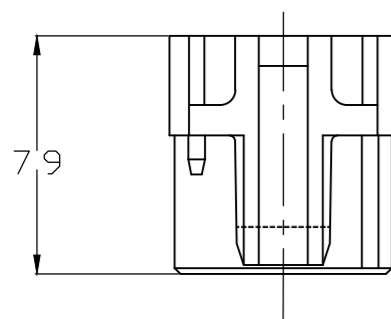
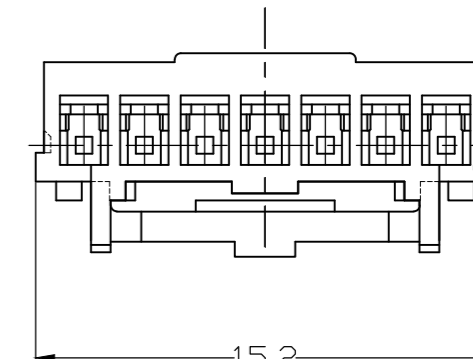
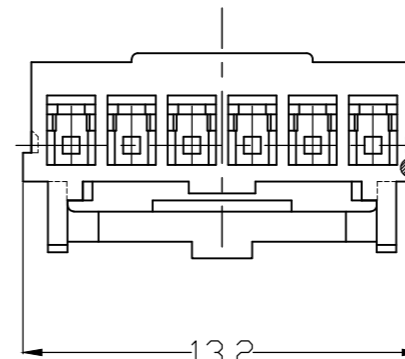
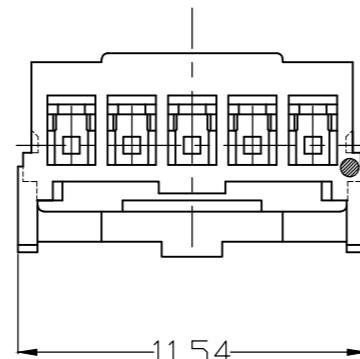
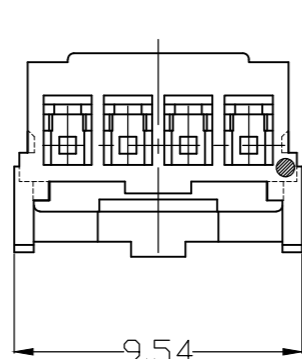
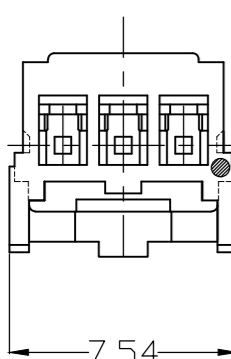
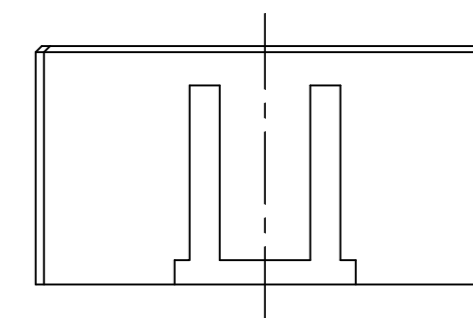
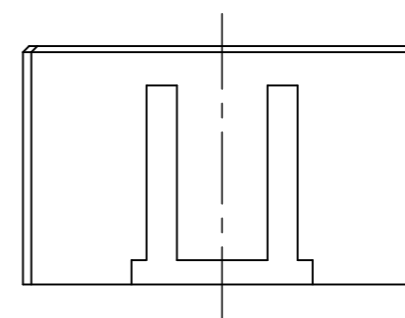
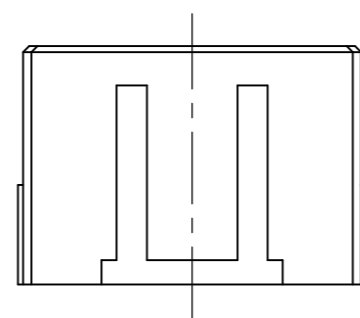
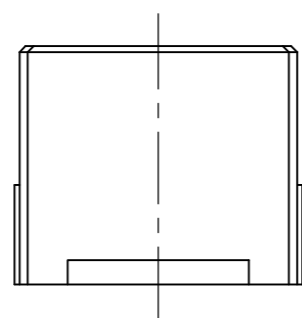
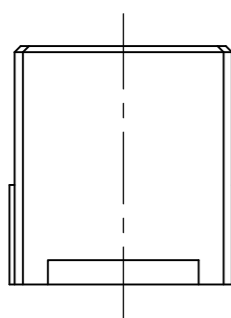

THIS DRAWING IS A CONTROLLED DOCUMENT.		DWN Liu Jimmy 11JUN2008	TE Connectivity		
DIMENSIONS: mm		CHK Wu Hapye 11JUN2008			
		APVD Zhou Julian 11JUN2008	NAME Grace Inertia Connector 2.0 EV Series Plug Housing		
TOLERANCES UNLESS OTHERWISE SPECIFIED: 0 PLC ± 1 PLC ± 2 PLC ± 3 PLC ± 4 PLC ± ANGLES ±		PRODUCT SPEC 108-106001	SIZE A2	CAGE CODE 00779	DRAWING NO. C-1971030
MATERIAL -		FINISH -	WEIGHT -	RESTRICTED TO -	
CUSTOMER DRAWING			SCALE 4:1	SHEET 2 of 3	REV E2

THIS DRAWING IS UNPUBLISHED. RELEASED FOR PUBLICATION
 © COPYRIGHT - TE Connectivity ALL RIGHTS RESERVED.

REVISIONS					
P	LTR	DESCRIPTION	DATE	DWN	APVD
-	-	SEE SHEET 1	-	-	-

(8 POS.)

(9 POS.)

(10 POS.)

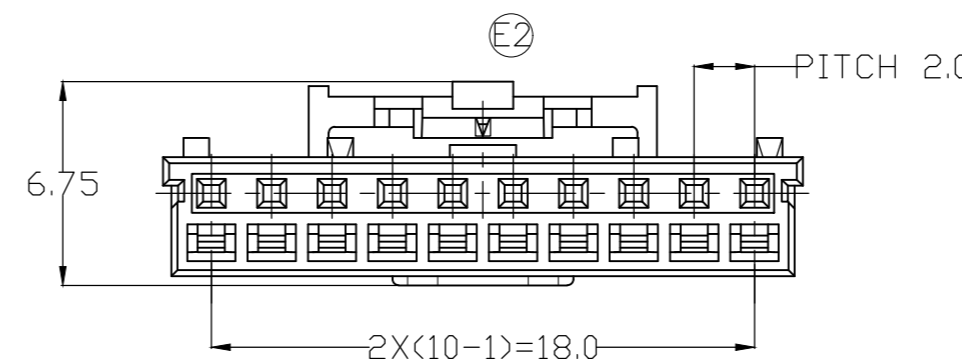
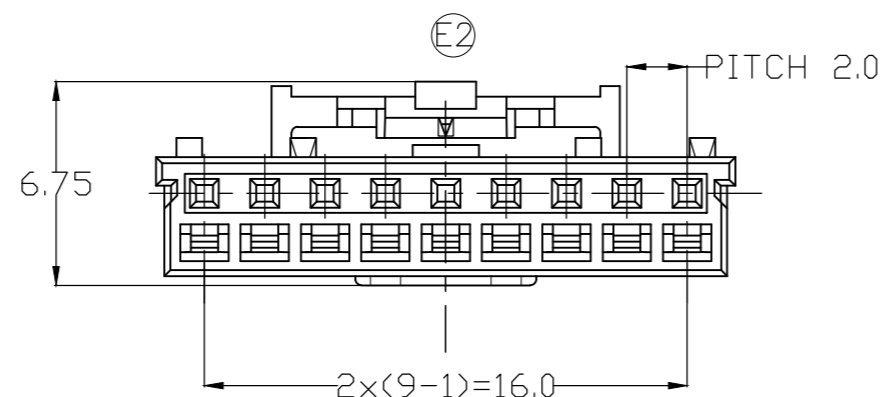
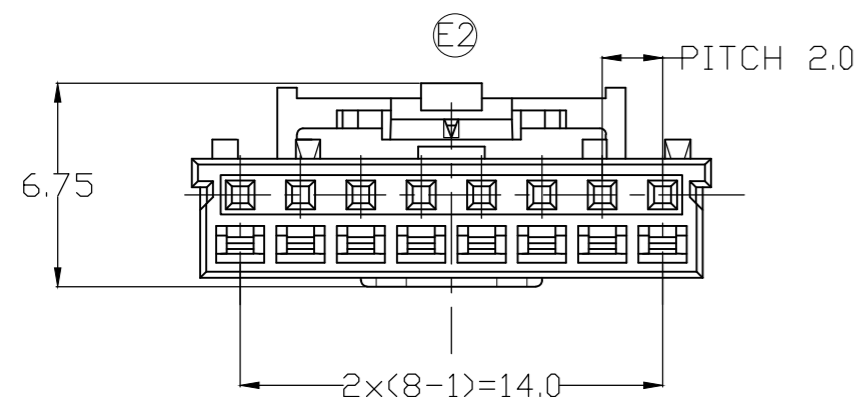
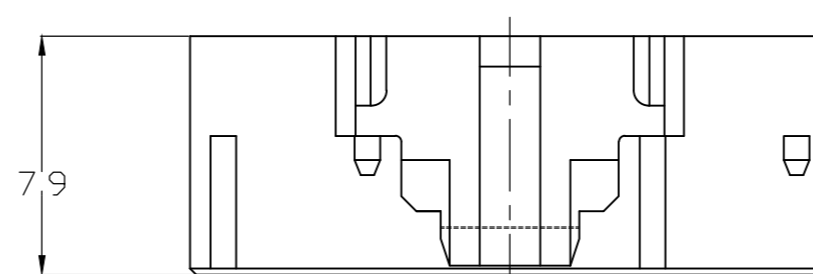
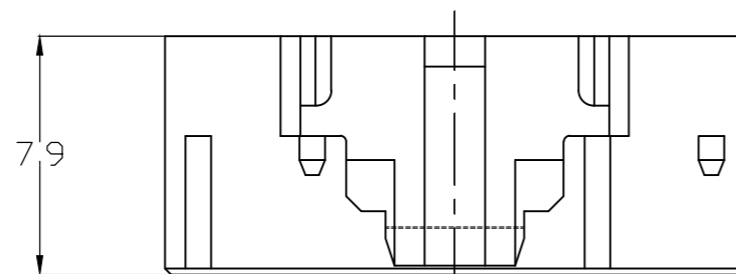
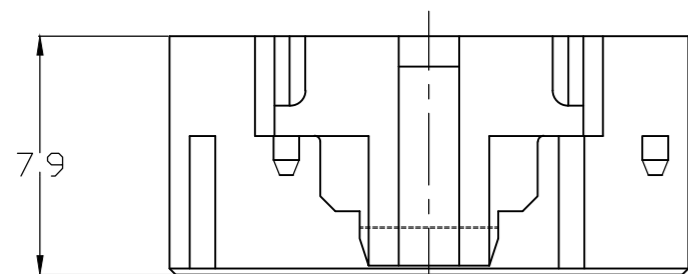
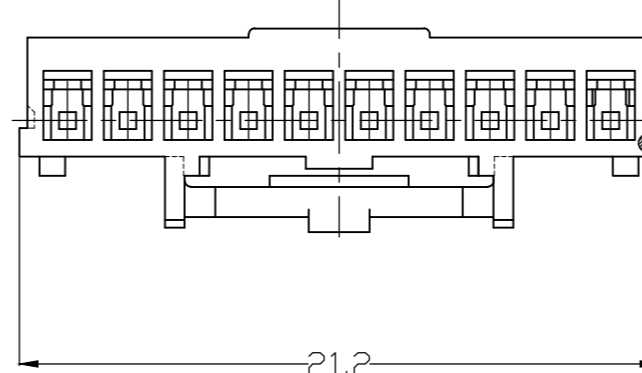
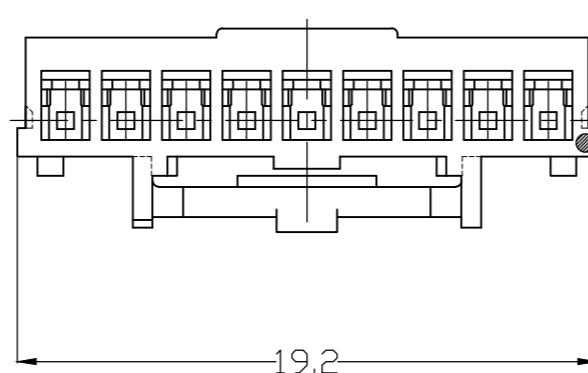
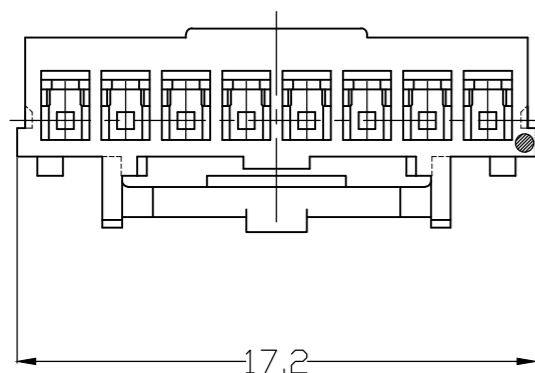
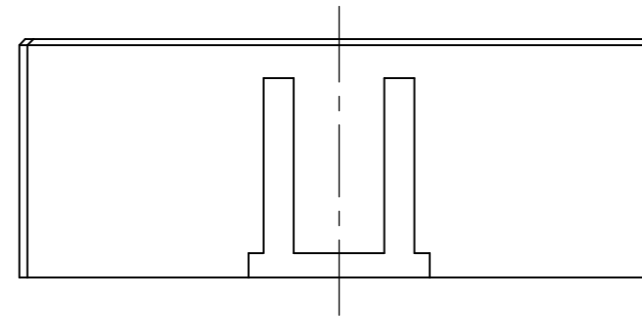
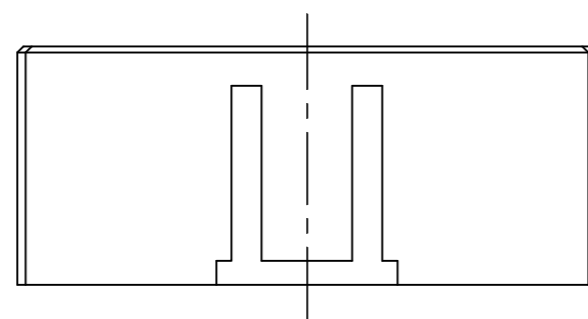
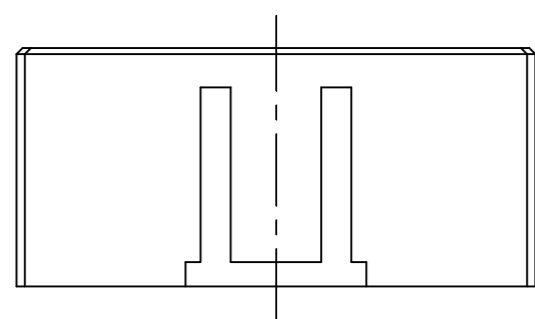

MATING CONNECTOR PART NUMBER	KEY TYPE	COLOR	POS.	PART NUMBER
3-1971032-1	D	YELLOW	10	3-1971030-1
2-1971032-1	C	BLUE		2-1971030-1
1-1971032-1	B	RED		1-1971030-1
1971032-1	A	NATURAL		1971030-1
3-1971032-9	D	YELLOW	9	3-1971030-9
2-1971032-9	C	BLUE		2-1971030-9
1-1971032-9	B	RED		1-1971030-9
1971032-9	A	NATURAL		1971030-9
3-1971032-8	D	YELLOW	8	3-1971030-8
2-1971032-8	C	BLUE		2-1971030-8
1-1971032-8	B	RED		1-1971030-8
1971032-8	A	NATURAL		1971030-8
3-1971032-7	D	YELLOW	7	3-1971030-7
2-1971032-7	C	BLUE		2-1971030-7
1-1971032-7	B	RED		1-1971030-7
1971032-7	A	NATURAL		1971030-7
3-1971032-6	D	YELLOW	6	3-1971030-6
2-1971032-6	C	BLUE		2-1971030-6
1-1971032-6	B	RED		1-1971030-6
1971032-6	A	NATURAL		1971030-6
4-1971032-5	E	BLACK	5	4-1971030-5
3-1971032-5	D	YELLOW		3-1971030-5
2-1971032-5	C	BLUE		2-1971030-5
1-1971032-5	B	RED		1-1971030-5
1971032-5	A	NATURAL		1971030-5
3-1971032-4	D	YELLOW	4	3-1971030-4
2-1971032-4	C	BLUE		2-1971030-4
1-1971032-4	B	RED		1-1971030-4
1971032-4	A	NATURAL		1971030-4
3-1971032-3	D	YELLOW	3	3-1971030-3
2-1971032-3	C	BLUE		2-1971030-3
1-1971032-3	B	RED		1-1971030-3
1971032-3	A	NATURAL		1971030-3
4-1971032-2	E	BLACK	2	4-1971030-2
3-1971032-2	D	YELLOW		3-1971030-2
2-1971032-2	C	BLUE		2-1971030-2
1-1971032-2	B	RED		1-1971030-2
1971032-2	A	NATURAL		1971030-2

THIS DRAWING IS A CONTROLLED DOCUMENT.

DIMENSIONS: mm

TOLERANCES UNLESS OTHERWISE SPECIFIED:

0 PLC	±
1 PLC	±
2 PLC	±
3 PLC	±
4 PLC	±
ANGLES	±
FINISH	-

MATERIAL: SEE NOTE

APPROVALS:

DWN	Liu Jimmy	11JUN2008
CHK	Wu Sam	11JUN2008
APVD	Zhou Julian	11JUN2008

PRODUCT SPEC: 108-106001

APPLICATION SPEC: 114-5425

WEIGHT: -

CUSTOMER DRAWING

TE Connectivity

Grace Inertia Connector 2.0 EV Series Plug Housing

SIZE: A2 CAGE CODE: 00779 DRAWING NO: 1971030 RESTRICTED TO: -

SCALE: 4:1 SHEET: 3 of 3 REV: E2

单击下面可查看定价，库存，交付和生命周期等信息

[>>TE Connectivity\(泰科\)](#)