

LOC		DIST		REVISIONS				
P	LTR	DESCRIPTION			DATE	DWN	APVD	
A		FIRST VERSION			12DEC2016	G.F	SM	

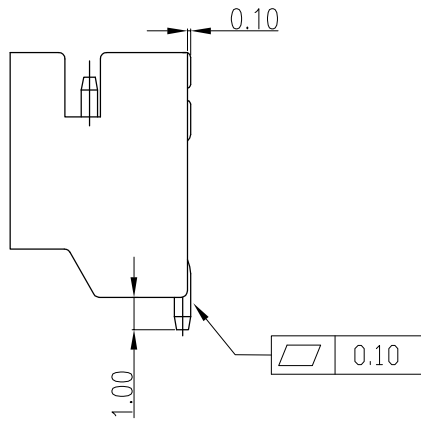
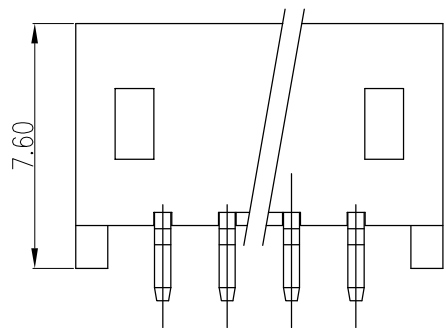
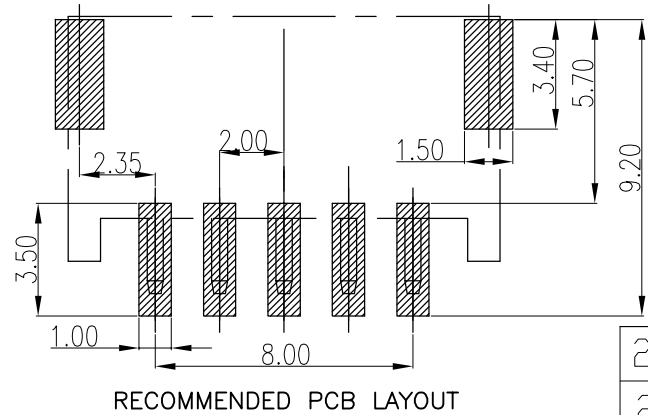
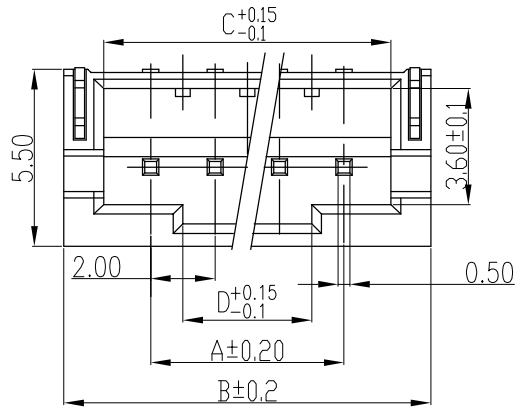

- MATERIAL:
  - INSULATION: THERMALPLATIC, UL 94V-0 COLOR:NATURAL
  - CONTACT: COPPER ALLOY
- FINISH: CONTACT 80u"MIN TIN-PLATED OVER 30u" MIN NICKEL PLATED
- INSULATION RESISTANCE:1000M ohm/MIN
- WITHSTAND VOLTAGE:800VAC/MIN
- CURRENT RATING:3A AC/DC
- VOLTAGE RATING:100V AC/DC
- REFLOW SOLDER CAPABLE TO 265°C

28.00	32.90	35.40	30.00	16P	2-2834187-6
26.00	30.90	33.40	28.00	15P	2-2834187-5
24.00	28.90	31.40	26.00	14P	2-2834187-4
22.00	26.90	29.40	24.00	13P	2-2834187-3
20.00	24.90	27.40	22.00	12P	2-2834187-2
18.00	22.90	25.40	20.00	11P	2-2834187-1
16.00	20.90	23.40	18.00	10P	1-2834187-9
14.00	18.90	21.40	16.00	9P	1-2834187-8
12.00	16.90	19.40	14.00	8P	1-2834187-7
10.00	14.90	17.40	12.00	7P	1-2834187-6
8.00	12.90	15.40	10.00	6P	1-2834187-5
6.00	10.90	13.40	8.00	5P	1-2834187-4
4.00	8.90	11.40	6.00	4P	1-2834187-3
2.00	6.90	9.40	4.00	3P	1-2834187-2
0.60	4.90	7.40	2.00	2P	1-2834187-1
D	C	B	A	POS	P/N

THIS DRAWING IS A CONTROLLED DOCUMENT.		DWG GEORGE FU 12DEC2016		TE Connectivity	
DIMENSIONS: P/M		CHK SHI MING 12DEC2016			
TOLERANCES UNLESS OTHERWISE SPECIFIED		APVD XU XIANG 12DEC2016		NAME	
D PLC ± E PLC ±0.30 F PLC ±0.20 G PLC ±0.1 H PLC ± ANGLES 45°		PRODUCT SPEC		2.0PITCH R/A SMT TYPE SINGLE ROW RECEPTACLE	
MATERIAL		FINISH		APPLICATION SPEC	
NOTE 1		NOTE 2		108-137153	
				114-137153	
				SIZE   CAGE CODE   DRAWING NO	
				A200779   C-2834187	
				RESTRICTED TO	
				CUSTOMER DRAWING	
				SCALE 1:1   SHEET 1 OF 2   REV A	

LOC		DIST		REVISIONS			
P	LTR	DESCRIPTION		DATE	DWN	APVD	

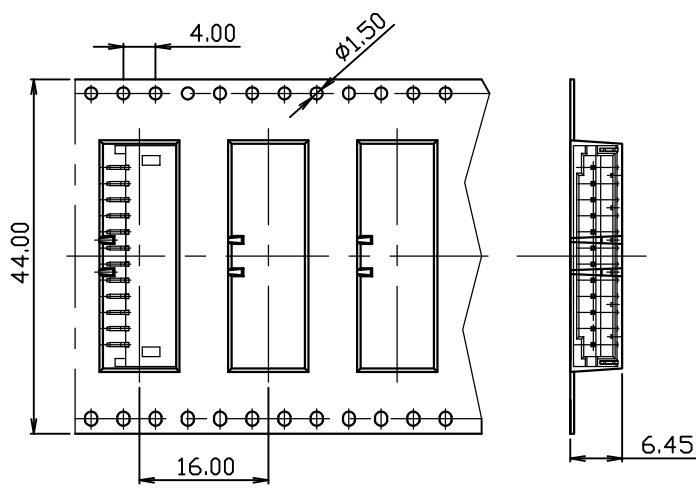
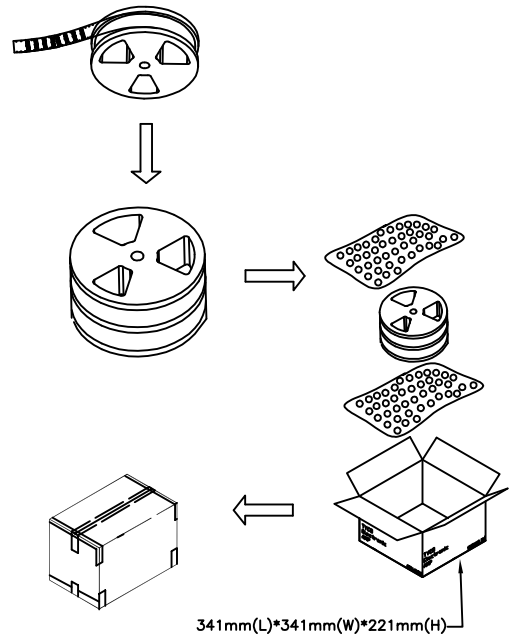
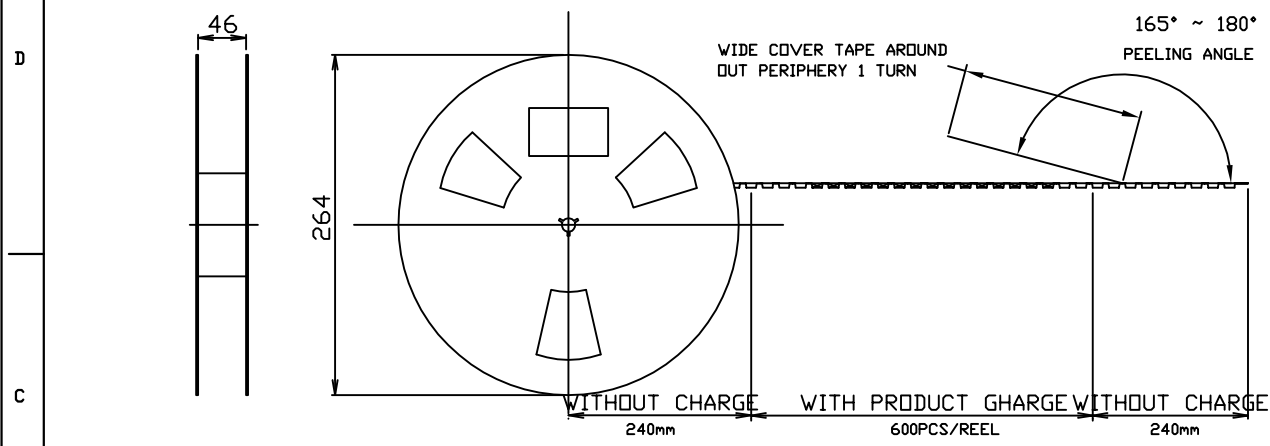

1800	600	16
1800	600	15
1800	600	14
1800	600	13
2400	600	12
2400	600	11
2400	600	10
2400	600	9
2400	600	8
2400	600	7
3000	600	6
3000	600	5
3000	600	4
3000	600	3
3000	600	2
PCS/CARTON	PCS/REEL	POS

THIS DRAWING IS A CONTROLLED DOCUMENT.		DWG GEORGE FU 12DEC2016		TE Connectivity	
DIMENSIONS: MPM		CHK SHI MING 12DEC2016			
TOLERANCES UNLESS OTHERWISE SPECIFIED		APVD XU XIANG 12DEC2016		NAME	
D PLC ±0.35		PRODUCT SPEC		2.0PITCH R/A SMT TYPE	
E PLC ±0.30		108-137153		SINGLE ROW RECEPTACLE	
F PLC ±0.20		APPLICATION SPEC		SIZE CAGE CODE DRAWING NO	
G PLC ±0.1		114-137153		A2 00779 C-2834187	
H PLC ±		WEIGHT		RESTRICTED TO	
ANGLES ±		CUSTOMER DRAWING		SCALE 1:1 SHEET 2 OF 2 REV A	

单击下面可查看定价，库存，交付和生命周期等信息

[>>TE Connectivity\(泰科\)](#)