

4

3

2

1

THIS DRAWING IS UNPUBLISHED. RELEASED FOR PUBLICATION 20
© COPYRIGHT 20 BY - ALL RIGHTS RESERVED.

REVISIONS				
P	LYR	DESCRIPTION	DATE	DWN APVD
4		INITIAL RELEASE	07AUG2020	F.F. M.S.

AS SHOWN: 1-2834465-2

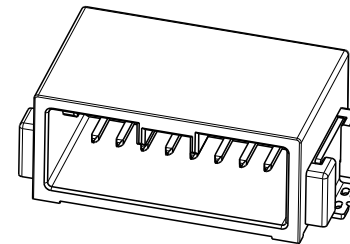
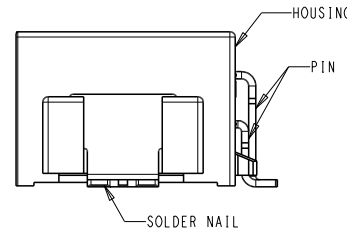
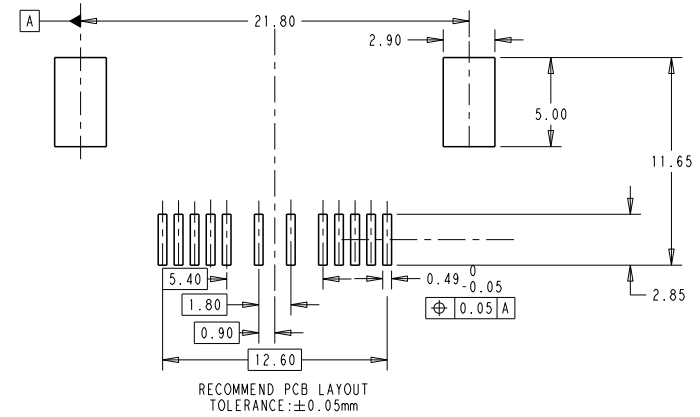
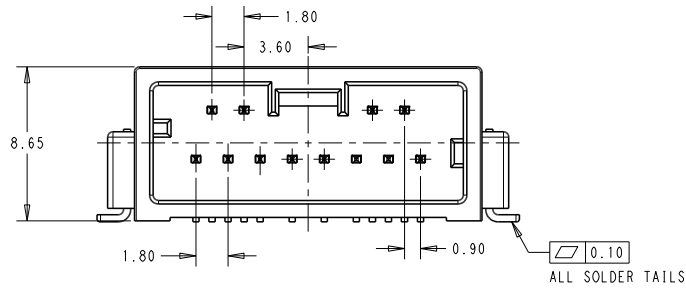
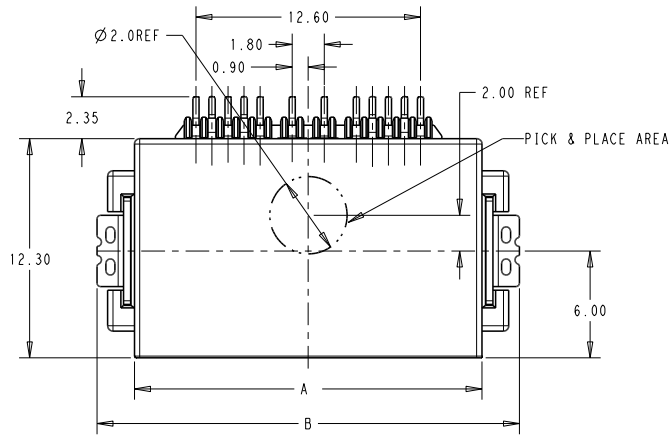

NOTES :

- MATERIAL:
HOUSING: HIGH TEMPERATURE THERMO PLASTIC, COLOR BLACK.
PIN: COPPER ALLOY.
SOLDER NAIL: BRASS.
- FINISH:
PIN: TIN PLATING OVER NICKEL PLATING OVERALL.
SOLDER NAIL: TIN PLATING OVER NICKEL PLATING OVERALL.
- PACKAGED IN TAPE AND REEL INSIDE OF CARTON.

31.10	26.70	20	2-2834465-0
27.50	23.10	16	1-2834465-6
23.90	19.50	12	1-2834465-2
DIMENSION B	DIMENSION A	POSITION	PN

DIMENSIONS:		TOLERANCES UNLESS OTHERWISE SPECIFIED:		DWN		TE Connectivity	
mm	0 PLC ±	1 PLC ±	2 PLC ±0.25	FRANK FAN	07AUG2020	MINIDYNAMIC HEADER	
	3 PLC ±	4 PLC ±	FINISH	CHV	07AUG2020	1.8 MM PITCH SMT TYPE	
	ANGLES			APVD	07AUG2020	NAME	
MATERIAL				GEORGE FU		PRODUCT SPEC	
				MING SHI		108-137443	
						APPLICATION SPEC	
						SIZE	CAGE CODE DRAWING NO
						A2	2834465
						RESTRICTED TO	
						CUSTOMER DRAWING	SCALE 4:1 SHEET 1 OF 2 REV 4

4

3

2

1

THIS DRAWING IS UNPUBLISHED. RELEASED FOR PUBLICATION 20
© COPYRIGHT 20 BY - ALL RIGHTS RESERVED.

REVISIONS				
P	LYR	DESCRIPTION	DATE	APVD
		SEE SHEET 1		

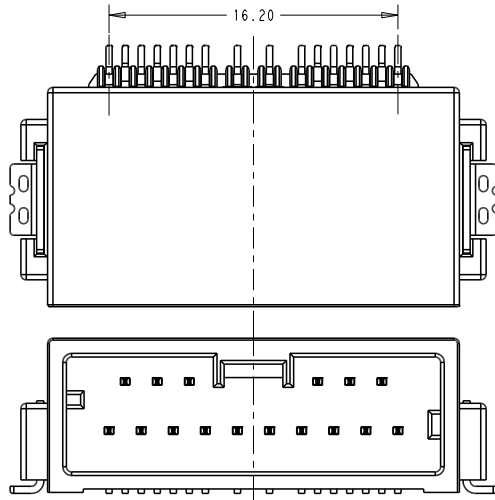

1-2834465-6

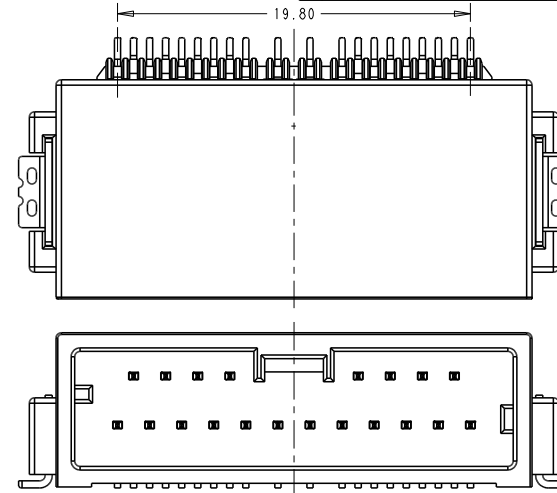

2-2834465-0

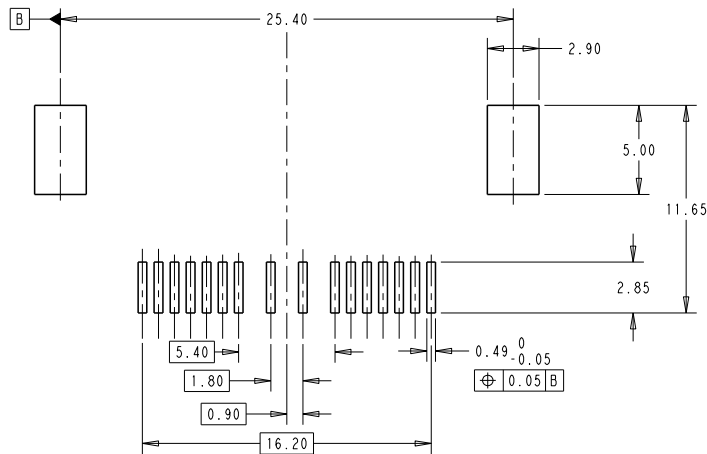

RECOMMEND PCB LAYOUT
TOLERANCE: ±0.05mm

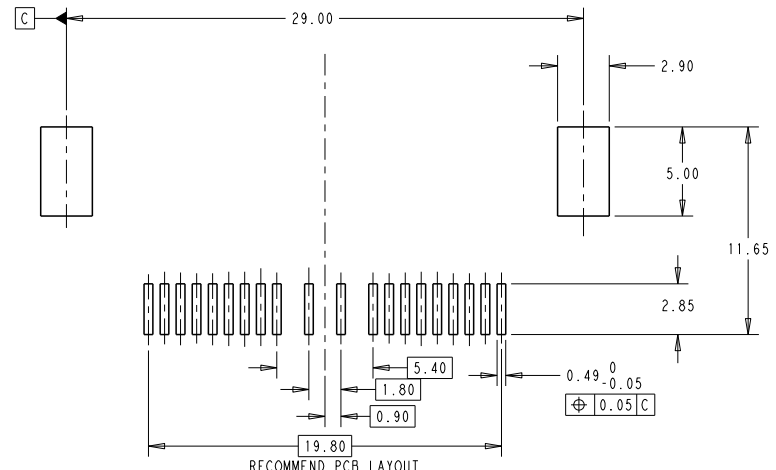

RECOMMEND PCB LAYOUT
TOLERANCE: ±0.05mm

THIS DRAWING IS A CONTROLLED DOCUMENT.		DWN: FRANK FAN 07AUG2020		
		CHK: GEORGE FU 07AUG2020		
DIMENSIONS: mm		APVD: MING SHI 07AUG2020	NAME: MINIDYNAMIC HEADER	RESTRICTED TO
TOLERANCES UNLESS OTHERWISE SPECIFIED:		PRODUCT SPEC: 108-137443	1.8 MM PITCH SMT TYPE	
0 PLC ± 1 PLC ± 2 PLC ±0.25 3 PLC ± 4 PLC ± ANGLES ± FINISH ±		APPLICATION SPEC: -	SIZE: A2	CAGE CODE: -
MATERIAL: -		WEIGHT: -	DRAWING NO: C=2834465	SCALE: 3:1
		CUSTOMER DRAWING	SHEET: 2 of 2	REV: 4

单击下面可查看定价，库存，交付和生命周期等信息

[>>TE Connectivity\(泰科\)](#)