

TLV703x 和 TLV704x 小尺寸、毫微功耗、低电压比较器

1 特性

- 超小型 X2SON、WSON、WQFN 封装
- 微型 SOT-23、SC70、VSSOP 和 TSSOP 封装
- 1.6V 至 6.5V 的宽电源电压范围
- 315nA 静态电源电流
- 3 μ s 低传播延迟
- 轨到轨共模输入电压
- 内部迟滞
- 推挽输出 (TLV703x)
- 开漏输出 (TLV704x)
- 过驱动输入无相位反转
- -40°C 至 125°C 工作温度

2 应用

- 手机和平板电脑
- 耳麦/耳机和耳塞
- PC 和笔记本电脑
- 气体检测仪
- 烟雾和热量探测器
- 运动检测器
- 燃气表
- 伺服驱动器位置传感器

3 说明

TLV7031/TLV7041 (单通道)、TLV7032/42 (双通道) 和 TLV7034/44 (四通道) 是低电压、毫微功耗的比较器。这些器件采用超小型无引线封装以及标准的 5 引脚 SC70、SOT-23、VSSOP 和 TSSOP 封装，因此适用于空间受限型设计，例如智能手机、智能仪表和其他便携式或电池供电类应用。

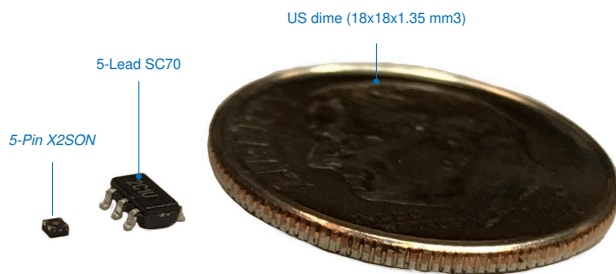

X2SON 封装与 SC70 和美元硬币对比

TLV703x 和 TLV704x 提供出色的速度与功耗综合性能，其传播延迟为 3 μ s，静态电源电流为 315nA。得益于毫微功耗下的快速响应优势，功耗敏感型系统能够监测故障状况并快速做出响应。这些比较器的工作电压范围为 1.6V 至 6.5V，因此可与 3V 和 5V 系统兼容。

TLV703x 和 TLV704x 还凭借过驱输入和内部迟滞特性来确保不会出现输出相位反转，因此工程师可以将此系列的比较器用在必须将慢速输入信号转换为纯净数字输出的严苛、嘈杂环境中进行精密电压监测。

TLV703x 具有推挽式输出级，能够灌/拉毫安级电流，同时可对 LED 进行控制或驱动容性负载。TLV704x 具有可上拉到 V_{CC} 之上的漏极开路输出级，因此适用于电平转换器和双极至单端转换器。

器件信息

| 器件型号 | 封装 (引脚) ⁽¹⁾ | 封装尺寸 (标称值) |
|---------------------|------------------------|-----------------|
| TLV7031、 TLV7041 | X2SON (5) | 0.80mm × 0.80mm |
| | SC70 (5) | 2.00mm × 1.25mm |
| | SOT-23 (5) | 2.90mm × 1.60mm |
| TLV7032、 TLV7042 | VSSOP (8) | 3.00mm × 3.00mm |
| | SOT-23 (8) | 2.90mm × 1.60mm |
| | WSON (8) | 2.00mm × 2.00mm |
| TLV7034、 TLV7044 | WQFN (16) | 3.00mm × 3.00mm |
| | TSSOP (14) | 4.40mm × 5.00mm |

(1) 如需了解所有可用封装，请参阅数据表末尾的可订购产品附录。

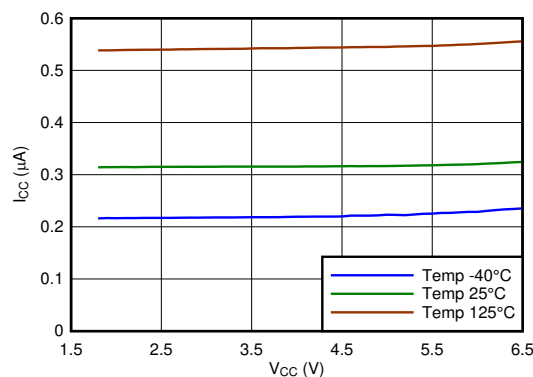

I_{CC} 与电源电压间的关系



Table of Contents

| | | | |
|--|----|--|----|
| 1 特性 | 1 | 7 Detailed Description | 18 |
| 2 应用 | 1 | 7.1 Overview..... | 18 |
| 3 说明 | 1 | 7.2 Functional Block Diagram..... | 18 |
| 4 Revision History | 2 | 7.3 Feature Description..... | 18 |
| 5 Pin Configuration and Functions | 4 | 7.4 Device Functional Modes..... | 18 |
| Pin Functions..... | 4 | 8 Application and Implementation | 20 |
| Pin Functions: TLV7032/42..... | 5 | 8.1 Application Information..... | 20 |
| Pin Functions: TLV7034/44..... | 6 | 8.2 Typical Applications..... | 23 |
| 6 Specifications | 7 | 9 Power Supply Recommendations | 30 |
| 6.1 Absolute Maximum Ratings..... | 7 | 10 Layout | 31 |
| 6.2 ESD Ratings..... | 7 | 10.1 Layout Guidelines..... | 31 |
| 6.3 Recommended Operating Conditions..... | 7 | 10.2 Layout Example..... | 31 |
| 6.4 Thermal Information (Single)..... | 7 | 11 Device and Documentation Support | 32 |
| 6.5 Thermal Information (Dual)..... | 8 | 11.1 Device Support..... | 32 |
| 6.6 Thermal Information (Quad)..... | 8 | 11.2 Documentation Support..... | 32 |
| 6.7 Electrical Characteristics (Single)..... | 9 | 11.3 Receiving Notification of Documentation Updates.. | 32 |
| 6.8 Switching Characteristics (Single)..... | 9 | 11.4 支持资源..... | 32 |
| 6.9 Electrical Characteristics (Dual)..... | 10 | 11.5 Trademarks..... | 32 |
| 6.10 Switching Characteristics (Dual)..... | 10 | 11.6 Electrostatic Discharge Caution..... | 32 |
| 6.11 Electrical Characteristics (Quad)..... | 11 | 11.7 术语表..... | 32 |
| 6.12 Switching Characteristics (Quad)..... | 11 | 12 Mechanical, Packaging, and Orderable Information | 32 |
| 6.13 Timing Diagrams..... | 12 | | |
| 6.14 Typical Characteristics..... | 13 | | |

4 Revision History

注：以前版本的页码可能与当前版本的页码不同

| | |
|--|-------------|
| Changes from Revision G (Nov 2020) to Revision H (July 2021) | Page |
| • 发布了 TSSOP 封装选项..... | 1 |
| Changes from Revision F (November 2019) to Revision G (December 2020) | Page |
| • 更新了整个文档中的表格、图和交叉参考的编号格式..... | 1 |
| • 为双通道选项添加了 SOT-23 (8) 和 WSON (8)..... | 1 |
| Changes from Revision E (June 2019) to Revision F (November 2019) | Page |
| • 添加了四通道版本..... | 1 |
| • 为双通道选项添加了 SOT-23 (8) 和 WSON (8)..... | 1 |
| • 添加了 QUAD 封装选项..... | 1 |
| • Added TSSOP and RTE pinout information to <i>Pin Configuration and Functions</i> section | 5 |
| Changes from Revision D (April 2019) to Revision E (June 2019) | Page |
| • Changed VOH min from 4.7V to 4.65V for all package options in EC Table (Single) | 9 |
| • Changed VOL max from 300mV to 350mV for all package options in EC Table (Single) | 9 |
| • Deleted separate rows for VOH & VOL for DBV package options only in EC Table (Single) | 9 |
| Changes from Revision C (March 2019) to Revision D (April 2019) | Page |
| • Added separate rows for VOH & VOL for DBV package options in EC Table (Single) | 9 |
| Changes from Revision B (May 2018) to Revision C (March 2019) | Page |
| • 在 VSSOP 封装中添加了双通道版本..... | 1 |

| | |
|---|---|
| • 通篇将 TLV7031 更改为 TLV703x 并将 TLV7041 更改为 TLV704x..... | 1 |
| • 添加了双通道版本..... | 1 |
| • 在 VSSOP 封装中添加了器件信息双通道版本..... | 1 |
| • 删除了“SOT-23 封装仅处于预发布状态”..... | 1 |

| | |
|--|-------------|
| Changes from Revision A (January 2018) to Revision B (May 2018) | Page |
|--|-------------|

| | |
|----------------------------|---|
| • 将预发布 SC70 封装更改为量产数据..... | 1 |
|----------------------------|---|

| | |
|--|-------------|
| Changes from Revision * (September 2017) to Revision A (January 2018) | Page |
|--|-------------|

| | |
|--|----|
| • 将数据表标题从“TLV7031/TLV7041 小尺寸、毫微功耗、低电压比较器”更改为“TLV7031 和 TLV7041 小尺寸、毫微功耗、低电压比较器”..... | 1 |
| • 向 <i>特性</i> 中添加了“内部磁滞”项目符号..... | 1 |
| • 在 <i>特性</i> 中注明了哪个器件具有推挽输出和开漏输出选项..... | 1 |
| • 从重要图形标题中删除了 (TLV7031)，因为该图形涵盖了 TLV7031 和 TLV7041 器件..... | 1 |
| • Added X2SON tablenote to <i>Pin Functions</i> table | 4 |
| • Changed 图 6-2 | 12 |
| • Added note to the <i>Timing Diagrams</i> section..... | 12 |
| • Smoothed Propagation Delay plots in 图 6-31 through | 13 |
| • Changed vertical labels on 图 6-20, 图 6-21, 图 6-17, and 图 6-30 | 13 |
| • Changed <i>Functional Block Diagram</i> | 18 |
| • Changed text 'the TLV7041 features an open-drain output stage enabling the output logic levels to be pulled up to an external source up to 7 V' to 'the TLV7041 features an open-drain output stage enabling the output logic levels to be pulled up to an external source up to 6.5 V'..... | 19 |
| • Changed 图 8-3 | 23 |
| • Added note to the <i>Layout Example</i> section..... | 31 |
| • Added <i>Documentation Support</i> section | 32 |

5 Pin Configuration and Functions

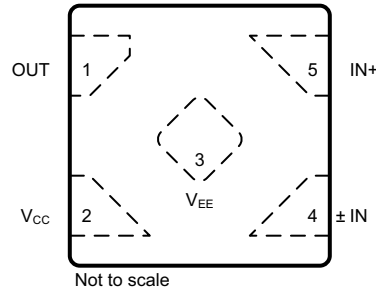

**图 5-1. DPW Package
5-Pin X2SON
Top View**

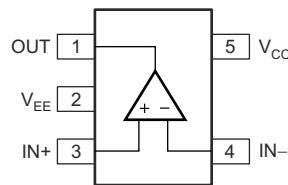

**图 5-2. DBV and DCK Package
5-Pin SOT-23 and SC70
Top View**

Pin Functions

| PIN | | | I/O ⁽²⁾ | DESCRIPTION |
|----------------------|--------------|-----------------|--------------------|---------------------------------|
| X2SON ⁽¹⁾ | SOT-23, SC70 | NAME | | |
| 1 | 1 | OUT | O | Output |
| 2 | 5 | V _{CC} | P | Positive (highest) power supply |
| 3 | 2 | V _{EE} | P | Negative (lowest) power supply |
| 4 | 4 | IN - | I | Inverting input |
| 5 | 3 | IN+ | I | Noninverting input |

- (1) The application report [Designing and Manufacturing With TI's X2SON Packages](#) (SCEA055) provides more details on the optimal PCB designs.
- (2) I = Input, O = Output, P = Power



图 5-3. TLV7032/42 DGK, DDF Packages
8-Pin VSSOP, SOT-23
Top View



A. Connect thermal pad to V - .

图 5-4. TLV7032/42 DSG Package
8-Pin WSON With Exposed Thermal Pad
Top View

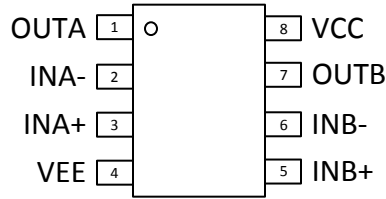
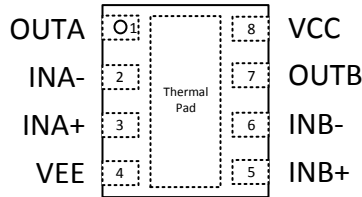
Pin Functions: TLV7032/42

| PIN | | I/O | DESCRIPTION |
|-------|-----|-----|--|
| NAME | NO. | | |
| INA - | 2 | I | Inverting input, channel A |
| INA+ | 3 | I | Noninverting input, channel A |
| INB - | 6 | I | Inverting input, channel B |
| INB+ | 5 | I | Noninverting input, channel B |
| OUTA | 1 | O | Output, channel A |
| OUTB | 7 | O | Output, channel B |
| VEE | 4 | — | Negative (lowest) supply or ground (for single-supply operation) |
| VCC | 8 | — | Positive (highest) supply |



图 5-5. TLV7034/44 PW Packages
14-Pin TSSOP
Top View



A. Connect thermal pad to V - .

图 5-6. TLV7034/44 RTE Package
16-Pin WQFN With Exposed Thermal Pad
Top View

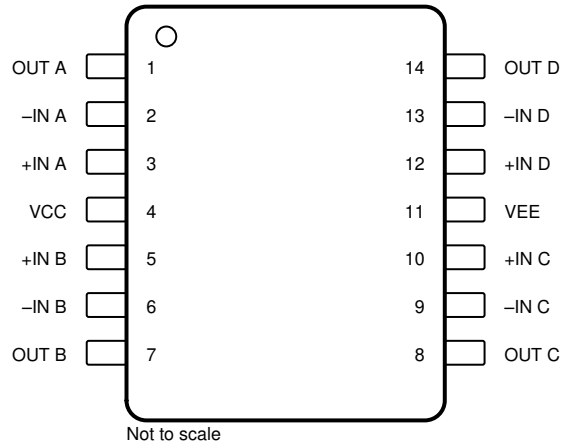
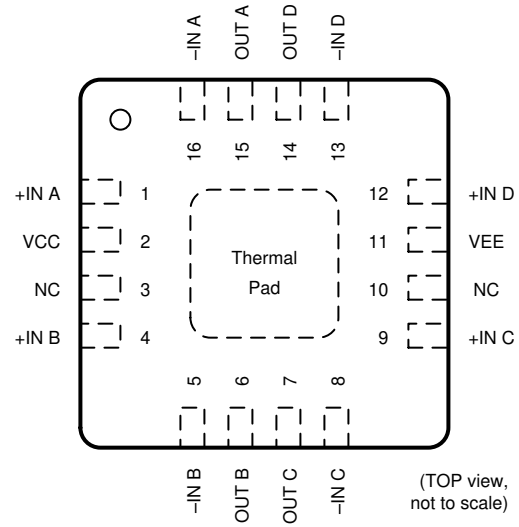
Pin Functions: TLV7034/44

| NAME | PIN | | I/O | DESCRIPTION |
|--------|-------|-------|-----|--|
| | TSSOP | WQFN | | |
| -IN1 A | 2 | 16 | I | Inverting input, channel A |
| +IN A | 3 | 1 | I | Noninverting input, channel A |
| -IN B | 6 | 5 | I | Inverting input, channel B |
| +IN B | 5 | 4 | I | Noninverting input, channel B |
| -IN C | 9 | 8 | I | Inverting input, channel C |
| +IN C | 10 | 9 | I | Noninverting input, channel C |
| -IN D | 13 | 13 | I | Inverting input, channel D |
| +IN D | 12 | 12 | I | Noninverting input, channel D |
| NC | — | 3, 10 | — | No internal connection |
| OUT A | 1 | 15 | O | Output, channel A |
| OUT B | 7 | 6 | O | Output, channel B |
| OUT C | 8 | 7 | O | Output, channel C |
| OUT D | 14 | 14 | O | Output, channel D |
| VEE | 11 | 11 | — | Negative (lowest) supply or ground (for single-supply operation) |
| VCC | 4 | 2 | — | Positive (highest) supply |

6 Specifications

6.1 Absolute Maximum Ratings

over operating free-air temperature range (unless otherwise noted)⁽¹⁾

| | MIN | MAX | UNIT |
|--|----------------|----------------|------|
| Supply voltage $V_S = V_{CC} - V_{EE}$ | - 0.3 | 7 | V |
| Input pins (IN+, IN-) ⁽²⁾ | $V_{EE} - 0.3$ | 7 | V |
| Current into Input pins (IN+, IN-) | | ±10 | mA |
| Output (OUT) (TLV703x) ⁽³⁾ | $V_{EE} - 0.3$ | $V_{CC} + 0.3$ | V |
| Output (OUT) (TLV704x) | $V_{EE} - 0.3$ | 7 | V |
| Output short-circuit duration ⁽⁴⁾ | | 10 | s |
| Junction temperature, T_J | | 150 | °C |
| Storage temperature, T_{stg} | - 65 | 150 | °C |

- (1) Stresses beyond those listed under *Absolute Maximum Ratings* may cause permanent damage to the device. These are stress ratings only, which do not imply functional operation of the device at these or any other conditions beyond those indicated under *Recommended Operating Conditions*. Exposure to absolute-maximum-rated conditions for extended periods may affect device reliability.
- (2) Input terminals are diode-clamped to V_{EE} . Input signals that can swing 0.3V below V_{EE} must be current-limited to 10mA or less.
- (3) Output maximum is ($V_{CC} + 0.3$ V) or 7 V, whichever is less.
- (4) Short-circuit to ground, one comparator per package.

6.2 ESD Ratings

| | | VALUE | UNIT |
|-------------|-------------------------|--|-------|
| $V_{(ESD)}$ | Electrostatic discharge | Human-body model (HBM), per ANSI/ESDA/JEDEC JS-001 ⁽¹⁾ | ±2000 |
| | | Charged-device model (CDM), per JEDEC specification JESD22-C101 ⁽²⁾ | ±1000 |

- (1) JEDEC document JEP155 states that 500-V HBM allows safe manufacturing with a standard ESD control process.
- (2) JEDEC document JEP157 states that 250-V CDM allows safe manufacturing with a standard ESD control process.

6.3 Recommended Operating Conditions

over operating free-air temperature range (unless otherwise noted)

| | MIN | MAX | UNIT |
|--|----------------|----------------|------|
| Supply voltage $V_S = V_{CC} - V_{EE}$ | 1.6 | 6.5 | V |
| Input voltage range | $V_{EE} - 0.1$ | $V_{CC} + 0.1$ | V |
| Ambient temperature, T_A | - 40 | 125 | °C |

6.4 Thermal Information (Single)

| THERMAL METRIC ⁽¹⁾ | | TLV7031/TLV7041 | | | UNIT |
|-------------------------------|--|-----------------|--------------|------------|------|
| | | DPW (X2SON) | DBV (SOT-23) | DCK (SC70) | |
| | | 5 PINS | 5 PINS | 5 PINS | |
| $R_{\theta JA}$ | Junction-to-ambient thermal resistance | 533.2 | 297.2 | 278.8 | °C/W |
| $R_{\theta JC(top)}$ | Junction-to-case (top) thermal resistance | 302.7 | 224.7 | 186.6 | °C/W |
| $R_{\theta JB}$ | Junction-to-board thermal resistance | 408.3 | 200.1 | 113.2 | °C/W |
| Ψ_{JT} | Junction-to-top characterization parameter | 71.5 | 141.2 | 82.3 | °C/W |
| Ψ_{JB} | Junction-to-board characterization parameter | 405.9 | 198.9 | 112.4 | °C/W |
| $R_{\theta JC(bot)}$ | Junction-to-case (bottom) thermal resistance | 188.3 | N/A | N/A | °C/W |

- (1) For more information about traditional and new thermal metrics, see the [Semiconductor and IC Package Thermal Metrics](#) application report.

6.5 Thermal Information (Dual)

| THERMAL METRIC ⁽¹⁾ | | TLV7032/TLV7042 | | | UNIT |
|-------------------------------|--|-----------------|--------------|------------|------|
| | | DGK (VSSOP) | DDF (SOT-23) | DSG (WSON) | |
| | | 8 PINS | 8 PINS | 8 PINS | |
| $R_{\theta JA}$ | Junction-to-ambient thermal resistance | 211.7 | 212.5 | 106.1 | °C/W |
| $R_{\theta JC(top)}$ | Junction-to-case (top) thermal resistance | 96.1 | 127.3 | 127.3 | °C/W |
| $R_{\theta JB}$ | Junction-to-board thermal resistance | 133.5 | 129.2 | 72.5 | °C/W |
| Ψ_{JT} | Junction-to-top characterization parameter | 28.3 | 25.8 | 16.8 | °C/W |
| Ψ_{JB} | Junction-to-board characterization parameter | 131.7 | 129.0 | 72.2 | °C/W |
| $R_{\theta JC(bot)}$ | Junction-to-case (bottom) thermal resistance | N/A | N/A | 47.6 | °C/W |

(1) For more information about traditional and new thermal metrics, see the [Semiconductor and IC Package Thermal Metrics](#) application report.

6.6 Thermal Information (Quad)

| THERMAL METRIC ⁽¹⁾ | | TLV7034/44 | | UNIT |
|-------------------------------|--|------------|------------|------|
| | | RTE (QFN) | PW (TSSOP) | |
| | | 16 PINS | 14 PINS | |
| $R_{\theta JA}$ | Junction-to-ambient thermal resistance | 65.4 | 131.0 | °C/W |
| $R_{\theta JC(top)}$ | Junction-to-case (top) thermal resistance | 70.2 | 60.5 | °C/W |
| $R_{\theta JB}$ | Junction-to-board thermal resistance | 40.5 | 74.1 | °C/W |
| Ψ_{JT} | Junction-to-top characterization parameter | 5.6 | 12.6 | °C/W |
| Ψ_{JB} | Junction-to-board characterization parameter | 40.5 | 73.5 | °C/W |
| $R_{\theta JC(bot)}$ | Junction-to-case (bottom) thermal resistance | 24.1 | n/a | °C/W |

6.7 Electrical Characteristics (Single)

$V_S = 1.8\text{ V to }5\text{ V}$, $V_{CM} = V_S / 2$; minimum and maximum values are at $T_A = -40^\circ\text{C to }+125^\circ\text{C}$ (unless otherwise noted). Typical values are at $T_A = 25^\circ\text{C}$.

| PARAMETER | | TEST CONDITIONS | MIN | TYP | MAX | UNIT |
|-----------|--|---|----------|-----------|----------------|------|
| V_{IO} | Input Offset Voltage | $V_S = 1.8\text{ V and }5\text{ V}$, $V_{CM} = V_S / 2$ | | ± 0.1 | ± 8 | mV |
| V_{HYS} | Hysteresis | $V_S = 1.8\text{ V and }5\text{ V}$, $V_{CM} = V_S / 2$, $T_A = 25^\circ\text{C}$ | 2 | 7 | 17 | mV |
| V_{CM} | Common-mode voltage range | | V_{EE} | | $V_{CC} + 0.1$ | V |
| I_B | Input bias current | | | 2 | | pA |
| I_{OS} | Input offset current | | | 1 | | pA |
| V_{OH} | Output voltage high (for TLV7031 only) | $V_S = 5\text{ V}$, $V_{EE} = 0\text{ V}$, $I_O = 3\text{ mA}$ | 4.65 | 4.8 | | V |
| V_{OL} | Output voltage low | $V_S = 5\text{ V}$, $V_{EE} = 0\text{ V}$, $I_O = 3\text{ mA}$ | | 250 | 350 | mV |
| I_{LKG} | Open-drain output leakage current (TLV7041 only) | $V_S = 5\text{ V}$, $V_{ID} = +0.1\text{ V}$ (output high), $V_{PULLUP} = V_{CC}$ | | 100 | | pA |
| CMRR | Common-mode rejection ratio | $V_{EE} < V_{CM} < V_{CC}$, $V_S = 5\text{ V}$ | | 73 | | dB |
| PSRR | Power supply rejection ratio | $V_S = 1.8\text{ V to }5\text{ V}$, $V_{CM} = V_S / 2$ | | 77 | | dB |
| I_{SC} | Short-circuit current | $V_S = 5\text{ V}$, sourcing | | 29 | | mA |
| | | $V_S = 5\text{ V}$, sinking | | 33 | | |
| I_{CC} | Supply current | $V_S = 1.8\text{ V}$, no load, $V_{ID} = -0.1\text{ V}$ (Output Low) | | 335 | 900 | nA |

6.8 Switching Characteristics (Single)

Typical values are at $T_A = 25^\circ\text{C}$, $V_S = 5\text{ V}$, $V_{CM} = V_S / 2$; $CL = 15\text{ pF}$, input overdrive = 100 mV (unless otherwise noted).

| PARAMETER | | TEST CONDITIONS | MIN | TYP | MAX | UNIT |
|-----------|--|--|-----|-----|-----|---------------|
| t_{PHL} | Propagation delay time, high to-low (RP = 2.5 k Ω TLV7041 only) | Midpoint of input to midpoint of output, $V_{OD} = 100\text{ mV}$ | | 3 | | μs |
| t_{PLH} | Propagation delay time, low-to high (RP = 2.5 k Ω TLV7041 only) | Midpoint of input to midpoint of output, $V_{OD} = 100\text{ mV}$ | | 3 | | μs |
| t_R | Rise time (TLV7031 only) | Measured from 10% to 90% | | 4.5 | | ns |
| t_F | Fall time | Measured from 10% to 90% | | 4.5 | | ns |
| t_{ON} | Power-up time | During power on, V_{CC} must exceed 1.6V for 200 μs before the output will reflect the input. | | 200 | | μs |

6.9 Electrical Characteristics (Dual)

$V_S = 1.8\text{ V to }5\text{ V}$, $V_{CM} = V_S / 2$; minimum and maximum values are at $T_A = -40^\circ\text{C to }+125^\circ\text{C}$ (unless otherwise noted). Typical values are at $T_A = 25^\circ\text{C}$.

| PARAMETER | | TEST CONDITIONS | MIN | TYP | MAX | UNIT |
|-----------|--|--|----------|-----------|----------------|------|
| V_{IO} | Input Offset Voltage | $V_S = 1.8\text{ V and }5\text{ V}$, $V_{CM} = V_S / 2$ | | ± 0.1 | ± 8 | mV |
| V_{HYS} | Hysteresis | $V_S = 1.8\text{ V and }5\text{ V}$, $V_{CM} = V_S / 2$ | 3 | 10 | 25 | mV |
| V_{CM} | Common-mode voltage range | | V_{EE} | | $V_{CC} + 0.1$ | V |
| I_B | Input bias current | | | 2 | | pA |
| I_{OS} | Input offset current | | | 1 | | pA |
| V_{OH} | Output voltage high (for TLV7032 only) | $V_S = 5\text{ V}$, $V_{EE} = 0\text{ V}$, $I_O = 3\text{ mA}$ | 4.65 | 4.8 | | V |
| V_{OL} | Output voltage low | $V_S = 5\text{ V}$, $V_{EE} = 0\text{ V}$, $I_O = 3\text{ mA}$ | | 250 | 350 | mV |
| I_{LKG} | Open-drain output leakage current (TLV7042 only) | $V_S = 5\text{ V}$, $V_{ID} = +0.1\text{ V}$ (output high), $V_{PULLUP} = V_{CC}$ | | 100 | | pA |
| CMRR | Common-mode rejection ratio | $V_{EE} < V_{CM} < V_{CC}$, $V_S = 5\text{ V}$ | | 73 | | dB |
| PSRR | Power supply rejection ratio | $V_S = 1.8\text{ V to }5\text{ V}$, $V_{CM} = V_S / 2$ | | 77 | | dB |
| I_{SC} | Short-circuit current | $V_S = 5\text{ V}$, sourcing (for TLV7032 only) | | 29 | | mA |
| | | $V_S = 5\text{ V}$, sinking | | 33 | | |
| I_{CC} | Supply current / Channel | $V_S = 1.8\text{ V}$, no load, $V_{ID} = -0.1\text{ V}$ (Output Low) | | 315 | 750 | nA |

6.10 Switching Characteristics (Dual)

Typical values are at $T_A = 25^\circ\text{C}$, $V_S = 5\text{ V}$, $V_{CM} = V_S / 2$; $CL = 15\text{ pF}$, input overdrive = 100 mV (unless otherwise noted).

| PARAMETER | | TEST CONDITIONS | MIN | TYP | MAX | UNIT |
|-----------|---|---|-----|-----|-----|---------------|
| t_{PHL} | Propagation delay time, high to-low (RP = 4.99 k Ω TLV7042 only) (1) | Midpoint of input to midpoint of output, $V_{OD} = 100\text{ mV}$ | | 3 | | μs |
| t_{PLH} | Propagation delay time, low-to-high (RP = 4.99 k Ω TLV7042 only) (1) | Midpoint of input to midpoint of output, $V_{OD} = 100\text{ mV}$ | | 3 | | μs |
| t_R | Rise time (TLV7032 only) | Measured from 20% to 80% | | 4.5 | | ns |
| t_F | Fall time | Measured from 20% to 80% | | 4.5 | | ns |
| t_{ON} | Power-up time | During power on, V_{CC} must exceed 1.6V for t_{ON} before the output will reflect the input. | | 200 | | μs |

(1) The lower limit for RP is 650 Ω

6.11 Electrical Characteristics (Quad)

$V_S = 1.8\text{ V to }5\text{ V}$, $V_{CM} = V_S / 2$; minimum and maximum values are at $T_A = -40^\circ\text{C to }+125^\circ\text{C}$ (unless otherwise noted). Typical values are at $T_A = 25^\circ\text{C}$.

| PARAMETER | | TEST CONDITIONS | MIN | TYP | MAX | UNIT |
|-----------|--|--|----------|-----------|----------------|------|
| V_{IO} | Input Offset Voltage | $V_S = 1.8\text{ V and }5\text{ V}$, $V_{CM} = V_S / 2$ | | ± 0.1 | ± 8 | mV |
| V_{HYS} | Hysteresis | $V_S = 1.8\text{ V and }5\text{ V}$, $V_{CM} = V_S / 2$ | 3 | 10 | 25 | mV |
| V_{CM} | Common-mode voltage range | | V_{EE} | | $V_{CC} + 0.1$ | V |
| I_B | Input bias current | | | 2 | | pA |
| I_{OS} | Input offset current | | | 1 | | pA |
| V_{OH} | Output voltage high (for TLV7034 only) | $V_S = 5\text{ V}$, $V_{EE} = 0\text{ V}$, $I_O = 3\text{ mA}$ | 4.65 | 4.8 | | V |
| V_{OL} | Output voltage low | $V_S = 5\text{ V}$, $V_{EE} = 0\text{ V}$, $I_O = 3\text{ mA}$ | | 250 | 350 | mV |
| I_{LKG} | Open-drain output leakage current (TLV7044 only) | $V_S = 5\text{ V}$, $V_{ID} = +0.1\text{ V}$ (output high), $V_{PULLUP} = V_{CC}$ | | 100 | | pA |
| CMRR | Common-mode rejection ratio | $V_{EE} < V_{CM} < V_{CC}$, $V_S = 5\text{ V}$ | | 73 | | dB |
| PSRR | Power supply rejection ratio | $V_S = 1.8\text{ V to }5\text{ V}$, $V_{CM} = V_S / 2$ | | 77 | | dB |
| I_{SC} | Short-circuit current | $V_S = 5\text{ V}$, sourcing (for TLV7034 only) | | 29 | | mA |
| | | $V_S = 5\text{ V}$, sinking | | 33 | | |
| I_{CC} | Supply current / Channel | $V_S = 1.8\text{ V}$, no load, $V_{ID} = -0.1\text{ V}$ (Output Low) | | 315 | 750 | nA |

6.12 Switching Characteristics (Quad)

Typical values are at $T_A = 25^\circ\text{C}$, $V_S = 5\text{ V}$, $V_{CM} = V_S / 2$; $CL = 15\text{ pF}$, input overdrive = 100 mV (unless otherwise noted).

| PARAMETER | | TEST CONDITIONS | MIN | TYP | MAX | UNIT |
|-----------|---|--|-----|-----|-----|---------------|
| t_{PHL} | Propagation delay time, high to-low (RP = 4.99 k Ω TLV7044 only) (1) | Midpoint of input to midpoint of output, $V_{OD} = 100\text{ mV}$ | | 3 | | μs |
| t_{PLH} | Propagation delay time, low-to-high (RP = 4.99 k Ω TLV7044 only) (1) | Midpoint of input to midpoint of output, $V_{OD} = 100\text{ mV}$ | | 3 | | μs |
| t_R | Rise time (TLV7034 only) | Measured from 20% to 80% | | 4.5 | | ns |
| t_F | Fall time | Measured from 20% to 80% | | 4.5 | | ns |
| t_{ON} | Power-up time | During power on, V_{CC} must exceed 1.6V for t_{ON} before the output will reflect the input.. | | 400 | | μs |

(1) The lower limit for RP is 650 Ω

6.13 Timing Diagrams



图 6-1. Start-Up Time Timing Diagram (IN+ > IN-)



图 6-2. Propagation Delay Timing Diagram

备注

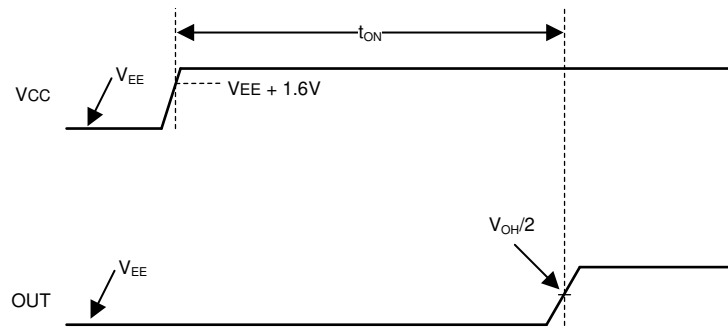
The propagation delays t_{pLH} and t_{pHL} include the contribution of input offset and hysteresis.

6.14 Typical Characteristics

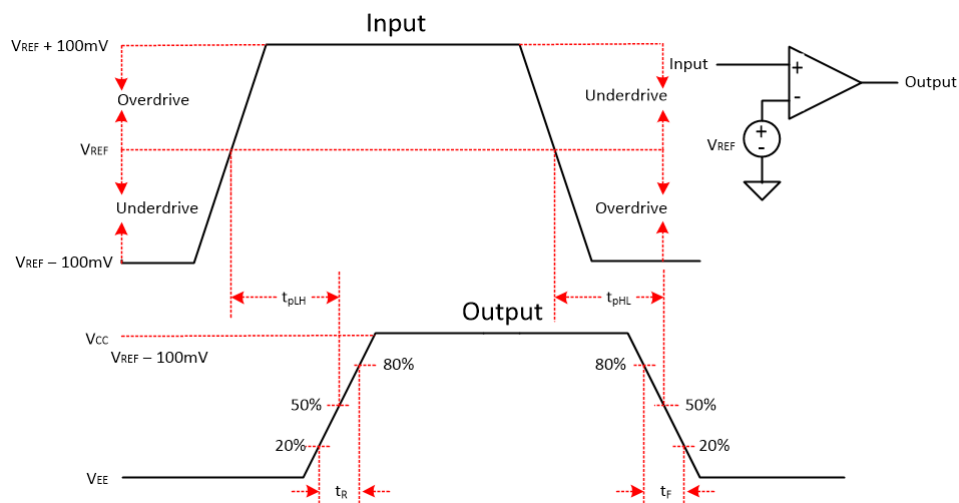
$T_A = 25^\circ\text{C}$, $V_{CC} = 5\text{ V}$, $V_{EE} = 0\text{ V}$, $V_{CM} = V_{CC}/2$, $C_L = 15\text{ pF}$



图 6-3. Input Offset vs Temperature



图 6-4. Input Offset vs Temperature

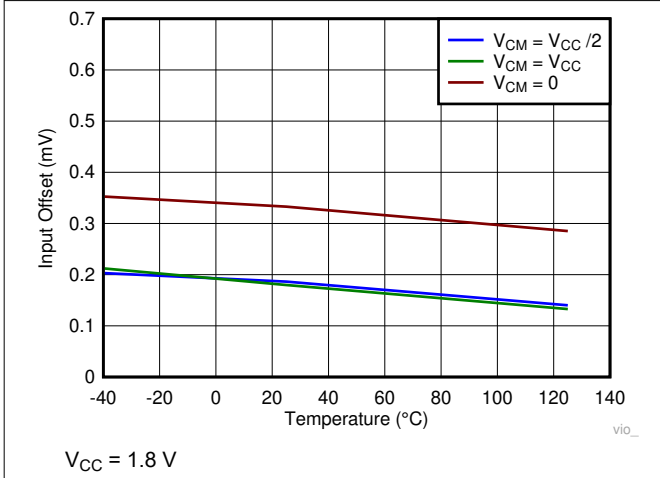

图 6-5. Input Offset vs Temperature

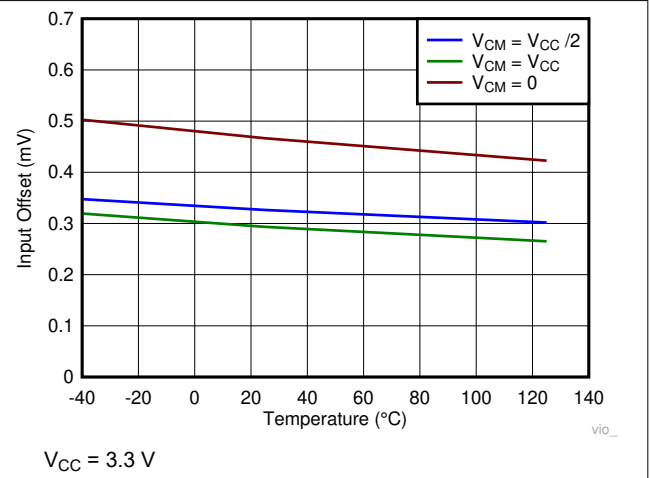

图 6-6. Input Offset Voltage vs V_{CM}

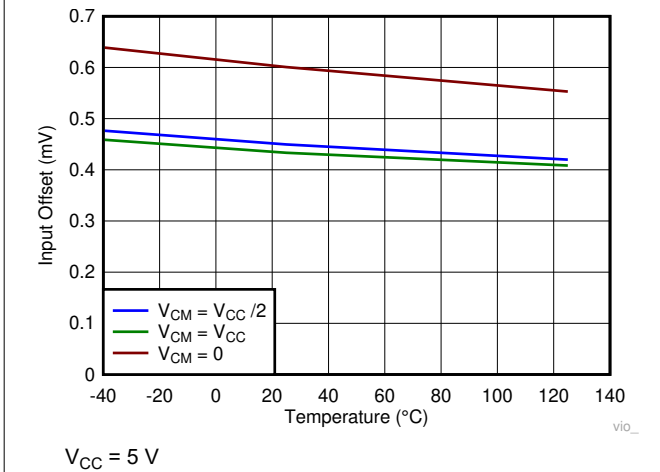

图 6-7. Input Offset Voltage vs V_{CM}

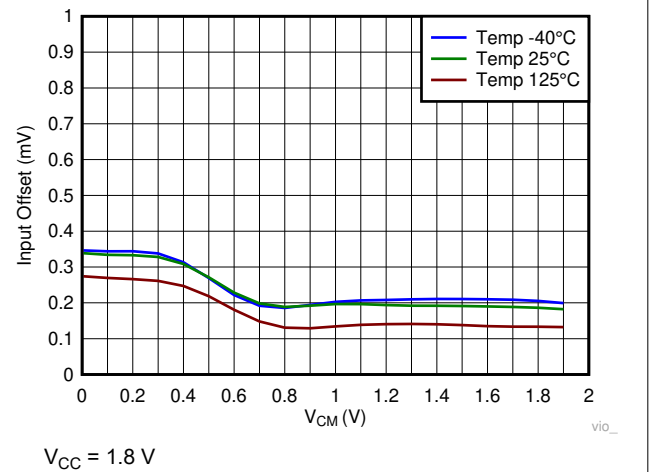

图 6-8. Input Offset Voltage vs V_{CM}

6.14 Typical Characteristics (continued)

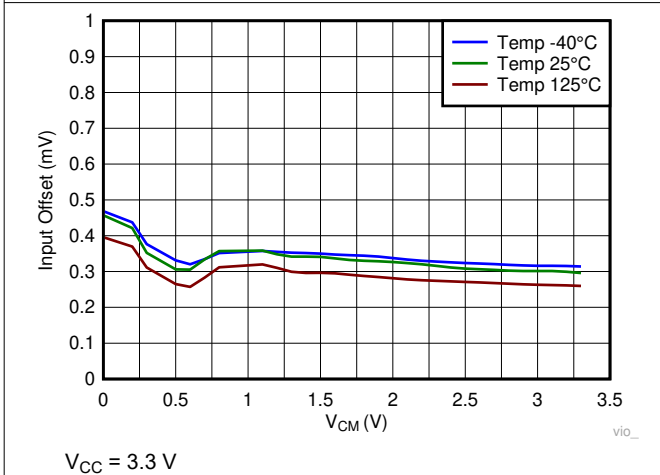
$T_A = 25^\circ\text{C}$, $V_{CC} = 5\text{ V}$, $V_{EE} = 0\text{ V}$, $V_{CM} = V_{CC}/2$, $C_L = 15\text{ pF}$

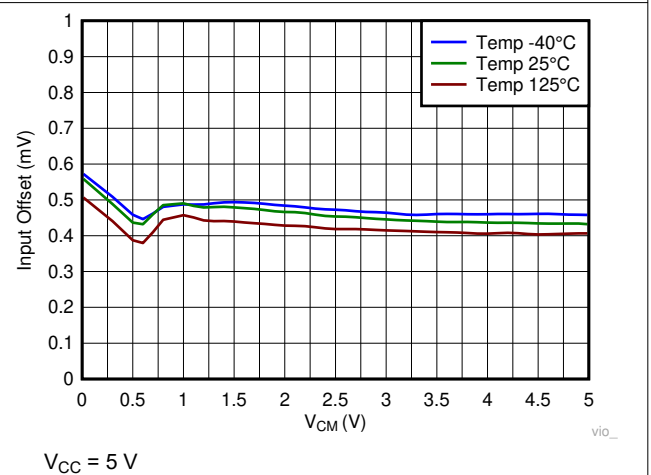
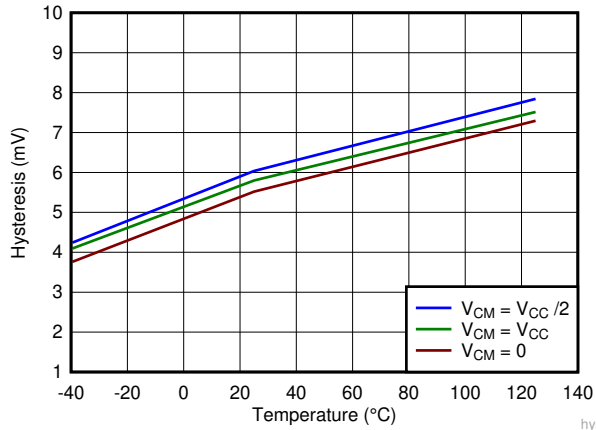

$V_{CC} = 1.8\text{ V to } 5\text{ V}$ TLV70x1

图 6-9. Hysteresis vs Temperature

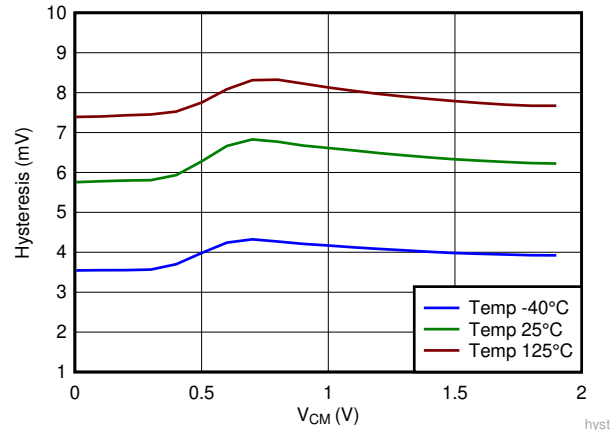

$V_{CC} = 1.8\text{ V}$ TLV70x1

图 6-10. Hysteresis vs V_{CM}

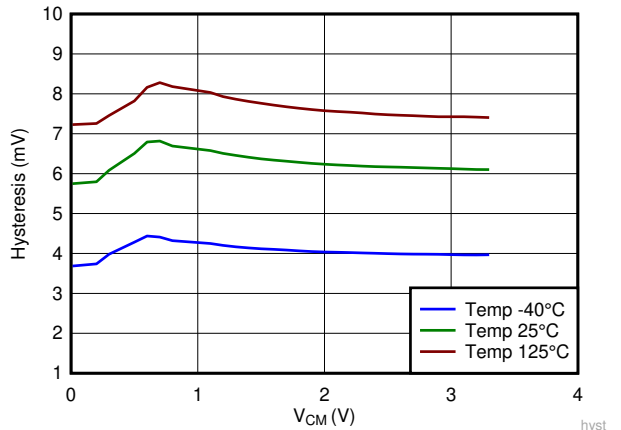

$V_{CC} = 3.3\text{ V}$ TLV70x1

图 6-11. Hysteresis vs V_{CM}

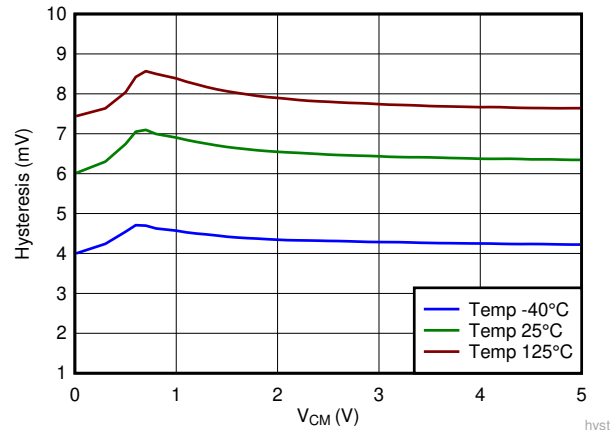

$V_{CC} = 5\text{ V}$ TLV70x1

图 6-12. Hysteresis vs V_{CM}

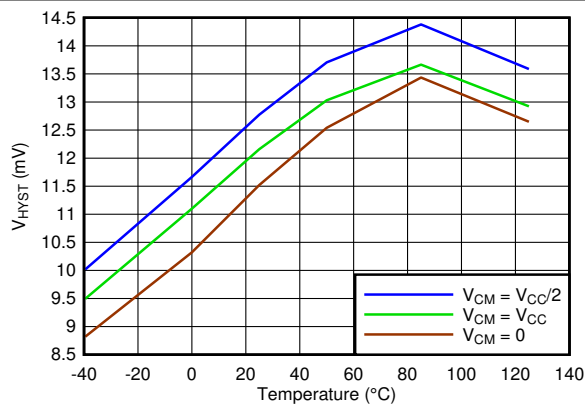

$V_{CC} = 1.8\text{ V to } 5\text{ V}$ TLV70x2

图 6-13. Hysteresis vs Temperature

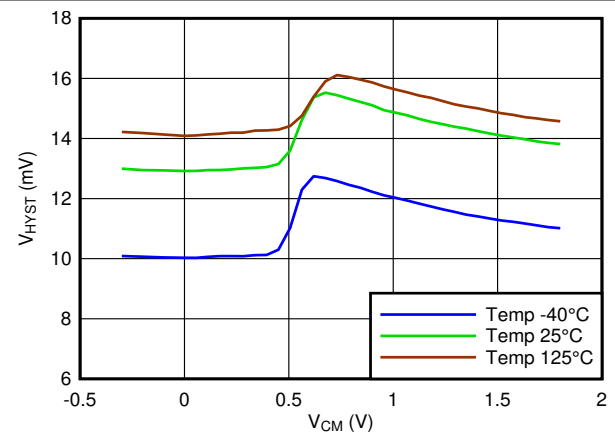

$V_{CC} = 1.8\text{ V}$ TLV70x2

图 6-14. Hysteresis vs V_{CM}

6.14 Typical Characteristics (continued)

$T_A = 25^\circ\text{C}$, $V_{CC} = 5\text{ V}$, $V_{EE} = 0\text{ V}$, $V_{CM} = V_{CC}/2$, $C_L = 15\text{ pF}$



图 6-15. Hysteresis vs V_{CM}



图 6-16. Hysteresis vs V_{CM}

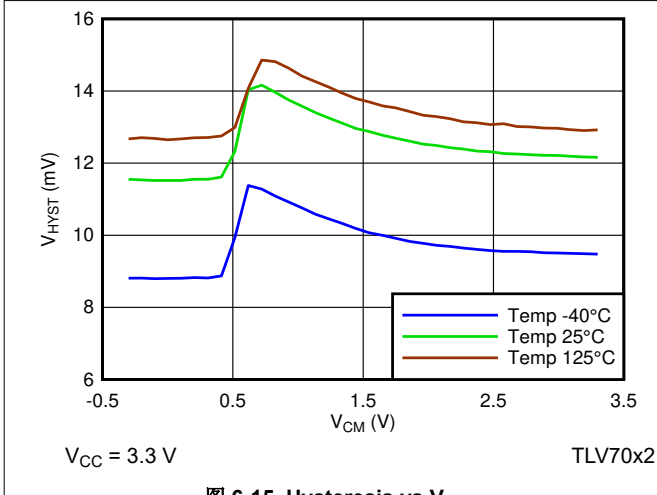

图 6-17. Input Bias Current vs Temperature

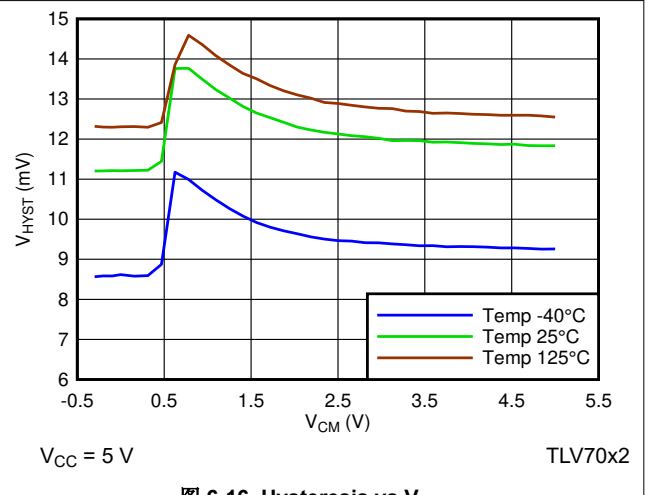

图 6-18. Output Voltage High vs Output Source Current

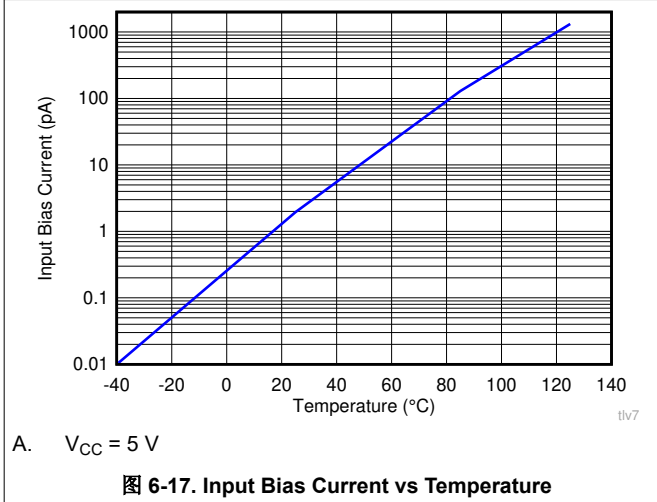

图 6-19. Output Voltage High vs Output Source Current

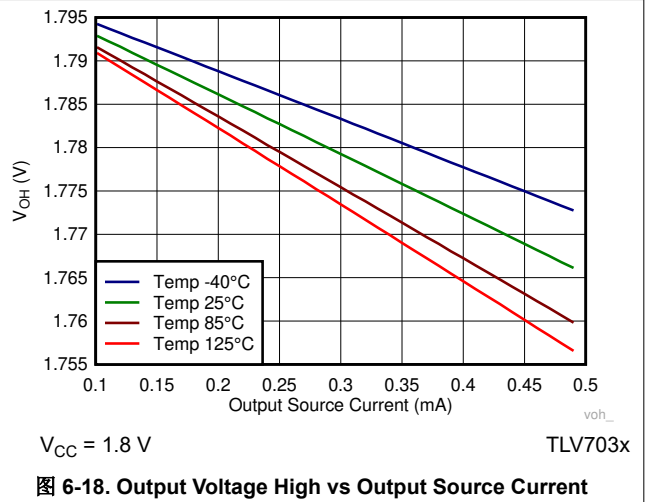

图 6-20. Output Voltage Low vs Output Sink Current

6.14 Typical Characteristics (continued)

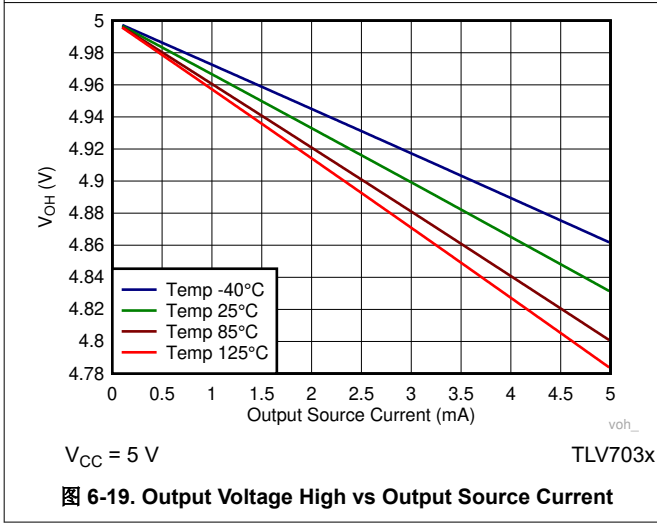
$T_A = 25^\circ\text{C}$, $V_{CC} = 5\text{ V}$, $V_{EE} = 0\text{ V}$, $V_{CM} = V_{CC}/2$, $C_L = 15\text{ pF}$

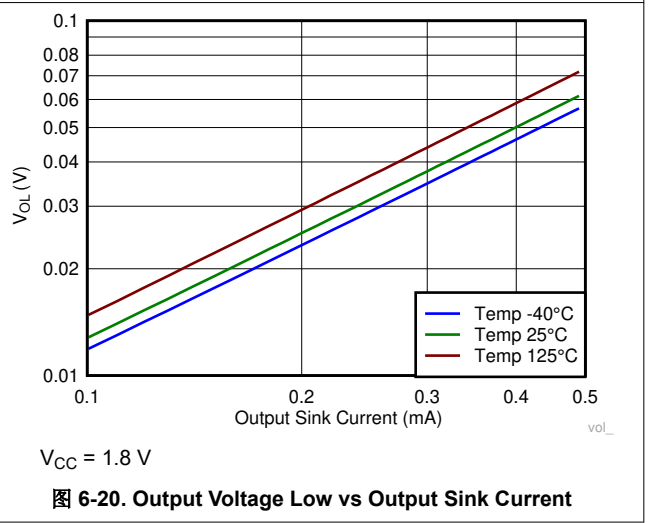

图 6-21. Output Voltage Low vs Output Sink Current



图 6-22. Output Short-Circuit (Sink) Current vs Temperature

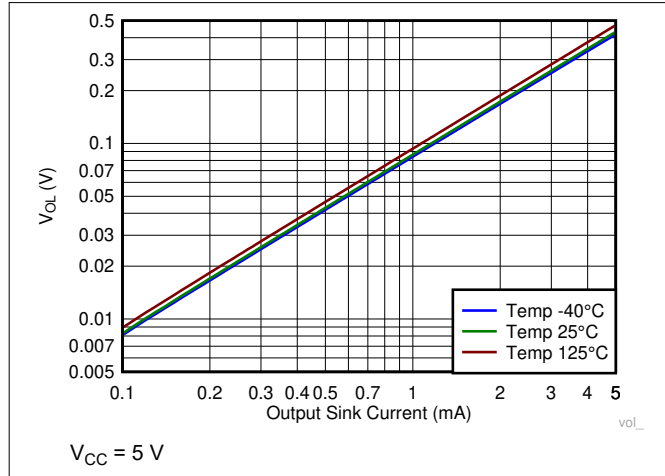

图 6-23. Output Short-Circuit (Source) Current vs Temperature

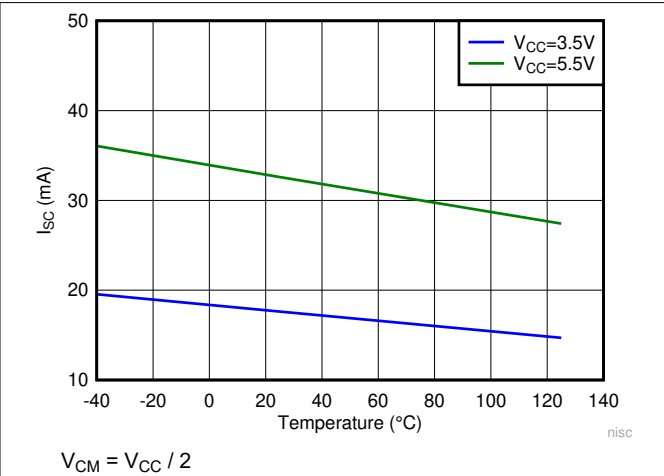

图 6-24. Output Short Circuit (Sink) vs VCC

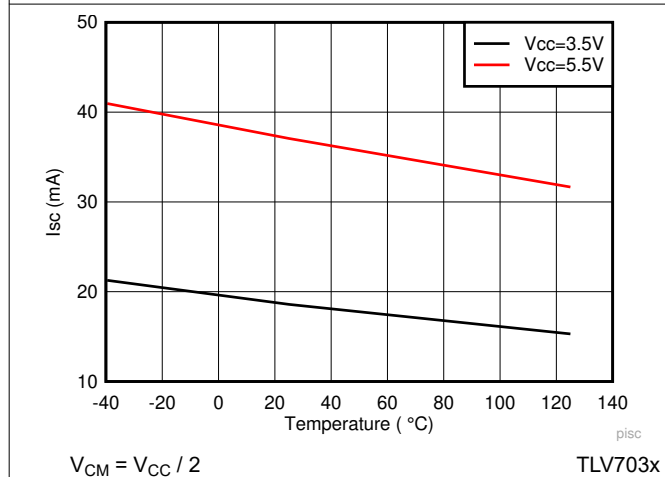

图 6-25. Output Short Circuit (Source) vs VCC

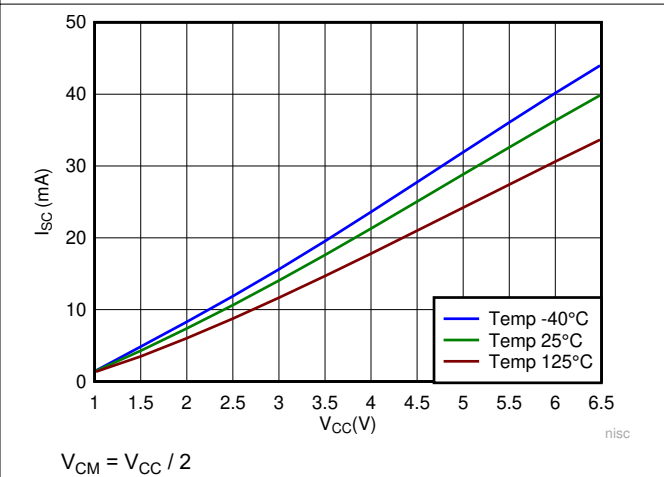

图 6-26. ICC vs Temperature

6.14 Typical Characteristics (continued)

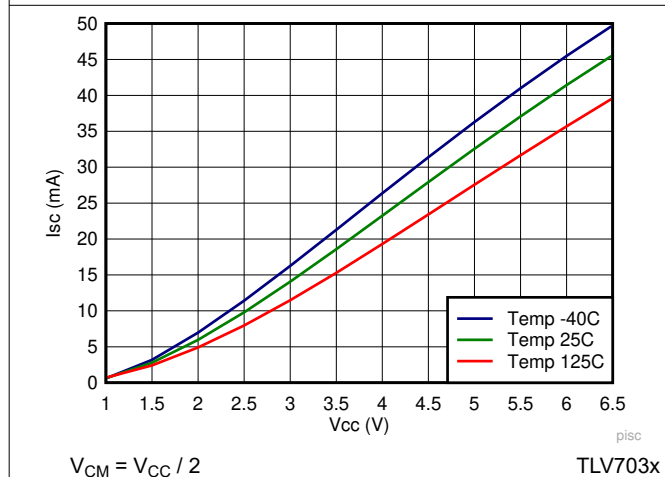
$T_A = 25^\circ\text{C}$, $V_{CC} = 5\text{ V}$, $V_{EE} = 0\text{ V}$, $V_{CM} = V_{CC}/2$, $C_L = 15\text{ pF}$

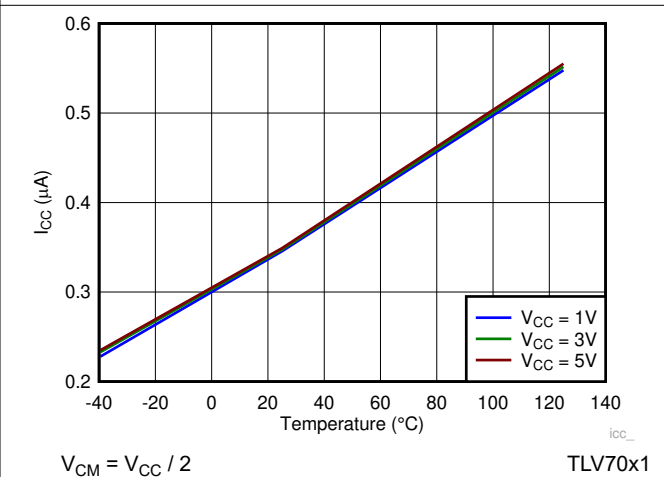

图 6-27. I_{CC} vs V_{CC}



图 6-28. I_{CC} vs Temperature

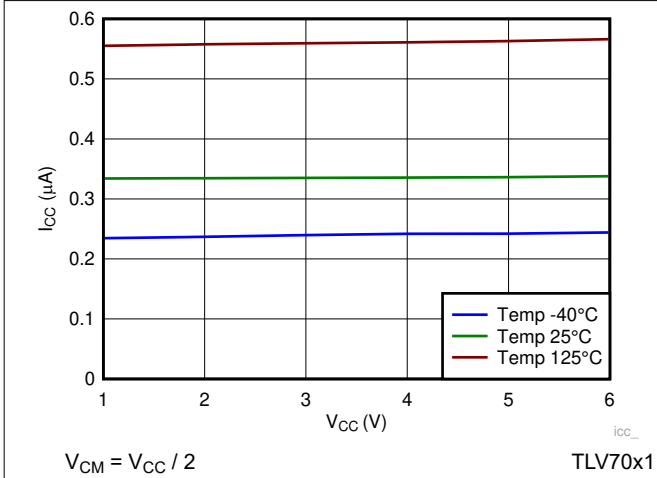

图 6-29. I_{CC} vs V_{CC}

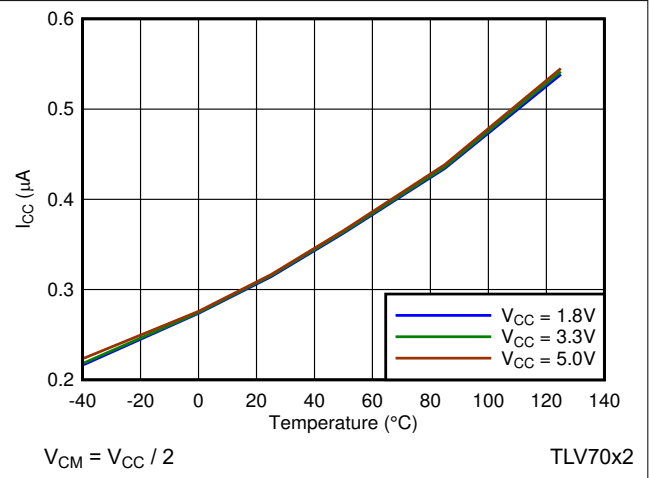

图 6-30. Rise/Fall Time vs Load Capacitance

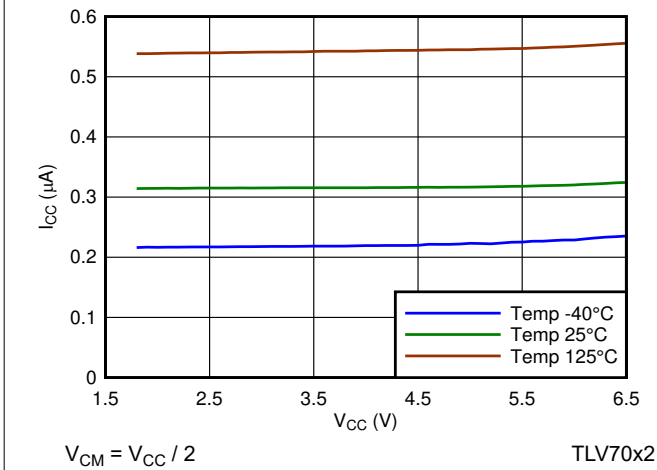

图 6-31. Propagation Delay (L-H) vs Input Overdrive

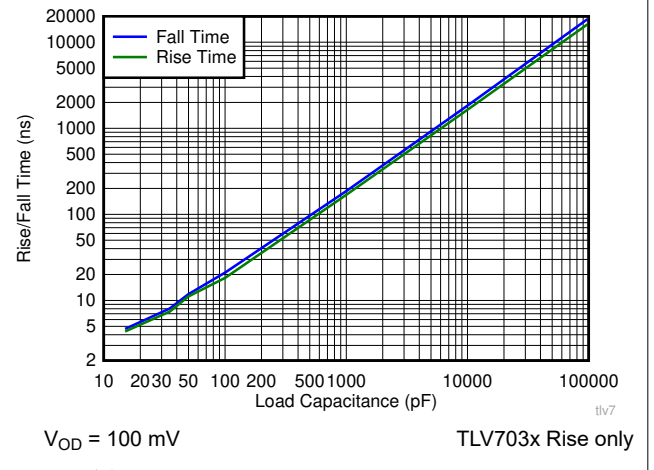

图 6-32. Propagation Delay (H-L) vs Input Overdrive

7 Detailed Description

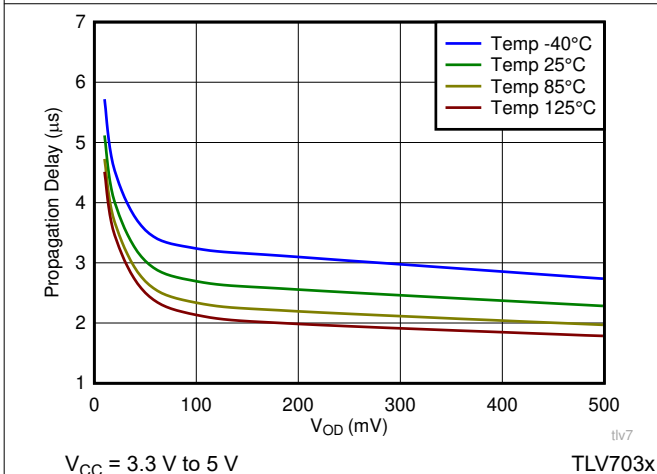
7.1 Overview

The TLV703x and TLV704x are nano-power comparators with push-pull and open-drain outputs. Operating from 1.6 V to 6.5 V and consuming only 315 nA, the TLV703x and TLV704x are designed for portable and industrial applications. The TLV703x and TLV704x are available in a variety of leadless and leaded packages to offer significant board space saving in space-challenged designs.

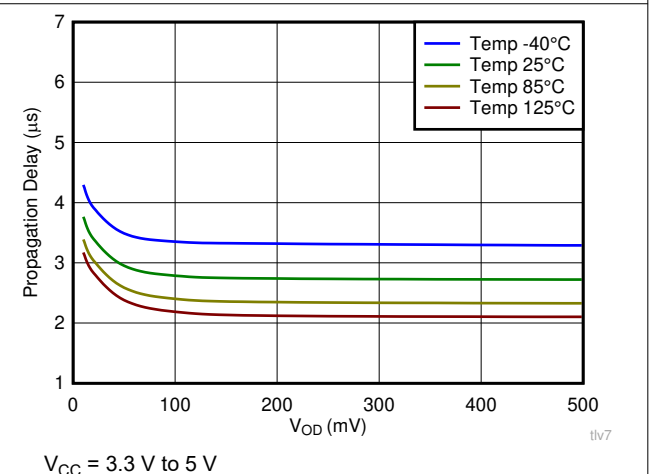
7.2 Functional Block Diagram

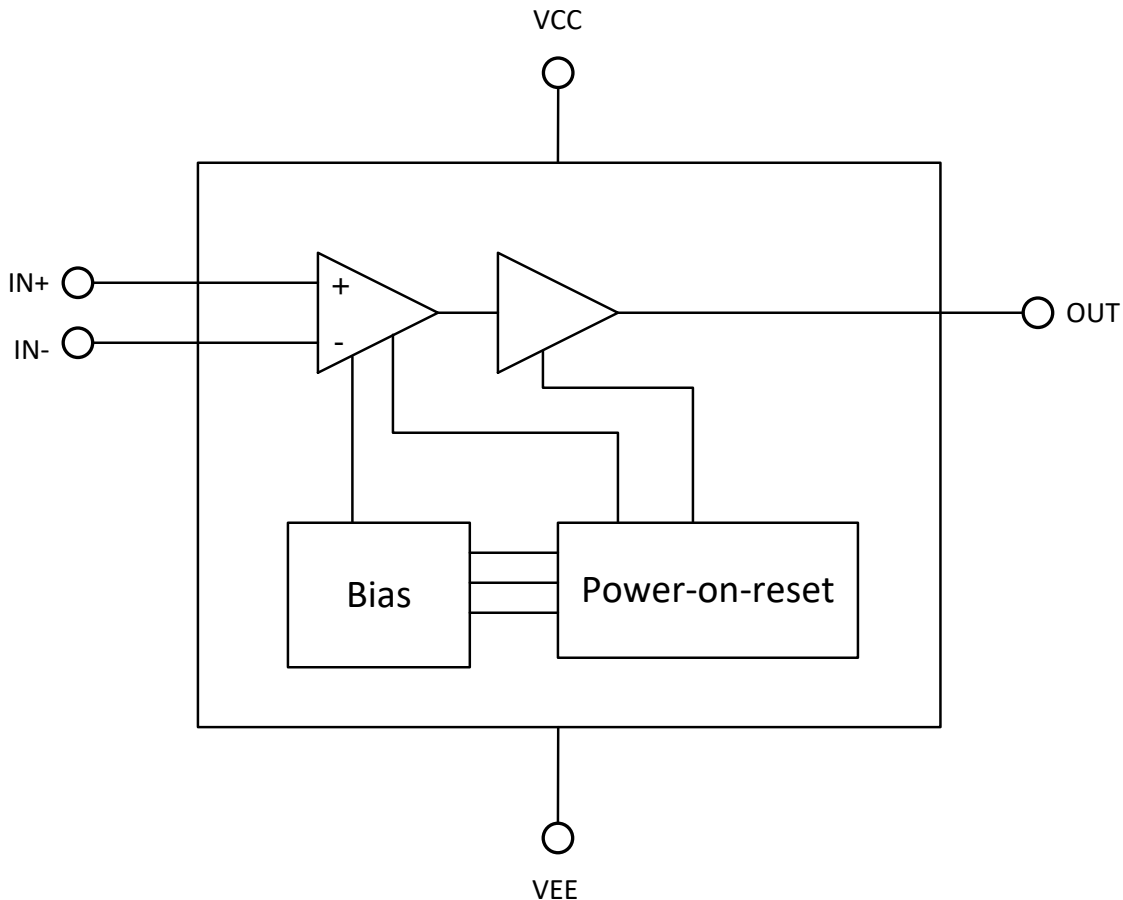

7.3 Feature Description

The TLV703x and TLV704x devices are nanoPower comparators that are capable of operating at low voltages. The TLV703x and TLV704x feature a rail-to-rail input stage capable of operating up to 100 mV beyond the VCC power supply rail. The TLV703x (push-pull) and TLV704x (open-drain) also feature internal hysteresis.

7.4 Device Functional Modes

The TLV703x and TLV704x have a power-on-reset (POR) circuit. While the power supply (V_S) is less than the minimum supply voltage, either upon ramp-up or ramp-down, the POR circuitry is activated.

For the TLV703x, the POR circuit holds the output low (at V_{EE}) while activated.

For the TLV704x, the POR circuit keeps the output high impedance (logical high) while activated.

When the supply voltage is greater than, or equal to, the minimum supply voltage, the comparator output reflects the state of the differential input (V_{ID}).

7.4.1 Inputs

The TLV703x and TLV704x input common-mode extends from V_{EE} to 100 mV above V_{CC} . The differential input voltage (V_{ID}) can be any voltage within these limits. No phase inversion of the comparator output occurs when the input pins exceed V_{CC} and V_{EE} .

The input of TLV703x and TLV704x is fault tolerant. It maintains the same high input impedance when V_{CC} is unpowered or ramping up. The input can be safely driven up to the specified maximum voltage (7 V) with $V_{CC} = 0$ V or any value up to the maximum specified. The V_{CC} is isolated from the input such that it maintains its value even when a higher voltage is applied to the input.

The input bias current is typically 1 pA for input voltages between V_{CC} and V_{EE} . The comparator inputs are protected from voltages below V_{EE} by internal diodes connected to V_{EE} . As the input voltage goes under V_{EE} , the protection diodes become forward biased and begin to conduct causing the input bias current to increase exponentially. Input bias current typically doubles every 10°C temperature increases.

7.4.2 Internal Hysteresis

The device hysteresis transfer curve is shown in 图 7-1. This curve is a function of three components: V_{TH} , V_{OS} , and V_{HYST} :

- V_{TH} is the actual set voltage or threshold trip voltage.
- V_{OS} is the internal offset voltage between V_{IN+} and V_{IN-} . This voltage is added to V_{TH} to form the actual trip point at which the comparator must respond to change output states.
- V_{HYST} is the internal hysteresis (or trip window) that is designed to reduce comparator sensitivity to noise (7 mV for both TLV703x and TLV704x).



图 7-1. Hysteresis Transfer Curve

7.4.3 Output

The TLV703x features a push-pull output stage eliminating the need for an external pullup resistor. On the other hand, the TLV704x features an open-drain output stage enabling the output logic levels to be pulled up to an external source up to 6.5 V independent of the supply voltage.

8 Application and Implementation

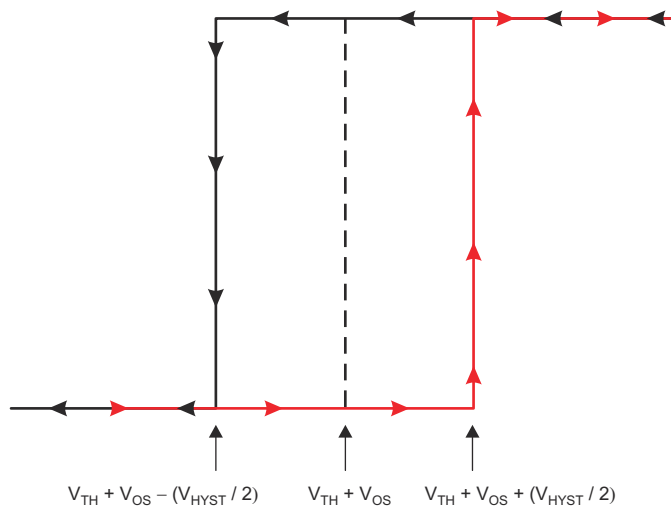
备注

以下应用部分中的信息不属于 TI 器件规格的范围，TI 不担保其准确性和完整性。TI 的客户应负责确定器件是否适用于其应用。客户应验证并测试其设计，以确保系统功能。

8.1 Application Information

The TLV703x and TLV704x are nano-power comparators with reasonable response time. The comparators have a rail-to-rail input stage that can monitor signals beyond the positive supply rail with integrated hysteresis. When higher levels of hysteresis are required, positive feedback can be externally added. The push-pull output stage of the TLV703x is optimal for reduced power budget applications and features no shoot-through current. When level shifting or wire-ORing of the comparator outputs is needed, the TLV704x with its open-drain output stage is well suited to meet the system needs. In either case, the wide operating voltage range, low quiescent current, and small size of the TLV703x and TLV704x make these comparators excellent candidates for battery-operated and portable, handheld designs.

8.1.1 Inverting Comparator With Hysteresis for TLV703x

The inverting comparator with hysteresis requires a three-resistor network that is referenced to the comparator supply voltage (V_{CC}), as shown in [图 8-1](#). When V_{IN} at the inverting input is less than V_A , the output voltage is high (for simplicity, assume V_O switches as high as V_{CC}). The three network resistors can be represented as $R1 \parallel R3$ in series with $R2$. [方程式 1](#) defines the high-to-low trip voltage (V_{A1}).

$$V_{A1} = V_{CC} \times \frac{R2}{(R1 \parallel R3) + R2} \quad (1)$$

When V_{IN} is greater than V_A , the output voltage is low, very close to ground. In this case, the three network resistors can be presented as $R2 \parallel R3$ in series with $R1$. Use [方程式 2](#) to define the low to high trip voltage (V_{A2}).

$$V_{A2} = V_{CC} \times \frac{R2 \parallel R3}{R1 + (R2 \parallel R3)} \quad (2)$$

[方程式 3](#) defines the total hysteresis provided by the network.

$$\Delta V_A = V_{A1} - V_{A2} \quad (3)$$



图 8-1. TLV703x 在具有迟滞的倒相配置中

8.1.2 Noninverting Comparator With Hysteresis for TLV703x

A noninverting comparator with hysteresis requires a two-resistor network, as shown in 图 8-2, and a voltage reference (V_{REF}) at the inverting input. When V_{IN} is low, the output is also low. For the output to switch from low to high, V_{IN} must rise to V_{IN1}. Use 方程式 4 to calculate V_{IN1}.

$$V_{IN1} = R1 \times \frac{V_{REF}}{R2} + V_{REF} \quad (4)$$

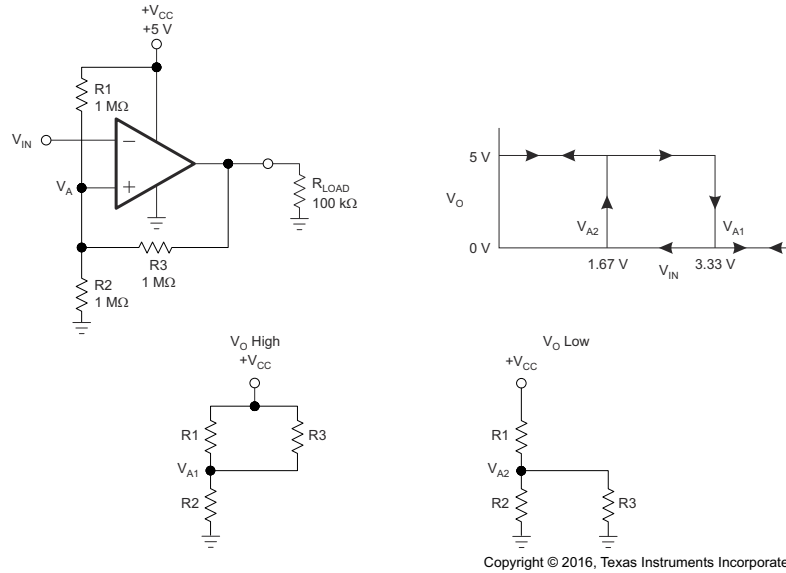
When V_{IN} is high, the output is also high. For the comparator to switch back to a low state, V_{IN} must drop to V_{IN2} such that V_A is equal to V_{REF}. Use 方程式 5 to calculate V_{IN2}.

$$V_{IN2} = \frac{V_{REF} (R1 + R2) - V_{CC} \times R1}{R2} \quad (5)$$

The hysteresis of this circuit is the difference between V_{IN1} and V_{IN2}, as shown in 方程式 6.

$$\Delta V_{IN} = V_{CC} \times \frac{R1}{R2} \quad (6)$$

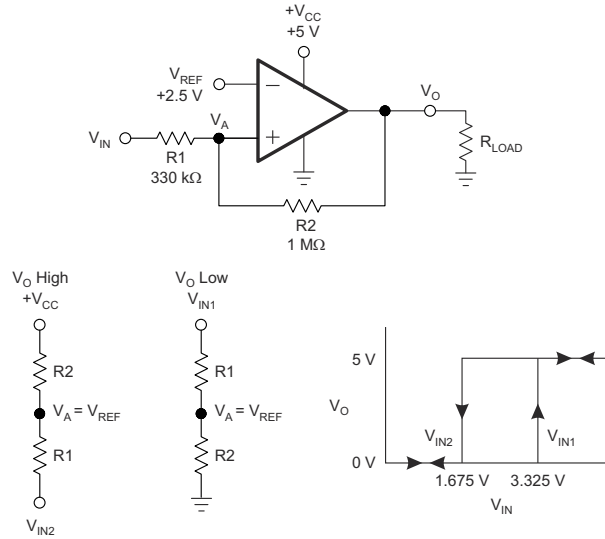

Copyright © 2016, Texas Instruments Incorporated

图 8-2. TLV703x in a Noninverting Configuration With Hysteresis

8.2 Typical Applications

8.2.1 Window Comparator

Window comparators are commonly used to detect undervoltage and overvoltage conditions. 图 8-3 shows a simple window comparator circuit.



图 8-3. TLV704x-Based Window Comparator

8.2.1.1 Design Requirements

For this design, follow these design requirements:

- Alert (logic low output) when an input signal is less than 1.1 V
- Alert (logic low output) when an input signal is greater than 2.2 V
- Alert signal is active low
- Operate from a 3.3-V power supply

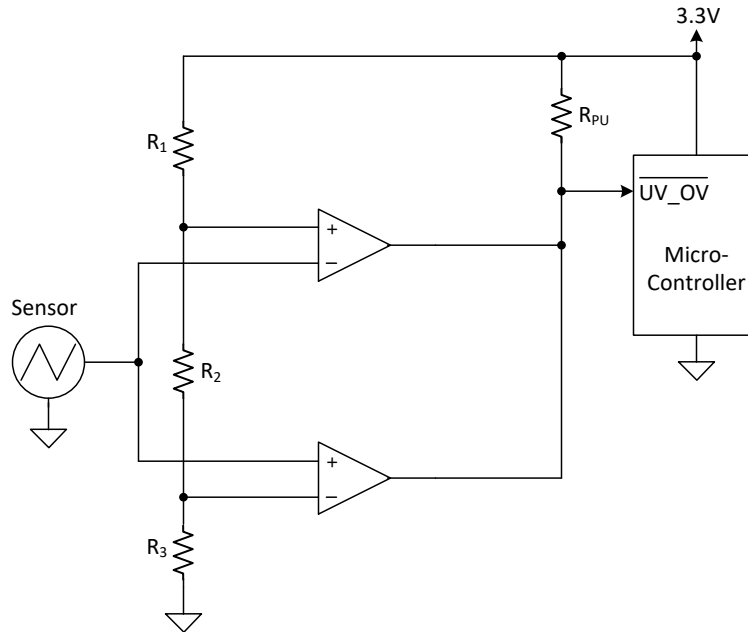
8.2.1.2 Detailed Design Procedure

Configure the circuit as shown in 图 8-3. Connect V_{CC} to a 3.3-V power supply and V_{EE} to ground. Make R_1 , R_2 , and R_3 each 10-M Ω resistors. These three resistors are used to create the positive and negative thresholds for the window comparator (V_{TH+} and V_{TH-}). With each resistor being equal, V_{TH+} is 2.2 V and V_{TH-} is 1.1 V. Large resistor values such as 10 M Ω are used to minimize power consumption. The sensor output voltage is applied to the inverting and noninverting inputs of the two TLV704x devices. The TLV704x is used for its open-drain output configuration. Using the TLV704x allows the two comparator outputs to be wire-ORed together. The respective comparator outputs are low when the sensor is less than 1.1 V or greater than 2.2 V. V_{OUT} is high when the sensor is in the range of 1.1 V to 2.2 V.

8.2.1.3 Application Curve



图 8-4. Window Comparator Results

8.2.2 IR Receiver Analog Front End

A single TLV703x device can be used to build a complete IR receiver analog front end (AFE). The nanoamp quiescent current and low input bias current make it possible to be powered with a coin cell battery, which could last for years.

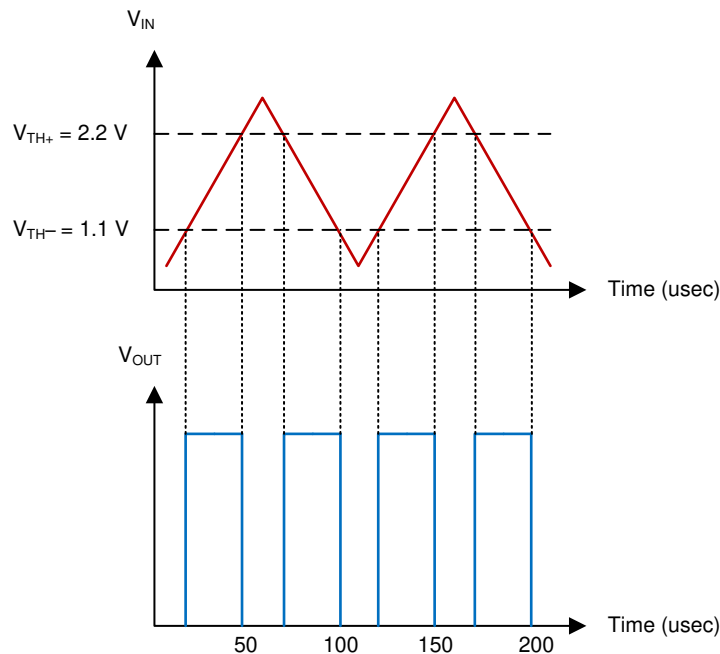
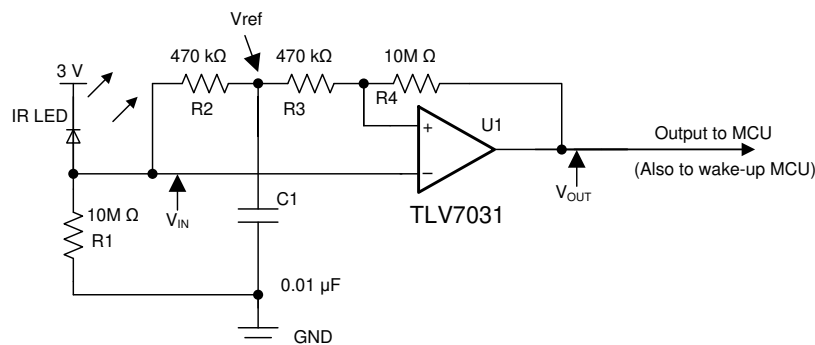

Copyright © 2017, Texas Instruments Incorporated

图 8-5. IR Receiver Analog Front End Using TLV703x

8.2.2.1 Design Requirements

For this design, follow these design requirements:

- Use a proper resistor (R_1) value to generate an adequate signal amplitude applied to the inverting input of the comparator.
- The low input bias current I_B (2 pA typical) ensures that a greater value of R_1 to be used.
- The RC constant value (R_2 and C_1) must support the targeted data rate (that is, 9,600 bauds) in order to maintain a valid tripping threshold.
- The hysteresis introduced with R_3 and R_4 helps to avoid spurious output toggles.

8.2.2.2 Detailed Design Procedure

The IR receiver AFE design is highly streamlined and optimized. R_1 converts the IR light energy induced current into voltage and applies to the inverting input of the comparator. The RC network of R_2 and C_1 establishes a reference voltage V_{ref} , which tracks the mean amplitude of the IR signal. The noninverting input is directly connected to V_{ref} through R_3 . R_3 and R_4 are used to produce a hysteresis to keep transitions free of spurious toggles. To reduce the current drain from the coin cell battery, data transmission must be short and infrequent.

More technical details are provided in the TI TechNote [Low Power Comparator for Signal Processing and Wake-Up Circuit in Smart Meters](#) (SNVA808).

8.2.2.3 Application Curve



图 8-6. IR Receiver AFE Waveforms

8.2.3 Square-Wave Oscillator

A square-wave oscillator can be used as low-cost timing reference or system supervisory clock source.

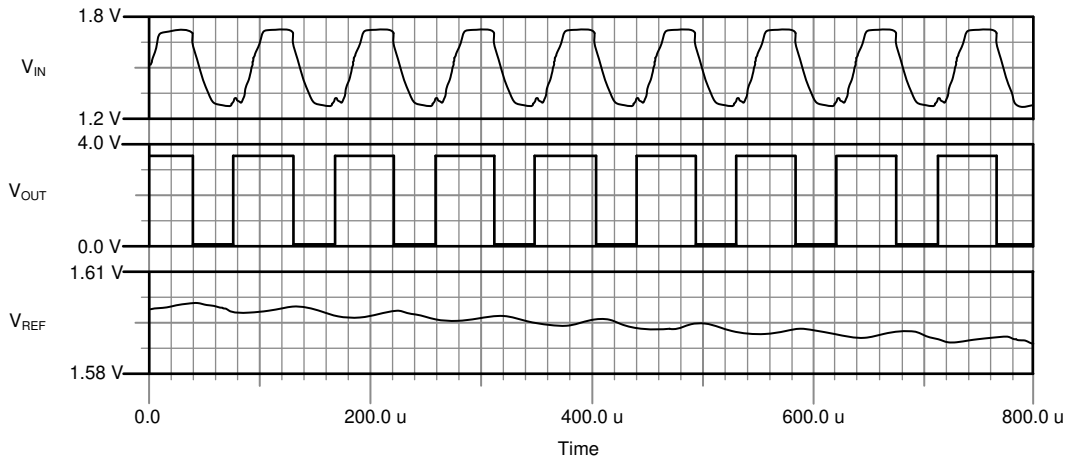

图 8-7. Square-Wave Oscillator

8.2.3.1 Design Requirements

The square-wave period is determined by the RC time constant of the capacitor and resistor. The maximum frequency is limited by the propagation delay of the device and the capacitance load at the output. The low input bias current allows a lower capacitor value and larger resistor value combination for a given oscillator frequency, which may help reduce BOM cost and board space.

8.2.3.2 Detailed Design Procedure

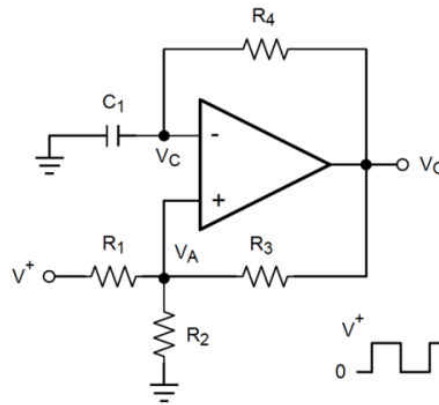
The oscillation frequency is determined by the resistor and capacitor values. The following section provides details to calculate these component values.



图 8-8. Square-Wave Oscillator Timing Thresholds

First consider the output of figure 图 8-7 is high, which indicates the inverted input V_C is lower than the noninverting input (V_A). This causes the C_1 to be charged through R_4 , and the voltage V_C increases until it is equal to the noninverting input. The value of V_A at the point is calculated by 方程式 7.

$$V_{A1} = \frac{V_{CC} \times R_2}{R_2 + R_1 + R_3} \tag{7}$$

If $R_1 = R_2 = R_3$, then $V_{A1} = 2 V_{CC} / 3$

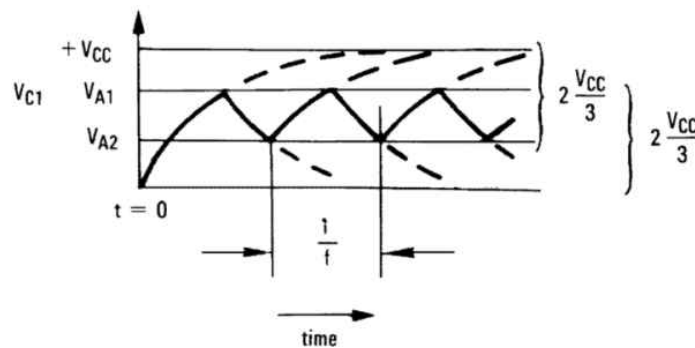
At this time the comparator output trips pulling down the output to the negative rail. The value of V_A at this point is calculated by 方程式 8.

$$V_{A2} = \frac{V_{CC}(R_2 \parallel R_3)}{R_1 + R_2 \parallel R_3} \quad (8)$$

If $R_1 = R_2 = R_3$, then $V_{A2} = V_{CC}/3$

The C_1 now discharges through the R_4 , and the voltage V_{CC} decreases until it reaches V_{A2} . At this point, the output switches back to the starting state. The oscillation period equals the time duration from $2 V_{CC} / 3$ to $V_{CC} / 3$ then back to $2 V_{CC} / 3$, which is given by $R_4 C_1 \times \ln 2$ for each trip. Therefore, the total time duration is calculated as $2 R_4 C_1 \times \ln 2$. The oscillation frequency can be obtained by 方程式 9:

$$f = 1 / (2 R_4 \times C_1 \times \ln 2) \quad (9)$$

8.2.3.3 Application Curve

图 8-9 shows the simulated results of an oscillator using the following component values:

- $R_1 = R_2 = R_3 = R_4 = 100 \text{ k}\Omega$
- $C_1 = 100 \text{ pF}$, $C_L = 20 \text{ pF}$
- $V_+ = 5 \text{ V}$, $V_- = \text{GND}$
- C_{stray} (not shown) from V_A to GND = 10 pF



图 8-9. Square-Wave Oscillator Output Waveform

8.2.4 Quadrature Rotary Encoder

A quadrature encoder for rotary motors/shafts utilizing a Tunneling Magnetoresistance (TMR) Rotation Sensor can track the position of the motor shaft even when power is turned off, while the TLV7032 provides additional hysteresis to prevent unwanted output toggling between quadrants. The TLV7032 can be used with other sensing techniques as well, such as optical, capacitive, or inductive.

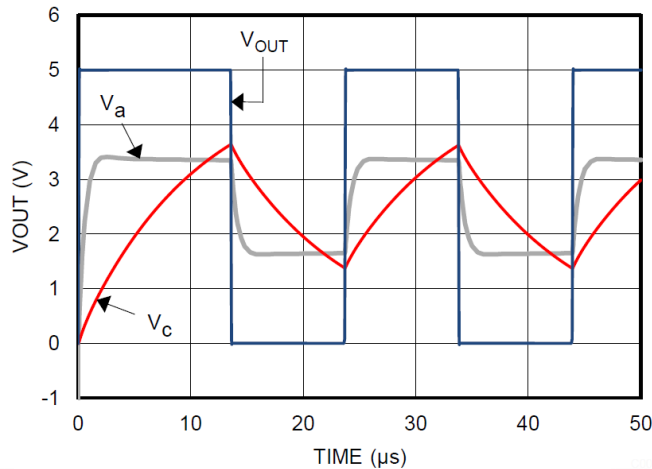

图 8-10. Quadrant Encoder Detector

8.2.4.1 Design Requirements

TMR Rotation Sensors general have two digital, binary outputs that are 90 degrees out of phase. The TLV7032 can be used to provide additional hysteresis to ensure there isn't any unwanted toggling of the output when the sensors are between the transition points of two quadrants. The TLV7032 already provides 10mV of typical internal hysteresis. By dividing down the output voltage from the rotation sensor using a voltage divider, the internal hysteresis will be scaled up by the same voltage divider ratio.

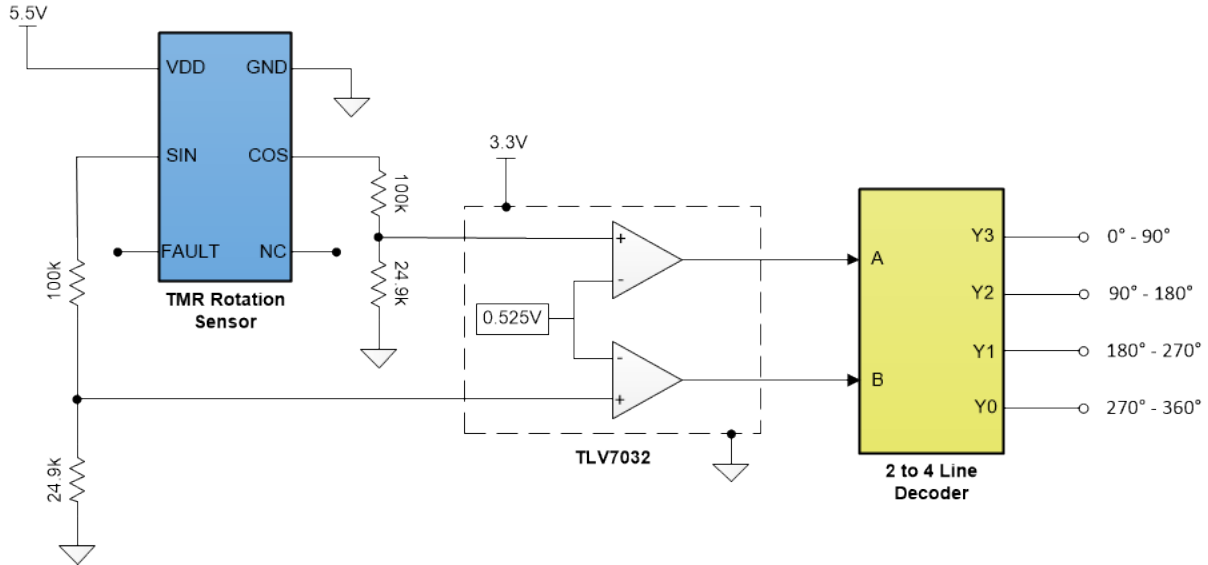

图 8-11. Voltage Divider Equation

8.2.4.2 Detailed Design Procedure

First, choose a target range of hysteresis to achieve. For this design example, 50mV of hysteresis will be the target. Since the TLV7032 already has 10mV (typ) of internal hysteresis, the voltage output from the TMR Rotation Sensor should be scaled down by a factor of 5. This way, the 10mV of internal hysteresis gets scaled up by a factor of 5, resulting in 50mV of hysteresis. The minimum output HIGH level for the TMR Rotation Sensor used in Figure 47 is 5.25 V. Since 5.25V will be the minimum output high value, it can be used to substitute V_{IN} from the Voltage Divider Equation in Figure 48. Since the voltage from the TMR rotation sensor needs to be scaled down by a factor of 5, the equation in Figure 48 can be rewritten as:

$$\frac{1}{5} = \frac{R_2}{R_1 + R_2}$$

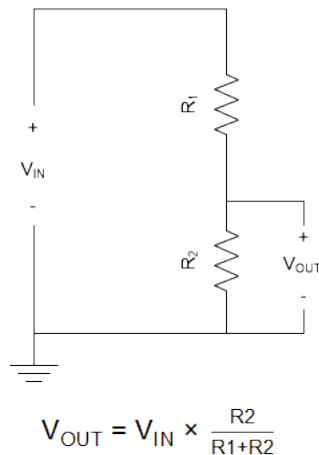
The above equation can be solved for using standard resistor values, where $R_1 = 100k\ \Omega$, and $R_2 = 24.9k\ \Omega$. The minimum voltage seen at the noninverting pins of the comparator when the output is HIGH will be 1.05V. To make the device transition at 50% output high level, the inverting pins of the TLV7032 should be tied to a 0.525V reference.

8.2.4.3 Application Curve

Figure 49 shows the TLV7032 achieving approximately 50mV of hysteresis using the following component values:

- $R_1 = 100k\ \Omega$
- $R_2 = 24.9k\ \Omega$
- $V_{REF} (IN-) = 0.525V$



图 8-12. DC Input Voltage Sweep

9 Power Supply Recommendations

The TLV703x and TLV704x have a recommended operating voltage range (V_S) of 1.6 V to 6.5 V. V_S is defined as $V_{CC} - V_{EE}$. Therefore, the supply voltages used to create V_S can be single-ended or bipolar. For example, single-ended supply voltages of 5 V and 0 V and bipolar supply voltages of +2.5 V and -2.5 V create comparable operating voltages for V_S . However, when bipolar supply voltages are used, it is important to realize that the logic low level of the comparator output is referenced to V_{EE} .

Output capacitive loading and output toggle rate will cause the average supply current to rise over the quiescent current.

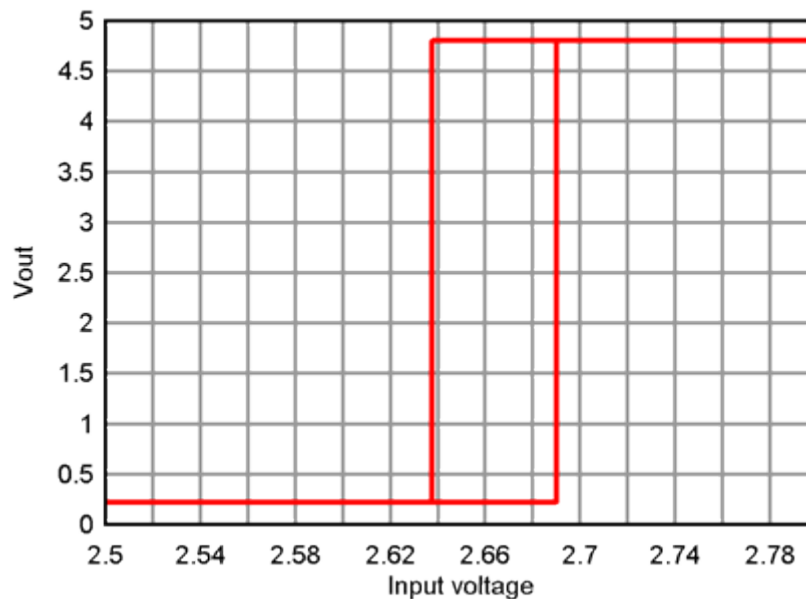
10 Layout

10.1 Layout Guidelines

To reduce PCB fabrication cost and improve reliability, TI recommends using a 4-mil via at the center pad connected to the ground trace or plane on the bottom layer.

TI recommends a power-supply bypass capacitor of 100 nF when supply output impedance is high, supply traces are long, or when excessive noise is expected on the supply lines. Bypass capacitors are also recommended when the comparator output drives a long trace or is required to drive a capacitive load. Due to the fast rising and falling edge rates and high-output sink and source capability of the TLV703x and TLV704x output stages, higher than normal quiescent current can be drawn from the power supply. Under this circumstance, the system would benefit from a bypass capacitor across the supply pins.

10.2 Layout Example



图 10-1. Layout Example

The application report [Designing and Manufacturing With TI's X2SON Packages](#) (SCEA055) helps PCB designers to achieve optimal designs.

11 Device and Documentation Support

11.1 Device Support

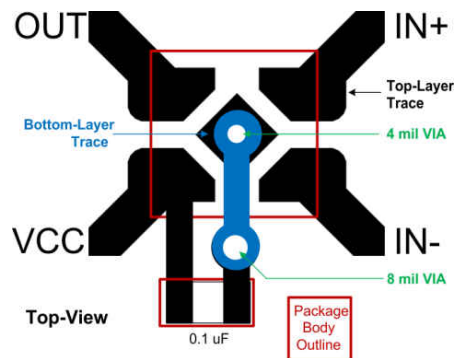
11.1.1 Development Support

11.1.1.1 Evaluation Module

An evaluation module (EVM) is available to assist in the initial circuit performance evaluation using the TLV70x1 device family. The [TLV7011 Micro-Power Comparator Dip Adaptor Evaluation Module](#) can be requested at the Texas Instruments website through the product folder or purchased directly from the TI eStore.

11.2 Documentation Support

11.2.1 Related Documentation

For related documentation, see the following:

- [Designing and Manufacturing With TI's X2SON Packages](#) (SCEA055)
- [Low Power Comparator for Signal Processing and Wake-Up Circuit in Smart Meters](#) (SNVA808)

11.3 Receiving Notification of Documentation Updates

To receive notification of documentation updates, navigate to the device product folder on ti.com. In the upper right corner, click on *Alert me* to register and receive a weekly digest of any product information that has changed. For change details, review the revision history included in any revised document.

11.4 支持资源

TI E2E™ 支持论坛是工程师的重要参考资料，可直接从专家获得快速、经过验证的解答和设计帮助。搜索现有解答或提出自己的问题可获得所需的快速设计帮助。

链接的内容由各个贡献者“按原样”提供。这些内容并不构成 TI 技术规范，并且不一定反映 TI 的观点；请参阅 TI 的《使用条款》。

11.5 Trademarks

TI E2E™ is a trademark of Texas Instruments.

所有商标均为其各自所有者的财产。

11.6 Electrostatic Discharge Caution



This integrated circuit can be damaged by ESD. Texas Instruments recommends that all integrated circuits be handled with appropriate precautions. Failure to observe proper handling and installation procedures can cause damage.

ESD damage can range from subtle performance degradation to complete device failure. Precision integrated circuits may be more susceptible to damage because very small parametric changes could cause the device not to meet its published specifications.

11.7 术语表

TI 术语表 本术语表列出并解释了术语、首字母缩略词和定义。

12 Mechanical, Packaging, and Orderable Information

The following pages include mechanical, packaging, and orderable information. This information is the most current data available for the designated devices. This data is subject to change without notice and revision of this document. For browser-based versions of this data sheet, refer to the left-hand navigation.

重要声明和免责声明

TI 提供技术和可靠性数据 (包括数据表)、设计资源 (包括参考设计)、应用或其他设计建议、网络工具、安全信息和其他资源, 不保证没有瑕疵且不做任何明示或暗示的担保, 包括但不限于对适销性、某特定用途方面的适用性或不侵犯任何第三方知识产权的暗示担保。

这些资源可供使用 TI 产品进行设计的熟练开发人员使用。您将自行承担以下全部责任: (1) 针对您的应用选择合适的 TI 产品, (2) 设计、验证并测试您的应用, (3) 确保您的应用满足相应标准以及任何其他安全、安保或其他要求。这些资源如有变更, 恕不另行通知。TI 授权您仅可将这些资源用于研发本资源所述的 TI 产品的应用。严禁对这些资源进行其他复制或展示。您无权使用任何其他 TI 知识产权或任何第三方知识产权。您应全额赔偿因在这些资源的使用中对 TI 及其代表造成的任何索赔、损害、成本、损失和债务, TI 对此概不负责。

TI 提供的产品受 TI 的销售条款 (<https://www.ti.com/legal/termsofsale.html>) 或 [ti.com](https://www.ti.com) 上其他适用条款/TI 产品随附的其他适用条款的约束。TI 提供这些资源并不会扩展或以其他方式更改 TI 针对 TI 产品发布的适用的担保或担保免责声明。

邮寄地址: Texas Instruments, Post Office Box 655303, Dallas, Texas 75265
Copyright © 2021, 德州仪器 (TI) 公司

PACKAGING INFORMATION

| Orderable Device | Status (1) | Package Type | Package Drawing | Pins | Package Qty | Eco Plan (2) | Lead finish/ Ball material (6) | MSL Peak Temp (3) | Op Temp (°C) | Device Marking (4/5) | Samples |
|------------------|---------------|--------------|-----------------|------|-------------|-----------------|--------------------------------------|----------------------|--------------|-------------------------|-------------------------|
| TLV7031DBVR | ACTIVE | SOT-23 | DBV | 5 | 3000 | RoHS & Green | NIPDAUAG SN | Level-1-260C-UNLIM | -40 to 125 | 11E2 | Samples |
| TLV7031DCKR | ACTIVE | SC70 | DCK | 5 | 3000 | RoHS & Green | NIPDAU SN | Level-2-260C-1 YEAR | -40 to 125 | 19P | Samples |
| TLV7031DCKT | ACTIVE | SC70 | DCK | 5 | 250 | RoHS & Green | NIPDAU SN | Level-2-260C-1 YEAR | -40 to 125 | 19P | Samples |
| TLV7031DPWR | ACTIVE | X2SON | DPW | 5 | 3000 | RoHS & Green | NIPDAU | Level-1-260C-UNLIM | -40 to 125 | 7K | Samples |
| TLV7032DDFR | ACTIVE | SOT-23-THIN | DDF | 8 | 3000 | RoHS & Green | NIPDAU | Level-1-260C-UNLIM | -40 to 125 | 22KF | Samples |
| TLV7032DGKR | ACTIVE | VSSOP | DGK | 8 | 2500 | RoHS & Green | NIPDAUAG SN | Level-1-260C-UNLIM | -40 to 125 | 7032 | Samples |
| TLV7032DSGR | ACTIVE | WSON | DSG | 8 | 3000 | RoHS & Green | NIPDAU | Level-1-260C-UNLIM | -40 to 125 | 1ZXH | Samples |
| TLV7034PWR | ACTIVE | TSSOP | PW | 14 | 2000 | RoHS & Green | NIPDAU | Level-1-260C-UNLIM | -40 to 125 | TLV7034 | Samples |
| TLV7034RTER | ACTIVE | WQFN | RTE | 16 | 5000 | RoHS & Green | NIPDAU | Level-1-260C-UNLIM | -40 to 125 | TL7034 | Samples |
| TLV7041DBVR | ACTIVE | SOT-23 | DBV | 5 | 3000 | RoHS & Green | NIPDAUAG SN | Level-1-260C-UNLIM | -40 to 125 | 11F2 | Samples |
| TLV7041DCKR | ACTIVE | SC70 | DCK | 5 | 3000 | RoHS & Green | NIPDAU SN | Level-2-260C-1 YEAR | -40 to 125 | 19Q | Samples |
| TLV7041DCKT | ACTIVE | SC70 | DCK | 5 | 250 | RoHS & Green | NIPDAU SN | Level-2-260C-1 YEAR | -40 to 125 | 19Q | Samples |
| TLV7041DPWR | ACTIVE | X2SON | DPW | 5 | 3000 | RoHS & Green | NIPDAU | Level-1-260C-UNLIM | -40 to 125 | 7L | Samples |
| TLV7042DDFR | ACTIVE | SOT-23-THIN | DDF | 8 | 3000 | RoHS & Green | NIPDAU | Level-1-260C-UNLIM | -40 to 125 | 22LF | Samples |
| TLV7042DGKR | ACTIVE | VSSOP | DGK | 8 | 2500 | RoHS & Green | NIPDAUAG SN | Level-1-260C-UNLIM | -40 to 125 | 7042 | Samples |
| TLV7042DSGR | ACTIVE | WSON | DSG | 8 | 3000 | RoHS & Green | NIPDAU | Level-1-260C-UNLIM | -40 to 125 | 1ZZH | Samples |
| TLV7044PWR | ACTIVE | TSSOP | PW | 14 | 2000 | RoHS & Green | NIPDAU | Level-1-260C-UNLIM | -40 to 125 | TLV7044 | Samples |
| TLV7044RTER | ACTIVE | WQFN | RTE | 16 | 5000 | RoHS & Green | NIPDAU | Level-1-260C-UNLIM | -40 to 125 | TL7044 | Samples |

⁽¹⁾ The marketing status values are defined as follows:

ACTIVE: Product device recommended for new designs.

LIFEBUY: TI has announced that the device will be discontinued, and a lifetime-buy period is in effect.

NRND: Not recommended for new designs. Device is in production to support existing customers, but TI does not recommend using this part in a new design.

PREVIEW: Device has been announced but is not in production. Samples may or may not be available.

OBSOLETE: TI has discontinued the production of the device.

⁽²⁾ **RoHS:** TI defines "RoHS" to mean semiconductor products that are compliant with the current EU RoHS requirements for all 10 RoHS substances, including the requirement that RoHS substance do not exceed 0.1% by weight in homogeneous materials. Where designed to be soldered at high temperatures, "RoHS" products are suitable for use in specified lead-free processes. TI may reference these types of products as "Pb-Free".

RoHS Exempt: TI defines "RoHS Exempt" to mean products that contain lead but are compliant with EU RoHS pursuant to a specific EU RoHS exemption.

Green: TI defines "Green" to mean the content of Chlorine (Cl) and Bromine (Br) based flame retardants meet JS709B low halogen requirements of <=1000ppm threshold. Antimony trioxide based flame retardants must also meet the <=1000ppm threshold requirement.

⁽³⁾ **MSL, Peak Temp.** - The Moisture Sensitivity Level rating according to the JEDEC industry standard classifications, and peak solder temperature.

⁽⁴⁾ There may be additional marking, which relates to the logo, the lot trace code information, or the environmental category on the device.

⁽⁵⁾ Multiple Device Markings will be inside parentheses. Only one Device Marking contained in parentheses and separated by a "~" will appear on a device. If a line is indented then it is a continuation of the previous line and the two combined represent the entire Device Marking for that device.

⁽⁶⁾ **Lead finish/Ball material** - Orderable Devices may have multiple material finish options. Finish options are separated by a vertical ruled line. Lead finish/Ball material values may wrap to two lines if the finish value exceeds the maximum column width.

Important Information and Disclaimer:The information provided on this page represents TI's knowledge and belief as of the date that it is provided. TI bases its knowledge and belief on information provided by third parties, and makes no representation or warranty as to the accuracy of such information. Efforts are underway to better integrate information from third parties. TI has taken and continues to take reasonable steps to provide representative and accurate information but may not have conducted destructive testing or chemical analysis on incoming materials and chemicals. TI and TI suppliers consider certain information to be proprietary, and thus CAS numbers and other limited information may not be available for release.

In no event shall TI's liability arising out of such information exceed the total purchase price of the TI part(s) at issue in this document sold by TI to Customer on an annual basis.

OTHER QUALIFIED VERSIONS OF TLV7031, TLV7032, TLV7034, TLV7041, TLV7042, TLV7044 :

- Automotive : [TLV7031-Q1](#), [TLV7032-Q1](#), [TLV7034-Q1](#), [TLV7041-Q1](#), [TLV7042-Q1](#), [TLV7044-Q1](#)

NOTE: Qualified Version Definitions:

- Automotive - Q100 devices qualified for high-reliability automotive applications targeting zero defects

TAPE AND REEL INFORMATION

QUADRANT ASSIGNMENTS FOR PIN 1 ORIENTATION IN TAPE

*All dimensions are nominal

| Device | Package Type | Package Drawing | Pins | SPQ | Reel Diameter (mm) | Reel Width W1 (mm) | A0 (mm) | B0 (mm) | K0 (mm) | P1 (mm) | W (mm) | Pin1 Quadrant |
|-------------|--------------|-----------------|------|------|--------------------|--------------------|---------|---------|---------|---------|--------|---------------|
| TLV7031DBVR | SOT-23 | DBV | 5 | 3000 | 180.0 | 8.4 | 3.23 | 3.17 | 1.37 | 4.0 | 8.0 | Q3 |
| TLV7031DCKR | SC70 | DCK | 5 | 3000 | 180.0 | 8.4 | 2.3 | 2.5 | 1.2 | 4.0 | 8.0 | Q3 |
| TLV7031DCKT | SC70 | DCK | 5 | 250 | 180.0 | 8.4 | 2.3 | 2.5 | 1.2 | 4.0 | 8.0 | Q3 |
| TLV7031DPWR | X2SON | DPW | 5 | 3000 | 178.0 | 8.4 | 0.91 | 0.91 | 0.5 | 2.0 | 8.0 | Q2 |
| TLV7032DDFR | SOT-23-THIN | DDF | 8 | 3000 | 180.0 | 8.4 | 3.2 | 3.2 | 1.4 | 4.0 | 8.0 | Q3 |
| TLV7032DGKR | VSSOP | DGK | 8 | 2500 | 330.0 | 12.4 | 5.3 | 3.4 | 1.4 | 8.0 | 12.0 | Q1 |
| TLV7032DSGR | WSON | DSG | 8 | 3000 | 180.0 | 8.4 | 2.3 | 2.3 | 1.15 | 4.0 | 8.0 | Q2 |
| TLV7034PWR | TSSOP | PW | 14 | 2000 | 330.0 | 12.4 | 6.9 | 5.6 | 1.6 | 8.0 | 12.0 | Q1 |
| TLV7034RTER | WQFN | RTE | 16 | 5000 | 330.0 | 12.4 | 3.3 | 3.3 | 1.1 | 8.0 | 12.0 | Q2 |
| TLV7041DBVR | SOT-23 | DBV | 5 | 3000 | 180.0 | 8.4 | 3.2 | 3.2 | 1.4 | 4.0 | 8.0 | Q3 |
| TLV7041DBVR | SOT-23 | DBV | 5 | 3000 | 180.0 | 8.4 | 3.23 | 3.17 | 1.37 | 4.0 | 8.0 | Q3 |
| TLV7041DCKR | SC70 | DCK | 5 | 3000 | 178.0 | 9.0 | 2.4 | 2.5 | 1.2 | 4.0 | 8.0 | Q3 |
| TLV7041DCKR | SC70 | DCK | 5 | 3000 | 180.0 | 8.4 | 2.3 | 2.5 | 1.2 | 4.0 | 8.0 | Q3 |
| TLV7041DCKT | SC70 | DCK | 5 | 250 | 178.0 | 9.0 | 2.4 | 2.5 | 1.2 | 4.0 | 8.0 | Q3 |
| TLV7041DPWR | X2SON | DPW | 5 | 3000 | 178.0 | 8.4 | 0.91 | 0.91 | 0.5 | 2.0 | 8.0 | Q2 |

| Device | Package Type | Package Drawing | Pins | SPQ | Reel Diameter (mm) | Reel Width W1 (mm) | A0 (mm) | B0 (mm) | K0 (mm) | P1 (mm) | W (mm) | Pin1 Quadrant |
|-------------|--------------|-----------------|------|------|--------------------|--------------------|---------|---------|---------|---------|--------|---------------|
| TLV7042DDFR | SOT-23-THIN | DDF | 8 | 3000 | 180.0 | 8.4 | 3.2 | 3.2 | 1.4 | 4.0 | 8.0 | Q3 |
| TLV7042DGKR | VSSOP | DGK | 8 | 2500 | 330.0 | 12.4 | 5.3 | 3.4 | 1.4 | 8.0 | 12.0 | Q1 |
| TLV7042DSGR | WSON | DSG | 8 | 3000 | 180.0 | 8.4 | 2.3 | 2.3 | 1.15 | 4.0 | 8.0 | Q2 |
| TLV7044PWR | TSSOP | PW | 14 | 2000 | 330.0 | 12.4 | 6.9 | 5.6 | 1.6 | 8.0 | 12.0 | Q1 |
| TLV7044RTER | WQFN | RTE | 16 | 5000 | 330.0 | 12.4 | 3.3 | 3.3 | 1.1 | 8.0 | 12.0 | Q2 |

TAPE AND REEL BOX DIMENSIONS

*All dimensions are nominal

| Device | Package Type | Package Drawing | Pins | SPQ | Length (mm) | Width (mm) | Height (mm) |
|-------------|--------------|-----------------|------|------|-------------|------------|-------------|
| TLV7031DBVR | SOT-23 | DBV | 5 | 3000 | 183.0 | 183.0 | 20.0 |
| TLV7031DCKR | SC70 | DCK | 5 | 3000 | 210.0 | 185.0 | 35.0 |
| TLV7031DCKT | SC70 | DCK | 5 | 250 | 210.0 | 185.0 | 35.0 |
| TLV7031DPWR | X2SON | DPW | 5 | 3000 | 205.0 | 200.0 | 33.0 |
| TLV7032DDFR | SOT-23-THIN | DDF | 8 | 3000 | 210.0 | 185.0 | 35.0 |
| TLV7032DGKR | VSSOP | DGK | 8 | 2500 | 366.0 | 364.0 | 50.0 |
| TLV7032DSGR | WSON | DSG | 8 | 3000 | 210.0 | 185.0 | 35.0 |
| TLV7034PWR | TSSOP | PW | 14 | 2000 | 356.0 | 356.0 | 35.0 |
| TLV7034RTER | WQFN | RTE | 16 | 5000 | 367.0 | 367.0 | 35.0 |
| TLV7041DBVR | SOT-23 | DBV | 5 | 3000 | 210.0 | 185.0 | 35.0 |
| TLV7041DBVR | SOT-23 | DBV | 5 | 3000 | 183.0 | 183.0 | 20.0 |
| TLV7041DCKR | SC70 | DCK | 5 | 3000 | 190.0 | 190.0 | 30.0 |
| TLV7041DCKR | SC70 | DCK | 5 | 3000 | 210.0 | 185.0 | 35.0 |
| TLV7041DCKT | SC70 | DCK | 5 | 250 | 190.0 | 190.0 | 30.0 |
| TLV7041DPWR | X2SON | DPW | 5 | 3000 | 205.0 | 200.0 | 33.0 |
| TLV7042DDFR | SOT-23-THIN | DDF | 8 | 3000 | 210.0 | 185.0 | 35.0 |
| TLV7042DGKR | VSSOP | DGK | 8 | 2500 | 366.0 | 364.0 | 50.0 |
| TLV7042DSGR | WSON | DSG | 8 | 3000 | 210.0 | 185.0 | 35.0 |

| Device | Package Type | Package Drawing | Pins | SPQ | Length (mm) | Width (mm) | Height (mm) |
|-------------|--------------|-----------------|------|------|-------------|------------|-------------|
| TLV7044PWR | TSSOP | PW | 14 | 2000 | 356.0 | 356.0 | 35.0 |
| TLV7044RTER | WQFN | RTE | 16 | 5000 | 367.0 | 367.0 | 35.0 |

GENERIC PACKAGE VIEW

DPW 5

X2SON - 0.4 mm max height

PLASTIC SMALL OUTLINE - NO LEAD



Images above are just a representation of the package family, actual package may vary.
Refer to the product data sheet for package details.

4211218-3/D

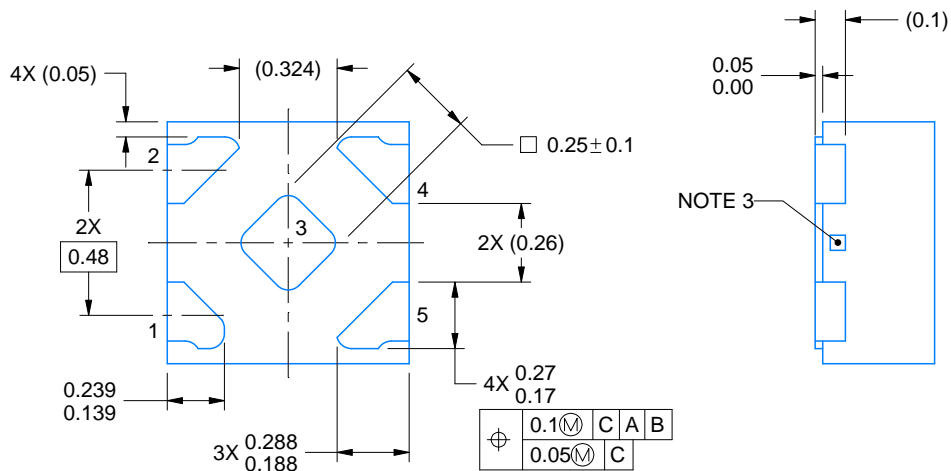
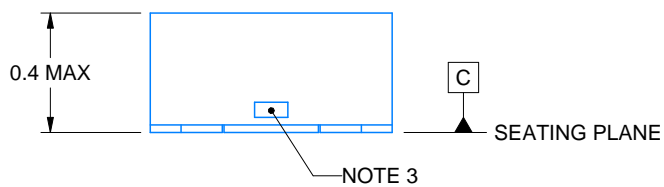
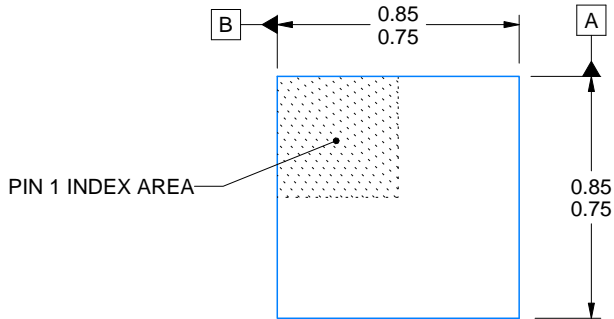
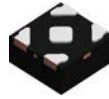

4223102/D 03/2022

NOTES:

1. All linear dimensions are in millimeters. Any dimensions in parenthesis are for reference only. Dimensioning and tolerancing per ASME Y14.5M.
2. This drawing is subject to change without notice.
3. The size and shape of this feature may vary.

EXAMPLE BOARD LAYOUT

DPW0005A

X2SON - 0.4 mm max height

PLASTIC SMALL OUTLINE - NO LEAD

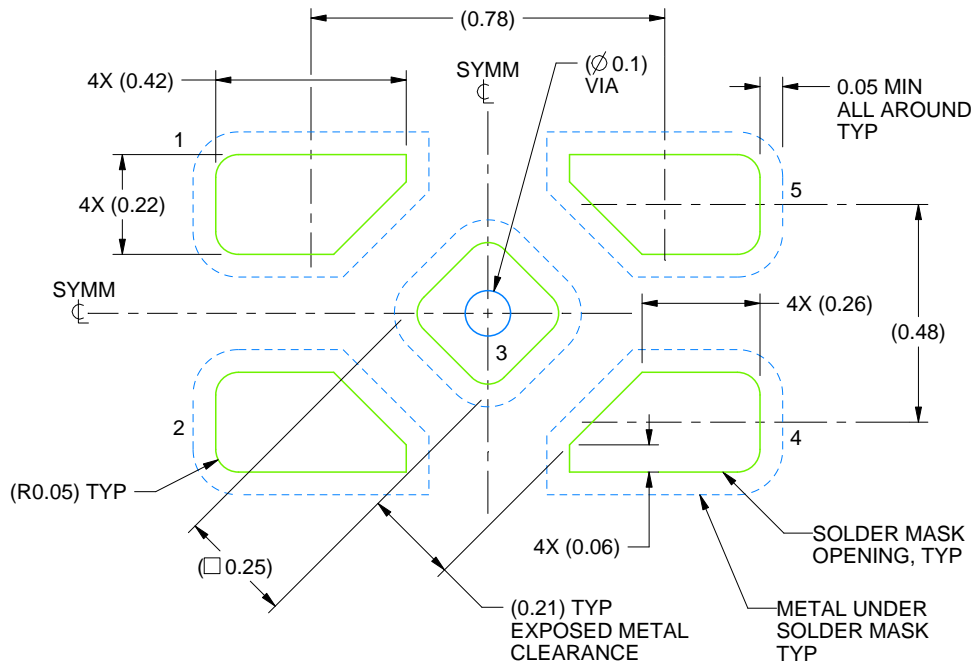

LAND PATTERN EXAMPLE
SOLDER MASK DEFINED
SCALE:60X

4223102/D 03/2022

NOTES: (continued)

4. This package is designed to be soldered to a thermal pad on the board. For more information, refer to QFN/SON PCB application note in literature No. SLUA271 (www.ti.com/lit/slua271).

EXAMPLE STENCIL DESIGN

DPW0005A

X2SON - 0.4 mm max height

PLASTIC SMALL OUTLINE - NO LEAD

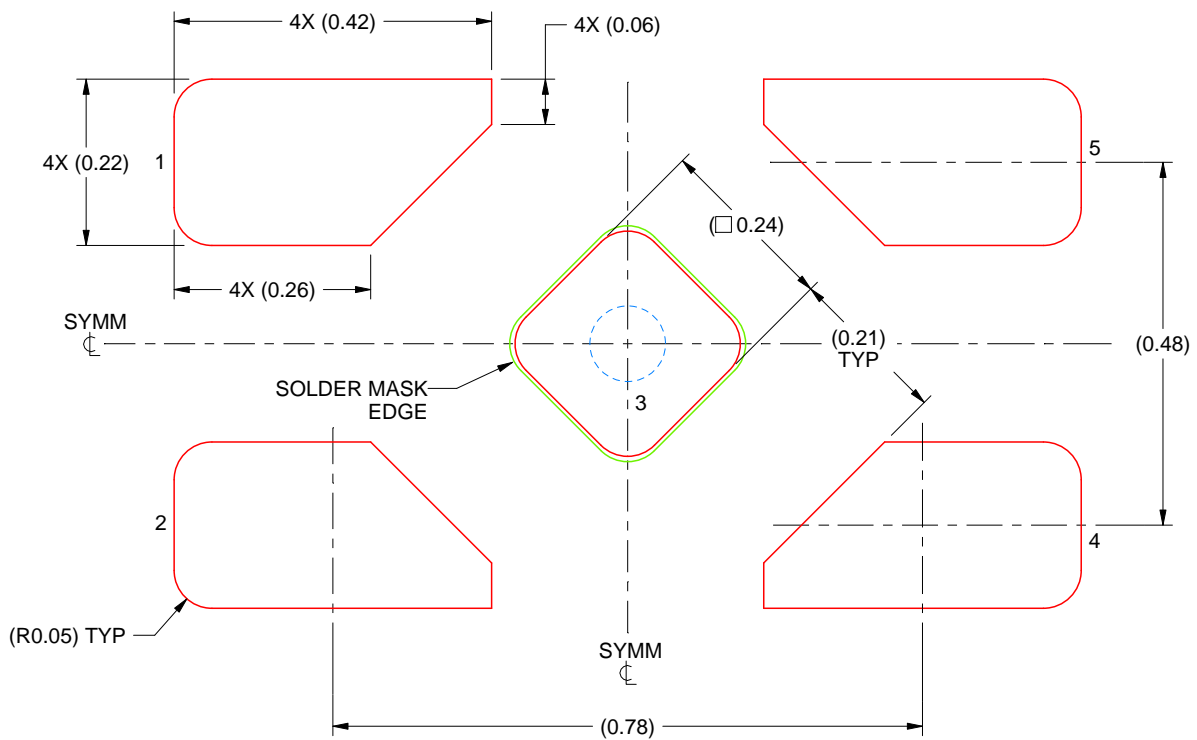

SOLDER PASTE EXAMPLE
BASED ON 0.1 mm THICK STENCIL

EXPOSED PAD 3
92% PRINTED SOLDER COVERAGE BY AREA UNDER PACKAGE
SCALE:100X

4223102/D 03/2022

NOTES: (continued)

5. Laser cutting apertures with trapezoidal walls and rounded corners may offer better paste release. IPC-7525 may have alternate design recommendations.

DBV0005A



PACKAGE OUTLINE

SOT-23 - 1.45 mm max height

SMALL OUTLINE TRANSISTOR



NOTES:

1. All linear dimensions are in millimeters. Any dimensions in parenthesis are for reference only. Dimensioning and tolerancing per ASME Y14.5M.
2. This drawing is subject to change without notice.
3. Reference JEDEC MO-178.
4. Body dimensions do not include mold flash, protrusions, or gate burrs. Mold flash, protrusions, or gate burrs shall not exceed 0.25 mm per side.
5. Support pin may differ or may not be present.

EXAMPLE BOARD LAYOUT

DBV0005A

SOT-23 - 1.45 mm max height

SMALL OUTLINE TRANSISTOR



LAND PATTERN EXAMPLE
EXPOSED METAL SHOWN
SCALE:15X

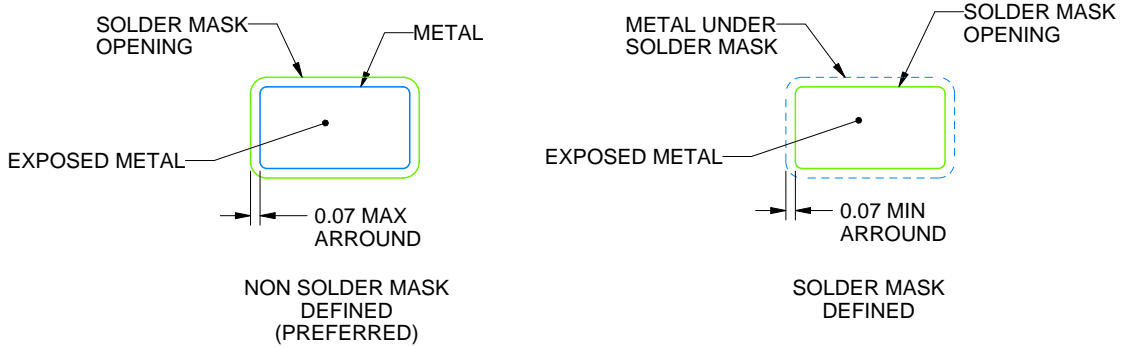

SOLDER MASK DETAILS

4214839/H 09/2023

NOTES: (continued)

6. Publication IPC-7351 may have alternate designs.

7. Solder mask tolerances between and around signal pads can vary based on board fabrication site.

EXAMPLE STENCIL DESIGN

DBV0005A

SOT-23 - 1.45 mm max height

SMALL OUTLINE TRANSISTOR



SOLDER PASTE EXAMPLE
BASED ON 0.125 mm THICK STENCIL
SCALE:15X

4214839/H 09/2023

NOTES: (continued)

8. Laser cutting apertures with trapezoidal walls and rounded corners may offer better paste release. IPC-7525 may have alternate design recommendations.
9. Board assembly site may have different recommendations for stencil design.

PW (R-PDSO-G14)

PLASTIC SMALL OUTLINE



4040064-3/G 02/11

- NOTES:
- A. All linear dimensions are in millimeters. Dimensioning and tolerancing per ASME Y14.5M-1994.
 - B. This drawing is subject to change without notice.
 -  Body length does not include mold flash, protrusions, or gate burrs. Mold flash, protrusions, or gate burrs shall not exceed 0,15 each side.
 -  Body width does not include interlead flash. Interlead flash shall not exceed 0,25 each side.
 - E. Falls within JEDEC MO-153

PW (R-PDSO-G14)

PLASTIC SMALL OUTLINE



- NOTES:
- All linear dimensions are in millimeters.
 - This drawing is subject to change without notice.
 - Publication IPC-7351 is recommended for alternate designs.
 - Laser cutting apertures with trapezoidal walls and also rounding corners will offer better paste release. Customers should contact their board assembly site for stencil design recommendations. Refer to IPC-7525 for other stencil recommendations.
 - Customers should contact their board fabrication site for solder mask tolerances between and around signal pads.

DGK (S-PDSO-G8)

PLASTIC SMALL-OUTLINE PACKAGE



- NOTES:
- A. All linear dimensions are in millimeters.
 - B. This drawing is subject to change without notice.
 - C. Body length does not include mold flash, protrusions, or gate burrs. Mold flash, protrusions, or gate burrs shall not exceed 0.15 per end.
 - D. Body width does not include interlead flash. Interlead flash shall not exceed 0.50 per side.
 - E. Falls within JEDEC MO-187 variation AA, except interlead flash.

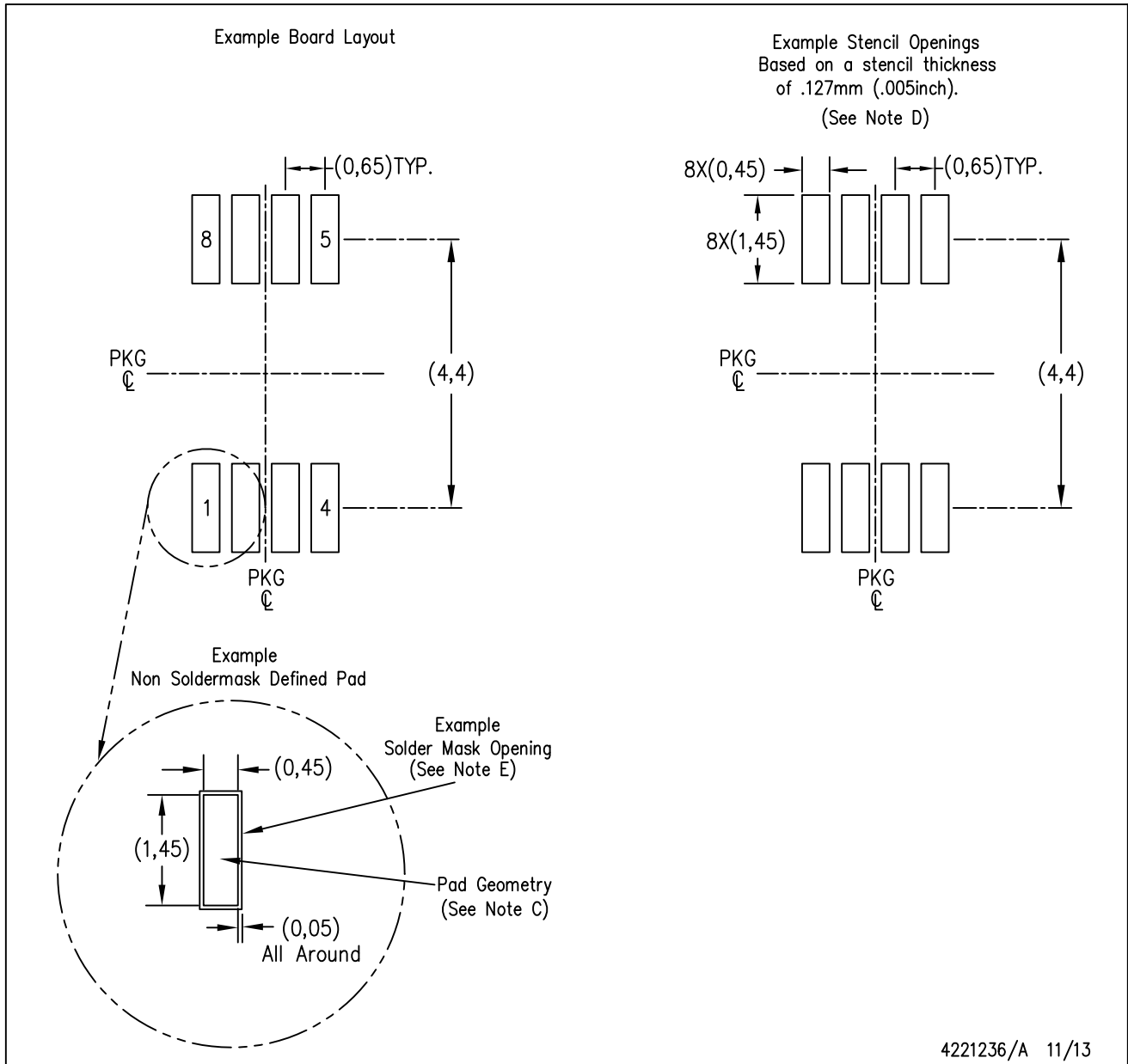

- NOTES:
- All linear dimensions are in millimeters.
 - This drawing is subject to change without notice.
 - Publication IPC-7351 is recommended for alternate designs.
 - Laser cutting apertures with trapezoidal walls and also rounding corners will offer better paste release. Customers should contact their board assembly site for stencil design recommendations. Refer to IPC-7525 for other stencil recommendations.
 - Customers should contact their board fabrication site for solder mask tolerances between and around signal pads.

GENERIC PACKAGE VIEW

DSG 8

WSON - 0.8 mm max height

2 x 2, 0.5 mm pitch

PLASTIC SMALL OUTLINE - NO LEAD

This image is a representation of the package family, actual package may vary.
Refer to the product data sheet for package details.

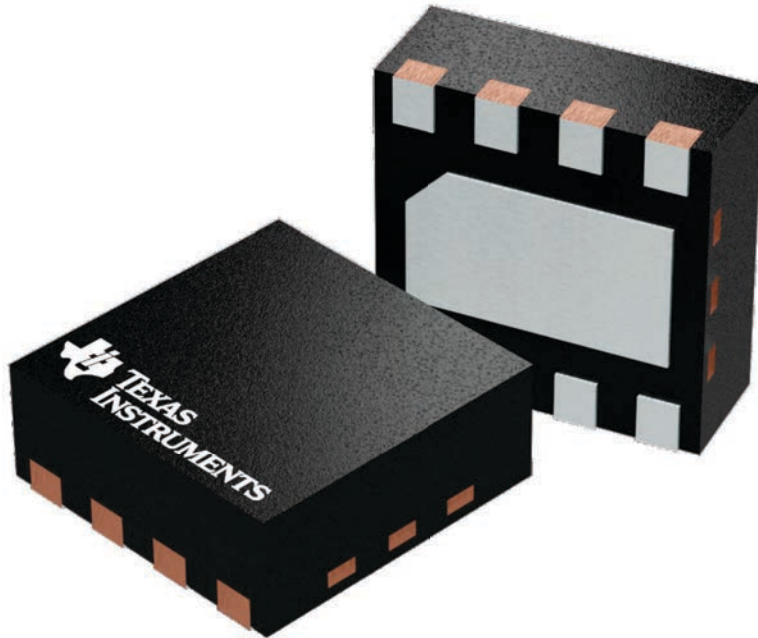

4224783/A

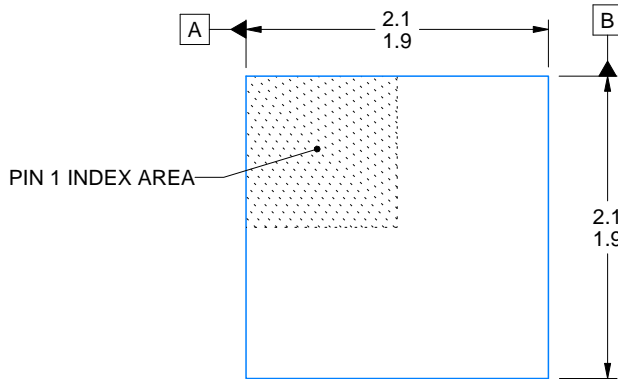
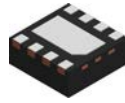

ALTERNATIVE TERMINAL SHAPE TYPICAL



| SIDE WALL METAL THICKNESS DIM A | |
|---------------------------------|----------|
| OPTION 1 | OPTION 2 |
| 0.1 | 0.2 |

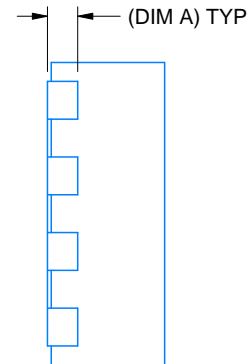
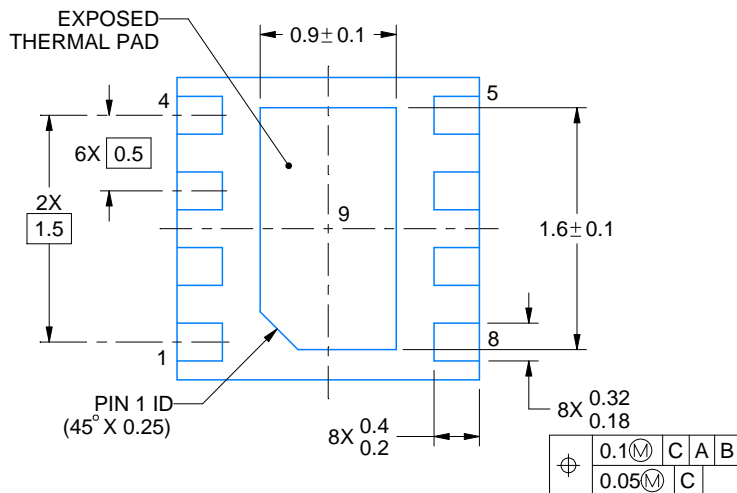

4218900/E 08/2022

NOTES:

1. All linear dimensions are in millimeters. Any dimensions in parenthesis are for reference only. Dimensioning and tolerancing per ASME Y14.5M.
2. This drawing is subject to change without notice.
3. The package thermal pad must be soldered to the printed circuit board for thermal and mechanical performance.

EXAMPLE BOARD LAYOUT

DSG0008A

WSON - 0.8 mm max height

PLASTIC SMALL OUTLINE - NO LEAD



LAND PATTERN EXAMPLE
SCALE:20X



SOLDER MASK DETAILS

4218900/E 08/2022

NOTES: (continued)

4. This package is designed to be soldered to a thermal pad on the board. For more information, see Texas Instruments literature number SLUA271 (www.ti.com/lit/slua271).
5. Vias are optional depending on application, refer to device data sheet. If any vias are implemented, refer to their locations shown on this view. It is recommended that vias under paste be filled, plugged or tented.

EXAMPLE STENCIL DESIGN

DSG0008A

WSON - 0.8 mm max height

PLASTIC SMALL OUTLINE - NO LEAD



SOLDER PASTE EXAMPLE
BASED ON 0.125 mm THICK STENCIL

EXPOSED PAD 9:
87% PRINTED SOLDER COVERAGE BY AREA UNDER PACKAGE
SCALE:25X

4218900/E 08/2022

NOTES: (continued)

6. Laser cutting apertures with trapezoidal walls and rounded corners may offer better paste release. IPC-7525 may have alternate design recommendations.

DCK0005A



PACKAGE OUTLINE

SOT - 1.1 max height

SMALL OUTLINE TRANSISTOR



4214834/C 03/2023

NOTES:

1. All linear dimensions are in millimeters. Any dimensions in parenthesis are for reference only. Dimensioning and tolerancing per ASME Y14.5M.
2. This drawing is subject to change without notice.
3. Reference JEDEC MO-203.
4. Support pin may differ or may not be present.

EXAMPLE BOARD LAYOUT

DCK0005A

SOT - 1.1 max height

SMALL OUTLINE TRANSISTOR

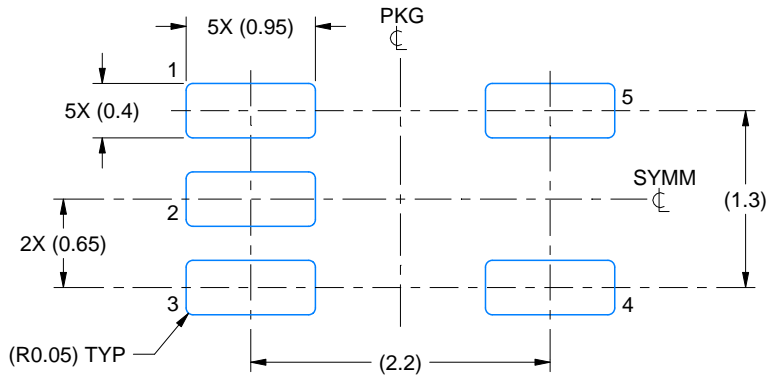

LAND PATTERN EXAMPLE
EXPOSED METAL SHOWN
SCALE:18X



SOLDER MASK DETAILS

4214834/C 03/2023

NOTES: (continued)

- 4. Publication IPC-7351 may have alternate designs.
- 5. Solder mask tolerances between and around signal pads can vary based on board fabrication site.

EXAMPLE STENCIL DESIGN

DCK0005A

SOT - 1.1 max height

SMALL OUTLINE TRANSISTOR



SOLDER PASTE EXAMPLE
BASED ON 0.125 THICK STENCIL
SCALE:18X

4214834/C 03/2023

NOTES: (continued)

6. Laser cutting apertures with trapezoidal walls and rounded corners may offer better paste release. IPC-7525 may have alternate design recommendations.
7. Board assembly site may have different recommendations for stencil design.

DDF0008A



PACKAGE OUTLINE

SOT-23 - 1.1 mm max height

PLASTIC SMALL OUTLINE

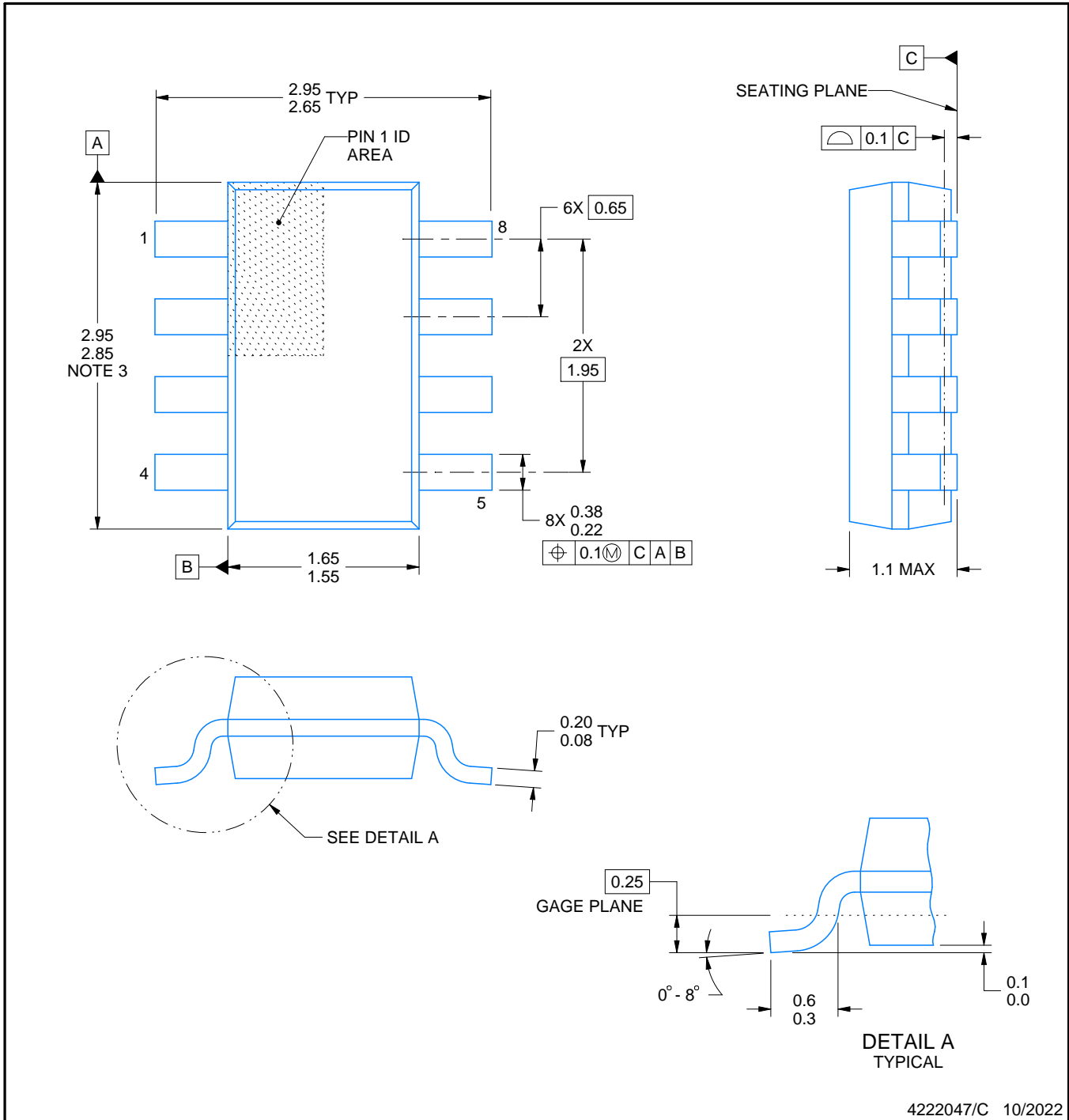

4222047/C 10/2022

NOTES:

1. All linear dimensions are in millimeters. Any dimensions in parenthesis are for reference only. Dimensioning and tolerancing per ASME Y14.5M.
2. This drawing is subject to change without notice.
3. This dimension does not include mold flash, protrusions, or gate burrs. Mold flash, protrusions, or gate burrs shall not exceed 0.15 mm per side.

EXAMPLE BOARD LAYOUT

DDF0008A

SOT-23 - 1.1 mm max height

PLASTIC SMALL OUTLINE

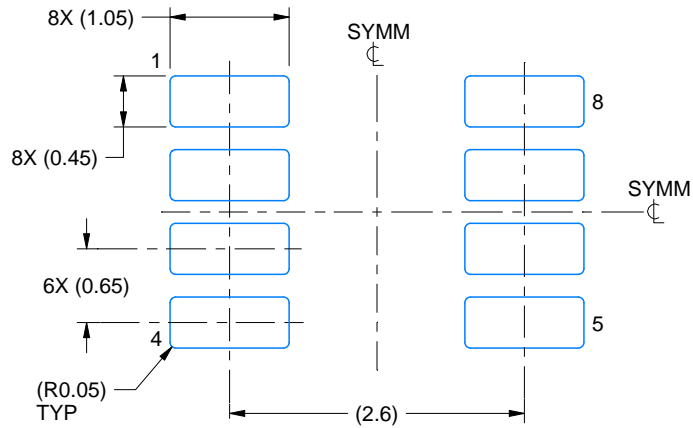

LAND PATTERN EXAMPLE
SCALE:15X

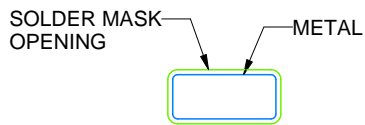

NON SOLDER MASK
DEFINED

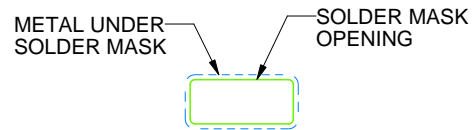

SOLDER MASK
DEFINED

SOLDER MASK DETAILS

4222047/C 10/2022

NOTES: (continued)

4. Publication IPC-7351 may have alternate designs.
5. Solder mask tolerances between and around signal pads can vary based on board fabrication site.

EXAMPLE STENCIL DESIGN

DDF0008A

SOT-23 - 1.1 mm max height

PLASTIC SMALL OUTLINE



SOLDER PASTE EXAMPLE
BASED ON 0.125 mm THICK STENCIL
SCALE:15X

4222047/C 10/2022

NOTES: (continued)

6. Laser cutting apertures with trapezoidal walls and rounded corners may offer better paste release. IPC-7525 may have alternate design recommendations.
7. Board assembly site may have different recommendations for stencil design.

GENERIC PACKAGE VIEW

RTE 16

WQFN - 0.8 mm max height

3 x 3, 0.5 mm pitch

PLASTIC QUAD FLATPACK - NO LEAD

This image is a representation of the package family, actual package may vary.
Refer to the product data sheet for package details.

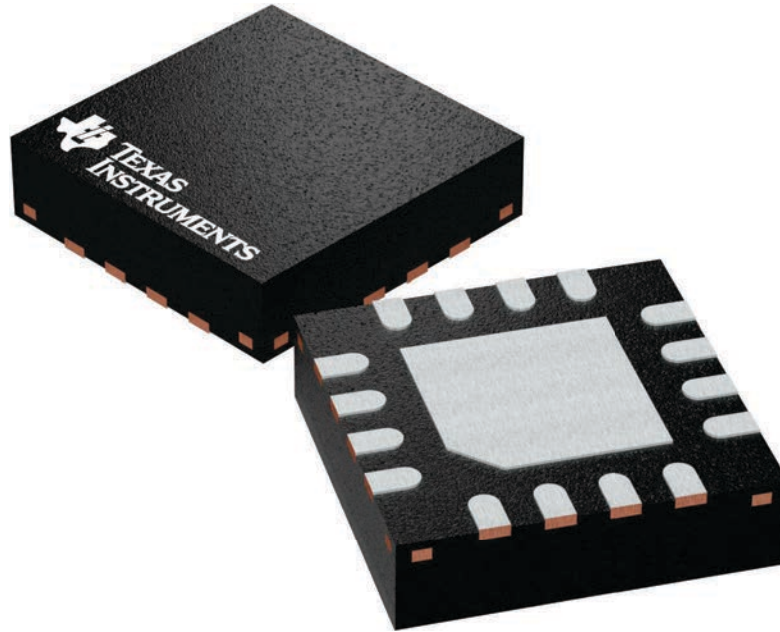

4225944/A



| SIDE WALL METAL THICKNESS DIM A | |
|---------------------------------|----------|
| OPTION 1 | OPTION 2 |
| 0.1 | 0.2 |

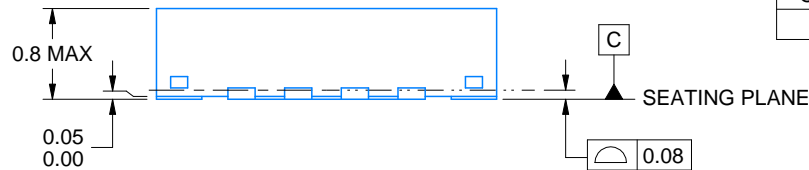

4219117/B 04/2022

NOTES:

1. All linear dimensions are in millimeters. Any dimensions in parenthesis are for reference only. Dimensioning and tolerancing per ASME Y14.5M.
2. This drawing is subject to change without notice.
3. The package thermal pad must be soldered to the printed circuit board for thermal and mechanical performance.

EXAMPLE BOARD LAYOUT

RTE0016C

WQFN - 0.8 mm max height

PLASTIC QUAD FLATPACK - NO LEAD

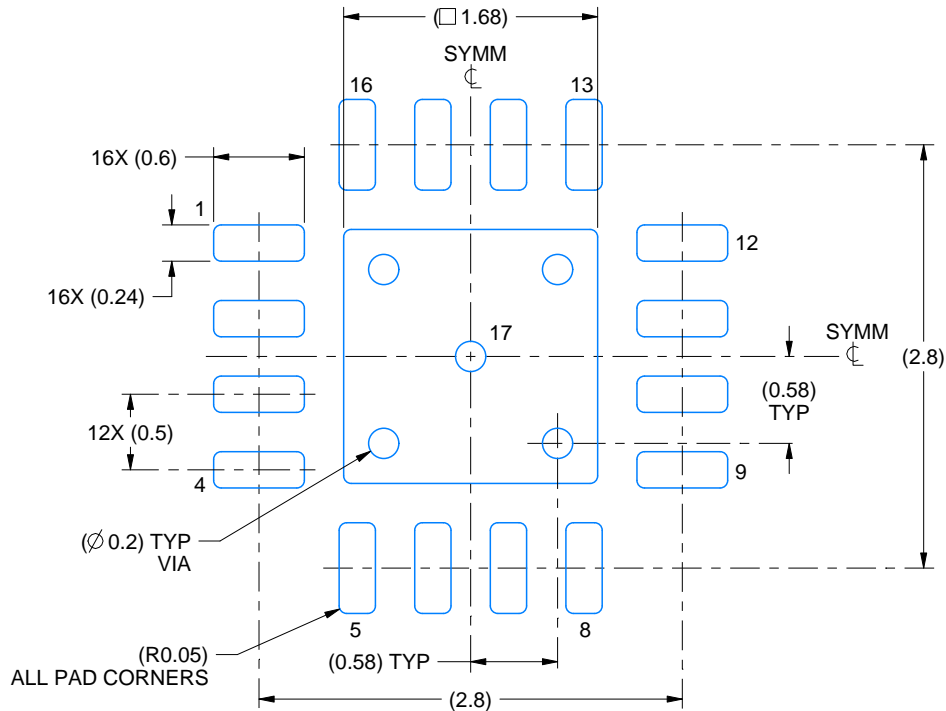

LAND PATTERN EXAMPLE
EXPOSED METAL SHOWN
SCALE:20X

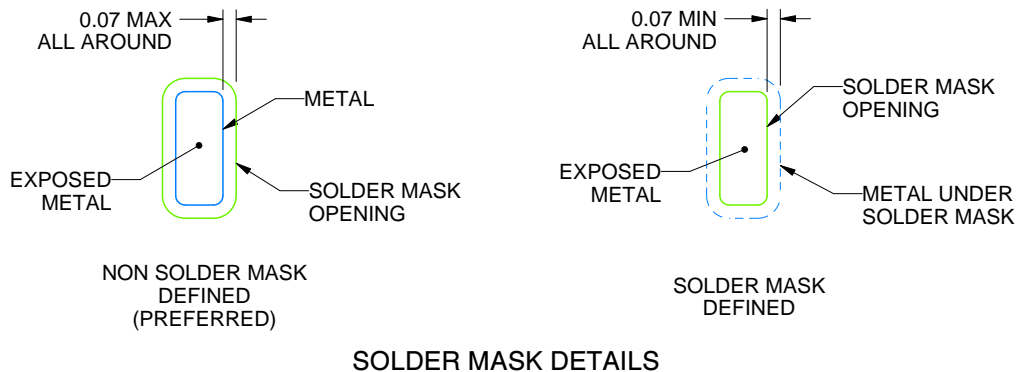

SOLDER MASK DETAILS

4219117/B 04/2022

NOTES: (continued)

- This package is designed to be soldered to a thermal pad on the board. For more information, see Texas Instruments literature number SLUA271 (www.ti.com/lit/slua271).
- Vias are optional depending on application, refer to device data sheet. If any vias are implemented, refer to their locations shown on this view. It is recommended that vias under paste be filled, plugged or tented.

EXAMPLE STENCIL DESIGN

RTE0016C

WQFN - 0.8 mm max height

PLASTIC QUAD FLATPACK - NO LEAD

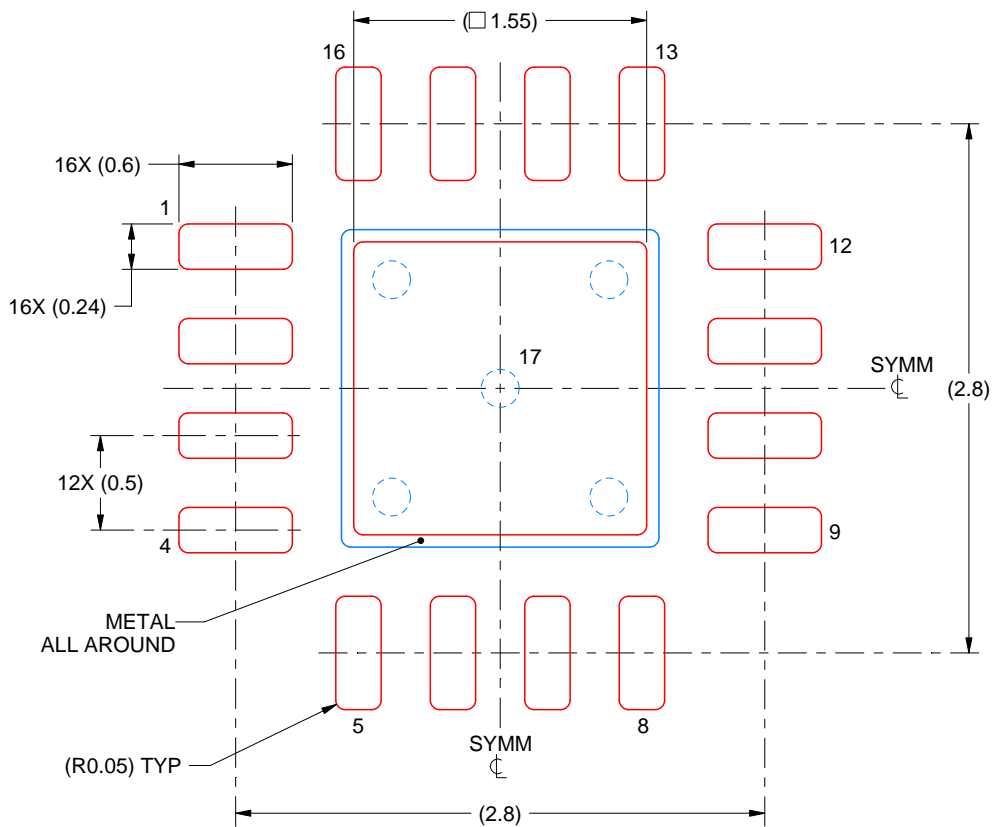

SOLDER PASTE EXAMPLE
BASED ON 0.125 mm THICK STENCIL

EXPOSED PAD 17:
85% PRINTED SOLDER COVERAGE BY AREA UNDER PACKAGE
SCALE:25X

4219117/B 04/2022

NOTES: (continued)

6. Laser cutting apertures with trapezoidal walls and rounded corners may offer better paste release. IPC-7525 may have alternate design recommendations.

重要声明和免责声明

TI“按原样”提供技术和可靠性数据（包括数据表）、设计资源（包括参考设计）、应用或其他设计建议、网络工具、安全信息和其他资源，不保证没有瑕疵且不做任何明示或暗示的担保，包括但不限于对适销性、某特定用途方面的适用性或不侵犯任何第三方知识产权的暗示担保。

这些资源可供使用 TI 产品进行设计的熟练开发人员使用。您将自行承担以下全部责任：(1) 针对您的应用选择合适的 TI 产品，(2) 设计、验证并测试您的应用，(3) 确保您的应用满足相应标准以及任何其他功能安全、信息安全、监管或其他要求。

这些资源如有变更，恕不另行通知。TI 授权您仅可将这些资源用于研发本资源所述的 TI 产品的应用。严禁对这些资源进行其他复制或展示。您无权使用任何其他 TI 知识产权或任何第三方知识产权。您应全额赔偿因在这些资源的使用中对 TI 及其代表造成的任何索赔、损害、成本、损失和债务，TI 对此概不负责。

TI 提供的产品受 [TI 的销售条款](#) 或 [ti.com](#) 上其他适用条款/TI 产品随附的其他适用条款的约束。TI 提供这些资源并不会扩展或以其他方式更改 TI 针对 TI 产品发布的适用的担保或担保免责声明。

TI 反对并拒绝您可能提出的任何其他或不同的条款。

邮寄地址：Texas Instruments, Post Office Box 655303, Dallas, Texas 75265

Copyright © 2023，德州仪器 (TI) 公司

单击下面可查看定价，库存，交付和生命周期等信息

[>>TI\(德州仪器\)](#)