

1 μ A, Rail-to-Rail I/O CMOS OPERATIONAL AMPLIFIERS

FEATURES

- **LOW SUPPLY CURRENT:** 1 μ A
- **GAIN-BANDWIDTH:** 70kHz
- **UNITY-GAIN STABLE**
- **LOW INPUT BIAS CURRENT:** 10pA (max)
- **WIDE SUPPLY RANGE:** 1.8V to 5.5V
- **INPUT RANGE:** 200mV Beyond Rails
- **OUTPUT SWINGS TO 350mV OF RAILS**
- **OUTPUT DRIVE CURRENT:** 8mA
- **OPEN-LOOP GAIN:** 90dB
- **MicroPACKAGES:** SC70, SOT23-5, SOT23-8

APPLICATIONS

- **BATTERY PACKS AND POWER SUPPLIES**
- **PORTABLE PHONES, PAGERS, AND CAMERAS**
- **SOLAR-POWERED SYSTEMS**
- **SMOKE, GAS, AND FIRE DETECTION SYSTEMS**
- **REMOTE SENSORS**
- **PCMCIA CARDS**
- **DRIVING ANALOG-TO-DIGITAL (A/D) CONVERTERS**
- **MicroPOWER FILTERS**

OPAx349 RELATED PRODUCTS

FEATURES	PRODUCT
1 μ A, 5.5kHz, Rail-To-Rail	TLV240x
1 μ A, 5.5kHz, Rail-To-Rail	TLV224x
7 μ A, 160kHz, Rail-To-Rail, 2.7V to 16V Supply	TLV238x
7 μ A, 160kHz, Rail-To-Rail, Micro Power	TLV27Lx
20 μ A, 500kHz, Rail-To-Rail, 1.8V Micro Power	TLV276x
20 μ A, 350kHz, Rail-To-Rail, Micro Power	OPAx347
45 μ A, 1MHz, Rail-To-Rail, 2.1V to 5.5V Supply	OPAx348

DESCRIPTION

The OPA349 and OPA2349 are ultra-low power operational amplifiers that provide 70kHz bandwidth with only 1 μ A quiescent current. These rail-to-rail input and output amplifiers are specifically designed for battery-powered applications. The input common-mode voltage range extends 200mV beyond the power-supply rails and the output swings to within 350mV of the rails, maintaining wide dynamic range. Unlike some micropower op amps, these parts are unity-gain stable and require no external compensation to achieve wide bandwidth. The OPA349 features a low input bias current that allows the use of large source and feedback resistors.

The OPA349 can be operated with power supplies from 1.8V to 5.5V with little change in performance, ensuring continuing superior performance even in low battery situations.

The OPA349 comes in miniature SOT23-5, SC70, and SO-8 surface-mount packages. The OPA2349 dual is available in SOT23-8, and SO-8 surface-mount packages. These tiny packages are ideal for use in high-density applications, such as PCMCIA cards, battery packs, and portable instruments.

The OPA349 is specified for 0°C to +70°C. The OPA2349 is specified for –40°C to +70°C.

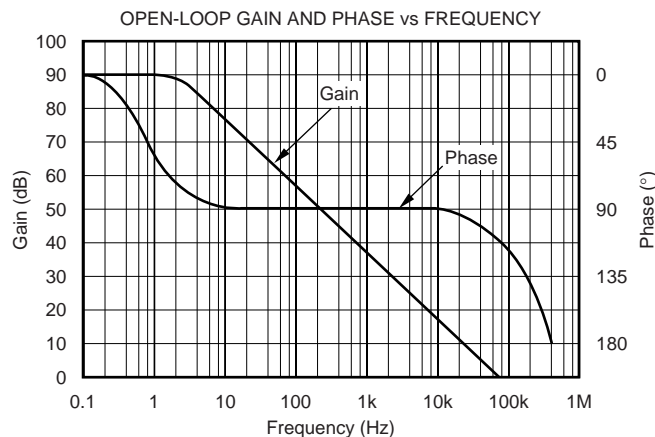

Please be aware that an important notice concerning availability, standard warranty, and use in critical applications of Texas Instruments semiconductor products and disclaimers thereto appears at the end of this data sheet.

All trademarks are the property of their respective owners.

ABSOLUTE MAXIMUM RATINGS⁽¹⁾

Supply Voltage, V+ to V-.....	5.5V
Signal Input Terminals, Voltage ⁽²⁾	(V-) - 0.5V to (V+) + 0.5V
Current ⁽²⁾	10mA
Output Short Circuit ⁽³⁾	Continuous
Operating Temperature, OPA2349.....	-55°C to +125°C
Operating Temperature, OPA349.....	0°C to +85°C
Storage Temperature.....	-65°C to +150°C
Junction Temperature.....	150°C
Lead Temperature (soldering, 3s).....	300°C

NOTES: (1) Stresses above these ratings may cause permanent damage. Exposure to absolute maximum conditions for extended periods may degrade device reliability. These are stress ratings only, and functional operation of the device at these, or any other conditions beyond those specified, is not implied. (2) Input terminals are diode-clamped to the power-supply rails. Input signals that can swing more than 0.5V beyond the supply rails should be current-limited to 10mA or less. (3) Short-circuit to ground, one amplifier per package.



ELECTROSTATIC DISCHARGE SENSITIVITY

This integrated circuit can be damaged by ESD. Texas Instruments recommends that all integrated circuits be handled with appropriate precautions. Failure to observe proper handling and installation procedures can cause damage.

ESD damage can range from subtle performance degradation to complete device failure. Precision integrated circuits may be more susceptible to damage because very small parametric changes could cause the device not to meet its published specifications.

PACKAGE/ORDERING INFORMATION⁽¹⁾

PRODUCT	PACKAGE	PACKAGE DESIGNATOR ⁽¹⁾	PACKAGE MARKING	ORDERING NUMBER	TRANSPORT MEDIA, QUANTITY
Single					
OPA349NA	SOT23-5	DBV	A49	OPA349NA/250	Tape and Reel, 250
"	"	"	"	OPA349NA/3K	Tape and Reel, 3000
OPA349UA	SO-8	D	OPA349UA	OPA349UA	Rails, 100
"	"	"	"	OPA349UA/2K5	Tape and Reel, 2500
OPA349SA	SC70-5	DCK	S49	OPA349SA/250	Tape and Reel, 250
"	"	"	"	OPA349SA/3K	Tape and Reel, 3000
Dual					
OPA2349EA	SOT23-8	DCN	C49	OPA2349EA/250	Tape and Reel, 250
"	"	"	"	OPA2349EA/3K	Tape and Reel, 3000
OPA2349UA	SO-8	D	OPA2349UA	OPA2349UA	Rails, 100
"	"	"	"	OPA2349UA/2K5	Tape and Reel, 2500

NOTE: (1) For the most current package and ordering information, see the Package Option Addendum located at the end of this data sheet.

PIN CONFIGURATIONS

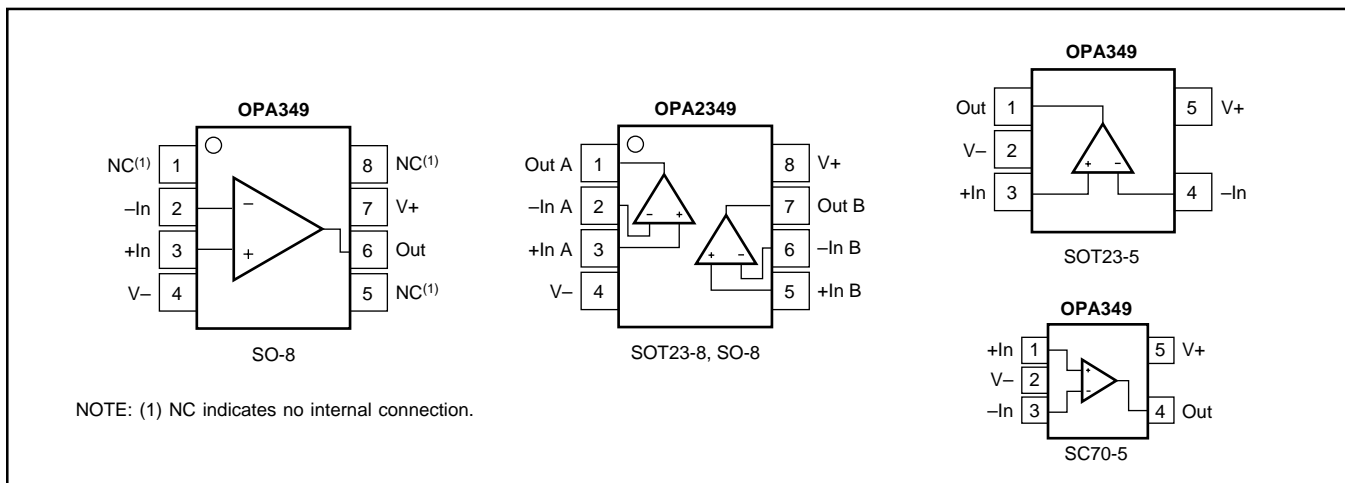

ELECTRICAL CHARACTERISTICS (Single): $V_S = +1.8V$ to $+5.5V$

Boldface limits apply over the specified temperature range, $T_A = 0^\circ C$ to $+70^\circ C$.

At $T_A = +25^\circ C$, and $R_L = 1M\Omega$ connected to $V_S/2$, unless otherwise noted.

PARAMETER	CONDITION	OPA349			UNITS
		MIN	TYP ⁽¹⁾	MAX	
OFFSET VOLTAGE Input Offset Voltage Over Temperature Drift vs Power-Supply Rejection Ratio Over Temperature	V_{OS} $V_S = 5V, V_{CM} = 2.5V$ $V_S = 1.8V$ to $5.5V, V_{CM} = (V-) + 0.3V$		± 2 ± 2 ± 15 350	± 10 ± 13 1000 3000	mV mV $\mu V/^\circ C$ $\mu V/V$ $\mu V/V$
INPUT VOLTAGE RANGE Common-Mode Voltage Range Common-Mode Rejection Ratio Over Temperature Over Temperature	V_{CM} CMRR $V_S = +5V, -0.2V < V_{CM} < 5.2V$ $V_S = +5V, -0.2V < V_{CM} < 3.5V$	$(V-) - 0.2$ 48 46 52 50	60 72	$(V+) + 0.2$ 	V dB dB dB dB
INPUT BIAS CURRENT Input Bias Current Input Offset Current	I_B I_{OS}		± 0.5 ± 1	± 10 ± 10	pA pA
INPUT IMPEDANCE Differential Common-Mode			$10^{13} \parallel 2$ $10^{13} \parallel 4$		$\Omega \parallel pF$ $\Omega \parallel pF$
NOISE Input Voltage Noise, $f = 0.1Hz$ to $10Hz$ Input Voltage Noise Density, $f = 1kHz$ Current Noise Density, $f = 1kHz$	e_n i_n		8 300 4		$\mu Vp-p$ nV/\sqrt{Hz} fA/\sqrt{Hz}
OPEN-LOOP GAIN Open-Loop Voltage Gain Over Temperature Open-Loop Voltage Gain Over Temperature	A_{OL} A_{OL}	$R_L = 1M\Omega, V_S = +5.5V, +0.3V < V_O < +5.2V$ $R_L = 10k\Omega, V_S = +5.5V, +0.35V < V_O < +5.15V$	74 72 74 60	90 90	dB dB dB dB
OUTPUT Voltage Output Swing from Rail Over Temperature Over Temperature Output Current Short-Circuit Current Capacitive Load Drive	 I_{SC} C_{LOAD}	$R_L = 1M\Omega, V_S = +5.5V, A_{OL} > 74dB$ $R_L = 10k\Omega, V_S = +5.5V, A_{OL} > 74dB$		 ± 8 ± 10 See Typical Characteristics	mV mV mV mV mA mA
FREQUENCY RESPONSE Gain-Bandwidth Product Slew Rate Settling Time, 0.1% 0.01% Overload Recovery Time	GBW SR t_s	$C_L = 10pF$ $G = +1$ $V_S = +5V, G = +1$ $V_S = 5V, 1V$ Step $V_S = 5V, 1V$ Step $V_{IN} \cdot \text{Gain} = V_S$	70 0.02 65 80 5		kHz V/ μs μs μs μs
POWER SUPPLY Specified Voltage Range Quiescent Current (per amplifier) Over Temperature	V_S I_Q	$I_Q = 0$	+1.8 1	+5.5 2 10	V μA μA
TEMPERATURE RANGE Specified Range Operating Range Storage Range Thermal Resistance SOT23-5 Surface-Mount SO-8 Surface-Mount SC70-5 Surface-Mount	θ_{JA}		0 0 -65 200 150 250	+70 +85 +150 	$^\circ C$ $^\circ C$ $^\circ C$ $^\circ C/W$ $^\circ C/W$ $^\circ C/W$

NOTE: (1) Refer to Typical Characteristic curves.

ELECTRICAL CHARACTERISTICS (Dual): $V_S = +1.8V$ to $+5.5V$

Boldface limits apply over the specified temperature range, $T_A = -40^{\circ}C$ to $+70^{\circ}C$.

At $T_A = +25^{\circ}C$, and $R_L = 1M\Omega$ connected to $V_S/2$, unless otherwise noted.

PARAMETER	CONDITION	OPA2349			UNITS
		MIN	TYP ⁽¹⁾	MAX	
OFFSET VOLTAGE Input Offset Voltage Over Temperature Drift vs Power Supply Over Temperature Channel Separation, dc	V_{OS} dV_{OS}/dT PSRR $R_L = 100k\Omega$ $f = 1kHz$	$V_S = 5V, V_{CM} = 2.5V$ $V_S = 1.8V$ to $5.5V, V_{CM} = (V-) + 0.3V$	± 2 ± 2 ± 15 350 10 66 ⁽¹⁾	± 10 ± 13 1000 3000	mV mV $\mu V/^{\circ}C$ $\mu V/V$ $\mu V/V$ dB
INPUT VOLTAGE RANGE Common-Mode Voltage Range Common-Mode Rejection Ratio Over Temperature Over Temperature	V_{CM} CMRR	$V_S = +5V, -0.2V < V_{CM} < 5.2V$ $V_S = +5V, -0.2V < V_{CM} < 3.5V$	$(V-) - 0.2$ 48 46 52 50	$(V+) + 0.2$	V dB dB dB dB
INPUT BIAS CURRENT Input Bias Current Input Offset Current	I_B I_{OS}		± 0.5 ± 1	± 10 ± 10	pA pA
INPUT IMPEDANCE Differential Common-Mode			$10^{13} \parallel 2$ $10^{13} \parallel 4$		$\Omega \parallel pF$ $\Omega \parallel pF$
NOISE Input Voltage Noise, $f = 0.1Hz$ to $10Hz$ Input Voltage Noise Density, $f = 1kHz$ Current Noise Density, $f = 1kHz$	e_n i_n		8 300 4		$\mu Vp-p$ nV/\sqrt{Hz} fA/\sqrt{Hz}
OPEN-LOOP GAIN Open-Loop Voltage Gain Over Temperature Open-Loop Voltage Gain Over Temperature	A_{OL} A_{OL}	$R_L = 1M\Omega, V_S = +5.5V, +0.3V < V_O < +5.2V$ $R_L = 10k\Omega, V_S = +5.5V, +0.35V < V_O < +5.15V$	74 72 74 60	90 90	dB dB dB dB
OUTPUT Voltage Output Swing from Rail Over Temperature Over Temperature Output Current Short-Circuit Current	I_{SC}	$R_L = 1M\Omega, V_S = +5.5V, A_{OL} > 74dB$ $R_L = 10k\Omega, V_S = +5.5V, A_{OL} > 74dB$	150 200 ± 8 ± 10	300 300 350 350	mV mV mV mA mA
FREQUENCY RESPONSE Gain-Bandwidth Product Slew Rate Settling Time, 0.1% 0.01% Overload Recovery Time	GBW SR t_s	$C_L = 10pF$ $G = +1$ $V_S = +5V, G = +1$ $V_S = 5V, 1V$ Step $V_S = 5V, 1V$ Step $V_{IN} \cdot Gain = V_S$	70 0.02 65 80 5		kHz V/ μs μs μs μs
POWER SUPPLY Specified Voltage Range Quiescent Current (per amplifier) Over Temperature	V_S I_Q	$I_O = 0$	+1.8 1	+5.5 2 10	V μA μA
TEMPERATURE RANGE Specified Range Operating Range Storage Range Thermal Resistance SOT23-8 Surface-Mount SO-8 Surface-Mount	θ_{JA}		-40 -40 -65 200 150	+70 +85 +150	$^{\circ}C$ $^{\circ}C$ $^{\circ}C$ $^{\circ}C/W$ $^{\circ}C/W$

NOTE: (1) Refer to Typical Characteristic curves.

TYPICAL CHARACTERISTICS

At $T_A = +25^\circ\text{C}$, $V_S = +5\text{V}$, and $R_L = 1\text{M}\Omega$ connected to $V_{G/2}$, unless otherwise noted.

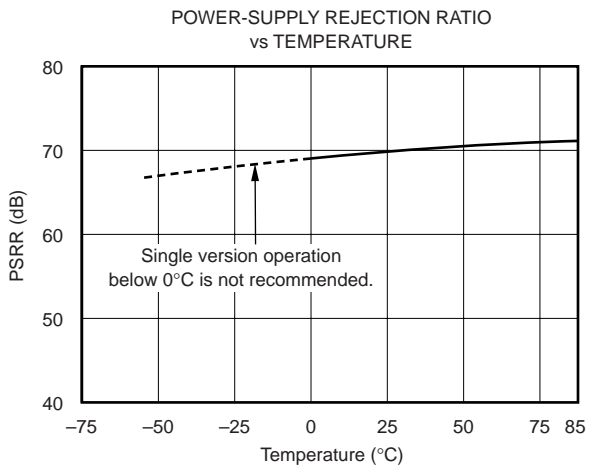
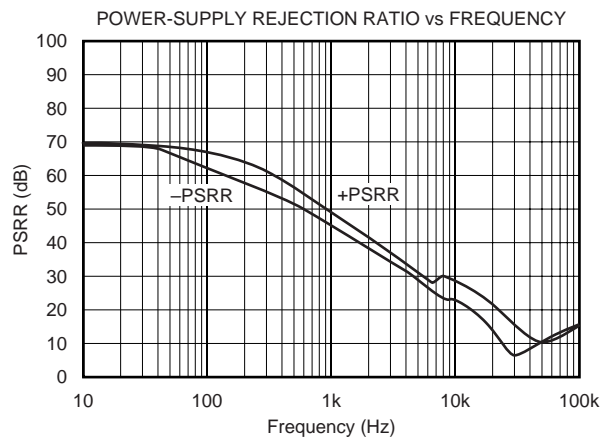
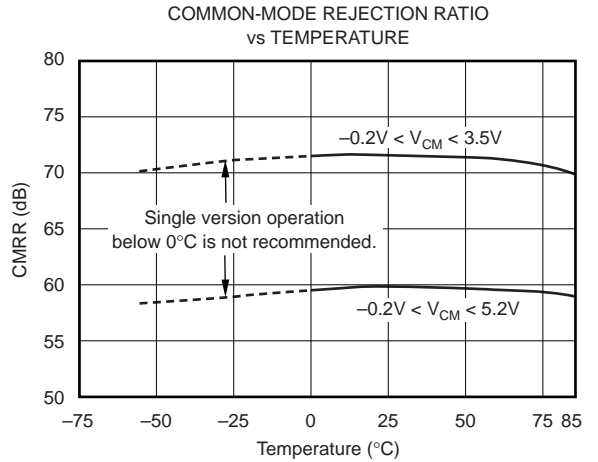
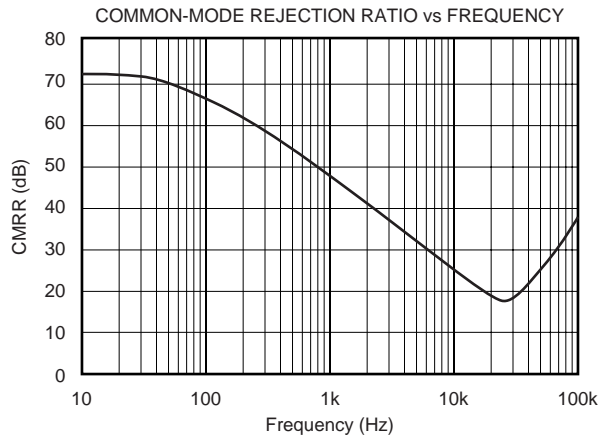
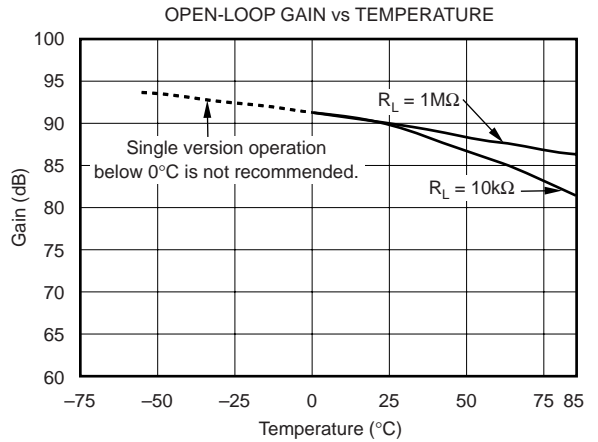
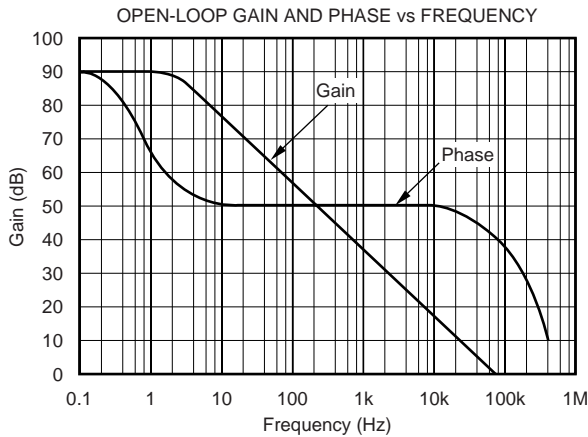

TYPICAL CHARACTERISTICS (Cont.)

At $T_A = +25^\circ\text{C}$, $V_S = +5\text{V}$, and $R_L = 1\text{M}\Omega$ connected to $V_S/2$, unless otherwise noted.

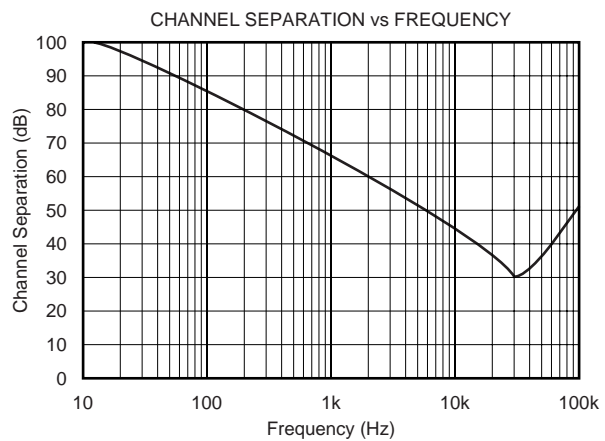
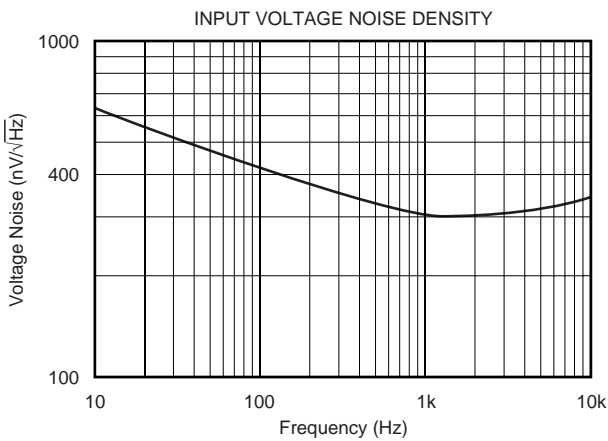
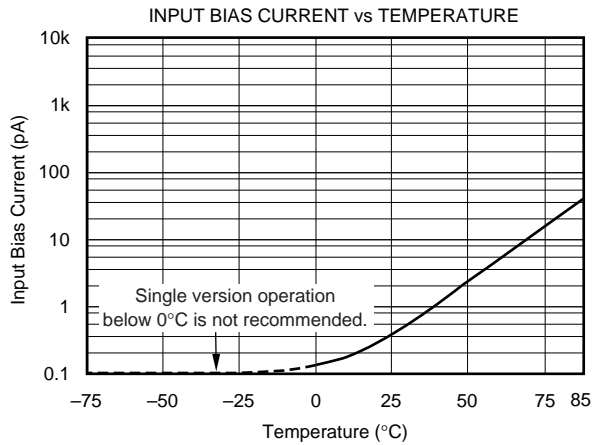
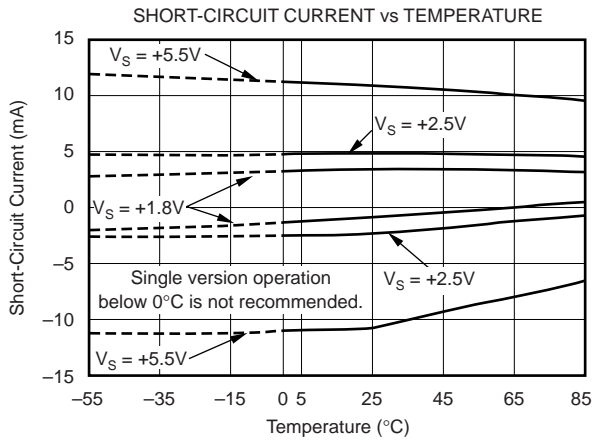
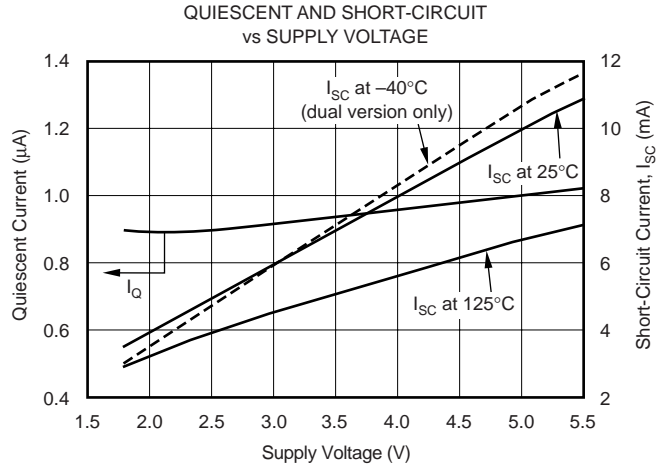
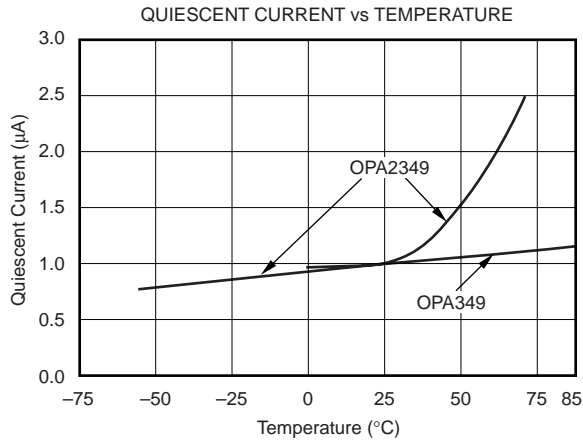

TYPICAL CHARACTERISTICS (Cont.)

At $T_A = +25^\circ\text{C}$, $V_S = +5\text{V}$, and $R_L = 1\text{M}\Omega$ connected to $V_S/2$, unless otherwise noted.

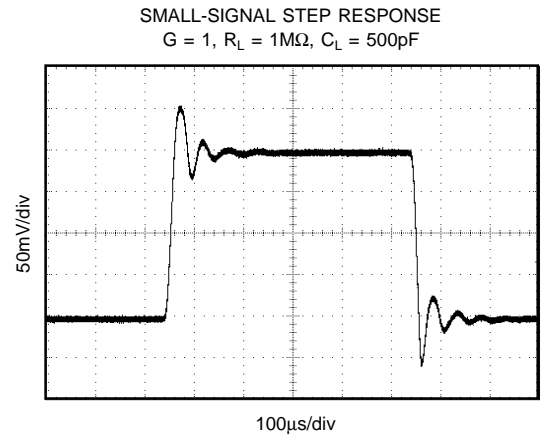
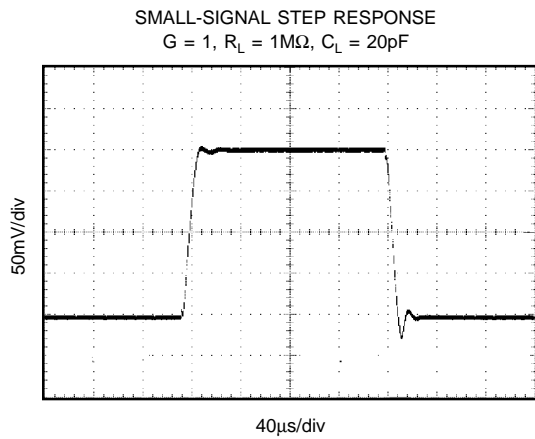
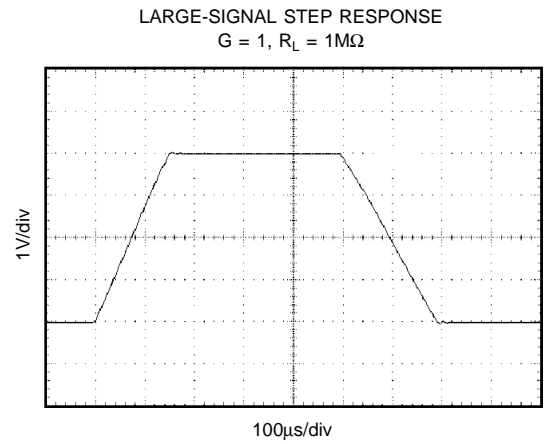
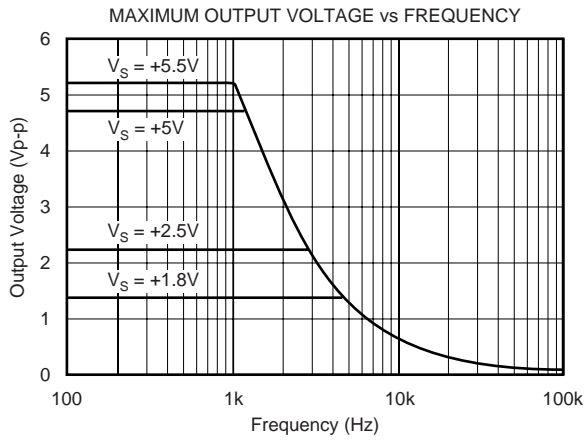
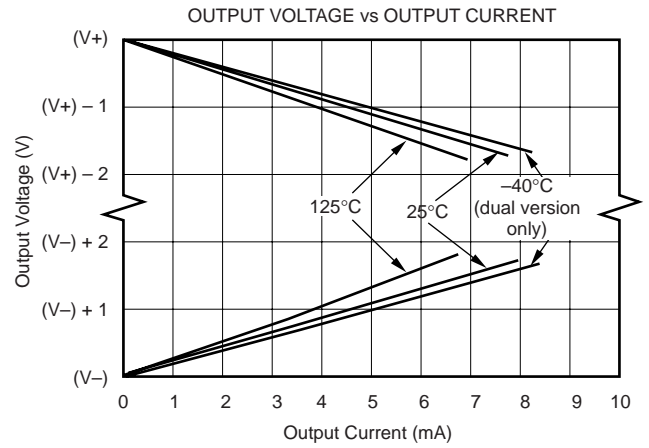
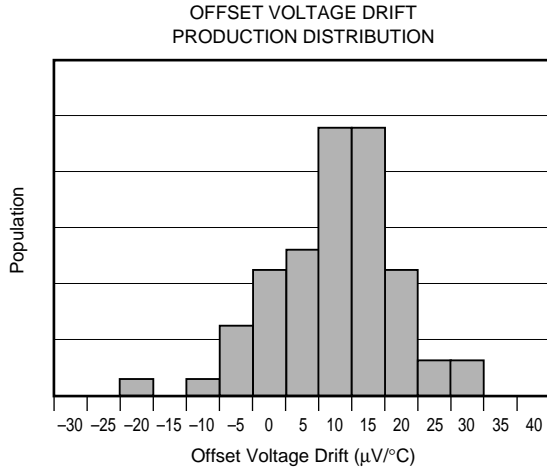

TYPICAL CHARACTERISTICS (Cont.)

At $T_A = +25^\circ\text{C}$, $V_S = +5\text{V}$, and $R_L = 1\text{M}\Omega$ connected to $V_S/2$, unless otherwise noted.

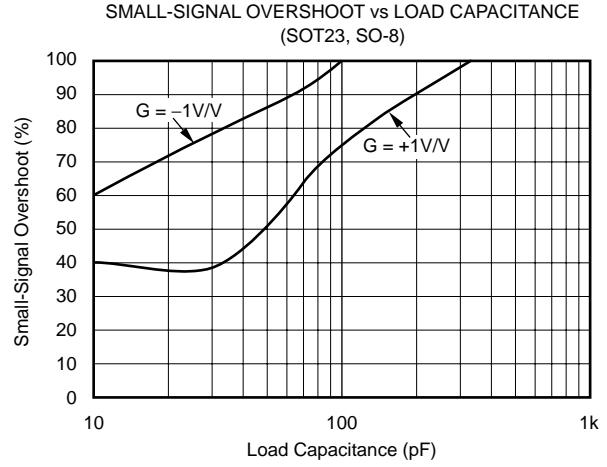
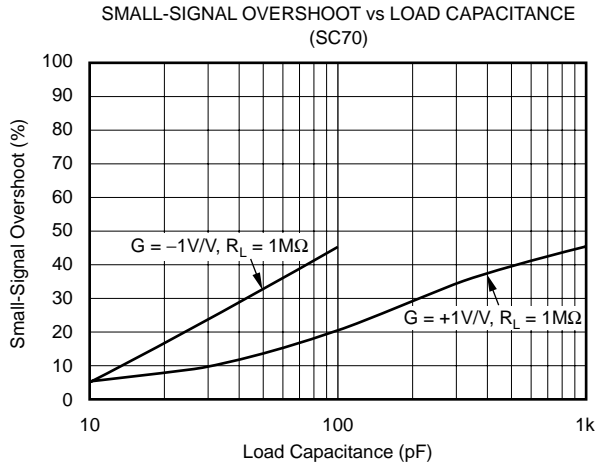

APPLICATIONS INFORMATION

The OPA349 series op amps are unity-gain stable and can operate on a single supply, making them highly versatile and easy to use. Power-supply pins should be bypassed with 0.01µF ceramic capacitors.

The OPA349 series op amps are fully specified and tested from +1.8V to +5.5V. Parameters that vary significantly with operating voltages or temperature are shown in the Typical Characteristic curves.

The ultra-low quiescent current of the OPA349 requires careful application circuit techniques to achieve low overall current consumption. Figure 1 shows an ac-coupled amplifier

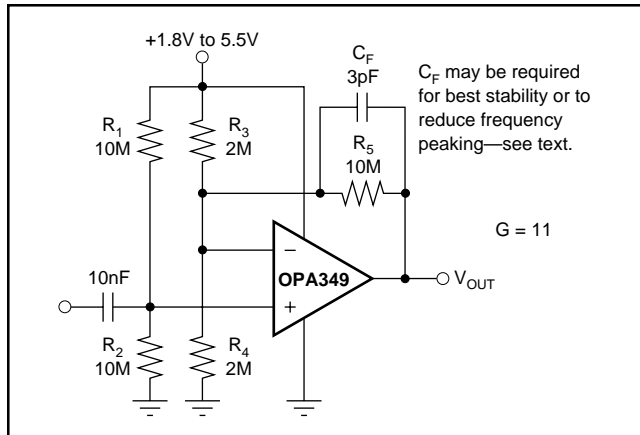

FIGURE 1. AC-Coupled Amplifier.

biased with a voltage divider. Resistor values must be very large to minimize current. The large feedback resistor value reacts with input capacitance and stray capacitance to produce a pole in the feedback network. A feedback capacitor may be required to assure stability and limit overshoot or gain peaking. Check circuit performance carefully to assure that biasing and feedback techniques meet signal and quiescent current requirements.

RAIL-TO-RAIL INPUT

The input common-mode voltage range of the OPA349 series extends 200mV beyond the supply rails. This is achieved with a complementary input stage—an N-channel input differential pair in parallel with a P-channel differential pair (as shown in Figure 2). The N-channel pair is active for input voltages close to the positive rail, typically $(V+) - 1.3V$ to 200mV above the positive supply, while the P-channel pair is on for inputs from 200mV below the negative supply to approximately $(V+) - 1.3V$. There is a small transition region, typically $(V+) - 1.5V$ to $(V+) - 1.1V$, in which both pairs are on. This 400mV transition region can vary 300mV with process variation. Thus, the transition region (both stages on) can range from $(V+) - 1.8V$ to $(V+) - 1.4V$ on the low end, up to $(V+) - 1.2V$ to $(V+) - 0.8V$ on the high end. Within the 400mV transition region PSRR, CMRR, offset voltage, offset drift, and THD may be degraded compared to operation outside this region. For more information on designing with rail-to-rail input op amps, see Figure 3, *Design Optimization with Rail-to-Rail Input Op Amps*.



FIGURE 2. Simplified Schematic.

DESIGN OPTIMIZATION WITH RAIL-TO-RAIL INPUT OP AMPS

In most applications, operation is within the range of only one differential pair. However, some applications can subject the amplifier to a common-mode signal in the transition region. Under this condition, the inherent mismatch between the two differential pairs may lead to degradation of the CMRR and THD. The unity-gain buffer configuration is the most problematic—it will traverse through the transition region if a sufficiently

wide input swing is required. A design option would be to configure the op amp as a unity-gain inverter as shown below and hold the noninverting input at a set common-mode voltage outside the transition region. This can be accomplished with a voltage divider from the supply. The voltage divider should be designed such that the biasing point for the noninverting input is outside the transition region.



FIGURE 3. Design Optimization.

COMMON-MODE REJECTION

The CMRR for the OPA349 is specified in two ways so the best match for a given application may be used. First, the CMRR of the device in the common-mode range below the transition region ($V_{CM} < (V_+) - 1.5V$) is given. This specification is the best indicator of the capability of the device when the application requires use of one of the differential input pairs. Second, the CMRR at $V_S = 5V$ over the entire common-mode range is specified.

OUTPUT DRIVEN TO V- RAIL

Loads that connect to single-supply ground (or the V- supply pin) can cause the OPA349 or OPA2349 to oscillate if the output voltage is driven into the negative rail (as shown in

Figure 4a). Similarly, loads that can cause current to flow out of the output pin when the output voltage is near V- can cause oscillations. The op amp will recover to normal operation a few microseconds after the output is driven positively out of the rail.

Some op amp applications can produce this condition even without a load connected to V-. The integrator in Figure 4b shows an example of this effect. Assume that the output ramps negatively, and saturates near 0V. Any negative-going step at V_{IN} will produce a positive output current pulse through R_1 and C_1 . This may incite the oscillation. Diode D_1 prevents the input step from pulling output current when the output is saturated at the rail, thus preventing the oscillation.

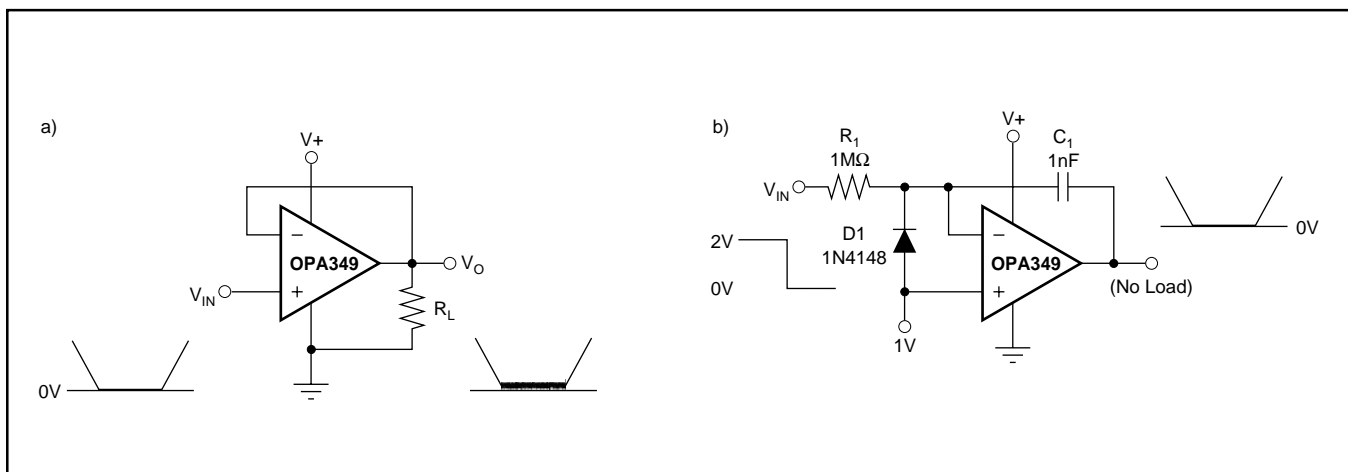

FIGURE 4. Output Driven to Negative Rail.

PACKAGING INFORMATION

Orderable Device	Status (1)	Package Type	Package Drawing	Pins	Package Qty	Eco Plan (2)	Lead finish/ Ball material (6)	MSL Peak Temp (3)	Op Temp (°C)	Device Marking (4/5)	Samples
OPA2349EA/250	ACTIVE	SOT-23	DCN	8	250	RoHS & Green	NIPDAU	Level-2-260C-1 YEAR	-55 to 125	C49	Samples
OPA2349EA/3K	ACTIVE	SOT-23	DCN	8	3000	RoHS & Green	NIPDAU	Level-2-260C-1 YEAR	-55 to 125	C49	Samples
OPA2349UA	ACTIVE	SOIC	D	8	75	RoHS & Green	NIPDAU	Level-2-260C-1 YEAR	-55 to 125	OPA 2349UA	Samples
OPA2349UA/2K5	ACTIVE	SOIC	D	8	2500	RoHS & Green	NIPDAU	Level-2-260C-1 YEAR	-55 to 125	OPA 2349UA	Samples
OPA349NA/250	ACTIVE	SOT-23	DBV	5	250	RoHS & Green	NIPDAU	Level-2-260C-1 YEAR	0 to 70	A49	Samples
OPA349NA/3K	ACTIVE	SOT-23	DBV	5	3000	RoHS & Green	NIPDAU	Level-2-260C-1 YEAR		A49	Samples
OPA349SA/250	ACTIVE	SC70	DCK	5	250	RoHS & Green	NIPDAU	Level-1-260C-UNLIM		S49	Samples
OPA349SA/3K	ACTIVE	SC70	DCK	5	3000	RoHS & Green	NIPDAU	Level-1-260C-UNLIM		S49	Samples
OPA349UA	ACTIVE	SOIC	D	8	75	RoHS & Green	NIPDAU	Level-2-260C-1 YEAR		OPA 349UA	Samples
OPA349UA/2K5	ACTIVE	SOIC	D	8	2500	RoHS & Green	NIPDAU	Level-2-260C-1 YEAR	-40 to 85	OPA 349UA	Samples

(1) The marketing status values are defined as follows:

ACTIVE: Product device recommended for new designs.

LIFEBUY: TI has announced that the device will be discontinued, and a lifetime-buy period is in effect.

NRND: Not recommended for new designs. Device is in production to support existing customers, but TI does not recommend using this part in a new design.

PREVIEW: Device has been announced but is not in production. Samples may or may not be available.

OBSELETE: TI has discontinued the production of the device.

(2) **RoHS:** TI defines "RoHS" to mean semiconductor products that are compliant with the current EU RoHS requirements for all 10 RoHS substances, including the requirement that RoHS substance do not exceed 0.1% by weight in homogeneous materials. Where designed to be soldered at high temperatures, "RoHS" products are suitable for use in specified lead-free processes. TI may reference these types of products as "Pb-Free".

RoHS Exempt: TI defines "RoHS Exempt" to mean products that contain lead but are compliant with EU RoHS pursuant to a specific EU RoHS exemption.

Green: TI defines "Green" to mean the content of Chlorine (Cl) and Bromine (Br) based flame retardants meet JS709B low halogen requirements of <=1000ppm threshold. Antimony trioxide based flame retardants must also meet the <=1000ppm threshold requirement.

(3) MSL, Peak Temp. - The Moisture Sensitivity Level rating according to the JEDEC industry standard classifications, and peak solder temperature.

- (4) There may be additional marking, which relates to the logo, the lot trace code information, or the environmental category on the device.
- (5) Multiple Device Markings will be inside parentheses. Only one Device Marking contained in parentheses and separated by a "~" will appear on a device. If a line is indented then it is a continuation of the previous line and the two combined represent the entire Device Marking for that device.
- (6) Lead finish/Ball material - Orderable Devices may have multiple material finish options. Finish options are separated by a vertical ruled line. Lead finish/Ball material values may wrap to two lines if the finish value exceeds the maximum column width.

Important Information and Disclaimer:The information provided on this page represents TI's knowledge and belief as of the date that it is provided. TI bases its knowledge and belief on information provided by third parties, and makes no representation or warranty as to the accuracy of such information. Efforts are underway to better integrate information from third parties. TI has taken and continues to take reasonable steps to provide representative and accurate information but may not have conducted destructive testing or chemical analysis on incoming materials and chemicals. TI and TI suppliers consider certain information to be proprietary, and thus CAS numbers and other limited information may not be available for release.

In no event shall TI's liability arising out of such information exceed the total purchase price of the TI part(s) at issue in this document sold by TI to Customer on an annual basis.

TAPE AND REEL INFORMATION

QUADRANT ASSIGNMENTS FOR PIN 1 ORIENTATION IN TAPE

*All dimensions are nominal

Device	Package Type	Package Drawing	Pins	SPQ	Reel Diameter (mm)	Reel Width W1 (mm)	A0 (mm)	B0 (mm)	K0 (mm)	P1 (mm)	W (mm)	Pin1 Quadrant
OPA2349EA/250	SOT-23	DCN	8	250	180.0	8.4	3.15	3.1	1.55	4.0	8.0	Q3
OPA2349EA/3K	SOT-23	DCN	8	3000	180.0	8.4	3.15	3.1	1.55	4.0	8.0	Q3
OPA2349UA/2K5	SOIC	D	8	2500	330.0	12.4	6.4	5.2	2.1	8.0	12.0	Q1
OPA349NA/250	SOT-23	DBV	5	250	178.0	8.4	3.3	3.2	1.4	4.0	8.0	Q3
OPA349NA/3K	SOT-23	DBV	5	3000	178.0	8.4	3.23	3.17	1.37	4.0	8.0	Q3
OPA349SA/250	SC70	DCK	5	250	178.0	9.0	2.4	2.5	1.2	4.0	8.0	Q3
OPA349SA/3K	SC70	DCK	5	3000	178.0	9.0	2.4	2.5	1.2	4.0	8.0	Q3
OPA349UA/2K5	SOIC	D	8	2500	330.0	12.4	6.4	5.2	2.1	8.0	12.0	Q1

TAPE AND REEL BOX DIMENSIONS



*All dimensions are nominal

Device	Package Type	Package Drawing	Pins	SPQ	Length (mm)	Width (mm)	Height (mm)
OPA2349EA/250	SOT-23	DCN	8	250	210.0	185.0	35.0
OPA2349EA/3K	SOT-23	DCN	8	3000	210.0	185.0	35.0
OPA2349UA/2K5	SOIC	D	8	2500	356.0	356.0	35.0
OPA349NA/250	SOT-23	DBV	5	250	445.0	220.0	345.0
OPA349NA/3K	SOT-23	DBV	5	3000	445.0	220.0	345.0
OPA349SA/250	SC70	DCK	5	250	180.0	180.0	18.0
OPA349SA/3K	SC70	DCK	5	3000	180.0	180.0	18.0
OPA349UA/2K5	SOIC	D	8	2500	356.0	356.0	35.0

TUBE

*All dimensions are nominal

Device	Package Name	Package Type	Pins	SPQ	L (mm)	W (mm)	T (μm)	B (mm)
OPA2349UA	D	SOIC	8	75	506.6	8	3940	4.32
OPA349UA	D	SOIC	8	75	506.6	8	3940	4.32

DCN (R-PDSO-G8)

PLASTIC SMALL-OUTLINE PACKAGE (DIE DOWN)

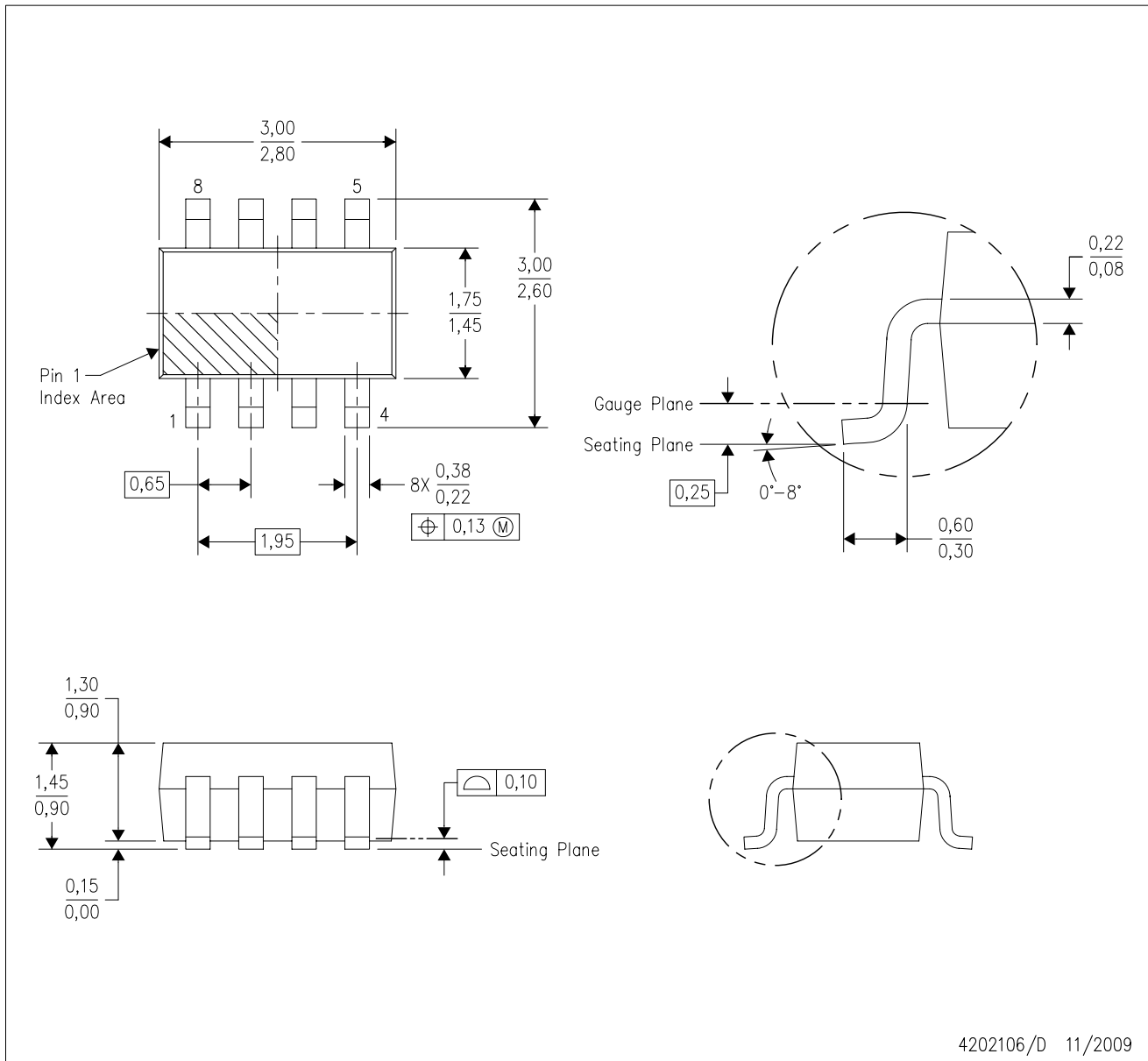

4202106/D 11/2009

- NOTES:
- A. All linear dimensions are in millimeters.
 - B. This drawing is subject to change without notice.
 - C. Package outline exclusive of metal burr & dambar protrusion/intrusion.
 - D. Package outline inclusive of solder plating.
 - E. A visual index feature must be located within the Pin 1 index area.
 - F. Falls within JEDEC MO-178 Variation BA.
 - G. Body dimensions do not include flash or protrusion. Mold flash and protrusion shall not exceed 0.25 per side.

DCN (R-PDSO-G8)

PLASTIC SMALL-OUTLINE PACKAGE (DIE DOWN)



- NOTES:
- A. All linear dimensions are in millimeters.
 - B. This drawing is subject to change without notice.
 - C. Publication IPC-7351 is recommended for alternate designs.
 - D. Laser cutting apertures with trapezoidal walls and also rounding corners will offer better paste release. Customers should contact their board assembly site for stencil design recommendations. Refer to IPC-7525.
 - E. Customers should contact their board fabrication site for solder mask tolerances between and around signal pads.

DBV0005A



PACKAGE OUTLINE

SOT-23 - 1.45 mm max height

SMALL OUTLINE TRANSISTOR



NOTES:

1. All linear dimensions are in millimeters. Any dimensions in parenthesis are for reference only. Dimensioning and tolerancing per ASME Y14.5M.
2. This drawing is subject to change without notice.
3. Reference JEDEC MO-178.
4. Body dimensions do not include mold flash, protrusions, or gate burrs. Mold flash, protrusions, or gate burrs shall not exceed 0.25 mm per side.
5. Support pin may differ or may not be present.

4214839/H 09/2023

EXAMPLE BOARD LAYOUT

DBV0005A

SOT-23 - 1.45 mm max height

SMALL OUTLINE TRANSISTOR



LAND PATTERN EXAMPLE
EXPOSED METAL SHOWN
SCALE:15X

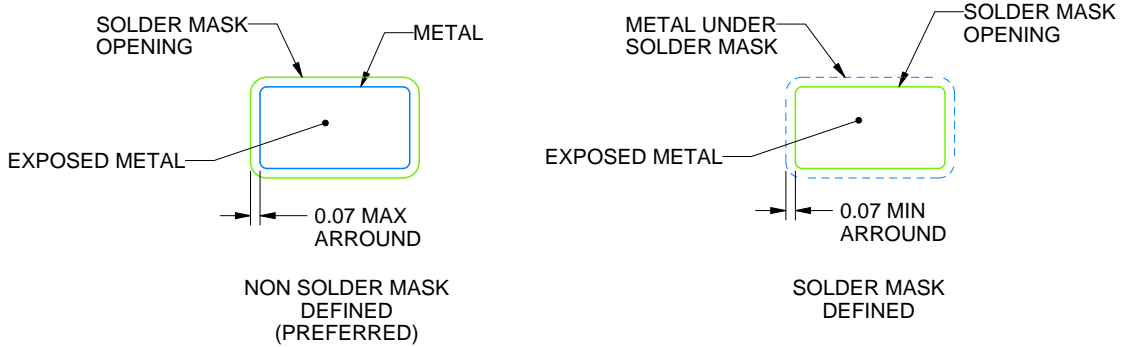

SOLDER MASK DETAILS

4214839/H 09/2023

NOTES: (continued)

6. Publication IPC-7351 may have alternate designs.

7. Solder mask tolerances between and around signal pads can vary based on board fabrication site.

EXAMPLE STENCIL DESIGN

DBV0005A

SOT-23 - 1.45 mm max height

SMALL OUTLINE TRANSISTOR



SOLDER PASTE EXAMPLE
BASED ON 0.125 mm THICK STENCIL
SCALE:15X

4214839/H 09/2023

NOTES: (continued)

8. Laser cutting apertures with trapezoidal walls and rounded corners may offer better paste release. IPC-7525 may have alternate design recommendations.
9. Board assembly site may have different recommendations for stencil design.



D0008A

PACKAGE OUTLINE

SOIC - 1.75 mm max height

SMALL OUTLINE INTEGRATED CIRCUIT



4214825/C 02/2019

NOTES:

1. Linear dimensions are in inches [millimeters]. Dimensions in parenthesis are for reference only. Controlling dimensions are in inches. Dimensioning and tolerancing per ASME Y14.5M.
2. This drawing is subject to change without notice.
3. This dimension does not include mold flash, protrusions, or gate burrs. Mold flash, protrusions, or gate burrs shall not exceed .006 [0.15] per side.
4. This dimension does not include interlead flash.
5. Reference JEDEC registration MS-012, variation AA.



EXAMPLE BOARD LAYOUT

D0008A

SOIC - 1.75 mm max height

SMALL OUTLINE INTEGRATED CIRCUIT



LAND PATTERN EXAMPLE
EXPOSED METAL SHOWN
SCALE:8X



SOLDER MASK DETAILS

4214825/C 02/2019

NOTES: (continued)

6. Publication IPC-7351 may have alternate designs.

7. Solder mask tolerances between and around signal pads can vary based on board fabrication site.

EXAMPLE STENCIL DESIGN

D0008A

SOIC - 1.75 mm max height

SMALL OUTLINE INTEGRATED CIRCUIT



SOLDER PASTE EXAMPLE
BASED ON .005 INCH [0.125 MM] THICK STENCIL
SCALE:8X

4214825/C 02/2019

NOTES: (continued)

8. Laser cutting apertures with trapezoidal walls and rounded corners may offer better paste release. IPC-7525 may have alternate design recommendations.
9. Board assembly site may have different recommendations for stencil design.

DCK0005A



PACKAGE OUTLINE

SOT - 1.1 max height

SMALL OUTLINE TRANSISTOR



4214834/C 03/2023

NOTES:

1. All linear dimensions are in millimeters. Any dimensions in parenthesis are for reference only. Dimensioning and tolerancing per ASME Y14.5M.
2. This drawing is subject to change without notice.
3. Reference JEDEC MO-203.
4. Support pin may differ or may not be present.

EXAMPLE BOARD LAYOUT

DCK0005A

SOT - 1.1 max height

SMALL OUTLINE TRANSISTOR

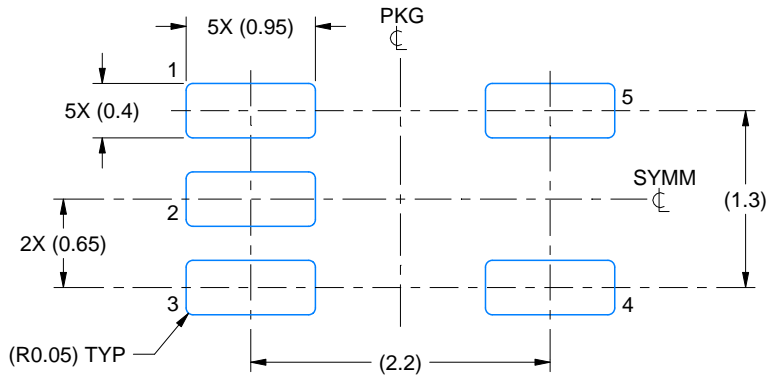

LAND PATTERN EXAMPLE
EXPOSED METAL SHOWN
SCALE:18X



SOLDER MASK DETAILS

4214834/C 03/2023

NOTES: (continued)

- 4. Publication IPC-7351 may have alternate designs.
- 5. Solder mask tolerances between and around signal pads can vary based on board fabrication site.

EXAMPLE STENCIL DESIGN

DCK0005A

SOT - 1.1 max height

SMALL OUTLINE TRANSISTOR



SOLDER PASTE EXAMPLE
BASED ON 0.125 THICK STENCIL
SCALE:18X

4214834/C 03/2023

NOTES: (continued)

6. Laser cutting apertures with trapezoidal walls and rounded corners may offer better paste release. IPC-7525 may have alternate design recommendations.
7. Board assembly site may have different recommendations for stencil design.

IMPORTANT NOTICE AND DISCLAIMER

TI PROVIDES TECHNICAL AND RELIABILITY DATA (INCLUDING DATA SHEETS), DESIGN RESOURCES (INCLUDING REFERENCE DESIGNS), APPLICATION OR OTHER DESIGN ADVICE, WEB TOOLS, SAFETY INFORMATION, AND OTHER RESOURCES "AS IS" AND WITH ALL FAULTS, AND DISCLAIMS ALL WARRANTIES, EXPRESS AND IMPLIED, INCLUDING WITHOUT LIMITATION ANY IMPLIED WARRANTIES OF MERCHANTABILITY, FITNESS FOR A PARTICULAR PURPOSE OR NON-INFRINGEMENT OF THIRD PARTY INTELLECTUAL PROPERTY RIGHTS.

These resources are intended for skilled developers designing with TI products. You are solely responsible for (1) selecting the appropriate TI products for your application, (2) designing, validating and testing your application, and (3) ensuring your application meets applicable standards, and any other safety, security, regulatory or other requirements.

These resources are subject to change without notice. TI grants you permission to use these resources only for development of an application that uses the TI products described in the resource. Other reproduction and display of these resources is prohibited. No license is granted to any other TI intellectual property right or to any third party intellectual property right. TI disclaims responsibility for, and you will fully indemnify TI and its representatives against, any claims, damages, costs, losses, and liabilities arising out of your use of these resources.

TI's products are provided subject to [TI's Terms of Sale](#) or other applicable terms available either on [ti.com](https://www.ti.com) or provided in conjunction with such TI products. TI's provision of these resources does not expand or otherwise alter TI's applicable warranties or warranty disclaimers for TI products.

TI objects to and rejects any additional or different terms you may have proposed.

Mailing Address: Texas Instruments, Post Office Box 655303, Dallas, Texas 75265
Copyright © 2023, Texas Instruments Incorporated

单击下面可查看定价，库存，交付和生命周期等信息

[>>TI\(德州仪器\)](#)