

## TPS723 200-mA, Low-Noise, High-PSRR, Negative Output Low-Dropout Linear Regulators

### 1 Features

- Ultralow noise: 60  $\mu\text{V}_{\text{RMS}}$  typical
- High PSRR: 65 dB typical at 1 kHz
- Low dropout voltage: 280 mV typical at 200 mA, 2.5 V
- Available in  $-2.5\text{-V}$  and adjustable ( $-1.2\text{ V}$  to  $-10\text{ V}$ ) versions
- Stable with a 2.2- $\mu\text{F}$  ceramic output capacitor
- Less than 2- $\mu\text{A}$  typical quiescent current in shutdown mode
- 2% overall accuracy (line, load, temperature)
- Thermal and over-current protection
- Packages:
  - SOT23-5 (DBV)
  - SOT23-5 (DDC)
  - WSON-6 (DRV)
- Operating junction temperature range:  $-40^{\circ}\text{C}$  to  $125^{\circ}\text{C}$

### 2 Applications

- [Optical modules](#)
- [Semiconductor manufacturing](#)
- [Medical accessories](#)
- [Oscilloscopes](#)
- [Active antenna system mMIMO \(AAS\)](#)

### 3 Description

The TPS723 low-dropout (LDO) negative voltage regulator offers an ideal combination of features to support low noise applications. This device is capable of operating with input voltages from  $-10\text{ V}$  to  $-2.7\text{ V}$ , and support outputs from  $-10\text{ V}$  to  $-1.2\text{ V}$ . This regulator is stable with small, low-cost ceramic capacitors, and include enable (EN) and noise reduction (NR) functions. Thermal short-circuit and over-current protections are provided by internal detection and shutdown logic. High PSRR (65 dB at 1 kHz) and low noise (60  $\mu\text{V}_{\text{RMS}}$ ) make the TPS723 ideal for low-noise applications.

The TPS723 uses a precision voltage reference to achieve 2% overall accuracy over load, line, and temperature variations. Available in a small SOT23-5 package, the TPS723 is fully specified over a temperature range of  $-40^{\circ}\text{C}$  to  $125^{\circ}\text{C}$ .

#### Device Information<sup>(1)</sup>

PART NUMBER	PACKAGE <sup>(2)</sup>	BODY SIZE (NOM)
TPS723	SOT-23 (5)	2.90 mm x 1.60 mm
	SOT (5)	2.90 mm x 1.60 mm
	WSON (6)	2.00 mm x 2.00 mm

(1) For all available packages, see the orderable addendum at the end of the data sheet.

(2) The two SOT23 packages are identical in size, but the SOT package is thinner.

#### Typical Application Circuit

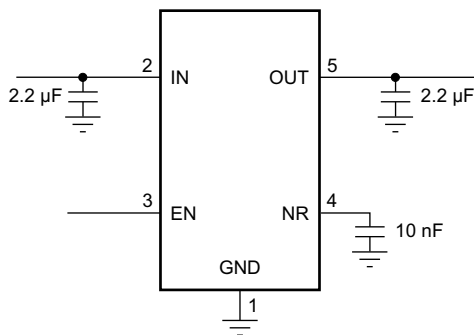

## Table of Contents

<b>1 Features</b> ..... 1 <b>2 Applications</b> ..... 1 <b>3 Description</b> ..... 1 <b>4 Revision History</b> ..... 2 <b>5 Pin Configuration and Functions</b> ..... 3 <b>6 Specifications</b> ..... 4 6.1 Absolute Maximum Ratings ..... 4 6.2 ESD Ratings ..... 4 6.3 Recommended Operating Conditions ..... 4 6.4 Thermal Information ..... 4 6.5 Electrical Characteristics ..... 5 6.6 Typical Characteristics ..... 6 <b>7 Detailed Description</b> ..... 11 7.1 Overview ..... 11 7.2 Functional Block Diagrams ..... 11 7.3 Feature Description ..... 12 7.4 Device Functional Modes ..... 12	<b>8 Application and Implementation</b> ..... 13 8.1 Application Information ..... 13 8.2 Typical Application ..... 13 8.3 What to Do and What Not to Do ..... 14 <b>9 Power Supply Recommendations</b> ..... 15 <b>10 Layout</b> ..... 15 10.1 Layout Guidelines ..... 15 10.2 Layout Example ..... 15 <b>11 Device and Documentation Support</b> ..... 16 11.1 Device Support ..... 16 11.2 Receiving Notification of Documentation Updates ..... 16 11.3 Support Resources ..... 16 11.4 Trademarks ..... 16 11.5 Electrostatic Discharge Caution ..... 16 11.6 Glossary ..... 16 <b>12 Mechanical, Packaging, and Orderable Information</b> ..... 16
--	---

## 4 Revision History

Changes from Revision C (September 2014) to Revision D	Page
• Added DRV package to document .....	1
• Changed <i>Applications</i> section to link to end equipment .....	1

Changes from Revision B (July 2007) to Revision C	Page
• Changed format to meet latest data sheet standards; added new sections, and moved existing sections .....	1
• Added bullet item for DDC package to Features list .....	1
• Revised <i>Device Information</i> table to include SOT-5 package .....	1
• Updated <i>Typical Application Circuit</i> to show SOT-5 (DDC) package pin configuration .....	1
• Added pin configuration drawings .....	3
• Deleted <i>Dissipation Ratings</i> table; see <a href="#">Thermal Information</a> .....	4
• Changed y-axis title in <a href="#">Figure 11</a> to <i>Feedback Current</i> from <i>Supply Current</i> .....	6
• Reworded second paragraph in <a href="#">Current Limit</a> subsection. ....	12

Changes from Revision A (June 2007) to Revision B	Page
• Added second paragraph in <a href="#">Current Limit</a> subsection .....	12
• Changed equation shown in <a href="#">Figure 27</a> .....	13

Changes from Original (September 2003) to Revision A	Page
• Changed document format to correspond to current product line standards .....	1
• Removed <i>Output Voltage vs Output Current</i> graph (original Fig 2) .....	6

## 5 Pin Configuration and Functions

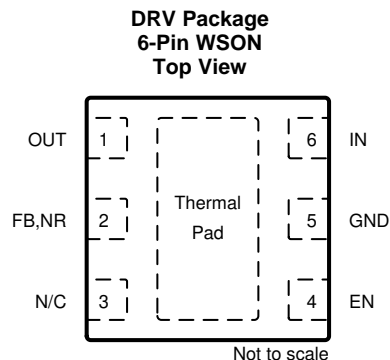
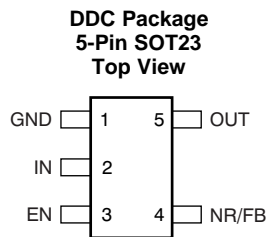
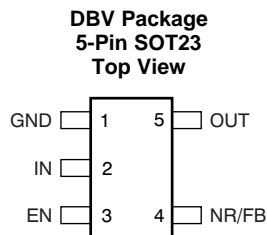

### Pin Functions

NAME	PIN		I/O	DESCRIPTION
	NO.			
	DBV, DDC	DRV		
GND	1	5	—	Ground
IN	2	6	I	Input supply
EN	3	4	I	Bipolar enable pin. Driving this pin above the positive enable threshold or below the negative enable threshold turns on the regulator. Driving this pin below the positive disable threshold and above the negative disable threshold puts the regulator into shutdown mode.
NR	4	2	—	Fixed voltage versions only. Connecting an external capacitor between this pin and ground, bypasses noise generated by the internal band gap. This configuration allows output noise to be reduced to very low levels.
FB	4	2	I	Adjustable voltage version only. This pin is the input to the control loop error amplifier. This pin is used to set the output voltage of the device.
OUT	5	1	O	Regulated output voltage. A small, 2.2- $\mu$ F ceramic capacitor is needed from this pin to GND to ensure stability.
N/C	—	3		No internal connection

## 6 Specifications

### 6.1 Absolute Maximum Ratings

over operating junction temperature range (unless otherwise noted)<sup>(1)(2)</sup>

		MIN	MAX	UNIT
Voltage	IN	-11	+0.3	V
	NR	-11	+5.5	
	EN	-V <sub>I</sub>	+5.5	
	OUT	-11	+0.3	
Current	OUT	Internally limited		A
Output short-circuit duration		Indefinite		
Continuous total power dissipation		See <a href="#">Thermal Information table</a>		
Operating junction temperature, T <sub>J</sub>		-65	150	°C
Storage temperature, T <sub>stg</sub>		-65	150	°C

- Stresses beyond those listed under *Absolute Maximum Ratings* may cause permanent damage to the device. These are stress ratings only, which do not imply functional operation of the device at these or any other conditions beyond those indicated under *Recommended Operating Conditions*. Exposure to absolute-maximum-rated conditions for extended periods may affect device reliability.
- All voltage values are with respect to network ground terminal.

### 6.2 ESD Ratings

			VALUE	UNIT
V <sub>(ESD)</sub>	Electrostatic discharge	Human-body model (HBM), per ANSI/ESDA/JEDEC JS-001 <sup>(1)</sup>	±1000	V
		Charged-device model (CDM), per JEDEC specification JESD22-C101 <sup>(2)</sup>	±500	

- JEDEC document JEP155 states that 500-V HBM allows safe manufacturing with a standard ESD control process.
- JEDEC document JEP157 states that 250-V CDM allows safe manufacturing with a standard ESD control process.

### 6.3 Recommended Operating Conditions

over operating junction temperature range (unless otherwise noted)

		MIN	NOM	MAX	UNIT
V <sub>I</sub>	Input supply voltage range	-10		-2.7	V
I <sub>O</sub>	Output current	0		200	mA
T <sub>J</sub>	Operating junction temperature	-40		125	°C

### 6.4 Thermal Information

THERMAL METRIC <sup>(1)</sup>		TPS723			UNIT
		DBV (SOT23)	DDC (SOT23)	DRV (WSON)	
		5 PINS	5 PINS	6 PINS	
R <sub>θJA</sub>	Junction-to-ambient thermal resistance	206.9	194.8	85.6	°C/W
R <sub>θJC(top)</sub>	Junction-to-case (top) thermal resistance	120.5	41.4	83.7	°C/W
R <sub>θJB</sub>	Junction-to-board thermal resistance	35.9	35.9	47.3	°C/W
ψ <sub>JT</sub>	Junction-to-top characterization parameter	13.3	1.0	3.7	°C/W
ψ <sub>JB</sub>	Junction-to-board characterization parameter	35.0	35.7	47.3	°C/W
R <sub>θJC(bot)</sub>	Junction-to-case (bottom) thermal resistance	N/A	N/A	31.6	°C/W

- For more information about traditional and new thermal metrics, see the [Semiconductor and IC package thermal metrics application report](#).

## 6.5 Electrical Characteristics

Over operating junction temperature range,  $V_I = V_{O(NOM)} - 0.5\text{ V}$ ,  $I_O = 1\text{ mA}$ ,  $V_{EN} = 1.5\text{ V}$ ,  $C_O = 2.2\text{ }\mu\text{F}$ , and  $C_{NR} = 0.01\text{ }\mu\text{F}$ , unless otherwise noted. Typical values are at  $T_J = 25^\circ\text{C}$ .

PARAMETER			TEST CONDITIONS	MIN	TYP	MAX	UNIT
$V_I$	Input voltage range <sup>(1)</sup>			-10		-2.7	V
$V_{FB}$	Feedback reference voltage	TPS72301	$T_J = 25^\circ\text{C}$	-1.210	-1.186	-1.162	V
$V_O$	Output voltage range	TPS72301		$-10 + V_{DO}$		$V_{FB}$	V
	Accuracy	Nominal	$T_J = 25^\circ\text{C}$	-1%		1%	
		TPS72325 vs $V_I/I_O/T$	$-10\text{ V} \leq V_I \leq V_O - 0.5\text{ V}$ , $10\text{ }\mu\text{A} \leq I_O \leq 200\text{ mA}$	-2%	$\pm 1\%$	2%	
TPS72301 vs $V_I/I_O/T$	-3%	$\pm 1$		3%			
$\Delta V_{O(\Delta V_I)}$	Line regulation		$-10\text{ V} \leq V_I \leq V_{O(NOM)} - 0.5\text{ V}$		0.04		%/V
$\Delta V_{O(\Delta I_O)}$	Load regulation		$0\text{ mA} \leq I_O \leq 200\text{ mA}$		0.002		%/mA
$V_{DO}$	Dropout voltage at $V_O = 0.96 \times V_{O(NOM)}$	TPS72325	$I_O = 200\text{ mA}$		280	500	mV
$I_{(LIM)}$	Current limit		$V_O = 0.85 \times V_{O(NOM)}$	300	550	800	mA
$I_{(GND)}$	Ground pin current		$I_O = 0\text{ mA}$ ( $I_Q$ ), $-10\text{ V} \leq V_I \leq V_O - 0.5\text{ V}$		130	200	$\mu\text{A}$
			$I_O = 200\text{ mA}$ , $-10\text{ V} \leq V_I \leq V_O - 0.5\text{ V}$		350	500	
$I_{(SHDN)}$	Shutdown ground pin current		$-0.4\text{ V} \leq V_{EN} \leq 0.4\text{ V}$ , $-10\text{ V} \leq V_I \leq V_O - 0.5\text{ V}$		0.1	2.0	$\mu\text{A}$
$I_{(FB)}$	Feedback pin current		$-10\text{ V} \leq V_I \leq V_O - 0.5\text{ V}$		0.05	1.0	$\mu\text{A}$
PSRR	Power-supply rejection ratio		$I_O = 200\text{ mA}$ , 1 kHz, $C_I = C_O = 10\text{ }\mu\text{F}$		65		dB
			$I_O = 200\text{ mA}$ , 10 kHz, $C_I = C_O = 10\text{ }\mu\text{F}$		48		
$V_n$	Output noise voltage	TPS72325	$C_O = 10\text{ }\mu\text{F}$ , 10 Hz to 100 kHz, $I_O = 200\text{ mA}$		60		$\mu\text{V}_{RMS}$
$t_{STR}$	Startup time		$V_O = -2.5\text{ V}$ , $C_O = 1\text{ }\mu\text{F}$ , $R_L = 25\text{ }\Omega$		1		ms
$V_{EN(HI)}$	Enable threshold positive			1.5			V
$V_{EN(LO)}$	Enable threshold negative					-1.5	V
$V_{DIS(HI)}$	Disable threshold positive					0.4	V
$V_{DIS(LO)}$	Disable threshold negative			-0.4			V
$I_{(EN)}$	Enable pin current		$-10\text{ V} \leq V_I \leq V_O - 0.5\text{ V}$ , $-10\text{ V} \leq V_{EN} \leq \pm 3.5\text{ V}$		0.1	2.0	$\mu\text{A}$
$T_{sd}$	Thermal shutdown temperature		Shutdown, temperature increasing		165		$^\circ\text{C}$
			Reset, temperature decreasing		145		
$T_J$	Operating junction temperature			-40		125	$^\circ\text{C}$

(1) Maximum  $V_I = (V_O - V_{DO})$  or  $-2.7\text{ V}$ , whichever is more negative.

### 6.6 Typical Characteristics

TPS72325 at  $V_I = V_{O(NOM)} - 0.5\text{ V}$ ,  $I_O = 1\text{ mA}$ ,  $V_{EN} = 1.5\text{ V}$ ,  $C_O = 2.2\text{ }\mu\text{F}$ , and  $C_{NR} = 0.01\text{ }\mu\text{F}$ , unless otherwise noted.

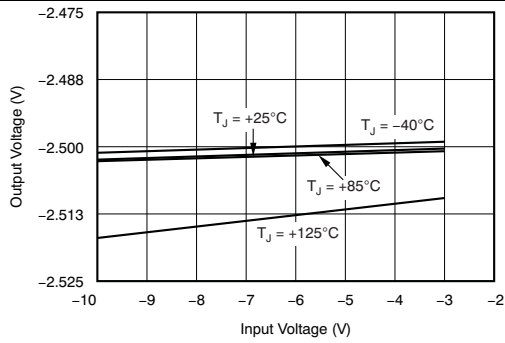

Figure 1. Output Voltage vs Input Voltage

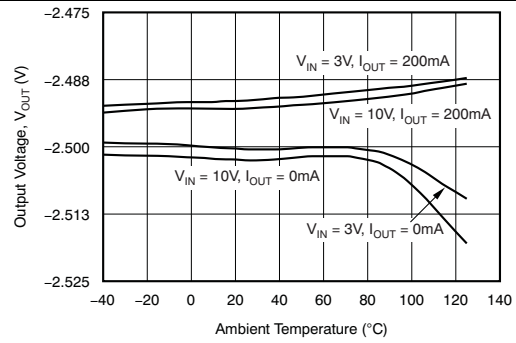

Figure 2. Output Voltage vs Ambient Temperature

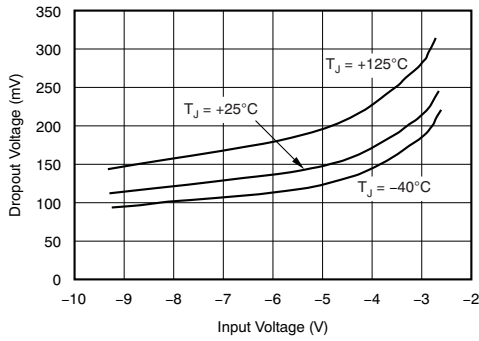

Figure 3. TPS72301 Dropout Voltage vs Input Voltage

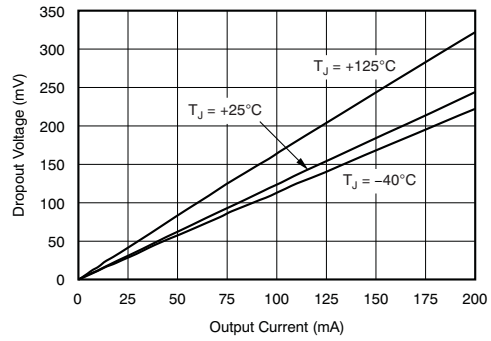

Figure 4. Dropout Voltage vs Output Current

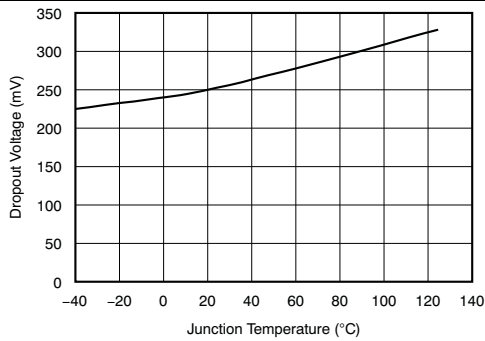

Figure 5. TPS72325 Dropout Voltage vs Junction Temperature

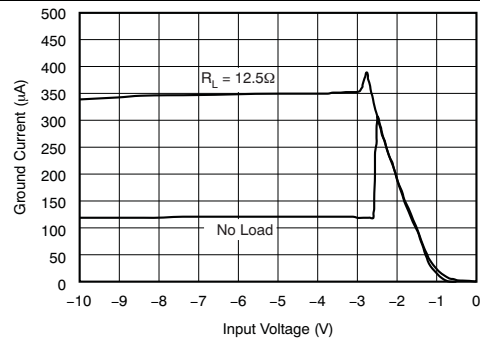

Figure 6. Ground Current vs Input Voltage

Typical Characteristics (continued)

TPS72325 at  $V_I = V_{O(NOM)} - 0.5\text{ V}$ ,  $I_O = 1\text{ mA}$ ,  $V_{EN} = 1.5\text{ V}$ ,  $C_O = 2.2\text{ }\mu\text{F}$ , and  $C_{NR} = 0.01\text{ }\mu\text{F}$ , unless otherwise noted.

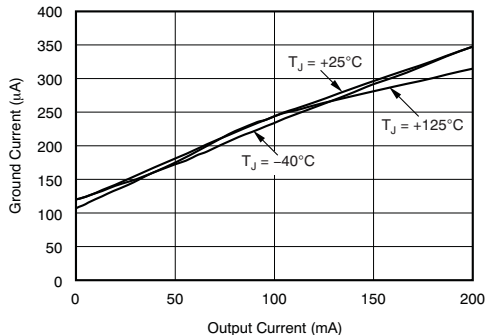

Figure 7. Ground Current vs Output Current

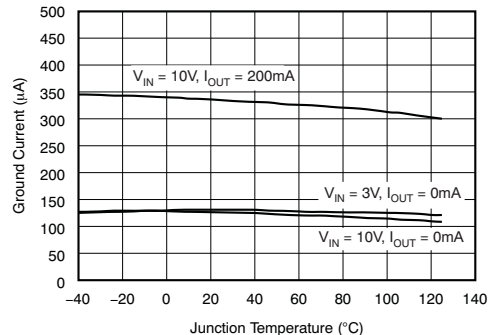

Figure 8. Ground Current vs Junction Temperature

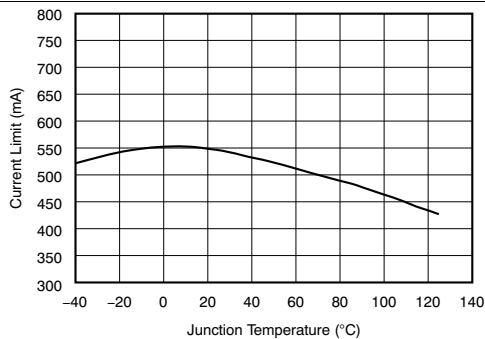

Figure 9. TPS72325 Current Limit vs Junction Temperature

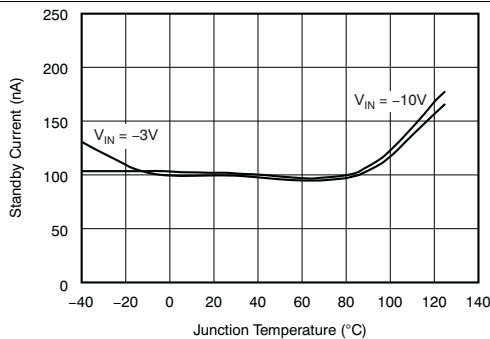

Figure 10. Standby Current vs Junction Temperature

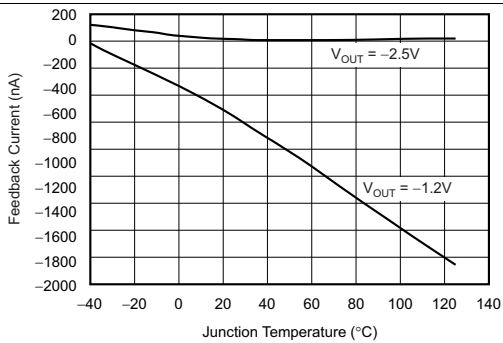

Figure 11. TPS72301 Feedback Pin Current vs Junction Temperature

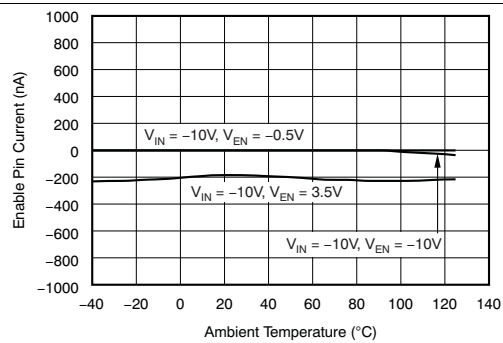

Figure 12. Enable Pin Current vs Junction Temperature

Typical Characteristics (continued)

TPS72325 at  $V_I = V_{O(NOM)} - 0.5\text{ V}$ ,  $I_O = 1\text{ mA}$ ,  $V_{EN} = 1.5\text{ V}$ ,  $C_O = 2.2\text{ }\mu\text{F}$ , and  $C_{NR} = 0.01\text{ }\mu\text{F}$ , unless otherwise noted.

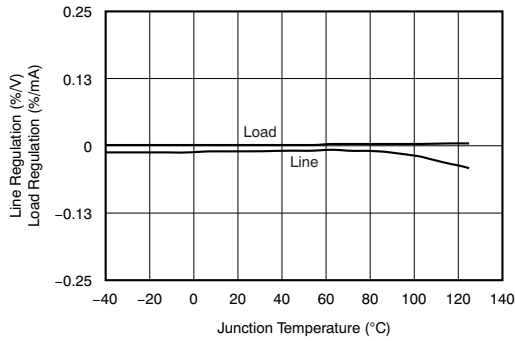

Figure 13. Line And Load Regulation vs Junction Temperature

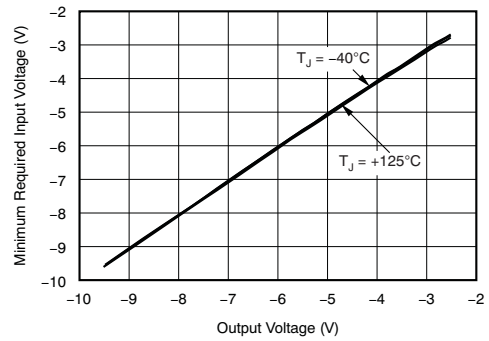

Figure 14. TPS72301 Minimum Required Input Voltage vs Output Voltage

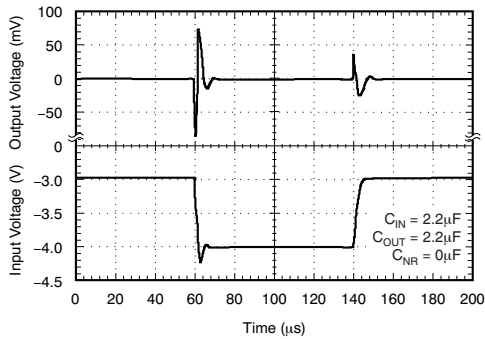

Figure 15. TPS72325 Line Transient Response

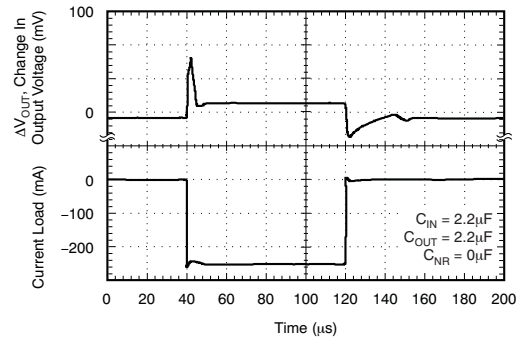

Figure 16. TPS72325 Load Transient Response

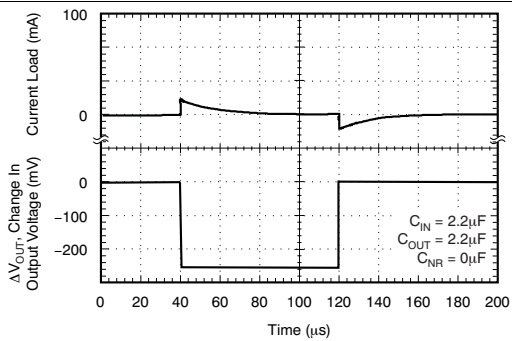

Figure 17. TPS72325 Load Transient Response

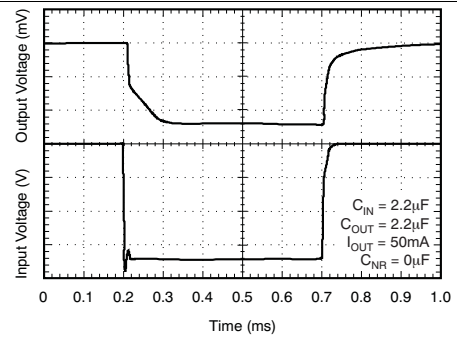

Figure 18. TPS72325 Start-Up Response



Typical Characteristics (continued)

TPS72325 at  $V_I = V_{O(NOM)} - 0.5\text{ V}$ ,  $I_O = 1\text{ mA}$ ,  $V_{EN} = 1.5\text{ V}$ ,  $C_O = 2.2\text{ }\mu\text{F}$ , and  $C_{NR} = 0.01\text{ }\mu\text{F}$ , unless otherwise noted.

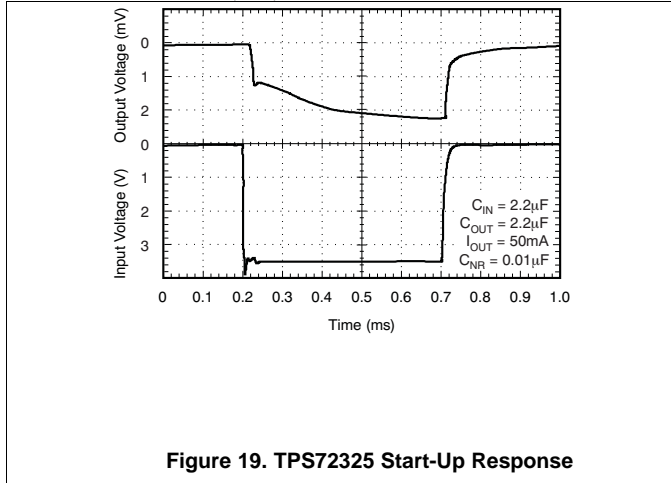

Figure 19. TPS72325 Start-Up Response

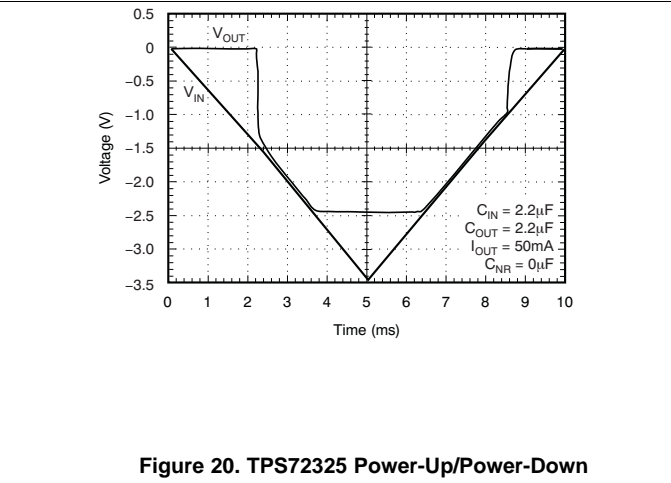

Figure 20. TPS72325 Power-Up/Power-Down

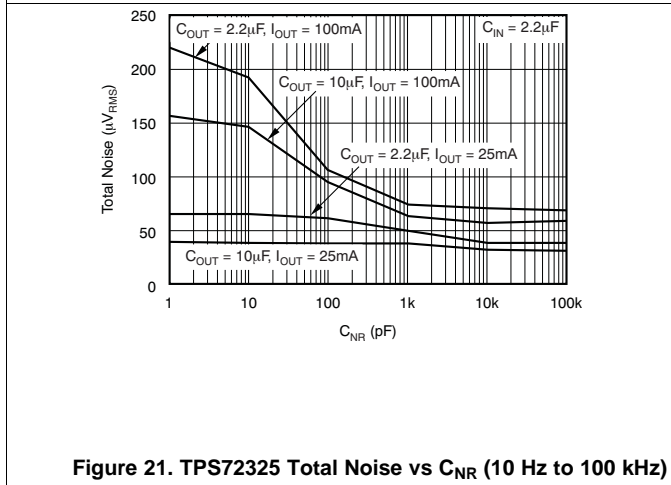

Figure 21. TPS72325 Total Noise vs  $C_{NR}$  (10 Hz to 100 kHz)

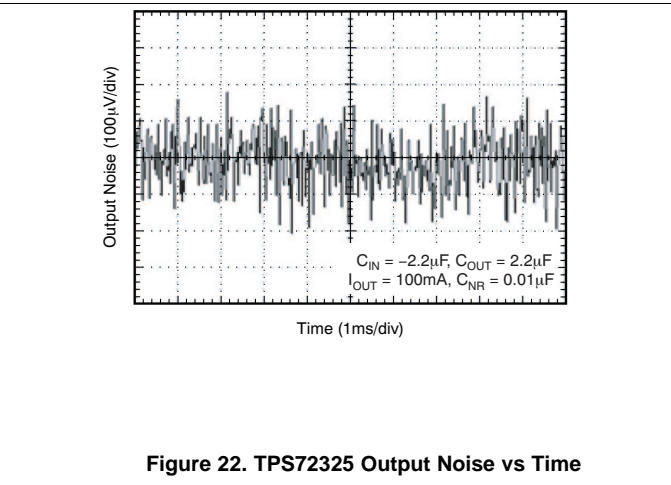

Figure 22. TPS72325 Output Noise vs Time

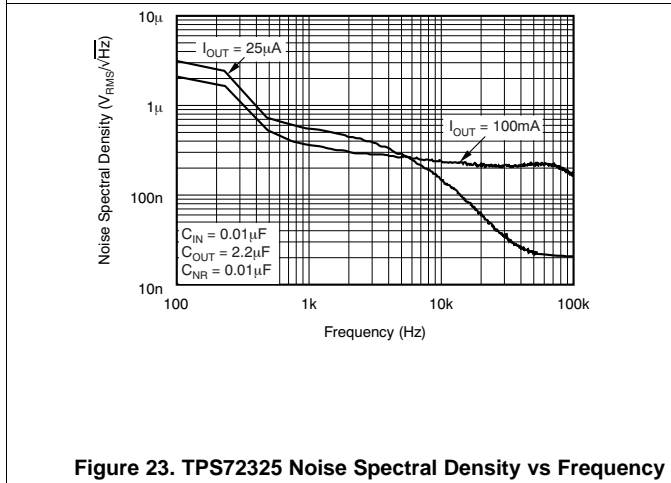

Figure 23. TPS72325 Noise Spectral Density vs Frequency

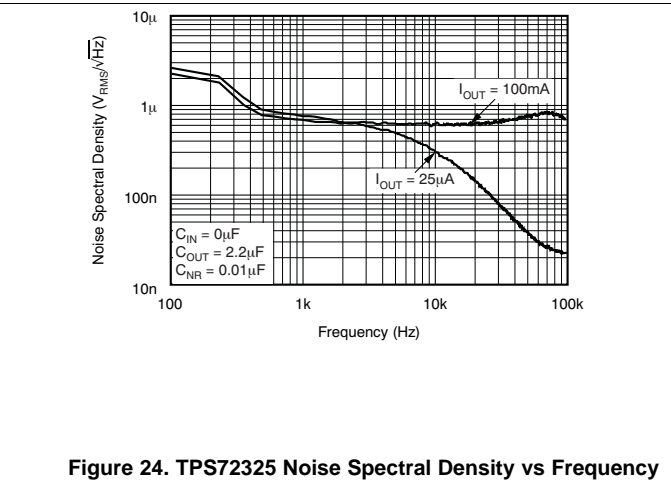

Figure 24. TPS72325 Noise Spectral Density vs Frequency

### Typical Characteristics (continued)

TPS72325 at  $V_I = V_{O(NOM)} - 0.5\text{ V}$ ,  $I_O = 1\text{ mA}$ ,  $V_{EN} = 1.5\text{ V}$ ,  $C_O = 2.2\text{ }\mu\text{F}$ , and  $C_{NR} = 0.01\text{ }\mu\text{F}$ , unless otherwise noted.

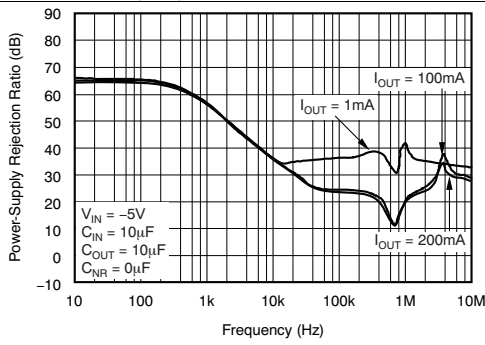

Figure 25. PSRR vs Frequency

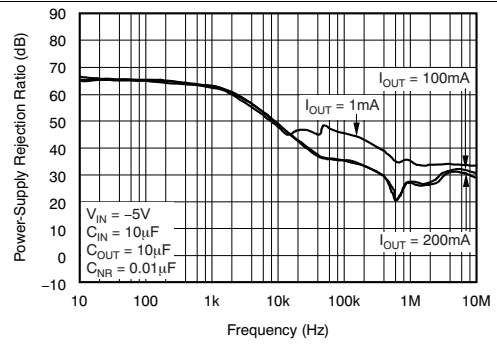

Figure 26. PSRR vs Frequency

## 7 Detailed Description

### 7.1 Overview

The TPS723 is a low-dropout, negative linear voltage regulator with a rated current of 200 mA. It is offered in trimmed output voltages between  $-1.5$  V and  $-5.2$  V and as an adjustable regulator from  $-1.2$  V to  $-10$  V. The device features very low noise and high power-supply rejection ratio (PSRR), making the TPS723 ideal for high-sensitivity analog and RF applications. A shutdown mode is available, reducing ground current to  $2\text{-}\mu\text{A}$  maximum over temperature and process.

### 7.2 Functional Block Diagrams

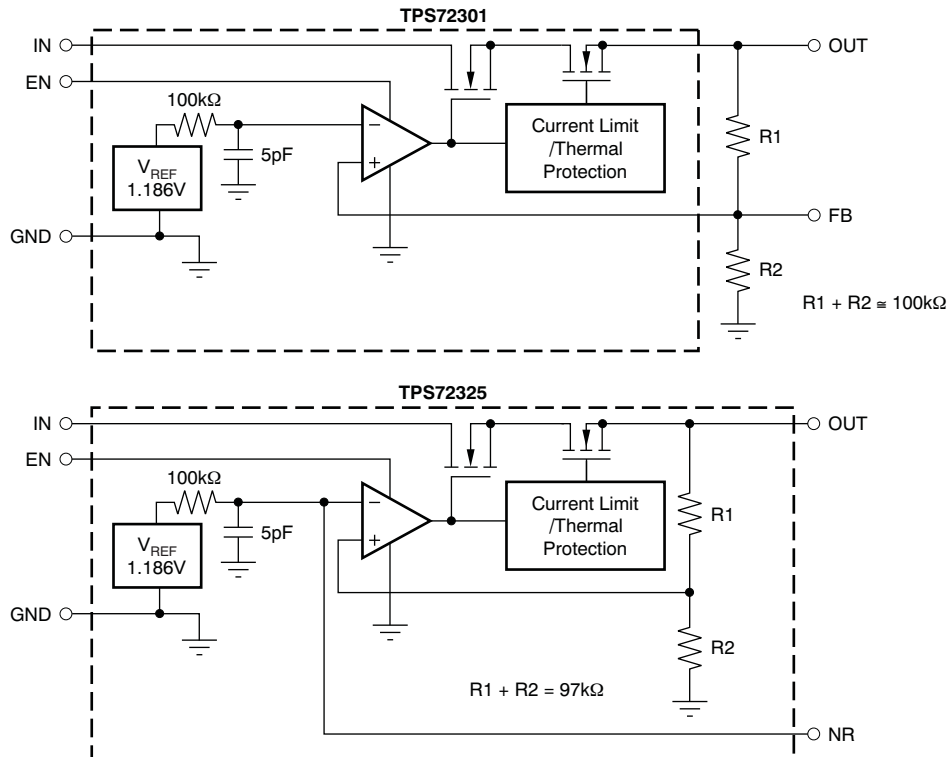

## 7.3 Feature Description

### 7.3.1 Current Limit

The TPS723 has internal circuitry that monitors and limits output current to protect the regulator from damage under all load conditions. When output current reaches the output current limit (550 mA typical), protection circuitry turns on, reducing output voltage to ensure that current does not increase. See [Figure 9](#) in the [Typical Characteristics](#) section.

Do not drive the output more than 0.3 V above the input. An output voltage more than 0.3 V above the input voltage biases the body diode in the pass FET, and allows current to flow from the output to the input. This current is not limited by the device. If this condition is expected, make sure to externally limit the reverse current.

### 7.3.2 Enable

The enable pin is active above +1.5 V and below –1.5 V, allowing it to be controlled by a standard TTL signal or by connection to  $V_I$  if not used. When driven to GND most internal circuitry is turned off, putting the TPS723 into shutdown mode, drawing 2- $\mu$ A maximum ground current.

## 7.4 Device Functional Modes

Driving EN over 1.5 V or below –1.5 V turns on the regulator. Driving EN between –1.5 V and +1.5 V puts the regulator into shutdown mode, thus reducing the operating current to 100 nA, nominal.

## 8 Application and Implementation

### NOTE

Information in the following applications sections is not part of the TI component specification, and TI does not warrant its accuracy or completeness. TI's customers are responsible for determining suitability of components for their purposes. Customers should validate and test their design implementation to confirm system functionality.

### 8.1 Application Information

The TPS723 LDO regulator provides high PSRR and low noise. These features make the device a good fit for high-sensitivity analog and RF applications.

### 8.2 Typical Application

The TPS72301 allows designers to specify any output voltage from  $-10\text{ V}$  to  $-1.2\text{ V}$ . As shown in the application circuit in [Figure 27](#), an external resistor divider is used to scale the output voltage ( $V_O$ ) to the reference voltage. For best accuracy, use precision resistors for R1 and R2. Use the equations in [Figure 27](#) to determine the values for the resistor divider.

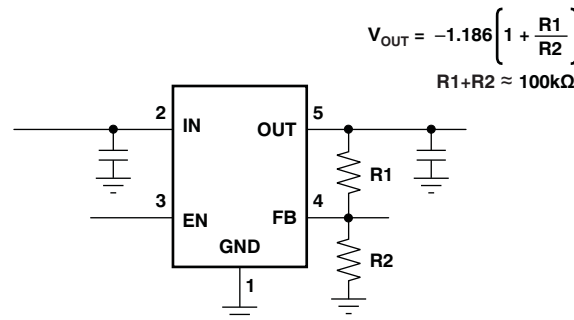

Figure 27. TPS72301 Adjustable LDO Regulator Programming

#### 8.2.1 Design Requirements

##### 8.2.1.1 Capacitor Selection for Stability

Appropriate input and output capacitors should be used for the intended application. The TPS723 only requires a  $2.2\text{-}\mu\text{F}$  ceramic output capacitor to be used for stable operation. Both the capacitor value and equivalent series resistance (ESR) affect stability, output noise, PSRR, and transient response. For typical applications, a  $2.2\text{-}\mu\text{F}$  ceramic output capacitor located close to the regulator is sufficient.

##### 8.2.1.2 Output Noise

Without external bypassing, output noise of the TPS723 from  $10\text{ Hz}$  to  $100\text{ kHz}$  is  $200\text{ }\mu\text{V}_{\text{RMS}}$  typical. The dominant contributor to output noise is the internal bandgap reference. Adding an external  $0.01\text{-}\mu\text{F}$  capacitor to ground reduces noise to  $60\text{ }\mu\text{V}_{\text{RMS}}$ . Best noise performance is achieved using appropriate low ESR capacitors for bypassing noise at the IN and OUT pins. See [Figure 21](#) in the *Typical Characteristics* section.

##### 8.2.1.3 Power-Supply Rejection

The TPS723 offers a very high PSRR for applications with noisy input sources or highly sensitive output supply lines. For best PSRR, use high-quality input and output capacitors.

#### 8.2.2 Detailed Design Procedure

Select the desired device based on the output voltage.

Provide an input supply with adequate headroom to account for dropout and output current to account for the GND terminal current, and power the load.

## Typical Application (continued)

### 8.2.3 Application Curves

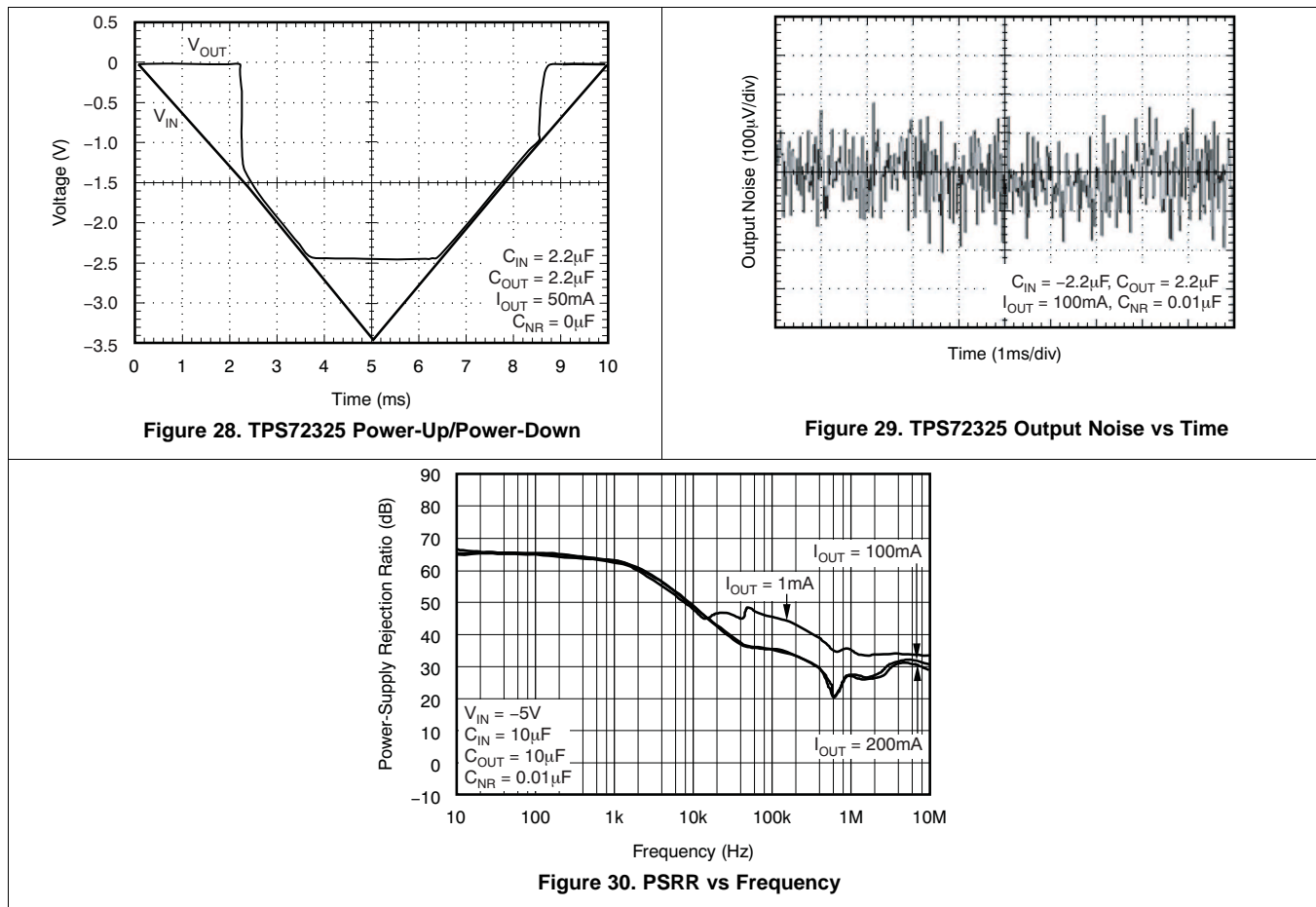

### 8.3 What to Do and What Not to Do

- Do place at least one 2.2- $\mu F$  ceramic capacitor as close as possible to the OUT terminal of the regulator.
- Do not place the output capacitor more than 10 mm away from the regulator.
- Do connect a 0.1- $\mu F$  to 2.2- $\mu F$  low ESR capacitor across the IN terminal and GND input of the regulator.
- Do not exceed the absolute maximum ratings.

## 9 Power Supply Recommendations

These devices are designed to operate from an input voltage supply range between  $-10\text{ V}$  and  $-2.7\text{ V}$ . The input voltage range must provide adequate headroom in order for the device to have a regulated output. This input supply must be well-regulated and stable. If the input supply is noisy, additional input capacitors with low ESR can help improve the output noise performance.

## 10 Layout

### 10.1 Layout Guidelines

To improve ac performance (such as PSRR, output noise, and transient response), design the board with separate ground planes for  $V_I$  and  $V_O$ , with each ground plane connected only at the GND pin of the device. In addition, connect the bypass capacitor directly to the GND pin of the device.

#### 10.1.1 Power Dissipation

The ability to remove heat from the die is different for each package type, presenting different considerations in the printed circuit board (PCB) layout. The PCB area around the device that is free of other components moves the heat from the device to the ambient air. Performance data for JEDEC low- and high-K boards are given in the [Thermal Information](#) table near the front of this data sheet. Using heavier copper increases the effectiveness in removing heat from the device. The addition of plated through-holes to heat-dissipating layers also improves heatsink effectiveness. Power dissipation depends on input voltage and load conditions. Power dissipation is equal to the product of the output current times the voltage drop across the output pass element, as shown in [Equation 1](#):

$$P_D = (V_{IN} - V_{OUT}) \cdot I_{OUT} \quad (1)$$

#### 10.1.2 Thermal Protection

As protection from damage due to excessive junction temperatures, the TPS723 has internal protection circuitry. When junction temperature reaches approximately  $165^\circ\text{C}$ , the output device is turned off. After the device has cooled to  $145^\circ\text{C}$ , the output device is enabled, allowing normal operation. For reliable operation, design is for worst-case junction temperature of  $\leq 125^\circ\text{C}$  taking into account worst-case ambient temperature and load conditions.

### 10.2 Layout Example

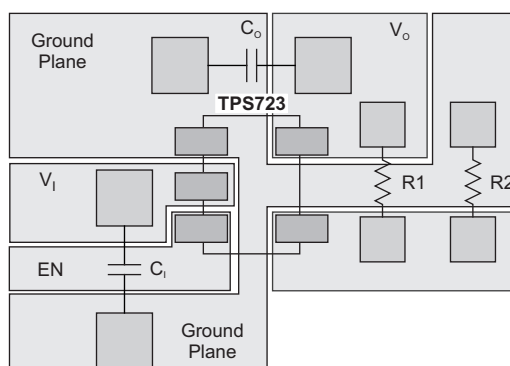

**Figure 31. Example Layout**

## 11 Device and Documentation Support

### 11.1 Device Support

#### 11.1.1 Development Support

##### 11.1.1.1 Spice Models

Computer simulation of circuit performance using SPICE is often useful when analyzing the performance of analog circuits and systems. A SPICE model for the TPS723xx is available through the product folders under *Simulation Models*.

#### 11.1.2 Device Nomenclature

**Table 1. Device Nomenclature<sup>(1)</sup>**

PRODUCT	V <sub>OUT</sub>
TPS723xx yyy z	<b>XX</b> is nominal output voltage (for example, 25 = 2.5 V, 01 = Adjustable). <b>YYY</b> is package designator. <b>Z</b> is package quantity.

(1) For the most current package and ordering information see the Package Option Addendum at the end of this document, or visit the device product folder at [www.ti.com](http://www.ti.com).

### 11.2 Receiving Notification of Documentation Updates

To receive notification of documentation updates, navigate to the device product folder on ti.com. In the upper right corner, click on *Alert me* to register and receive a weekly digest of any product information that has changed. For change details, review the revision history included in any revised document.

### 11.3 Support Resources

**TI E2E™ support forums** are an engineer's go-to source for fast, verified answers and design help — straight from the experts. Search existing answers or ask your own question to get the quick design help you need.

Linked content is provided "AS IS" by the respective contributors. They do not constitute TI specifications and do not necessarily reflect TI's views; see TI's [Terms of Use](#).

### 11.4 Trademarks

E2E is a trademark of Texas Instruments.

All other trademarks are the property of their respective owners.

### 11.5 Electrostatic Discharge Caution



This integrated circuit can be damaged by ESD. Texas Instruments recommends that all integrated circuits be handled with appropriate precautions. Failure to observe proper handling and installation procedures can cause damage.

ESD damage can range from subtle performance degradation to complete device failure. Precision integrated circuits may be more susceptible to damage because very small parametric changes could cause the device not to meet its published specifications.

### 11.6 Glossary

**SLYZ022** — *TI Glossary*.

This glossary lists and explains terms, acronyms, and definitions.

## 12 Mechanical, Packaging, and Orderable Information

The following pages include mechanical, packaging, and orderable information. This information is the most current data available for the designated devices. This data is subject to change without notice and revision of this document. For browser-based versions of this data sheet, refer to the left-hand navigation.



**PACKAGING INFORMATION**

Orderable Device	Status (1)	Package Type	Package Drawing	Pins	Package Qty	Eco Plan (2)	Lead finish/ Ball material (6)	MSL Peak Temp (3)	Op Temp (°C)	Device Marking (4/5)	Samples
TPS72301DBVR	ACTIVE	SOT-23	DBV	5	3000	RoHS & Green	NIPDAU	Level-1-260C-UNLIM	-40 to 125	T08I	<a href="#">Samples</a>
TPS72301DBVRG4	ACTIVE	SOT-23	DBV	5	3000	RoHS & Green	NIPDAU	Level-1-260C-UNLIM	-40 to 125	T08I	<a href="#">Samples</a>
TPS72301DBVT	LIFEBUY	SOT-23	DBV	5	250	RoHS & Green	NIPDAU	Level-1-260C-UNLIM	-40 to 125	T08I	
TPS72301DBVTG4	LIFEBUY	SOT-23	DBV	5	250	RoHS & Green	NIPDAU	Level-1-260C-UNLIM	-40 to 125	T08I	
TPS72301DDCR	LIFEBUY	SOT-23-THIN	DDC	5	3000	RoHS & Green	NIPDAU	Level-2-260C-1 YEAR	-40 to 125	T08I	
TPS72301DDCT	ACTIVE	SOT-23-THIN	DDC	5	250	RoHS & Green	NIPDAU	Level-2-260C-1 YEAR	-40 to 125	T08I	<a href="#">Samples</a>
TPS72301DRVR	ACTIVE	WSON	DRV	6	3000	RoHS & Green	NIPDAU	Level-1-260C-UNLIM	-40 to 125	1TLM	<a href="#">Samples</a>
TPS72301DRVT	ACTIVE	WSON	DRV	6	250	RoHS & Green	NIPDAU	Level-1-260C-UNLIM	-40 to 125	1TLM	<a href="#">Samples</a>
TPS72325DBVR	ACTIVE	SOT-23	DBV	5	3000	RoHS & Green	NIPDAU	Level-1-260C-UNLIM	-40 to 125	T02I	<a href="#">Samples</a>
TPS72325DBVRG4	ACTIVE	SOT-23	DBV	5	3000	RoHS & Green	NIPDAU	Level-1-260C-UNLIM	-40 to 125	T02I	<a href="#">Samples</a>
TPS72325DBVT	LIFEBUY	SOT-23	DBV	5	250	RoHS & Green	NIPDAU	Level-1-260C-UNLIM	-40 to 125	T02I	
TPS72325DBVTG4	LIFEBUY	SOT-23	DBV	5	250	RoHS & Green	NIPDAU	Level-1-260C-UNLIM	-40 to 125	T02I	

(1) The marketing status values are defined as follows:

**ACTIVE:** Product device recommended for new designs.

**LIFEBUY:** TI has announced that the device will be discontinued, and a lifetime-buy period is in effect.

**NRND:** Not recommended for new designs. Device is in production to support existing customers, but TI does not recommend using this part in a new design.

**PREVIEW:** Device has been announced but is not in production. Samples may or may not be available.

**OBSELETE:** TI has discontinued the production of the device.

(2) **RoHS:** TI defines "RoHS" to mean semiconductor products that are compliant with the current EU RoHS requirements for all 10 RoHS substances, including the requirement that RoHS substance do not exceed 0.1% by weight in homogeneous materials. Where designed to be soldered at high temperatures, "RoHS" products are suitable for use in specified lead-free processes. TI may reference these types of products as "Pb-Free".

**RoHS Exempt:** TI defines "RoHS Exempt" to mean products that contain lead but are compliant with EU RoHS pursuant to a specific EU RoHS exemption.

**Green:** TI defines "Green" to mean the content of Chlorine (Cl) and Bromine (Br) based flame retardants meet JS709B low halogen requirements of <=1000ppm threshold. Antimony trioxide based flame retardants must also meet the <=1000ppm threshold requirement.

(3) MSL, Peak Temp. - The Moisture Sensitivity Level rating according to the JEDEC industry standard classifications, and peak solder temperature.

- (4) There may be additional marking, which relates to the logo, the lot trace code information, or the environmental category on the device.
- (5) Multiple Device Markings will be inside parentheses. Only one Device Marking contained in parentheses and separated by a "~" will appear on a device. If a line is indented then it is a continuation of the previous line and the two combined represent the entire Device Marking for that device.
- (6) Lead finish/Ball material - Orderable Devices may have multiple material finish options. Finish options are separated by a vertical ruled line. Lead finish/Ball material values may wrap to two lines if the finish value exceeds the maximum column width.

**Important Information and Disclaimer:**The information provided on this page represents TI's knowledge and belief as of the date that it is provided. TI bases its knowledge and belief on information provided by third parties, and makes no representation or warranty as to the accuracy of such information. Efforts are underway to better integrate information from third parties. TI has taken and continues to take reasonable steps to provide representative and accurate information but may not have conducted destructive testing or chemical analysis on incoming materials and chemicals. TI and TI suppliers consider certain information to be proprietary, and thus CAS numbers and other limited information may not be available for release.

In no event shall TI's liability arising out of such information exceed the total purchase price of the TI part(s) at issue in this document sold by TI to Customer on an annual basis.

**OTHER QUALIFIED VERSIONS OF TPS723 :**

- Automotive : [TPS723-Q1](#)

NOTE: Qualified Version Definitions:

- Automotive - Q100 devices qualified for high-reliability automotive applications targeting zero defects

**TAPE AND REEL INFORMATION**

**QUADRANT ASSIGNMENTS FOR PIN 1 ORIENTATION IN TAPE**

\*All dimensions are nominal

Device	Package Type	Package Drawing	Pins	SPQ	Reel Diameter (mm)	Reel Width W1 (mm)	A0 (mm)	B0 (mm)	K0 (mm)	P1 (mm)	W (mm)	Pin1 Quadrant
TPS72301DBVR	SOT-23	DBV	5	3000	180.0	8.4	3.2	3.2	1.4	4.0	8.0	Q3
TPS72301DBVT	SOT-23	DBV	5	250	180.0	8.4	3.2	3.2	1.4	4.0	8.0	Q3
TPS72301DDCR	SOT-23-THIN	DDC	5	3000	179.0	8.4	3.2	3.2	1.4	4.0	8.0	Q3
TPS72301DDCT	SOT-23-THIN	DDC	5	250	180.0	8.4	3.2	3.2	1.4	4.0	8.0	Q3
TPS72301DRVR	WSON	DRV	6	3000	178.0	8.4	2.25	2.25	1.0	4.0	8.0	Q2
TPS72301DRVT	WSON	DRV	6	250	178.0	8.4	2.25	2.25	1.0	4.0	8.0	Q2
TPS72325DBVR	SOT-23	DBV	5	3000	179.0	8.4	3.2	3.2	1.4	4.0	8.0	Q3
TPS72325DBVT	SOT-23	DBV	5	250	180.0	8.4	3.2	3.2	1.4	4.0	8.0	Q3

**TAPE AND REEL BOX DIMENSIONS**

\*All dimensions are nominal

Device	Package Type	Package Drawing	Pins	SPQ	Length (mm)	Width (mm)	Height (mm)
TPS72301DBVR	SOT-23	DBV	5	3000	200.0	183.0	25.0
TPS72301DBVT	SOT-23	DBV	5	250	200.0	183.0	25.0
TPS72301DDCR	SOT-23-THIN	DDC	5	3000	213.0	191.0	35.0
TPS72301DDCT	SOT-23-THIN	DDC	5	250	213.0	191.0	35.0
TPS72301DRVR	WSON	DRV	6	3000	205.0	200.0	33.0
TPS72301DRVT	WSON	DRV	6	250	205.0	200.0	33.0
TPS72325DBVR	SOT-23	DBV	5	3000	200.0	183.0	25.0
TPS72325DBVT	SOT-23	DBV	5	250	200.0	183.0	25.0

# DDC0005A



## PACKAGE OUTLINE

### SOT-23 - 1.1 max height

SMALL OUTLINE TRANSISTOR

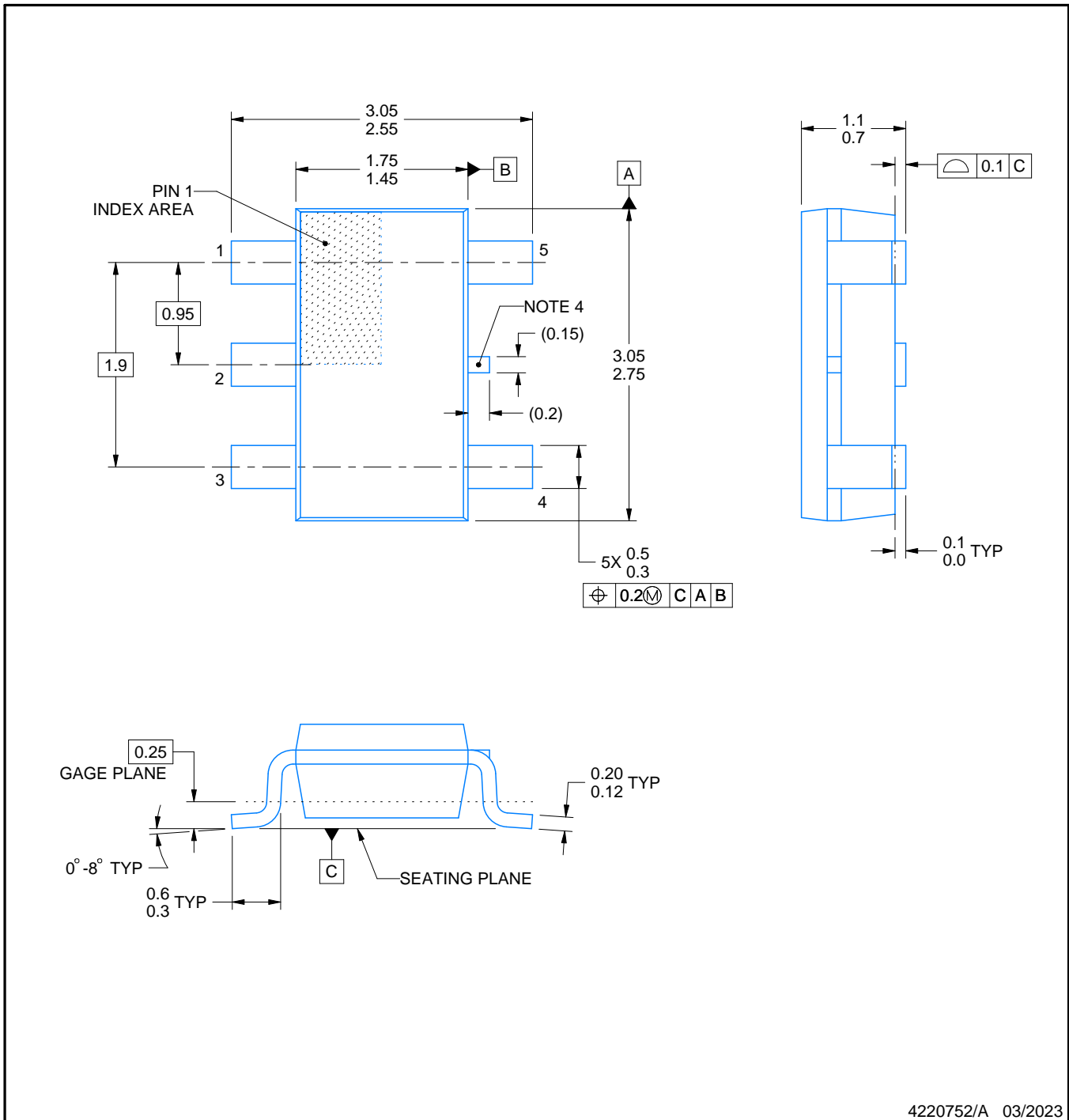

4220752/A 03/2023

#### NOTES:

- All linear dimensions are in millimeters. Any dimensions in parenthesis are for reference only. Dimensioning and tolerancing per ASME Y14.5M.
- This drawing is subject to change without notice.
- Reference JEDEC MO-193.
- Support pin may differ or may not be present.

# EXAMPLE BOARD LAYOUT

DDC0005A

SOT-23 - 1.1 max height

SMALL OUTLINE TRANSISTOR

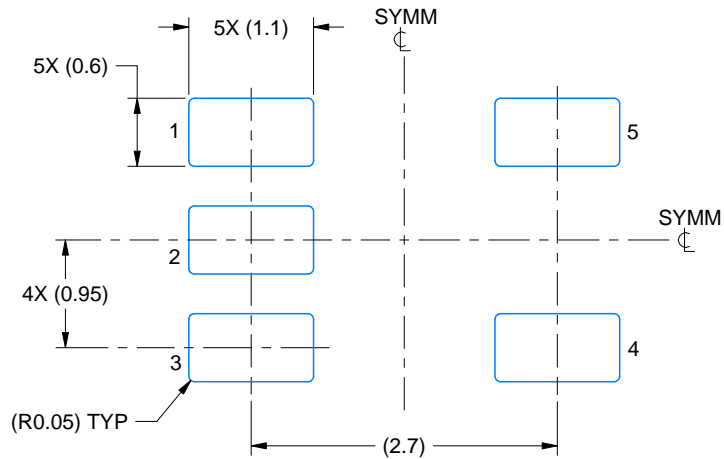

LAND PATTERN EXAMPLE  
EXPLODED METAL SHOWN  
SCALE:15X

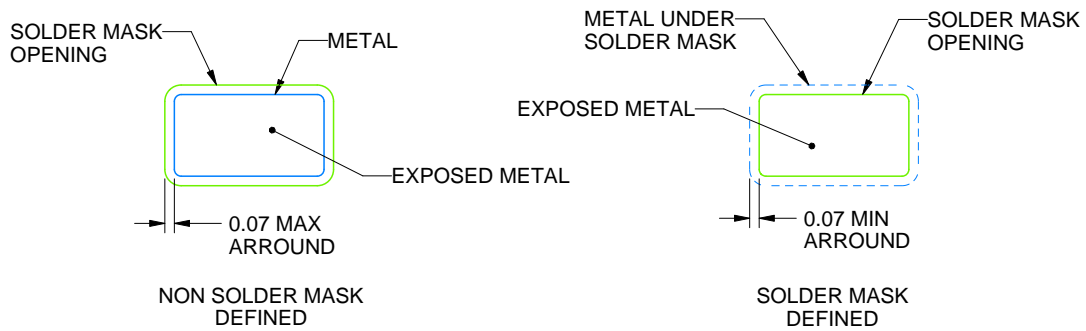

SOLDERMASK DETAILS

4220752/A 03/2023

NOTES: (continued)

- 4. Publication IPC-7351 may have alternate designs.
- 5. Solder mask tolerances between and around signal pads can vary based on board fabrication site.

# EXAMPLE STENCIL DESIGN

DDC0005A

SOT-23 - 1.1 max height

SMALL OUTLINE TRANSISTOR

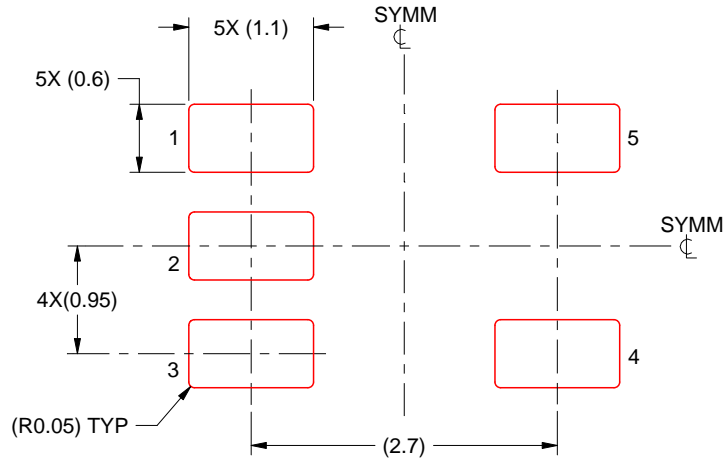

SOLDER PASTE EXAMPLE  
BASED ON 0.125 THICK STENCIL  
SCALE:15X

4220752/A 03/2023

NOTES: (continued)

6. Laser cutting apertures with trapezoidal walls and rounded corners may offer better paste release. IPC-7525 may have alternate design recommendations.
7. Board assembly site may have different recommendations for stencil design.

# DBV0005A



# PACKAGE OUTLINE

SOT-23 - 1.45 mm max height

SMALL OUTLINE TRANSISTOR



## NOTES:

1. All linear dimensions are in millimeters. Any dimensions in parenthesis are for reference only. Dimensioning and tolerancing per ASME Y14.5M.
2. This drawing is subject to change without notice.
3. Reference JEDEC MO-178.
4. Body dimensions do not include mold flash, protrusions, or gate burrs. Mold flash, protrusions, or gate burrs shall not exceed 0.25 mm per side.
5. Support pin may differ or may not be present.



# EXAMPLE BOARD LAYOUT

DBV0005A

SOT-23 - 1.45 mm max height

SMALL OUTLINE TRANSISTOR



LAND PATTERN EXAMPLE  
EXPOSED METAL SHOWN  
SCALE:15X

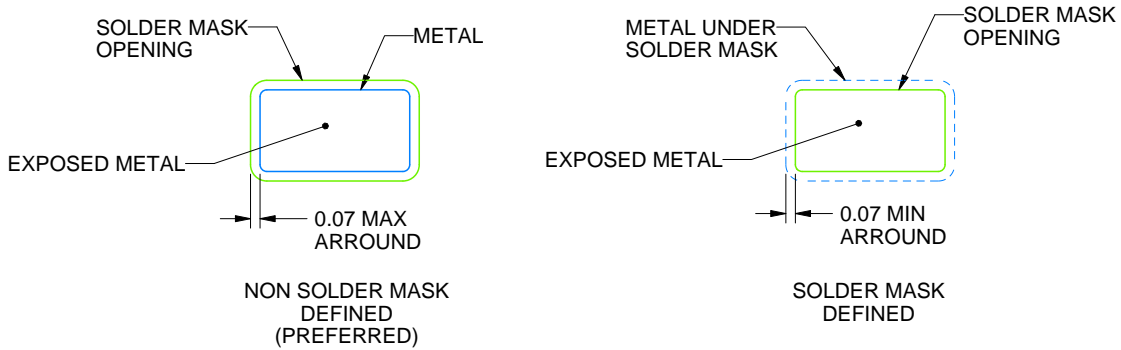

SOLDER MASK DETAILS

4214839/H 09/2023

NOTES: (continued)

6. Publication IPC-7351 may have alternate designs.

7. Solder mask tolerances between and around signal pads can vary based on board fabrication site.

# EXAMPLE STENCIL DESIGN

DBV0005A

SOT-23 - 1.45 mm max height

SMALL OUTLINE TRANSISTOR



SOLDER PASTE EXAMPLE  
BASED ON 0.125 mm THICK STENCIL  
SCALE:15X

4214839/H 09/2023

NOTES: (continued)

8. Laser cutting apertures with trapezoidal walls and rounded corners may offer better paste release. IPC-7525 may have alternate design recommendations.
9. Board assembly site may have different recommendations for stencil design.



Images above are just a representation of the package family, actual package may vary.  
Refer to the product data sheet for package details.

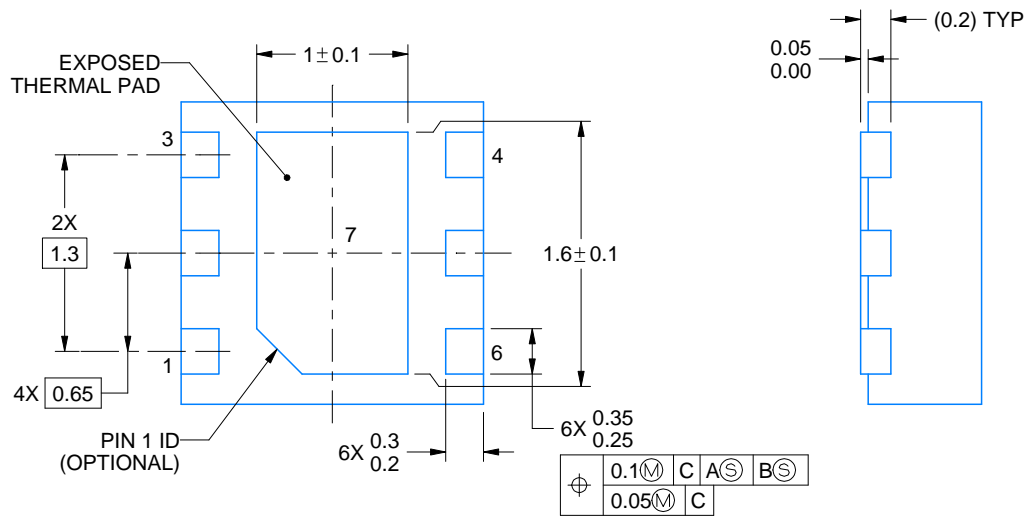

4222173/B 04/2018

NOTES:

1. All linear dimensions are in millimeters. Any dimensions in parenthesis are for reference only. Dimensioning and tolerancing per ASME Y14.5M.
2. This drawing is subject to change without notice.
3. The package thermal pad must be soldered to the printed circuit board for thermal and mechanical performance.



# EXAMPLE STENCIL DESIGN

DRV0006A

WSON - 0.8 mm max height

PLASTIC SMALL OUTLINE - NO LEAD



SOLDER PASTE EXAMPLE  
BASED ON 0.125 mm THICK STENCIL

EXPOSED PAD #7  
88% PRINTED SOLDER COVERAGE BY AREA UNDER PACKAGE  
SCALE:30X

4222173/B 04/2018

NOTES: (continued)

6. Laser cutting apertures with trapezoidal walls and rounded corners may offer better paste release. IPC-7525 may have alternate design recommendations.

## IMPORTANT NOTICE AND DISCLAIMER

TI PROVIDES TECHNICAL AND RELIABILITY DATA (INCLUDING DATA SHEETS), DESIGN RESOURCES (INCLUDING REFERENCE DESIGNS), APPLICATION OR OTHER DESIGN ADVICE, WEB TOOLS, SAFETY INFORMATION, AND OTHER RESOURCES "AS IS" AND WITH ALL FAULTS, AND DISCLAIMS ALL WARRANTIES, EXPRESS AND IMPLIED, INCLUDING WITHOUT LIMITATION ANY IMPLIED WARRANTIES OF MERCHANTABILITY, FITNESS FOR A PARTICULAR PURPOSE OR NON-INFRINGEMENT OF THIRD PARTY INTELLECTUAL PROPERTY RIGHTS.

These resources are intended for skilled developers designing with TI products. You are solely responsible for (1) selecting the appropriate TI products for your application, (2) designing, validating and testing your application, and (3) ensuring your application meets applicable standards, and any other safety, security, regulatory or other requirements.

These resources are subject to change without notice. TI grants you permission to use these resources only for development of an application that uses the TI products described in the resource. Other reproduction and display of these resources is prohibited. No license is granted to any other TI intellectual property right or to any third party intellectual property right. TI disclaims responsibility for, and you will fully indemnify TI and its representatives against, any claims, damages, costs, losses, and liabilities arising out of your use of these resources.

TI's products are provided subject to [TI's Terms of Sale](#) or other applicable terms available either on [ti.com](https://www.ti.com) or provided in conjunction with such TI products. TI's provision of these resources does not expand or otherwise alter TI's applicable warranties or warranty disclaimers for TI products.

TI objects to and rejects any additional or different terms you may have proposed.

Mailing Address: Texas Instruments, Post Office Box 655303, Dallas, Texas 75265  
Copyright © 2023, Texas Instruments Incorporated

单击下面可查看定价，库存，交付和生命周期等信息

[>>TI\(德州仪器\)](#)