

# OPAx145 高精度、低噪声、轨到轨输出、5.5MHz JFET 运算放大器

## 1 特性

- 理想带宽和转换率/功率比：
  - 增益带宽积：5.5MHz
  - 压摆率：20 V/ $\mu$ s
  - 低电源电流：475 $\mu$ A (最大值)
- 高精度：
  - 超低的失调电压：150  $\mu$ V (最大值)
  - 非常低的温漂：1  $\mu$ V/ $^{\circ}$ C (最大值)
- 低输入偏置电流：2pA
- 优异的抗噪性能：
  - 超低电压噪声：7nV/ $\sqrt{\text{Hz}}$
  - 超低电流噪声：0.8fA/ $\sqrt{\text{Hz}}$
- 输入电压范围包括 V<sub>-</sub> 电源
- 单电源运行：4.5V 至 36V
- 双电源供电： $\pm$ 2.25V 至  $\pm$ 18V

## 2 应用

- 半导体测试
- 实验室和现场仪表
- 源测量单元 (SMU)
- 称重计
- 数据中心内部互联 (地铁)
- 商用网络和服务器 PSU
- 直流电源、交流电源、电子负载
- 数据采集 (DAQ)

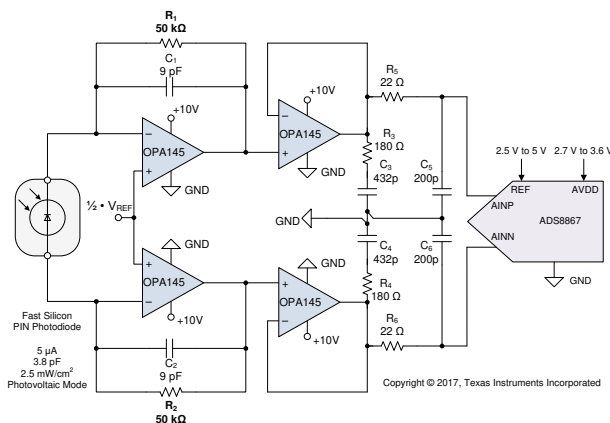

OPAx145 非常适用于 16 位 100kSPS 全差分跨阻成像应用

## 3 说明

OPA145 和 OPA2145 (OPAx145) 器件属于低功耗 JFET 输入放大器系列, 具有出色的漂移、低电流噪声和皮安级输入偏置电流。这些特性使得 OPAx145 非常适合放大高阻抗传感器产生的小信号。

现代的单电源精密模数转换器 (ADC) 和数模转换器 (DAC) 可实现轨到轨输出摆幅特性。此外, 包括 V<sub>-</sub> 的输入范围可以让设计人员简化电源管理并充分利用单电源低噪声 JFET 架构。

### 器件信息(1)

器件型号	封装	封装尺寸 (标称值)
OPA145	SOIC (8)	4.90mm × 3.91mm
	VSSOP (8)	3.00mm × 3.00mm
	SOT-23 (5)	2.90mm × 1.60mm
OPA2145	SOIC (8)	4.90mm × 3.91mm
	VSSOP (8)	3.00mm × 3.00mm

(1) 如需了解所有可用封装, 请参阅数据表末尾的封装选项附录。

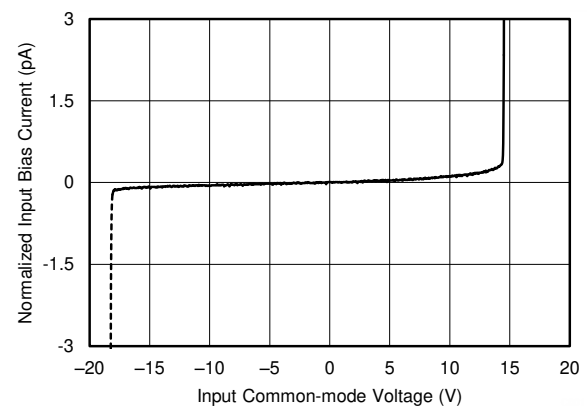

OPAx145 精密 JFET 技术可提供出色的线性输入阻抗



## Table of Contents

<b>1 特性</b> .....	<b>1</b>	<b>8 Application and Implementation</b> .....	<b>23</b>
<b>2 应用</b> .....	<b>1</b>	8.1 Application Information.....	23
<b>3 说明</b> .....	<b>1</b>	8.2 Typical Application.....	23
<b>4 Revision History</b> .....	<b>2</b>	8.3 System Examples.....	24
<b>5 Pin Configuration and Functions</b> .....	<b>3</b>	<b>9 Power Supply Recommendations</b> .....	<b>26</b>
<b>6 Specifications</b> .....	<b>4</b>	<b>10 Layout</b> .....	<b>26</b>
6.1 Absolute Maximum Ratings .....	4	10.1 Layout Guidelines.....	26
6.2 ESD Ratings .....	4	10.2 Layout Example.....	27
6.3 Recommended Operating Conditions .....	4	<b>11 Device and Documentation Support</b> .....	<b>28</b>
6.4 Thermal Information: OPA145 .....	5	11.1 Device Support.....	28
6.5 Thermal Information: OPA2145 .....	5	11.2 Documentation Support.....	28
6.6 Electrical Characteristics: $V_S = 4.5\text{ V to }36\text{ V}$ ; $\pm 2.25\text{ V to } \pm 18\text{ V}$ .....	6	11.3 Receiving Notification of Documentation Updates..	28
6.7 Typical Characteristics.....	8	11.4 支持资源.....	29
<b>7 Detailed Description</b> .....	<b>16</b>	11.5 Trademarks.....	29
7.1 Overview.....	16	11.6 静电放电警告.....	29
7.2 Functional Block Diagram.....	16	11.7 术语表.....	29
7.3 Feature Description.....	16	<b>12 Mechanical, Packaging, and Orderable Information</b> .....	<b>29</b>
7.4 Device Functional Modes.....	22		

## 4 Revision History

注：以前版本的页码可能与当前版本的页码不同

<b>Changes from Revision E (October 2020) to Revision F (February 2021)</b> .....	<b>Page</b>
• 将 OPA2145 D (SOIC-8) 和 DGK VSSOP-8) 封装从预告信息 ( 预发布 ) 更改为量产数据 ( 正在供货 ) .....	1
• Changed offset voltage drift specification to differentiate between OPA145 and OPA2145.....	6
• Changed PSRR specification to differentiate between OPA145 and OPA2145.....	6
<b>Changes from Revision D (June 2020) to Revision E (October 2020)</b> .....	<b>Page</b>
• 更新了整个文档中的表格、图和交叉参考的编号格式.....	1
• 添加了 OPA2145 预告信息 ( 预发布 ) DGK (VSSOP-8) 封装和相关内容.....	1
• Deleted <i>Operating Voltage</i> section; redundant information.....	16
<b>Changes from Revision C (July 2018) to Revision D (June 2020)</b> .....	<b>Page</b>
• 添加了 OPA2145 预告信息 ( 预发布 ) 器件 D (SOIC-8) 封装和相关内容.....	1
<b>Changes from Revision B (May 2018) to Revision C (July 2018)</b> .....	<b>Page</b>
• 从以下信息中删除了“预发布”：DBV (SOT-23) 封装，现已发布.....	1
• 将数据表状态更改为量产数据.....	1
<b>Changes from Revision A (March 2018) to Revision B (May 2018)</b> .....	<b>Page</b>
• 从以下信息中删除了“预发布”：DGK (VSSOP) 封装，现已发布.....	1
<b>Changes from Revision * (June 2017) to Revision A (March 2018)</b> .....	<b>Page</b>
• 添加了 DBV 和 DGK 封装的预发布；删除了与未来器件发布相关的内容.....	1

## 5 Pin Configuration and Functions



图 5-1. OPA145: D (8-Pin SOIC) and DGK (8-Pin VSSOP) Packages, Top View



图 5-2. OPA145: DBV (5-Pin SOT-23) Package, Top View

表 5-1. Pin Functions: OPA145

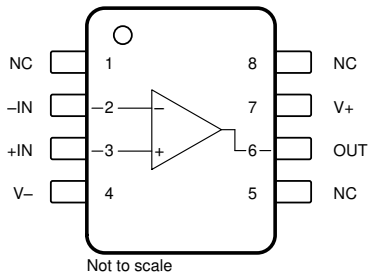
NAME	PIN		I/O	DESCRIPTION
	OPA145			
	D (SOIC), DGK (VSSOP)	DBV (SOT-23)		
- IN	2	4	I	Inverting input
+IN	3	3	I	Noninverting input
NC	1, 5, 8	—	—	No internal connection (can be left floating)
OUT	6	1	O	Output
V -	4	2	—	Negative (lowest) power supply
V+	7	5	—	Positive (highest) power supply

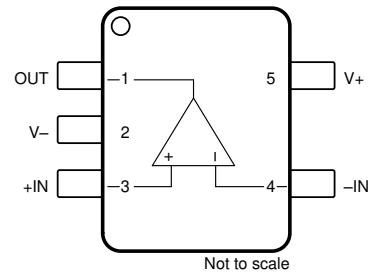

图 5-3. OPA2145: D (8-Pin SOIC) and DGK (8-Pin VSSOP) Packages, Top View

表 5-2. Pin Functions: OPA2145

NAME	PIN		I/O	DESCRIPTION
	OPA2145			
	D (SOIC), DGK (VSSOP)			
- IN A	2		I	Inverting input channel A
+IN A	3		I	Noninverting input channel A
- IN B	6		I	Inverting input channel B
+IN B	5		I	Noninverting input channel B
OUT A	1		O	Output channel A
OUT B	7		O	Output channel B
V -	4		—	Negative supply
V+	8		—	Positive supply

## 6 Specifications

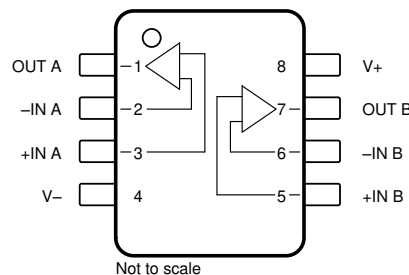
### 6.1 Absolute Maximum Ratings

over operating free-air temperature range (unless otherwise noted)<sup>(1)</sup>

		MIN	MAX	UNIT
V <sub>S</sub>	Supply voltage, (V+) - (V-)	Dual supply	±20	V
		Single supply	40	
	Signal input pins <sup>(2)</sup>	Voltage	(V-) - 0.5    (V+) + 0.5	V
		Current		±10
I <sub>SC</sub>	Output short-circuit <sup>(3)</sup>	Continuous	Continuous	
T <sub>A</sub>	Operating temperature	- 55	150	°C
T <sub>J</sub>	Junction temperature		150	°C
T <sub>STG</sub>	Storage temperature	- 65	150	°C

- (1) Stresses beyond those listed under *Absolute Maximum Ratings* may cause permanent damage to the device. These are stress ratings only, which do not imply functional operation of the device at these or any other conditions beyond those indicated under *Recommended Operating Conditions*. Exposure to absolute-maximum-rated conditions for extended periods may affect device reliability.
- (2) Input pins are diode-clamped to the power-supply rails. Input signals that can swing more than 0.5 V beyond the supply rails must be current limited to 10 mA or less.
- (3) Short-circuit to V<sub>S</sub> / 2 (ground in symmetrical dual-supply setups), one amplifier per package.

### 6.2 ESD Ratings

			VALUE	UNIT
V <sub>(ESD)</sub>	Electrostatic discharge	Human-body model (HBM), per ANSI/ESDA/JEDEC JS-001 <sup>(1)</sup>	±2000	V
		Charged-device model (CDM), per JEDEC specification JESD22-C101 <sup>(2)</sup>	±1000	

- (1) JEDEC document JEP155 states that 500-V HBM allows safe manufacturing with a standard ESD control process.
- (2) JEDEC document JEP157 states that 250-V CDM allows safe manufacturing with a standard ESD control process.

### 6.3 Recommended Operating Conditions

over operating free-air temperature range (unless otherwise noted)

		MIN	NOM	MAX	UNIT	
V <sub>S</sub>	Supply voltage, (V+) - (V-)	Dual supply	±2.25	±15	±18	V
		Single supply	4.5	30	36	
T <sub>A</sub>	Ambient temperature	- 40	25	125	°C	

## 6.4 Thermal Information: OPA145

THERMAL METRIC <sup>(1)</sup>		OPA145			UNIT
		D (SOIC)	DGK (VSSOP)	DBV (SOT)	
		8 PINS	8 PINS	5 PINS	
$R_{\theta JA}$	Junction-to-ambient thermal resistance	136	143	205	°C/W
$R_{\theta JC(top)}$	Junction-to-case (top) thermal resistance	74	47	200	°C/W
$R_{\theta JB}$	Junction-to-board thermal resistance	62	64	113	°C/W
$\Psi_{JT}$	Junction-to-top characterization parameter	19.7	5.3	38.2	°C/W
$\Psi_{JB}$	Junction-to-board characterization parameter	54.8	62.8	104.9	°C/W
$R_{\theta JC(bot)}$	Junction-to-case (bottom) thermal resistance	N/A	N/A	N/A	°C/W

(1) For more information about traditional and new thermal metrics, see the [Semiconductor and IC Package Thermal Metrics](#) application report.

## 6.5 Thermal Information: OPA2145

THERMAL METRIC <sup>(1)</sup>		OPA2145		UNIT
		D (SOIC)	DGK (VSSOP)	
		8 PINS	8 PINS	
$R_{\theta JA}$	Junction-to-ambient thermal resistance	118.7	163.9	°C/W
$R_{\theta JC(top)}$	Junction-to-case (top) thermal resistance	52.3	53.4	°C/W
$R_{\theta JB}$	Junction-to-board thermal resistance	63.5	85.0	°C/W
$\Psi_{JT}$	Junction-to-top characterization parameter	10.7	5.9	°C/W
$\Psi_{JB}$	Junction-to-board characterization parameter	62.4	83.7	°C/W
$R_{\theta JC(bot)}$	Junction-to-case (bottom) thermal resistance	N/A	N/A	°C/W

(1) For more information about traditional and new thermal metrics, see the [Semiconductor and IC Package Thermal Metrics](#) application report.

## 6.6 Electrical Characteristics: $V_S = 4.5\text{ V to }36\text{ V}$ ; $\pm 2.25\text{ V to } \pm 18\text{ V}$

at  $T_A = 25^\circ\text{C}$ ,  $R_L = 10\text{ k}\Omega$  connected to midsupply, and  $V_{CM} = V_{OUT} = \text{midsupply}$  (unless otherwise noted)

PARAMETER		TEST CONDITIONS	MIN	TYP	MAX	UNIT
<b>OFFSET VOLTAGE</b>						
$V_{OS}$	Offset voltage, RTI	$V_S = \pm 18\text{ V}$		$\pm 40$	$\pm 150$	$\mu\text{V}$
		$V_S = \pm 18\text{ V}$ , $T_A = 0^\circ\text{C to } +85^\circ\text{C}$			$\pm 280$	
		$V_S = \pm 18\text{ V}$ , $T_A = -40^\circ\text{C to } +125^\circ\text{C}$			$\pm 350$	
$dV_{OS}/dT$	Drift	$V_S = \pm 18\text{ V}$ , $T_A = 0^\circ\text{C to } +85^\circ\text{C}$ , OPA145ID and OPA145IDGK packages		$\pm 0.4$	$\pm 1$	$\mu\text{V}/^\circ\text{C}$
		$V_S = \pm 18\text{ V}$ , $T_A = 0^\circ\text{C to } +85^\circ\text{C}$ , OPA145IDBV package		$\pm 0.4$	$\pm 1.2$	
		$V_S = \pm 18\text{ V}$ , $T_A = -40^\circ\text{C to } +125^\circ\text{C}$ , OPA145ID and OPA145IDGK packages		$\pm 0.5$	$\pm 1.4$	
		$V_S = \pm 18\text{ V}$ , $T_A = -40^\circ\text{C to } +125^\circ\text{C}$ , OPA145IDBV package		$\pm 0.5$	$\pm 1.5$	
		$V_S = \pm 18\text{ V}$ , $T_A = 0^\circ\text{C to } +85^\circ\text{C}$ , OPA2145		$\pm 0.15$	$\pm 0.8$	
		$V_S = \pm 18\text{ V}$ , $T_A = -40^\circ\text{C to } +125^\circ\text{C}$ , OPA2145		$\pm 0.2$	$\pm 1$	
PSRR	Power-supply rejection ratio	$V_S = \pm 2.25\text{ V to } \pm 18\text{ V}$ , OPA145ID and OPA2145 packages		$\pm 0.06$	$\pm 0.3$	$\mu\text{V/V}$
		$V_S = \pm 2.25\text{ V to } \pm 18\text{ V}$ , OPA145IDGK and OPA145IDBV packages		$\pm 0.06$	$\pm 0.5$	
		$V_S = \pm 2.25\text{ V to } \pm 18\text{ V}$ , $T_A = -40^\circ\text{C to } +125^\circ\text{C}$ , OPA145			$\pm 2$	
		$V_S = \pm 2.25\text{ V to } \pm 18\text{ V}$ , $T_A = -40^\circ\text{C to } +125^\circ\text{C}$ , OPA2145			$\pm 0.65$	
<b>INPUT BIAS CURRENT</b>						
$I_B$	Input bias current			$\pm 2$	$\pm 10$	$\text{pA}$
		$T_A = 0^\circ\text{C to } +85^\circ\text{C}$			$\pm 600$	
		$T_A = -40^\circ\text{C to } +125^\circ\text{C}$			$\pm 10$	$\text{nA}$
$I_{OS}$	Input offset current			$\pm 2$	$\pm 10$	$\text{pA}$
		$T_A = 0^\circ\text{C to } +85^\circ\text{C}$			$\pm 600$	
		$T_A = -40^\circ\text{C to } +125^\circ\text{C}$			$\pm 10$	$\text{nA}$
<b>NOISE</b>						
	Input voltage noise	$f = 0.1\text{ Hz to } 10\text{ Hz}$		320		$\text{nV}_{PP}$
		$f = 0.1\text{ Hz to } 10\text{ Hz}$		60		$\text{nV}_{RMS}$
$e_n$	Input voltage noise density	$f = 10\text{ Hz}$		9		$\text{nV}/\sqrt{\text{Hz}}$
		$f = 100\text{ Hz}$		7.2		
		$f = 1\text{ kHz}$		7		
$I_n$	Input current noise density	$f = 1\text{ kHz}$		0.8		$\text{fA}/\sqrt{\text{Hz}}$
<b>INPUT VOLTAGE RANGE</b>						
$V_{CM}$	Common-mode voltage range	$T_A = -40^\circ\text{C to } +125^\circ\text{C}$	$(V^-) - 0.1$		$(V^+) - 3.5$	$\text{V}$
CMRR	Common-mode rejection ratio	$V_S = \pm 18\text{ V}$ , $V_{CM} = (V^-) - 0.1\text{ V to } (V^+) - 3.5\text{ V}$	126	140		$\text{dB}$
		$V_S = \pm 18\text{ V}$ , $V_{CM} = (V^-) - 0.1\text{ V to } (V^+) - 3.5\text{ V}$ , $T_A = -40^\circ\text{C to } +125^\circ\text{C}$	118			
<b>INPUT IMPEDANCE</b>						
	Differential			$10^{13} \parallel 5$		$\Omega \parallel \text{pF}$
	Common-mode	$V_{CM} = (V^-) - 0.1\text{ V to } (V^+) - 3.5\text{ V}$		$10^{13} \parallel 4.3$		

## 6.6 Electrical Characteristics: $V_S = 4.5\text{ V to }36\text{ V}; \pm 2.25\text{ V to } \pm 18\text{ V}$ (continued)

at  $T_A = 25^\circ\text{C}$ ,  $R_L = 10\text{ k}\Omega$  connected to midsupply, and  $V_{CM} = V_{OUT} = \text{midsupply}$  (unless otherwise noted)

PARAMETER		TEST CONDITIONS	MIN	TYP	MAX	UNIT
<b>OPEN-LOOP GAIN</b>						
$A_{OL}$	Open-loop voltage gain	$V_O = (V^-) + 0.35\text{ V to } (V^+) - 0.35\text{ V}$ , $R_L = 10\text{ k}\Omega$ , OPA145ID package only	118	123		dB
		$V_O = (V^-) + 0.35\text{ V to } (V^+) - 0.35\text{ V}$ , $R_L = 10\text{ k}\Omega$ , OPA145IDGK and OPA145IDBV packages	110	123		
		$V_O = (V^-) + 0.35\text{ V to } (V^+) - 0.35\text{ V}$ , $R_L = 10\text{ k}\Omega$ , OPA2145	114	123		
		$V_O = (V^-) + 0.35\text{ V to } (V^+) - 0.35\text{ V}$ , $R_L = 2\text{ k}\Omega$	106	110		
		$V_O = (V^-) + 0.35\text{ V to } (V^+) - 0.35\text{ V}$ , $R_L = 2\text{ k}\Omega$ , OPA2145	104	110		
		$V_O = (V^-) + 0.35\text{ V to } (V^+) - 0.35\text{ V}$ , $R_L = 2\text{ k}\Omega$ , $T_A = -40^\circ\text{C to } +125^\circ\text{C}$	104			
<b>FREQUENCY RESPONSE</b>						
BW	Gain bandwidth product			5.5		MHz
SR	Slew rate			20		V/ $\mu\text{s}$
	Settling time	12 bits	10-V step, $G = +1$	1.6		$\mu\text{s}$
		16 bits	10-V step, $G = +1$	6		
THD+N	Total harmonic distortion and noise	1 kHz, $G = +1$ , $V_O = 3.5 V_{RMS}$		0.0001%		
	Overload recovery time			600		ns
<b>OUTPUT</b>						
	Linear output voltage swing range	$R_L = 10\text{ k}\Omega$ , $A_{OL} \geq 108\text{ dB}$ , $T_A = -40^\circ\text{C to } +125^\circ\text{C}$ , see <a href="#">Fig 6-24</a> and <a href="#">Fig 6-25</a>	$(V^-) + 0.1$		$(V^+) - 0.1$	V
		$R_L = 2\text{ k}\Omega$ , $A_{OL} \geq 108\text{ dB}$ , $T_A = -40^\circ\text{C to } +125^\circ\text{C}$ , see <a href="#">Fig 6-24</a> and <a href="#">Fig 6-25</a>	$(V^-) + 0.3$		$(V^+) - 0.3$	
$V_O$	Voltage output swing from rail	$R_L = 10\text{ k}\Omega$			75	mV
		$R_L = 10\text{ k}\Omega$ , OPA2145			80	
		$R_L = 10\text{ k}\Omega$ , $T_A = -40^\circ\text{C to } +125^\circ\text{C}$			90	
		$R_L = 2\text{ k}\Omega$			210	
		$R_L = 2\text{ k}\Omega$ , OPA2145			230	
		$R_L = 2\text{ k}\Omega$ , $T_A = -40^\circ\text{C to } +125^\circ\text{C}$ , OPA145ID			250	
		$R_L = 2\text{ k}\Omega$ , $T_A = -40^\circ\text{C to } +125^\circ\text{C}$ , OPA145IDGK and OPA145IDBV packages, OPA2145			350	
$I_{SC}$	Short-circuit current			$\pm 20$		mA
$C_{LOAD}$	Capacitive load drive			See <a href="#">Fig 6-27</a>		
$R_O$	Open-loop output impedance	$f = 1\text{ MHz}$ , $I_O = 0\text{ mA}$ (see <a href="#">Fig 6-26</a> )		150		$\Omega$
<b>POWER SUPPLY</b>						
$I_Q$	Quiescent current (per amplifier)	$I_O = 0\text{ mA}$		445	475	$\mu\text{A}$
		$T_A = 0^\circ\text{C to } +85^\circ\text{C}$			590	
		$T_A = -40^\circ\text{C to } +125^\circ\text{C}$			655	

## 6.7 Typical Characteristics

at  $T_A = 25^\circ\text{C}$ ,  $V_S = \pm 18\text{ V}$ ,  $V_{CM} = V_S / 2$ ,  $R_{LOAD} = 10\text{ k}\Omega$  connected to  $V_S / 2$ , and  $C_L = 100\text{ pF}$  (unless otherwise noted)

表 6-1. Table of Graphs

DESCRIPTION	FIGURE
Offset Voltage Production Distribution	图 6-1
Offset Voltage Drift Distribution From $-40^\circ\text{C}$ to $+125^\circ\text{C}$	图 6-2
Input Bias Current Production Distribution	图 6-3
Input Offset Current Production Distribution	图 6-4
Offset Voltage vs Temperature	图 6-5
Offset Voltage vs Common-Mode Voltage	图 6-6
Offset Voltage vs Power Supply	图 6-7
Open-Loop Gain and Phase vs Frequency	图 6-8
Closed-Loop Gain vs Frequency	图 6-9
Input Bias Current vs Common-Mode Voltage	图 6-10
Input Bias Current and Offset vs Temperature	图 6-11
Output Voltage Swing vs Output Current (Maximum Supply)	图 6-12
CMRR and PSRR vs Frequency	图 6-13
CMRR vs Temperature	图 6-14
PSRR vs Temperature	图 6-15
0.1-Hz to 10-Hz Voltage Noise	图 6-16
Input Voltage Noise Spectral Density vs Frequency	图 6-17
THD+N Ratio vs Frequency	图 6-18
THD+N vs Output Amplitude	图 6-19
Quiescent Current vs Supply Voltage	图 6-20
Quiescent Current vs Temperature	图 6-21
Open-Loop Gain vs Temperature ( $10\text{-k}\Omega$ )	图 6-22
Open-Loop Gain vs Temperature ( $2\text{-k}\Omega$ )	图 6-23
DC Open-Loop Gain vs Output Voltage Swing Relative to Supply	图 6-24, 图 6-25
Open-Loop Output Impedance vs Frequency	图 6-26
Small-Signal Overshoot vs Capacitive Load ( $10\text{-mV}$ Step)	图 6-27
No Phase Reversal	图 6-28
Positive Overload Recovery	图 6-29
Negative Overload Recovery	图 6-30
Small-Signal Step Response ( $10\text{-mV}$ Step)	图 6-31, 图 6-32
Large-Signal Step Response ( $10\text{-V}$ Step)	图 6-33, 图 6-34
Settling Time	图 6-35
Short-Circuit Current vs Temperature	图 6-36
Maximum Output Voltage vs Frequency	图 6-37
EMIRR vs Frequency	图 6-38



### 6.7 Typical Characteristics (continued)

at  $T_A = 25^\circ\text{C}$ ,  $V_S = \pm 18\text{ V}$ ,  $V_{CM} = V_S / 2$ ,  $R_{LOAD} = 10\text{ k}\Omega$  connected to  $V_S / 2$ , and  $C_L = 100\text{ pF}$  (unless otherwise noted)



图 6-1. Offset Voltage Production Distribution



图 6-2. Offset Voltage Drift Distribution From  $-40^\circ\text{C}$  to  $+125^\circ\text{C}$

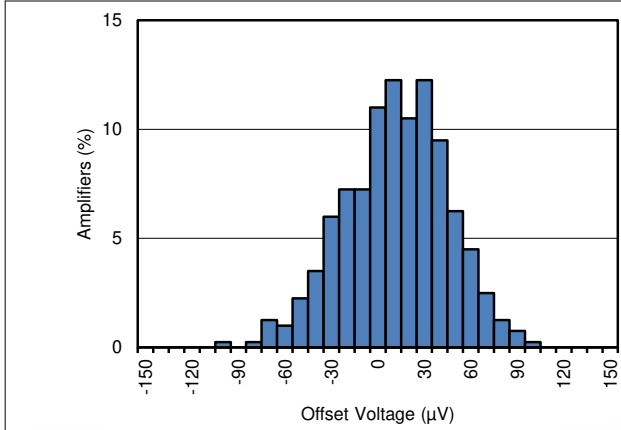

图 6-3. Input Bias Current Production Distribution

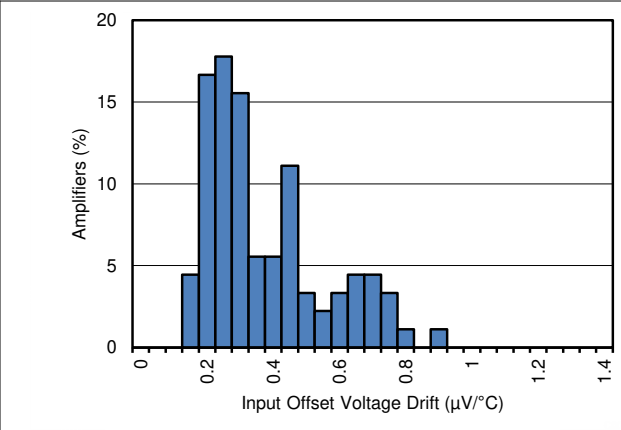

图 6-4. Input Offset Current Production Distribution

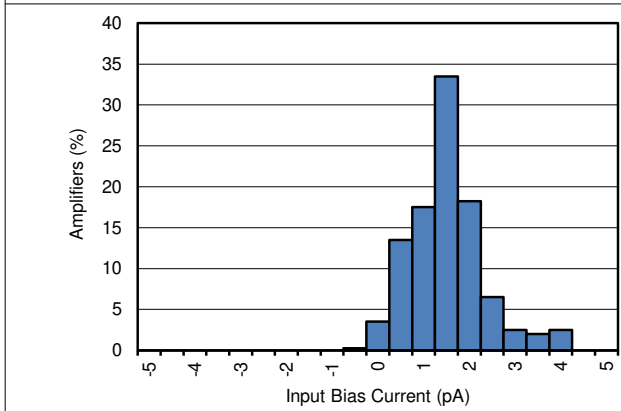

图 6-5. Offset Voltage vs Temperature

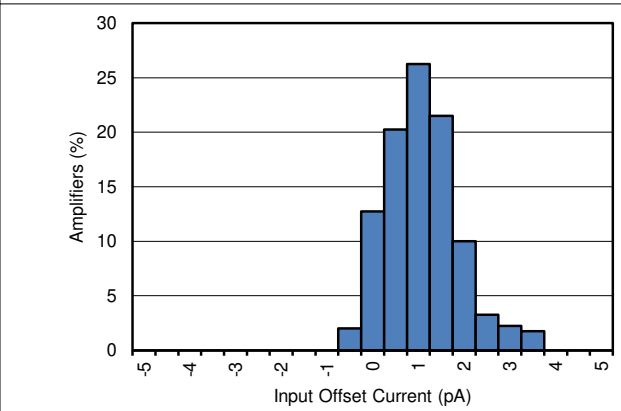

图 6-6. Offset Voltage vs Common-Mode Voltage

### 6.7 Typical Characteristics (continued)

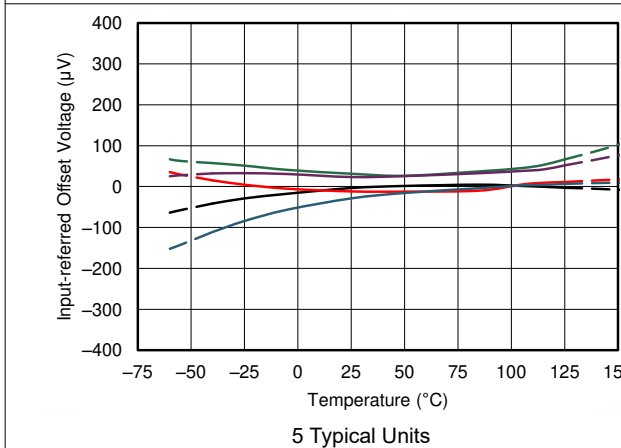
at  $T_A = 25^\circ\text{C}$ ,  $V_S = \pm 18\text{ V}$ ,  $V_{CM} = V_S / 2$ ,  $R_{LOAD} = 10\text{ k}\Omega$  connected to  $V_S / 2$ , and  $C_L = 100\text{ pF}$  (unless otherwise noted)

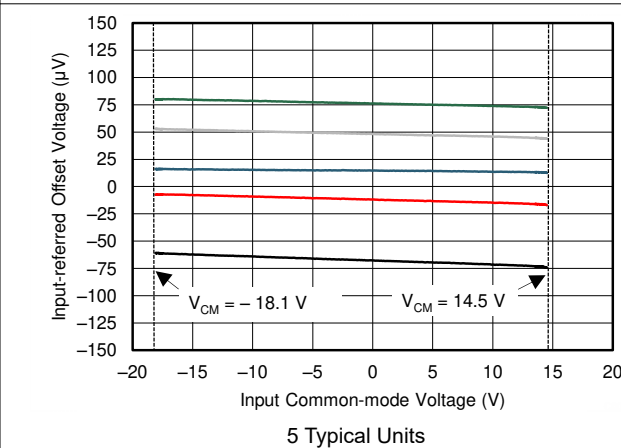

图 6-7. Offset Voltage vs Supply Voltage



图 6-8. Open-Loop Gain and Phase vs Frequency

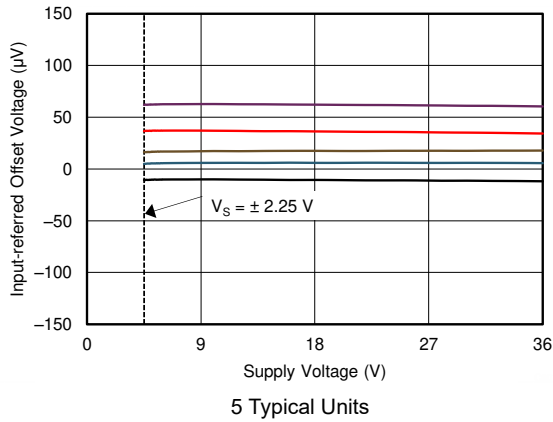

图 6-9. Closed-Loop Gain vs Frequency

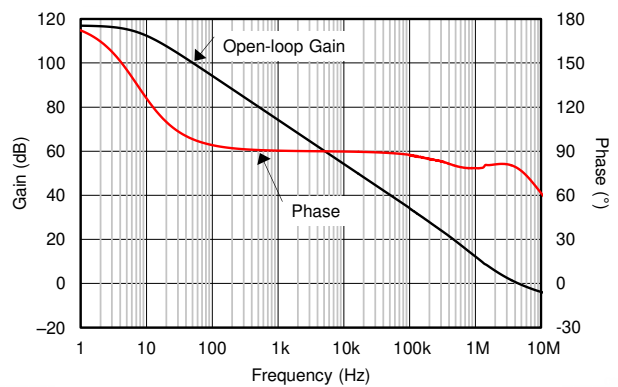

图 6-10. Input Bias Current vs Common-Mode Voltage

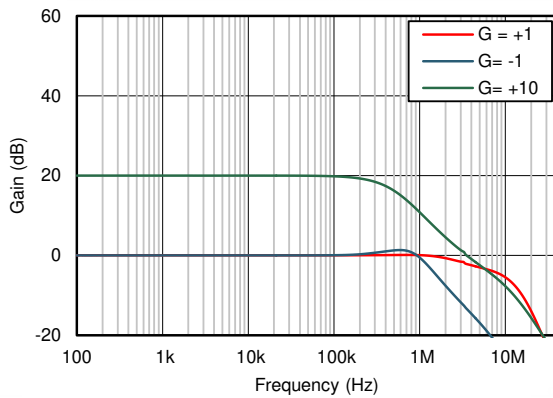

图 6-11. Input Bias Current and Offset vs Temperature

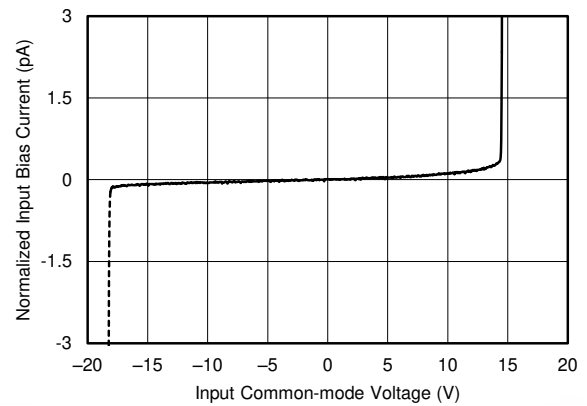

图 6-12. Output Voltage Swing vs Output Current (Maximum Supply)

### 6.7 Typical Characteristics (continued)

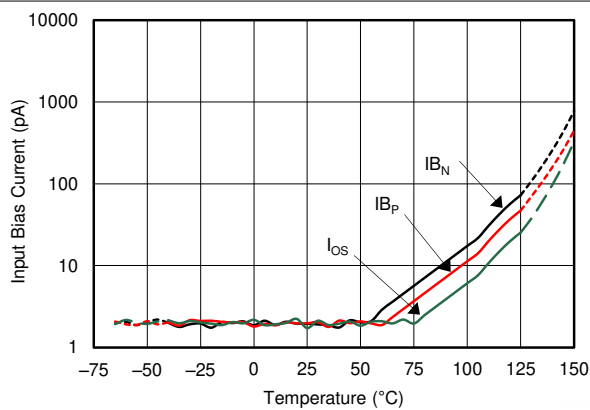
at  $T_A = 25^\circ\text{C}$ ,  $V_S = \pm 18\text{ V}$ ,  $V_{CM} = V_S / 2$ ,  $R_{LOAD} = 10\text{ k}\Omega$  connected to  $V_S / 2$ , and  $C_L = 100\text{ pF}$  (unless otherwise noted)

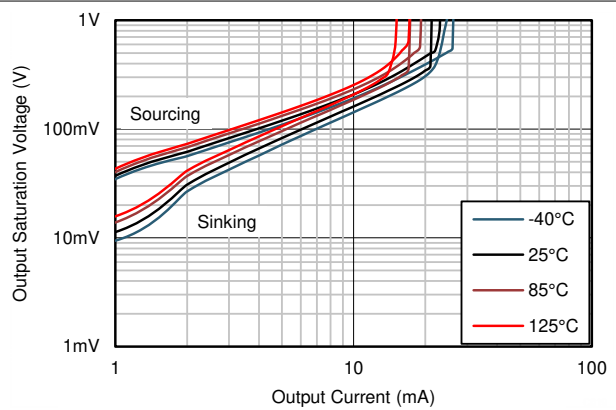

图 6-13. CMRR and PSRR vs Frequency



图 6-14. CMRR vs Temperature

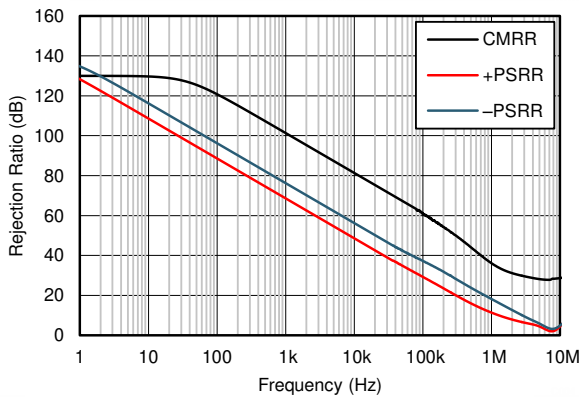

图 6-15. PSRR vs Temperature

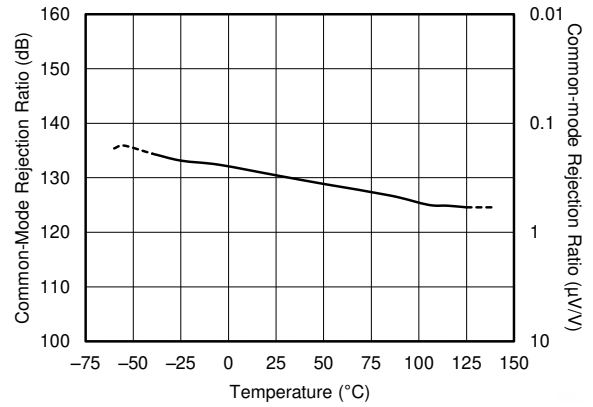

图 6-16. 0.1-Hz to 10-Hz Voltage Noise

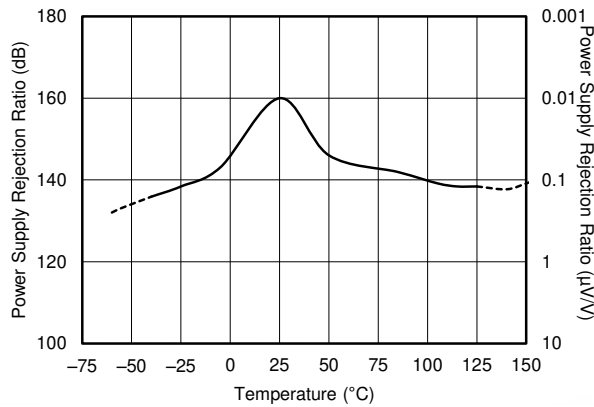

图 6-17. Input Voltage Noise Spectral Density vs Frequency

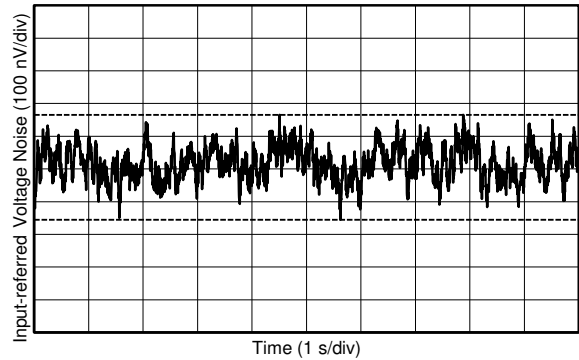

$V_{OUT} = 3.5$   $V_{RMS, BW} = 90\text{ kHz}$

图 6-18. THD+N Ratio vs Frequency

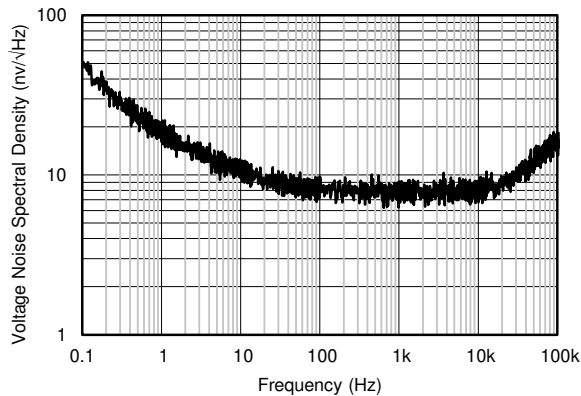
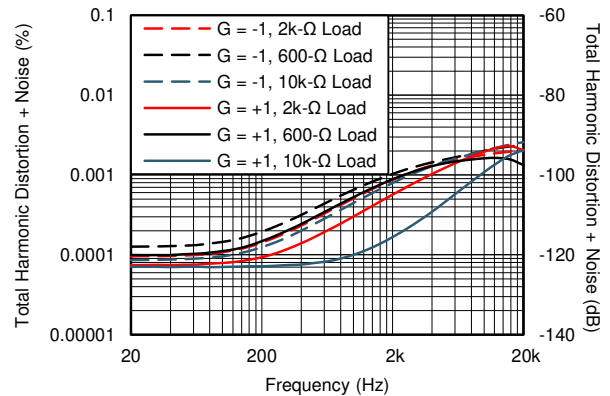
### 6.7 Typical Characteristics (continued)

at  $T_A = 25^\circ\text{C}$ ,  $V_S = \pm 18\text{ V}$ ,  $V_{CM} = V_S / 2$ ,  $R_{LOAD} = 10\text{ k}\Omega$  connected to  $V_S / 2$ , and  $C_L = 100\text{ pF}$  (unless otherwise noted)

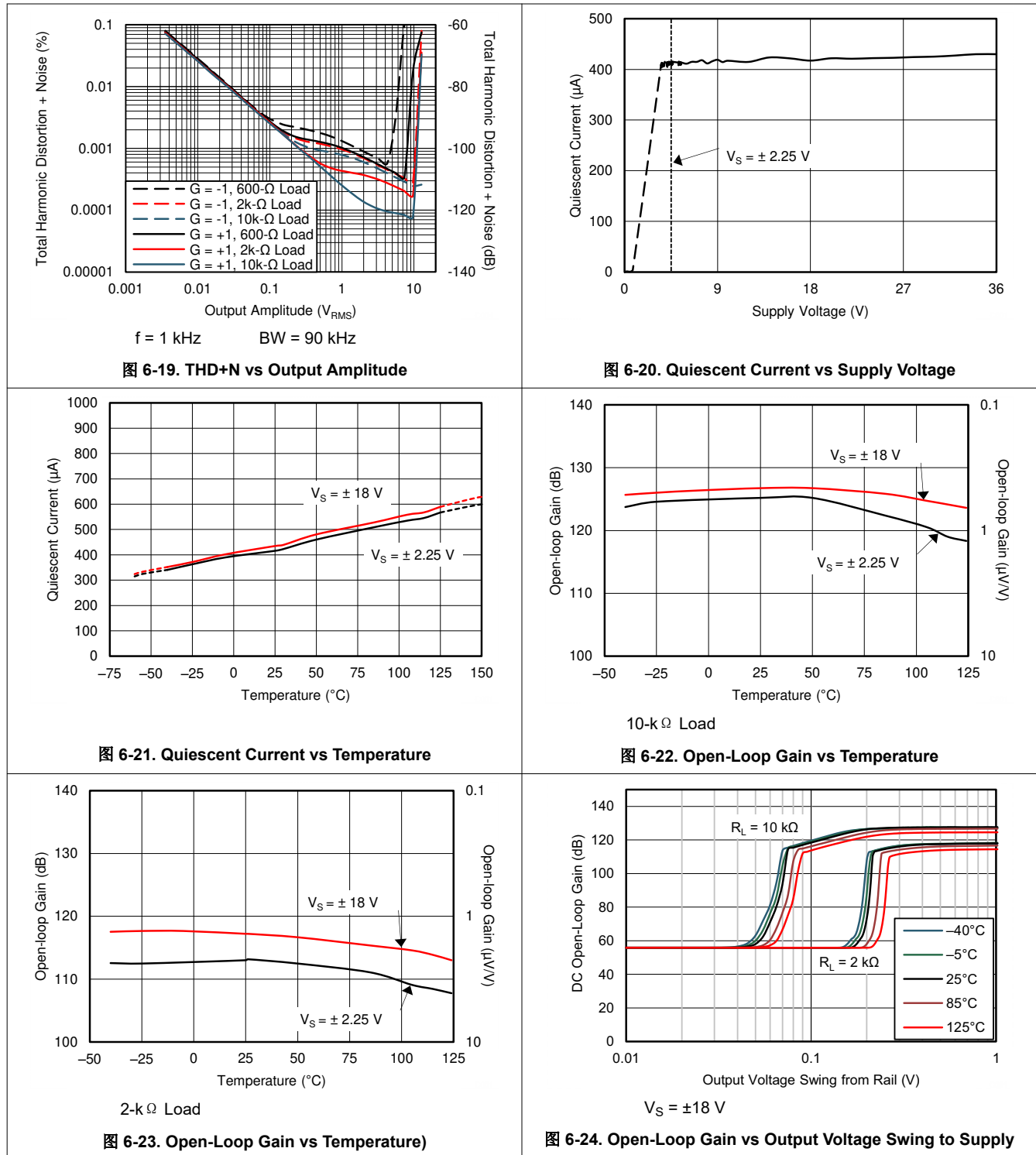

### 6.7 Typical Characteristics (continued)

at  $T_A = 25^\circ\text{C}$ ,  $V_S = \pm 18\text{ V}$ ,  $V_{CM} = V_S / 2$ ,  $R_{LOAD} = 10\text{ k}\Omega$  connected to  $V_S / 2$ , and  $C_L = 100\text{ pF}$  (unless otherwise noted)



图 6-25. Open-Loop Gain vs Output Voltage Swing to Supply



图 6-26. Open-Loop Output Impedance vs Frequency

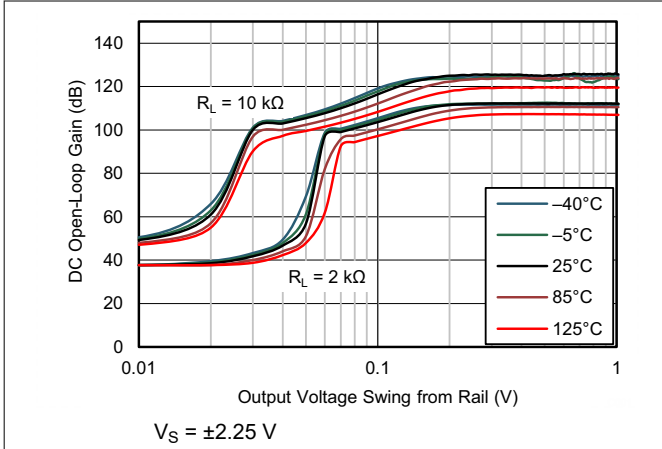

图 6-27. Small-Signal Overshoot vs Capacitive Load

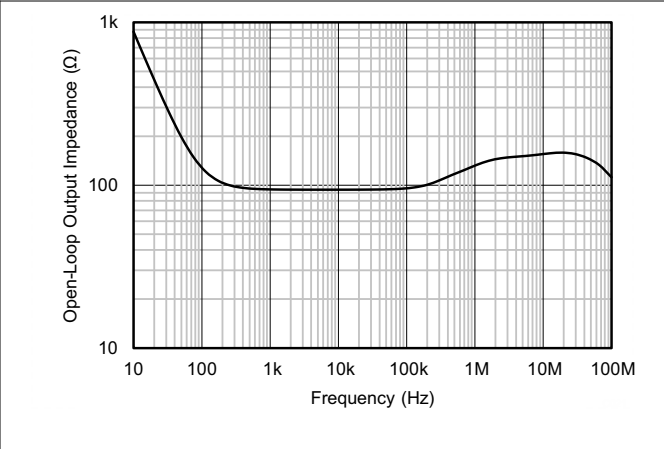

图 6-28. No Phase Reversal

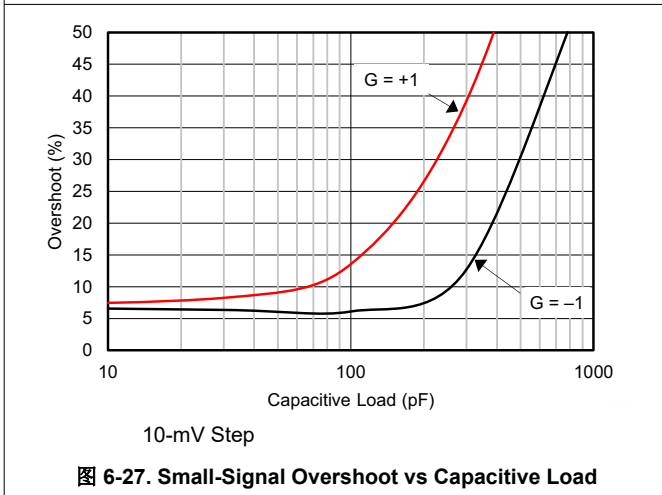

图 6-29. Positive Overload Recovery

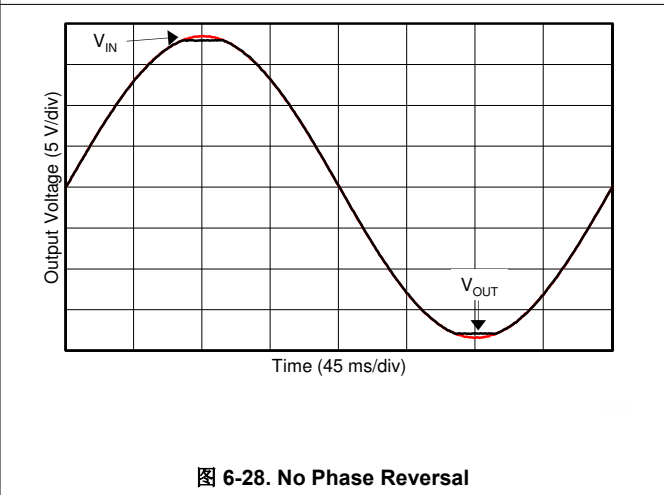

图 6-30. Negative Overload Recovery

### 6.7 Typical Characteristics (continued)

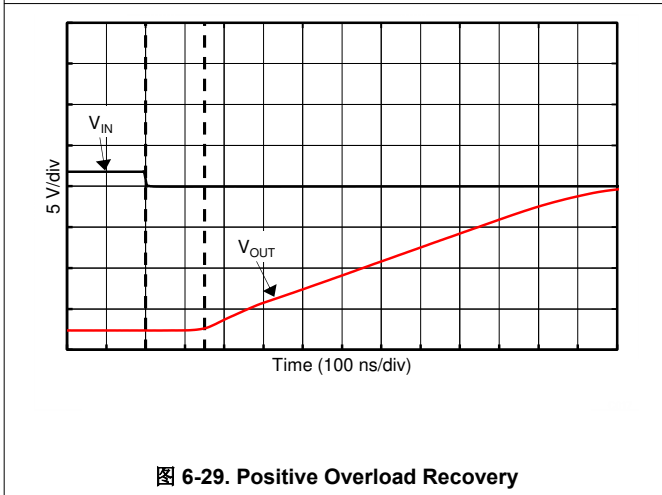
at  $T_A = 25^\circ\text{C}$ ,  $V_S = \pm 18\text{ V}$ ,  $V_{CM} = V_S / 2$ ,  $R_{LOAD} = 10\text{ k}\Omega$  connected to  $V_S / 2$ , and  $C_L = 100\text{ pF}$  (unless otherwise noted)

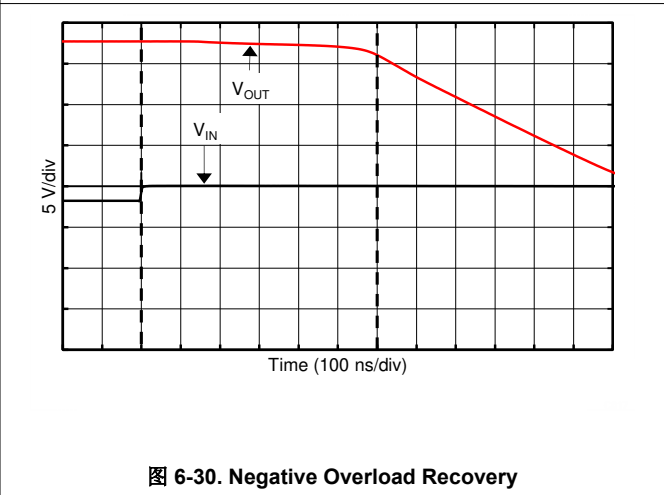
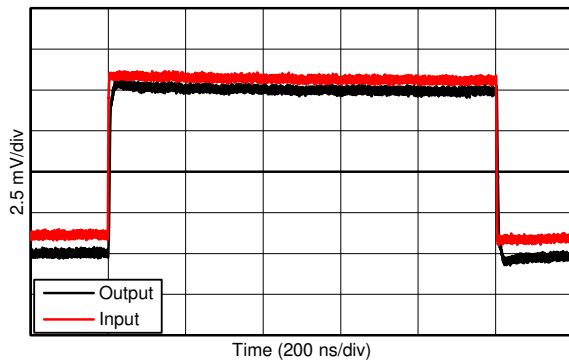

$G = +1$

图 6-31. Small-Signal Step Response (10-mV Step)

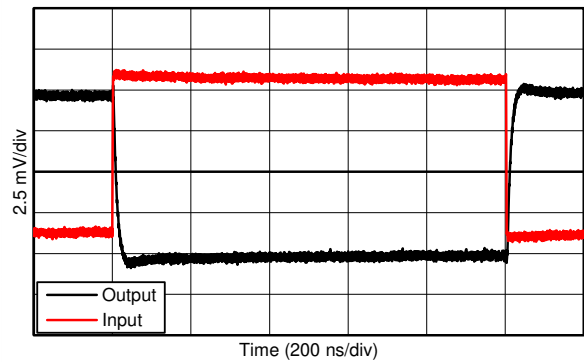

10-mV Step

$G = -1$

图 6-32. Small-Signal Step Response

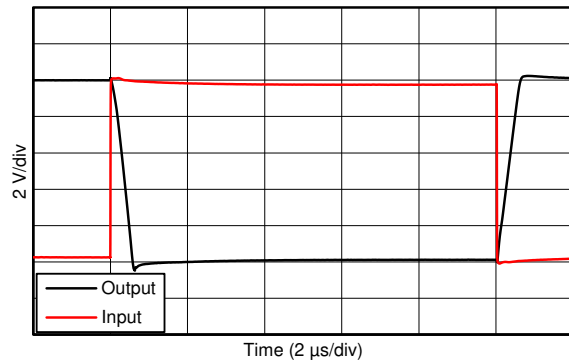

10-V Step

$G = -1$

图 6-33. Large-Signal Step Response

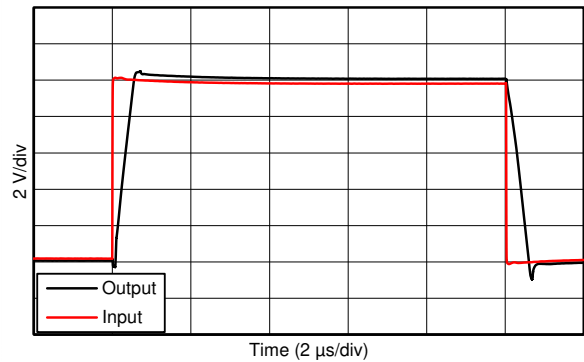

10-V Step

$G = +1$

图 6-34. Large-Signal Step Response

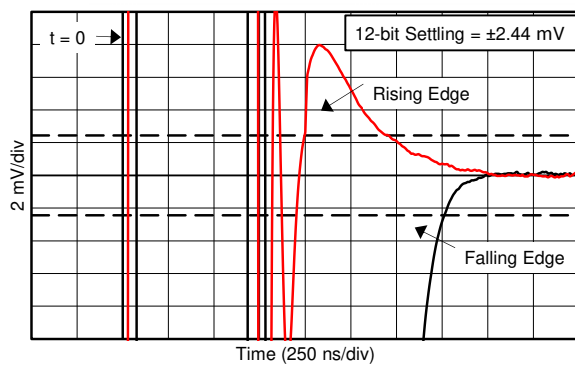

12-bit settling on 10-V step =  $\pm 2.44\text{ mV}$

图 6-35. Settling Time (10-V Step)



图 6-36. Short-Circuit Current vs Temperature

### 6.7 Typical Characteristics (continued)

at  $T_A = 25^\circ\text{C}$ ,  $V_S = \pm 18\text{ V}$ ,  $V_{CM} = V_S / 2$ ,  $R_{LOAD} = 10\text{ k}\Omega$  connected to  $V_S / 2$ , and  $C_L = 100\text{ pF}$  (unless otherwise noted)

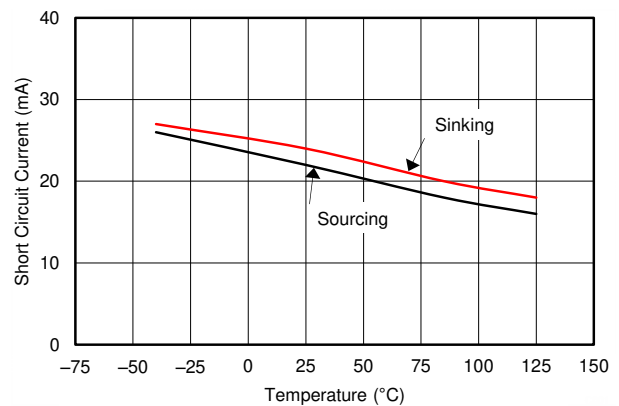
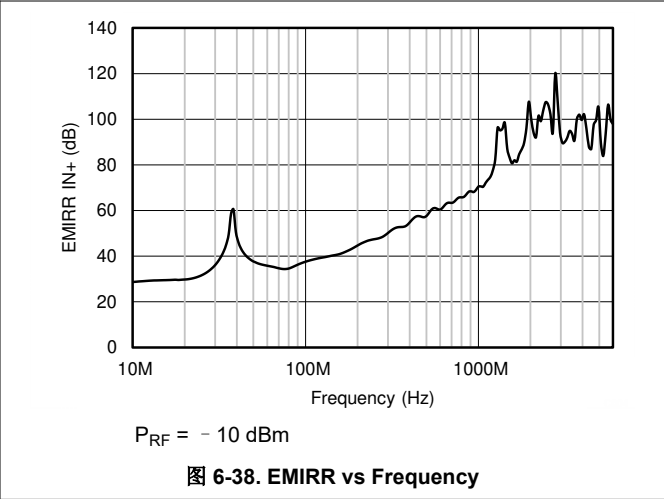
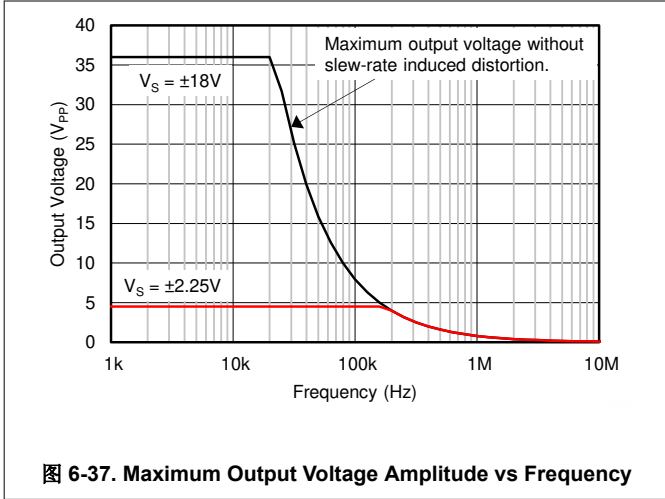

## 7 Detailed Description

### 7.1 Overview

The OPA145 and OPA2145 (OPAx145) operational amplifiers are part of a family of low-power JFET input amplifiers that feature superior drift performance and low input bias current. The rail-to-rail output swing and input range that includes  $V^-$  allow designers to use the low-noise characteristics of JFET amplifier while also interfacing to modern, single-supply, precision, analog-to-digital converters (ADCs) and digital-to-analog converters (DACs). The OPAx145 achieve 5.5-MHz gain-bandwidth product and  $20\text{-V}/\mu\text{s}$  slew rate and consume only  $445\ \mu\text{A}$  (typical) of quiescent current, making these devices an excellent choice for low-power applications. These devices operate on a single 4.5-V to 36-V supply or dual  $\pm 2.25\text{-V}$  to  $\pm 18\text{-V}$  supplies.

The OPAx145 are fully specified from  $-40^\circ\text{C}$  to  $+125^\circ\text{C}$  for use in the most challenging environments. The single-channel OPA145 is available in 5-pin SOT-23, 8-pin SOIC, and 8-pin VSSOP packages. The dual-channel OPA2145 is available in 8-pin SOIC and 8-pin VSSOP packages.

# 7.2 shows the simplified diagram of the OPAx145.

### 7.2 Functional Block Diagram

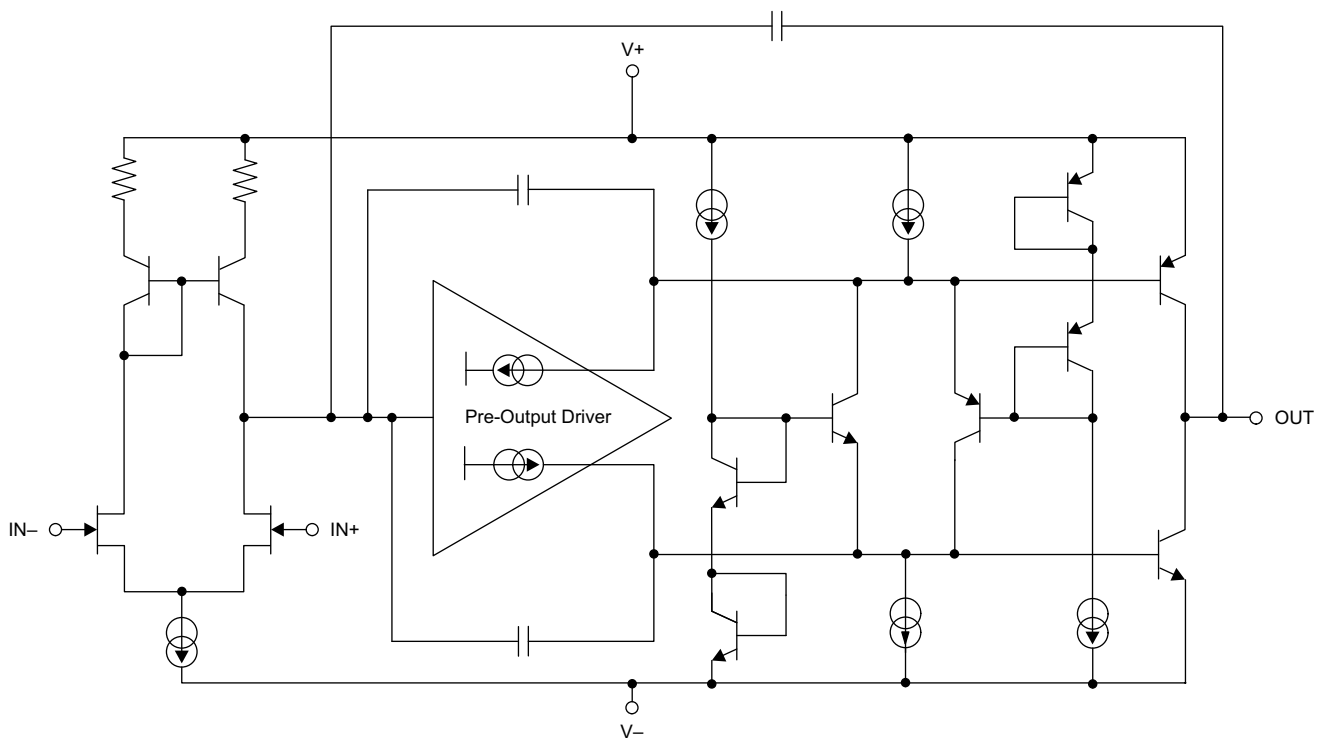

Copyright © 2017, Texas Instruments Incorporated

### 7.3 Feature Description

#### 7.3.1 Capacitive Load and Stability

The dynamic characteristics of the OPAx145 have been optimized for commonly encountered gains, loads, and operating conditions. The combination of low closed-loop gain and high capacitive loads decreases the phase margin of the amplifier and can lead to gain peaking or oscillations. As a result, heavier capacitive loads must be isolated from the output. The simplest way to achieve this isolation is to add a small resistor ( $R_{OUT}$  equal to  $50\ \Omega$ , for example) in series with the output.

Figure 6-27 illustrates the effects on small-signal overshoot for several capacitive loads. Also, see [Feedback Plots Define Op Amp AC Performance](#), available for download from the [TI website](#), for details of analysis techniques and application circuits.



### 7.3.2 Output Current Limit

The output current of the OPAx145 is limited by internal circuitry to +20 mA (sinking) and - 20 mA (sourcing) to protect the device if the output is accidentally shorted. This short-circuit current depends on temperature, as shown in 图 6-36.

### 7.3.3 Noise Performance

图 7-1 shows the total circuit noise for varying source impedances with the operational amplifier in a unity-gain configuration (with no feedback resistor network and therefore no additional noise contributions). The OPAx145 and OPAx211 are shown with total circuit noise calculated. The op amp contributes both a voltage noise component and a current noise component. The voltage noise is commonly modeled as a time-varying component of the offset voltage. The current noise is modeled as the time-varying component of the input bias current and reacts with the source resistance to create a voltage component of noise. Therefore, the lowest noise op amp for a given application depends on the source impedance. For low source impedance, current noise is negligible, and voltage noise generally dominates. The OPAx145 has both low voltage noise and extremely low current noise because of the FET input of the op amp. As a result, the current noise contribution of the OPAx145 is negligible for any practical source impedance, which makes it the better choice for applications with high source impedance.

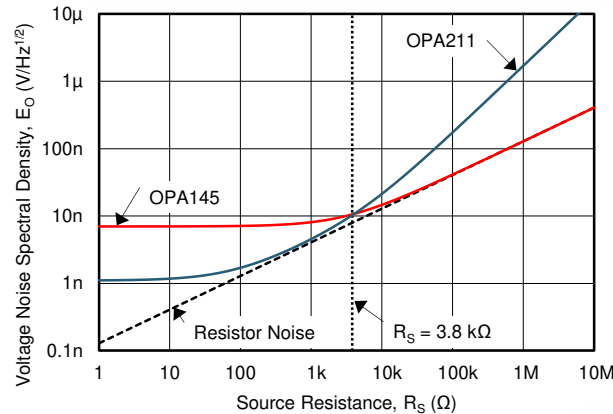

NOTE: For a source resistance,  $R_S$ , greater than 3.8 k $\Omega$ , the OPAx145 is a lower-noise option compared to the OPA211, as shown in 图 7-1.

图 7-1. Noise Performance of the OPAx145 and OPA211 in Unity-Gain Buffer Configuration

方程式 1 can be used to calculate the total noise at the output of the amplifier. A plot can be created using this equation to quickly compare the noise performance of two different amplifiers when used with different source resistances, as is shown in 图 7-1.

$$E_O^2 = e_n^2 + (i_n \times R_S)^2 + 4kTR_S \quad (1)$$

where:

- $e_n$  = voltage noise
- $i_n$  = current noise
- $R_S$  = source impedance
- $k$  = Boltzmann's constant =  $1.38 \times 10^{-23}$  J/K
- $T$  = temperature in kelvins (K)

For more details on calculating noise, see 节 7.3.4.

### 7.3.4 Basic Noise Calculations

Low-noise circuit design requires careful analysis of all noise sources. External noise sources can dominate in many cases; consider the effect of source resistance on overall op amp noise performance. Total noise of the circuit is the root-sum-square combination of all noise components.

The resistive portion of the source impedance produces thermal noise proportional to the square root of the resistance. This function is plotted in [Figure 7-1](#). The source impedance is usually fixed; consequently, select the op amp and the feedback resistors to minimize the respective contributions to the total noise.

[Figure 7-2](#) illustrates both noninverting (A) and inverting (B) op amp circuit configurations with gain. In circuit configurations with gain, the feedback network resistors also contribute noise. In general, the current noise of the op amp reacts with the feedback resistors to create additional noise components. However, the extremely low current noise of the OPAx145 means that the current noise contribution can be neglected.

The feedback resistor values can generally be chosen to make these noise sources negligible. Low impedance feedback resistors load the output of the amplifier. The equations for total noise are shown for both configurations.

#### (A) Noise in Noninverting Gain Configuration

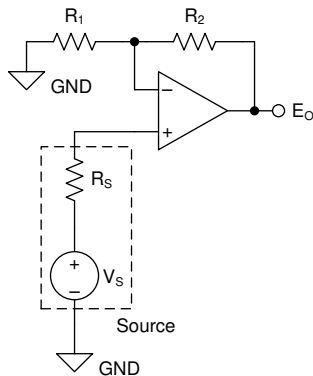

Noise at the output is given as  $E_o$ , where

$$(1) \quad E_o = \left(1 + \frac{R_2}{R_1}\right) \cdot \sqrt{(e_N)^2 + (e_N)^2 + (e_{R_1 \parallel R_2})^2 + (i_N \cdot R_S)^2 + \left(i_N \cdot \left[\frac{R_1 \cdot R_2}{R_1 + R_2}\right]\right)^2} \quad [V_{RMS}]$$

$$(2) \quad e_S = \sqrt{4 \cdot k_B \cdot T(K) \cdot R_S} \quad \left[\frac{V}{\sqrt{Hz}}\right] \quad \text{Thermal noise of } R_S$$

$$(3) \quad e_{R_1 \parallel R_2} = \sqrt{4 \cdot k_B \cdot T(K) \cdot \left[\frac{R_1 \cdot R_2}{R_1 + R_2}\right]} \quad \left[\frac{V}{\sqrt{Hz}}\right] \quad \text{Thermal noise of } R_1 \parallel R_2$$

$$(4) \quad k_B = 1.38065 \cdot 10^{-23} \quad \left[\frac{J}{K}\right] \quad \text{Boltzmann Constant}$$

$$(5) \quad T(K) = 237.15 + T(^{\circ}C) \quad [K] \quad \text{Temperature in kelvins}$$

#### (B) Noise in Inverting Gain Configuration

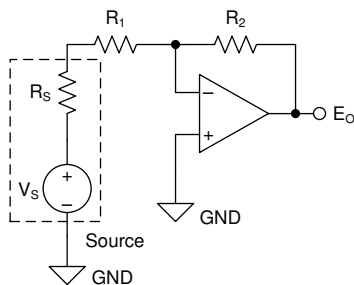

Noise at the output is given as  $E_o$ , where

$$(6) \quad E_o = \left(1 + \frac{R_2}{R_S + R_1}\right) \cdot \sqrt{(e_N)^2 + (e_{R_1 + R_S \parallel R_2})^2 + \left(i_N \cdot \left[\frac{(R_S + R_1) \cdot R_2}{R_S + R_1 + R_2}\right]\right)^2} \quad [V_{RMS}]$$

$$(7) \quad e_{R_1 + R_S \parallel R_2} = \sqrt{4 \cdot k_B \cdot T(K) \cdot \left[\frac{(R_S + R_1) \cdot R_2}{R_S + R_1 + R_2}\right]} \quad \left[\frac{V}{\sqrt{Hz}}\right] \quad \text{Thermal noise of } (R_1 + R_S) \parallel R_2$$

$$(8) \quad k_B = 1.38065 \cdot 10^{-23} \quad \left[\frac{J}{K}\right] \quad \text{Boltzmann Constant}$$

$$(9) \quad T(K) = 237.15 + T(^{\circ}C) \quad [K] \quad \text{Temperature in kelvins}$$

Copyright © 2017, Texas Instruments Incorporated

Where:  $e_N$  is the voltage noise of the amplifier. For the OPAx145 operational amplifier,  $e_N = 7 \text{ nV} / \sqrt{\text{Hz}}$  at 1 kHz.

Where:  $i_N$  is the current noise of the amplifier. For the OPAx145 operational amplifier,  $i_N = 0.8 \text{ fA} / \sqrt{\text{Hz}}$  at 1 kHz.

NOTE: For additional resources on noise calculations visit [TI's Precision Labs Series](#).

**Figure 7-2. Noise Calculation in Gain Configurations**

### 7.3.5 Phase-Reversal Protection

The OPAx145 has internal phase-reversal protection. Many FET-input and bipolar-input op amps exhibit a phase reversal when the input is driven beyond its linear common-mode range. This condition is most often encountered in noninverting circuits when the input is driven beyond the specified common-mode voltage range, causing the output to reverse into the opposite rail. The input circuitry of the OPAx145 prevents phase reversal with excessive common-mode voltage; instead, the output limits into the appropriate rail (see [Figure 6-28](#)).

### 7.3.6 Electrical Overstress

Designers often ask questions about the capability of an operational amplifier to withstand electrical overstress. These questions tend to focus on the device inputs, but may involve the supply voltage pins or even the output pin. Each of these different pin functions have electrical stress limits determined by the voltage breakdown characteristics of the particular semiconductor fabrication process and specific circuits connected to the pin. Additionally, internal electrostatic discharge (ESD) protection is built into these circuits to protect them from accidental ESD events both before and during product assembly.

A good understanding of this basic ESD circuitry and its relevance to an electrical overstress event is helpful. See [Figure 7-3](#) for an illustration of the ESD circuits contained in the OPAx145 (indicated by the dashed line area). The ESD protection circuitry involves several current-steering diodes connected from the input and output pins and routed back to the internal power-supply lines, where the power supply is connected to an absorption device internal to the operational amplifier. This protection circuitry is intended to remain inactive during normal circuit operation.

An ESD event produces a short duration, high-voltage pulse that is transformed into a short duration, high-current pulse that discharges through a semiconductor device. The ESD protection circuits are designed to provide a current path around the operational amplifier core to prevent the amplifier from being damaged. The energy absorbed by the protection circuitry is then dissipated as heat.

When an ESD voltage develops across two or more of the amplifier device pins, current flows through one or more of the steering diodes. Depending on the path that the current takes, the absorption device may activate. The absorption device has a trigger, or threshold voltage, that is greater than the normal operating voltage of the OPAx145 but less than the device breakdown voltage level. After this threshold is exceeded, the absorption device quickly activates and clamps the voltage across the supply rails to a safe level.

When the operational amplifier connects into a circuit, such as the one [Figure 7-3](#) shows, the ESD protection components are intended to remain inactive and not become involved in the application circuit operation. However, circumstances may arise where an applied voltage exceeds the operating voltage range of a given pin. If this condition occurs, there is a risk that some of the internal ESD protection circuits may be biased on, and conduct current. Any such current flow occurs through steering diode paths and rarely involves the absorption device.

[Figure 7-3](#) depicts a specific example where the input voltage,  $V_{IN}$ , exceeds the positive supply voltage ( $+V_S$ ) by 500 mV or more. Much of what happens in the circuit depends on the supply characteristics. If  $+V_S$  can sink the current, one of the upper input steering diodes conducts and directs current to  $+V_S$ . Excessively high current levels can flow with increasingly higher  $V_{IN}$ . As a result, the data sheet specifications recommend that applications limit the input current to 10 mA.

If the supply is not capable of sinking the current,  $V_{IN}$  may begin sourcing current to the operational amplifier, and then take over as the source of positive supply voltage. The danger in this case is that the voltage can rise to levels that exceed the operational amplifier absolute maximum ratings.

Another common question involves what happens to the amplifier if an input signal is applied to the input while the power supplies  $+V_S$  or  $-V_S$  are at 0 V. The answer depends on the supply characteristic while at 0 V, or at a level less than the input signal amplitude. If the supplies appear as high impedance, then the operational amplifier supply current may be supplied by the input source through the current steering diodes. This state is not a normal bias condition; the amplifier most likely will not operate normally. If the supplies are low impedance, then the current through the steering diodes can become quite high. The current level depends on the ability of the input source to deliver current, and any resistance in the input path.

If there is an uncertainty about the ability of the supply to absorb this current, external Zener diodes may be added to the supply pins as shown in [Figure 7-3](#). The Zener voltage must be selected so that the diode does not turn on during normal operation. However, the Zener voltage must be low enough so that the Zener diode conducts if the supply pin begins to rise above the safe operating supply voltage level.

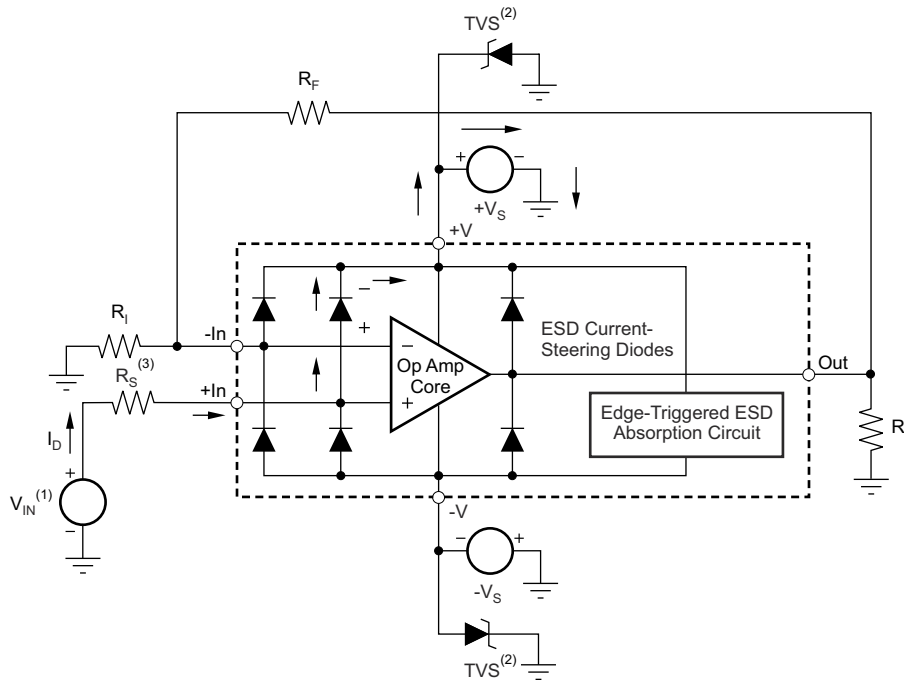

- (1)  $V_{IN} = +V_S + 500 \text{ mV}$ .
- (2) TVS:  $+V_{S(max)} > V_{TVSBR (Min)} > +V_S$
- (3) Suggested value approximately  $1 \text{ k}\Omega$ .

**图 7-3. Equivalent Internal ESD Circuitry Relative to a Typical Circuit Application**

### 7.3.7 EMI Rejection

The electromagnetic interference (EMI) rejection ratio, or EMIRR, describes the EMI immunity of operational amplifiers. An adverse effect that is common to many op amps is a change in the offset voltage as a result of RF signal rectification. An op amp that is more efficient at rejecting this change in offset as a result of EMI has a higher EMIRR and is quantified by a decibel value. Measuring EMIRR can be performed in many ways, but this section provides the EMIRR IN+, which specifically describes the EMIRR performance when the RF signal is applied to the noninverting input pin of the op amp. In general, only the noninverting input is tested for EMIRR for the following three reasons:

- Op amp input pins are known to be the most sensitive to EMI, and typically rectify RF signals better than the supply or output pins.
- The noninverting and inverting op amp inputs have symmetrical physical layouts and exhibit nearly matching EMIRR performance.
- EMIRR is easier to measure on noninverting pins than on other pins because the noninverting input terminal can be isolated on a PCB. This isolation allows the RF signal to be applied directly to the noninverting input terminal with no complex interactions from other components or connecting PCB traces.

High-frequency signals conducted or radiated to any pin of the operational amplifier result in adverse effects, as the amplifier would not have sufficient loop gain to correct for signals with spectral content outside the amplifier bandwidth. Conducted or radiated EMI on inputs, power supply, or output may result in unexpected dc offsets, transient voltages, or other unknown behavior. Be sure to properly shield and isolate sensitive analog nodes from noisy radio signals and digital clocks and interfaces. 图 7-5 shows the effect of conducted EMI to the power supplies on the input offset voltage of OPAX145.

The EMIRR IN+ of the OPAX145 is plotted versus frequency as shown in 图 7-4. The OPAX145 unity-gain bandwidth is 5.5 MHz. EMIRR performance below this frequency denotes interfering signals that fall within the op amp bandwidth. See *EMI Rejection Ratio of Operational Amplifiers*, available for download from [www.ti.com](http://www.ti.com).



表 7-1 lists the EMIRR IN+ values for the OPAx145 at particular frequencies commonly encountered in real-world applications. Applications listed in 表 7-1 may be centered on or operated near the particular frequency shown. This information may be of special interest to designers working with these types of applications, or working in other fields likely to encounter RF interference from broad sources, such as the industrial, scientific, and medical (ISM) radio band.

表 7-1. OPAx145 EMIRR IN+ for Frequencies of Interest

FREQUENCY	APPLICATION OR ALLOCATION	EMIRR IN+
400 MHz	Mobile radio, mobile satellite, space operation, weather, radar, ultra-high frequency (UHF) applications	54 dB
900 MHz	Global system for mobile communications (GSM) applications, radio communication, navigation, GPS (to 1.6 GHz), GSM, aeronautical mobile, UHF applications	68 dB
1.8 GHz	GSM applications, mobile personal communications, broadband, satellite, L-band (1 GHz to 2 GHz)	86 dB
2.4 GHz	802.11b, 802.11g, 802.11n, Bluetooth®, mobile personal communications, industrial, scientific and medical (ISM) radio band, amateur radio and satellite, S-band (2 GHz to 4 GHz)	107 dB
3.6 GHz	Radiolocation, aero communication and navigation, satellite, mobile, S-band	100 dB
5 GHz	802.11a, 802.11n, aero communication and navigation, mobile communication, space and satellite operation, C-band (4 GHz to 8 GHz)	105 dB

### 7.3.8 EMIRR +IN Test Configuration

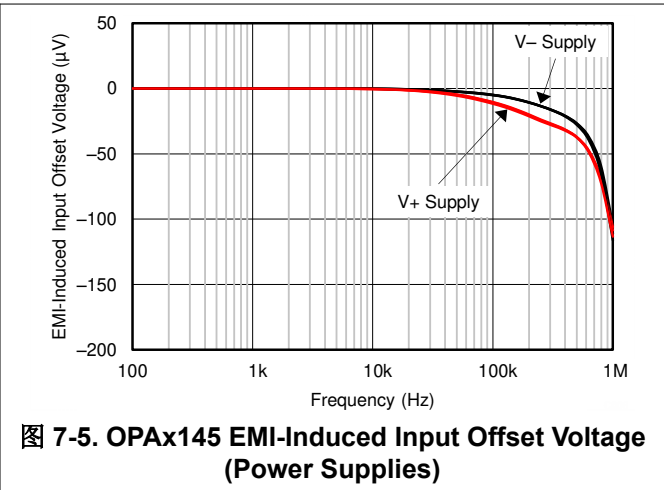
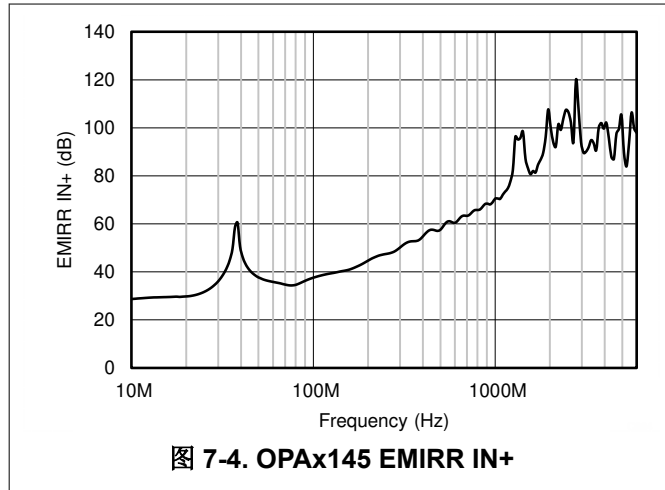
图 7-6 shows the circuit configuration for testing the EMIRR IN+. An RF source is connected to the op amp noninverting input terminal using a transmission line. The op amp is configured in a unity-gain buffer topology with the output connected to a low-pass filter (LPF) and a digital multimeter (DMM). A large impedance mismatch at the op amp input causes a voltage reflection; however, this effect is characterized and accounted for when determining the EMIRR IN+. The resulting DC offset voltage is sampled and measured by the multimeter. The LPF isolates the multimeter from residual RF signals that may interfere with multimeter accuracy.



图 7-6. EMIRR +IN Test Configuration

## 7.4 Device Functional Modes

The OPAx145 has a single functional mode and is operational when the power-supply voltage is greater than 4.5 V ( $\pm 2.25$  V). The maximum power supply voltage for the OPAx145 is 36 V ( $\pm 18$  V).

## 8 Application and Implementation

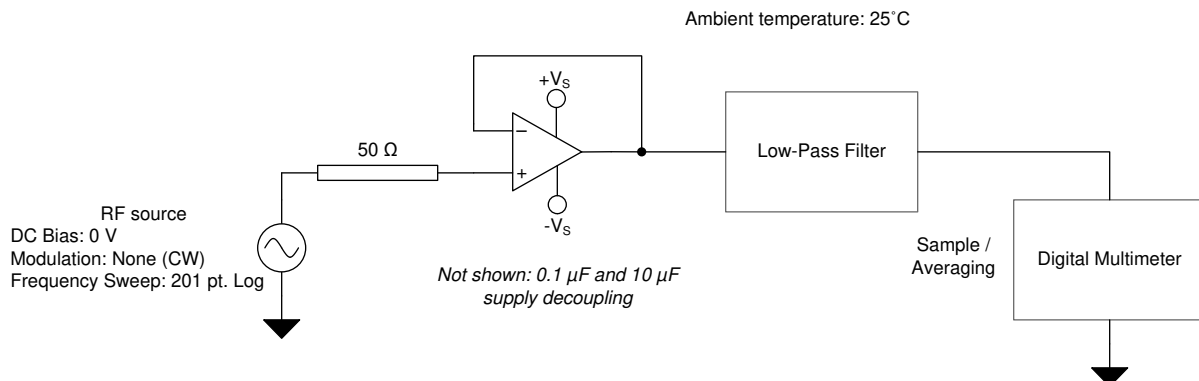
### 备注

以下应用部分中的信息不属于 TI 器件规格的范围，TI 不担保其准确性和完整性。TI 的客户应负责确定器件是否适用于其应用。客户应验证并测试其设计，以确保系统功能。

### 8.1 Application Information

The OPAx145 are unity-gain stable operational amplifiers with low noise, low input-bias current, and low input-offset voltage. Applications with noisy or high-impedance power supplies require decoupling capacitors placed close to the device pins. In most cases, 0.1- $\mu$ F capacitors are adequate. Designers can easily use the rail-to-rail output swing and input range that includes  $V^-$  to take advantage of the low-noise characteristics of JFET amplifiers while also interfacing to modern, single-supply, precision data converters.

### 8.2 Typical Application

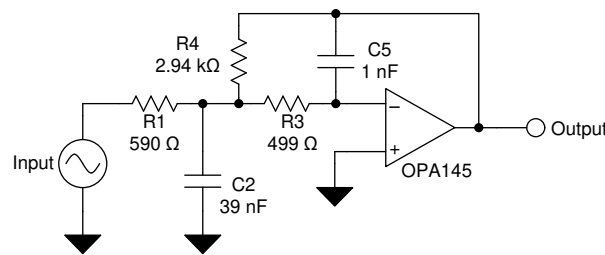

Copyright © 2017, Texas Instruments Incorporated

图 8-1. 25-kHz Low-Pass Filter

#### 8.2.1 Design Requirements

Low-pass filters are commonly employed in signal processing applications to reduce noise and prevent aliasing. The OPAx145 are designed to construct high-speed, high-precision active filters. 图 8-1 shows a second-order, low-pass filter commonly encountered in signal processing applications.

Use the following parameters for this design example:

- Gain = 5 V/V (inverting gain)
- Low-pass cutoff frequency = 25 kHz
- Second-order Chebyshev filter response with 3-dB gain peaking in the passband

#### 8.2.2 Detailed Design Procedure

The infinite-gain multiple-feedback circuit for a low-pass network function is shown in 图 8-1. Use 方程式 2 to calculate the voltage transfer function.

$$\frac{\text{Output}}{\text{Input}}(s) = \frac{-1/R_1 R_3 C_2 C_5}{s^2 + (s/C_2)(1/R_1 + 1/R_3 + 1/R_4) + 1/R_3 R_4 C_2 C_5} \quad (2)$$

This circuit produces a signal inversion. For this circuit, the gain at dc and the low-pass cutoff frequency are calculated by 方程式 3:

$$\text{Gain} = \frac{R_4}{R_1}$$

$$f_c = \frac{1}{2\pi} \sqrt{(1/R_3 R_4 C_2 C_5)} \quad (3)$$

For systems which have different filter parameters or require specific system optimization, such as minimizing the system noise, an alternative device may be desired. A list of recommended alternatives can be found in 表 8-1.

表 8-1. Alternative Devices

FEATURES	PRODUCT
Low-power, 10-MHz FET input industrial op amp	OPA140
2.2-nV/√Hz, low-power, 36-V op amp in SOT-23 package	OPA209
Low-noise, high-precision, 22-MHz, 4-nV/√Hz JFET-input op amp	OPA827
Low-noise, low I <sub>Q</sub> precision CMOS op amp	OPA376
Low-power, precision, CMOS, rail-to-rail input/output, low-offset, low-bias op amp	OPA191

Software tools are readily available to simplify filter design. WEBENCH® Filter Designer is a simple, powerful, and easy-to-use active filter design program. The WEBENCH® Filter Designer lets designers create optimized filter designs using a selection of TI operational amplifiers and passive components from TI's vendor partners.

Available as a web based tool from the WEBENCH Design Center, WEBENCH Filter Designer allows designers to design, optimize, and simulate complete multistage active filter solutions within minutes.

### 8.2.3 Application Curve



图 8-2. OPAx145 Second-Order, 25-kHz, Chebyshev, Low-Pass Filter

## 8.3 System Examples

### 8.3.1 16-Bit, 100-kSPS, Fully Differential Transimpedance Imaging and Measurement

The OPAx145 are used in a differential transimpedance (I-V) measurement application capable of driving the ADS8867, a 16-bit, microPower, truly-differential ADC, at its maximum conversion rate of 100 kSPS with an acquisition time of 1200 ns and conversion time of 8800 ns. The first stage supports a forward bandwidth of 493.5 kHz with 100 kΩ of transimpedance gain, enabling the photodiode to fully charge and settle to ±38 μV (±1/2 LSB on 5-V ADC reference voltage) within the conversion time of the ADC. The differential nature of the system provides several advantages such as double the transimpedance gain compared to a single-ended system, improved signal-to-noise ratio, easy interfacing to high-precision, fully-differential ADCs, and additional protection against inductively-coupled noise and interference. Additionally, capacitively-coupled common-mode transients can be minimized using low-impedance termination resistors R<sub>TERM1</sub> and R<sub>TERM2</sub>.

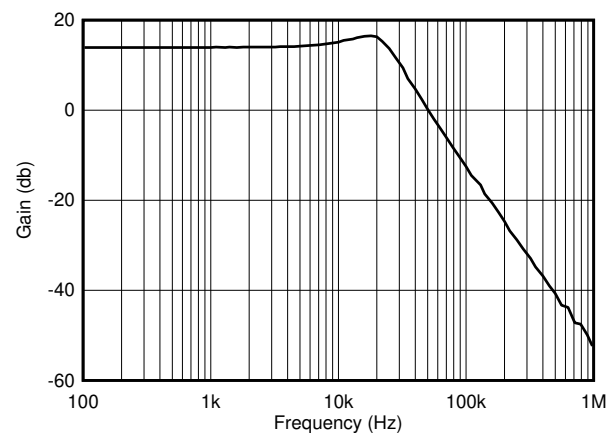
The second stage provides the reverse bandwidth required for settling to 16-bit accuracy after the internal sampling capacitor of the successive-approximation-register (SAR) ADC is connected to the second stage. The two OPAx145 amplifiers in the second stage are configured as buffers for maximum closed-loop bandwidth, and their stability is optimized using R3, C3 and R4, C4 by creating a snubber that reduces the open-loop output impedance (see 图 6-26). C5 and C6 are provided as a charge reservoir for the internal sampling capacitor of the ADC, and R5 and R6 are tuned to optimize the phase margin of the second stage to drive the output



capacitance. This two-stage approach enables compatibility with a wide selection of high output-impedance sensors while still maintaining 16-bit settling performance. Furthermore, the first stage can be designed with sufficient phase margin to drive twisted-pair transmission lines in remote measurement systems. Proper design of the transmission line reduces the interference of other signals over long distances. Figure 8-4 shows the settling performance of the system described previously and in Figure 8-3 — the settling time during the acquisition cycle is shown for settling successfully to 0  $\mu\text{A}$  from 5  $\mu\text{s}$  to 6.2  $\mu\text{s}$ . At 6.3  $\mu\text{s}$ , the photodiode current is changed to 5  $\mu\text{A}$  (full-scale) and settles during the conversion cycle of the ADC (6.2  $\mu\text{s}$  to 15  $\mu\text{s}$ ), and is then acquired successfully from 15  $\mu\text{s}$  to 16.2  $\mu\text{s}$ .



图 8-3. 16-bit, 100-kSPS, Fully Differential Transimpedance Schematic



图 8-4. 16-bit, 100-kSPS, Fully Differential Transimpedance Settling Performance

## 9 Power Supply Recommendations

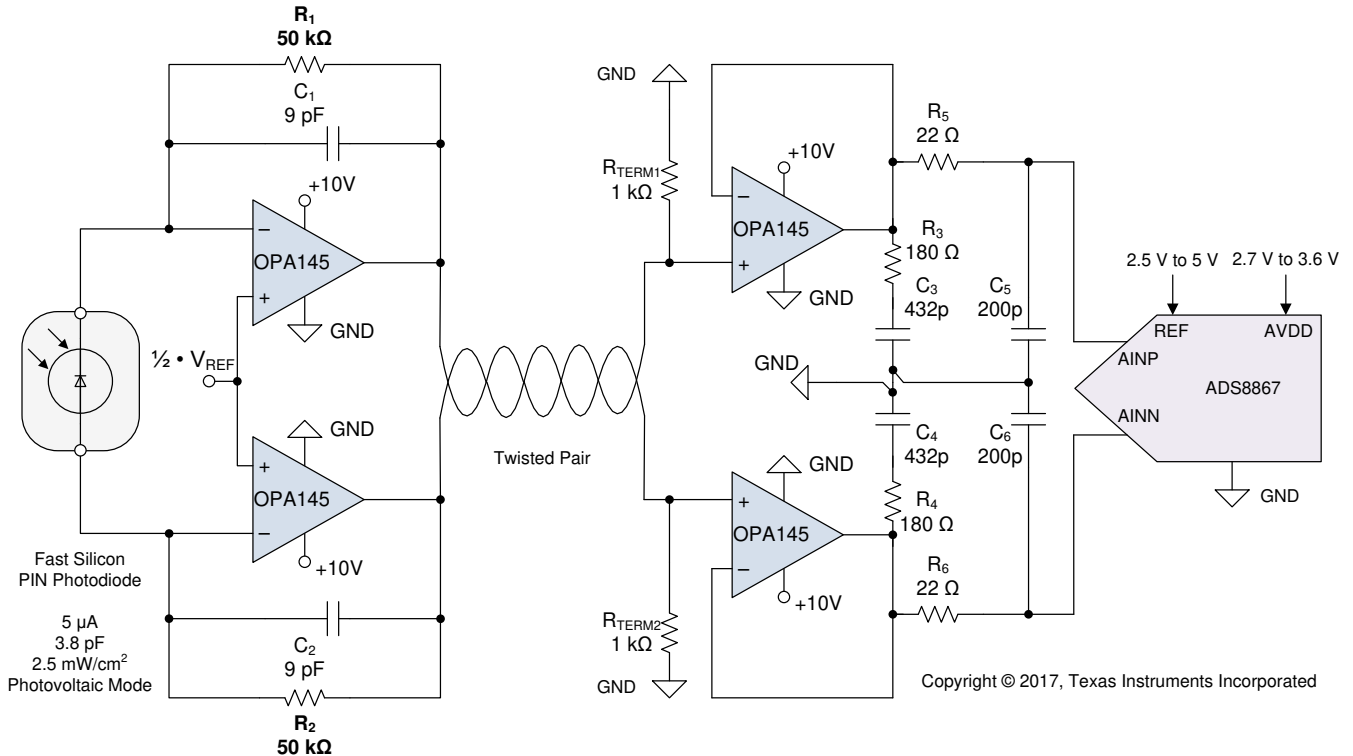
The OPAx145 are specified for operation from 4.5 V to 36 V ( $\pm 2.25$  V to  $\pm 18$  V); many specifications apply from  $-40^{\circ}\text{C}$  to  $+125^{\circ}\text{C}$ . Parameters that can exhibit significant variance with regard to operating voltage or temperature are presented in [# 6.7](#).

### CAUTION

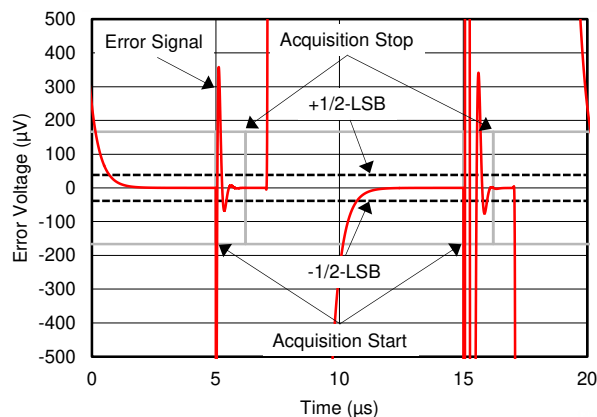
Supply voltages larger than 40 V can permanently damage the device; see [# 6.1](#)

Place 0.1- $\mu\text{F}$  bypass capacitors close to the power-supply pins to reduce errors coupling in from noisy or high-impedance power supplies. For more detailed information on bypass capacitor placement, see [# 10](#).

## 10 Layout

### 10.1 Layout Guidelines

For best operational performance of the device, use good PCB layout practices, including:

- Noise can propagate into analog circuitry through the power pins of the circuit as a whole and the op amp itself. Bypass capacitors are used to reduce the coupled noise by providing low-impedance power sources local to the analog circuitry.
  - Connect low-ESR, 0.1- $\mu\text{F}$  ceramic bypass capacitors between each supply pin and ground, placed as close as possible to the device. A single bypass capacitor from V+ to ground is applicable for single-supply applications.
- Separate grounding for analog and digital portions of circuitry is one of the simplest and most effective methods of noise suppression. One or more layers on multilayer PCBs are usually devoted to ground planes. A ground plane helps distribute heat and reduces EMI noise pickup. Make sure to physically separate digital and analog grounds paying attention to the flow of the ground current. For more detailed information, see [The PCB is a component of op amp design technical brief](#).
- To reduce parasitic coupling, run the input traces as far away as possible from the supply or output traces. If these traces cannot be kept separate, crossing the sensitive trace perpendicular is much better as opposed to in parallel with the noisy trace.
- Place the external components as close as possible to the device. As illustrated in [Figure 10-1](#), keeping RF and RG close to the inverting input minimizes parasitic capacitance.
- Keep the length of input traces as short as possible. Always remember that the input traces are the most sensitive part of the circuit.
- Consider a driven, low-impedance guard ring around the critical traces. A guard ring can significantly reduce leakage currents from nearby traces that are at different potentials.
- For best performance, TI recommends cleaning the PCB following board assembly.
- Any precision integrated circuit may experience performance shifts due to moisture ingress into the plastic package. Following any aqueous PCB cleaning process, TI recommends baking the PCB assembly to remove moisture introduced into the device packaging during the cleaning process. A low temperature, post cleaning bake at  $85^{\circ}\text{C}$  for 30 minutes is sufficient for most circumstances.

## 10.2 Layout Example

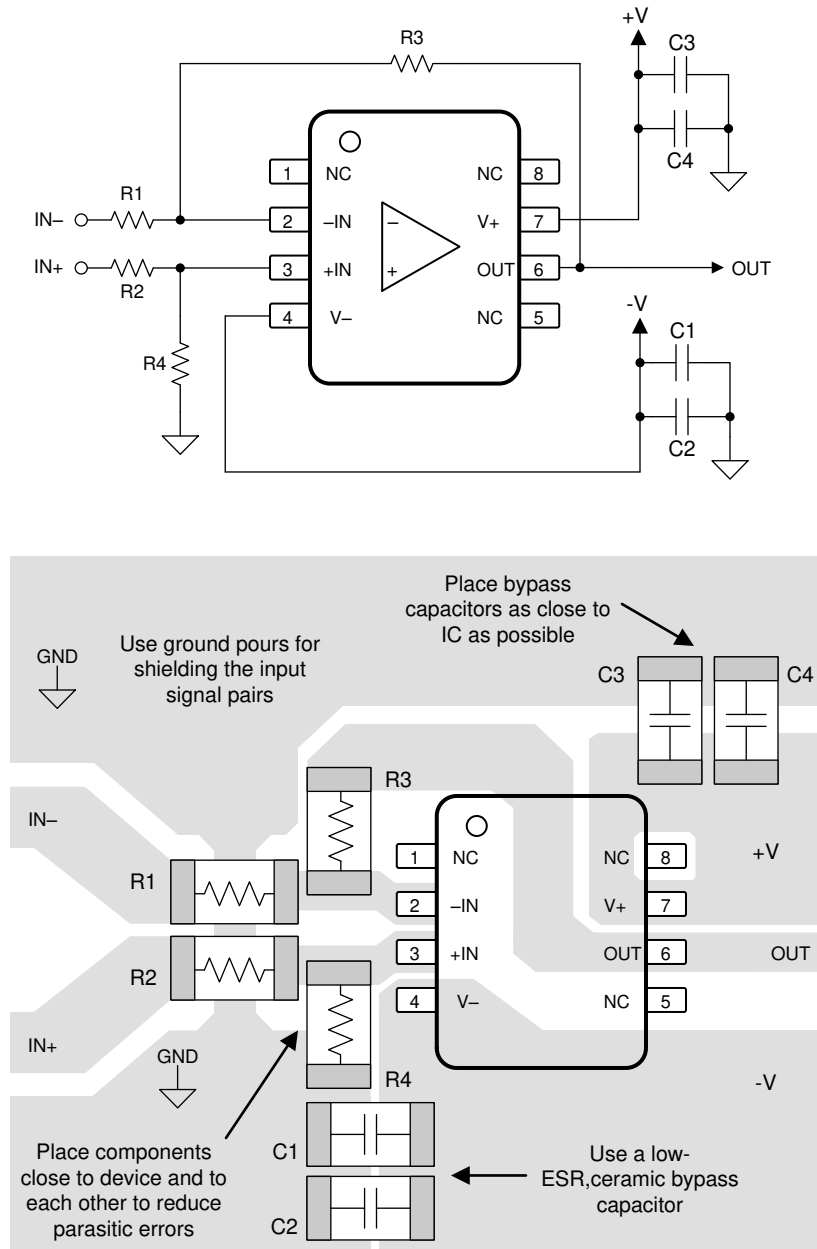

Copyright © 2017, Texas Instruments Incorporated

**图 10-1. Operational Amplifier Board Layout for Difference Amplifier Configuration**

## 11 Device and Documentation Support

### 11.1 Device Support

#### 11.1.1 Development Support

##### 11.1.1.1 TINA-TI™ Simulation Software (Free Download)

TINA™ is a simple, powerful, and easy-to-use circuit simulation program based on a SPICE engine. TINA-TI™ simulation software is a free, fully functional version of the TINA software, preloaded with a library of macro models in addition to a range of both passive and active models. TINA-TI software provides all the conventional dc, transient, and frequency domain analysis of SPICE, as well as additional design capabilities.

Available as a [free download](#) from the Analog eLab Design Center, TINA-TI simulation software offers extensive post-processing capability that allows users to format results in a variety of ways. Virtual instruments offer the ability to select input waveforms and probe circuit nodes, voltages, and waveforms, creating a dynamic quick-start tool.

---

#### 备注

These files require that either the TINA software (from DesignSoft™) or TINA-TI software be installed. Download the free TINA-TI software from the [TINA-TI folder](#).

---

##### 11.1.1.2 WEBENCH Filter Designer Tool

[WEBENCH® Filter Designer](#) is a simple, powerful, and easy-to-use active filter design program. The WEBENCH Filter Designer lets you create optimized filter designs using a selection of TI operational amplifiers and passive components from TI's vendor partners.

##### 11.1.1.3 TI Precision Designs

TI Precision Designs are available online at <http://www.ti.com/ww/en/analog/precision-designs/>. TI Precision Designs are analog solutions created by TI's precision analog applications experts and offer the theory of operation, component selection, simulation, complete PCB schematic and layout, bill of materials, and measured performance of many useful circuits.

### 11.2 Documentation Support

#### 11.2.1 Related Documentation

For related documentation see the following:

- Texas Instruments, [The PCB is a component of op amp design](#)
- Texas Instruments, [OPA140, OPA2140, OPA4140 EMI Immunity Performance](#)
- Texas Instruments, [Compensate Transimpedance Amplifiers Intuitively](#)
- Texas Instruments, [Operational amplifier gain stability, Part 3: AC gain-error analysis](#)
- Texas Instruments, [Operational amplifier gain stability, Part 2: DC gain-error analysis](#)
- Texas Instruments, [Using infinite-gain, MFB filter topology in fully differential active filters](#)
- Texas Instruments, [Op Amp Performance Analysis](#)
- Texas Instruments, [Single-Supply Operation of Operational Amplifiers](#)
- Texas Instruments, [Tuning in Amplifiers](#)
- Texas Instruments, [Shelf-Life Evaluation of Lead-Free Component Finishes](#)
- Texas Instruments, [Feedback Plots Define Op Amp AC Performance](#)
- Texas Instruments, [EMI Rejection Ratio of Operational Amplifiers](#)

### 11.3 Receiving Notification of Documentation Updates

To receive notification of documentation updates, navigate to the device product folder on ti.com. In the upper right corner, click on *Alert me* to register and receive a weekly digest of any product information that has changed. For change details, review the revision history included in any revised document.

## 11.4 支持资源

TI E2E™ 支持论坛是工程师的重要参考资料，可直接从专家获得快速、经过验证的解答和设计帮助。搜索现有解答或提出自己的问题可获得所需的快速设计帮助。

链接的内容由各个贡献者“按原样”提供。这些内容并不构成 TI 技术规范，并且不一定反映 TI 的观点；请参阅 TI 的《使用条款》。

## 11.5 Trademarks

TINA™ and DesignSoft™ are trademarks of DesignSoft, Inc.  
TINA-TI™ and TI E2E™ are trademarks of Texas Instruments.  
Bluetooth® is a registered trademark of Bluetooth SIG, Inc.  
WEBENCH® is a registered trademark of Texas Instruments.  
所有商标均为其各自所有者的财产。

## 11.6 静电放电警告



静电放电 (ESD) 会损坏这个集成电路。德州仪器 (TI) 建议通过适当的预防措施处理所有集成电路。如果不遵守正确的处理和安装程序，可能会损坏集成电路。

ESD 的损坏小至导致微小的性能降级，大至整个器件故障。精密的集成电路可能更容易受到损坏，这是因为非常细微的参数更改都可能会导致器件与其发布的规格不相符。

## 11.7 术语表

**TI 术语表** 本术语表列出并解释了术语、首字母缩略词和定义。

## 12 Mechanical, Packaging, and Orderable Information

The following pages include mechanical, packaging, and orderable information. This information is the most current data available for the designated devices. This data is subject to change without notice and revision of this document. For browser-based versions of this data sheet, refer to the left-hand navigation.

**PACKAGING INFORMATION**

Orderable Device	Status (1)	Package Type	Package Drawing	Pins	Package Qty	Eco Plan (2)	Lead finish/ Ball material (6)	MSL Peak Temp (3)	Op Temp (°C)	Device Marking (4/5)	Samples
OPA145ID	ACTIVE	SOIC	D	8	75	RoHS & Green	NIPDAU	Level-2-260C-1 YEAR	-40 to 125	OPA145	<a href="#">Samples</a>
OPA145IDBVR	ACTIVE	SOT-23	DBV	5	3000	RoHS & Green	NIPDAU	Level-2-260C-1 YEAR	-40 to 125	11B2	<a href="#">Samples</a>
OPA145IDBVT	ACTIVE	SOT-23	DBV	5	250	RoHS & Green	NIPDAU	Level-2-260C-1 YEAR	-40 to 125	11B2	<a href="#">Samples</a>
OPA145IDGKR	ACTIVE	VSSOP	DGK	8	2500	RoHS & Green	NIPDAUAG   SN	Level-2-260C-1 YEAR	-40 to 125	114Q	<a href="#">Samples</a>
OPA145IDGKT	ACTIVE	VSSOP	DGK	8	250	RoHS & Green	NIPDAUAG   SN	Level-2-260C-1 YEAR	-40 to 125	114Q	<a href="#">Samples</a>
OPA145IDR	ACTIVE	SOIC	D	8	2500	RoHS & Green	NIPDAU	Level-2-260C-1 YEAR	-40 to 125	OPA145	<a href="#">Samples</a>
OPA2145IDGKR	ACTIVE	VSSOP	DGK	8	2500	RoHS & Green	NIPDAU	Level-2-260C-1 YEAR	-40 to 125	2BQJ	<a href="#">Samples</a>
OPA2145IDGKT	ACTIVE	VSSOP	DGK	8	250	RoHS & Green	NIPDAU	Level-2-260C-1 YEAR	-40 to 125	2BQJ	<a href="#">Samples</a>
OPA2145IDR	ACTIVE	SOIC	D	8	2500	RoHS & Green	NIPDAU	Level-2-260C-1 YEAR	-40 to 125	OP2145	<a href="#">Samples</a>

(1) The marketing status values are defined as follows:

**ACTIVE:** Product device recommended for new designs.

**LIFEBUY:** TI has announced that the device will be discontinued, and a lifetime-buy period is in effect.

**NRND:** Not recommended for new designs. Device is in production to support existing customers, but TI does not recommend using this part in a new design.

**PREVIEW:** Device has been announced but is not in production. Samples may or may not be available.

**OBSOLETE:** TI has discontinued the production of the device.

(2) **RoHS:** TI defines "RoHS" to mean semiconductor products that are compliant with the current EU RoHS requirements for all 10 RoHS substances, including the requirement that RoHS substance do not exceed 0.1% by weight in homogeneous materials. Where designed to be soldered at high temperatures, "RoHS" products are suitable for use in specified lead-free processes. TI may reference these types of products as "Pb-Free".

**RoHS Exempt:** TI defines "RoHS Exempt" to mean products that contain lead but are compliant with EU RoHS pursuant to a specific EU RoHS exemption.

**Green:** TI defines "Green" to mean the content of Chlorine (Cl) and Bromine (Br) based flame retardants meet JS709B low halogen requirements of <=1000ppm threshold. Antimony trioxide based flame retardants must also meet the <=1000ppm threshold requirement.

(3) MSL, Peak Temp. - The Moisture Sensitivity Level rating according to the JEDEC industry standard classifications, and peak solder temperature.

(4) There may be additional marking, which relates to the logo, the lot trace code information, or the environmental category on the device.

(5) Multiple Device Markings will be inside parentheses. Only one Device Marking contained in parentheses and separated by a "~" will appear on a device. If a line is indented then it is a continuation of the previous line and the two combined represent the entire Device Marking for that device.

(6) Lead finish/Ball material - Orderable Devices may have multiple material finish options. Finish options are separated by a vertical ruled line. Lead finish/Ball material values may wrap to two lines if the finish value exceeds the maximum column width.

**Important Information and Disclaimer:**The information provided on this page represents TI's knowledge and belief as of the date that it is provided. TI bases its knowledge and belief on information provided by third parties, and makes no representation or warranty as to the accuracy of such information. Efforts are underway to better integrate information from third parties. TI has taken and continues to take reasonable steps to provide representative and accurate information but may not have conducted destructive testing or chemical analysis on incoming materials and chemicals. TI and TI suppliers consider certain information to be proprietary, and thus CAS numbers and other limited information may not be available for release.

In no event shall TI's liability arising out of such information exceed the total purchase price of the TI part(s) at issue in this document sold by TI to Customer on an annual basis.

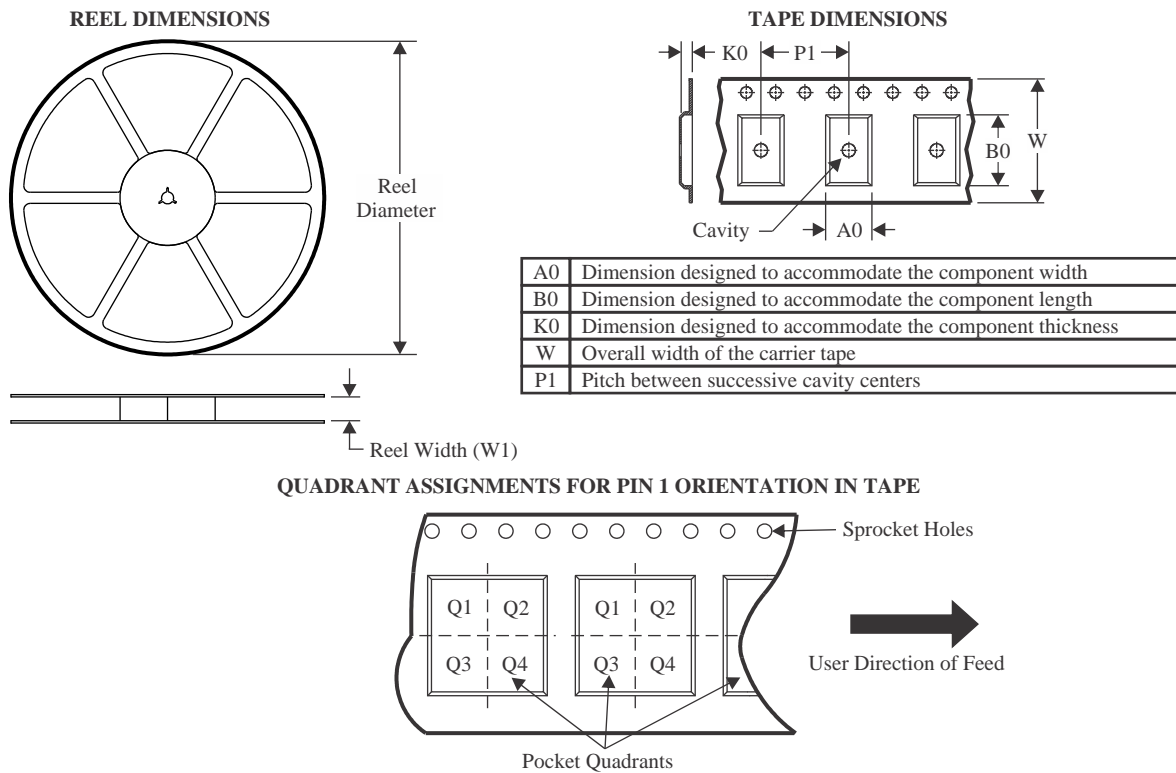
**TAPE AND REEL INFORMATION**

\*All dimensions are nominal

Device	Package Type	Package Drawing	Pins	SPQ	Reel Diameter (mm)	Reel Width W1 (mm)	A0 (mm)	B0 (mm)	K0 (mm)	P1 (mm)	W (mm)	Pin1 Quadrant
OPA145IDBVR	SOT-23	DBV	5	3000	180.0	8.4	3.23	3.17	1.37	4.0	8.0	Q3
OPA145IDBVT	SOT-23	DBV	5	250	180.0	8.4	3.23	3.17	1.37	4.0	8.0	Q3
OPA145IDGKR	VSSOP	DGK	8	2500	330.0	12.4	5.3	3.4	1.4	8.0	12.0	Q1
OPA145IDGKT	VSSOP	DGK	8	250	330.0	12.4	5.3	3.4	1.4	8.0	12.0	Q1
OPA145IDR	SOIC	D	8	2500	330.0	12.4	6.4	5.2	2.1	8.0	12.0	Q1
OPA2145IDGKR	VSSOP	DGK	8	2500	330.0	12.4	5.3	3.4	1.4	8.0	12.0	Q1
OPA2145IDGKT	VSSOP	DGK	8	250	180.0	12.4	5.3	3.4	1.4	8.0	12.0	Q1
OPA2145IDR	SOIC	D	8	2500	330.0	12.4	6.4	5.2	2.1	8.0	12.0	Q1



**TAPE AND REEL BOX DIMENSIONS**

\*All dimensions are nominal

Device	Package Type	Package Drawing	Pins	SPQ	Length (mm)	Width (mm)	Height (mm)
OPA145IDBVR	SOT-23	DBV	5	3000	213.0	191.0	35.0
OPA145IDBVT	SOT-23	DBV	5	250	213.0	191.0	35.0
OPA145IDGKR	VSSOP	DGK	8	2500	366.0	364.0	50.0
OPA145IDGKT	VSSOP	DGK	8	250	366.0	364.0	50.0
OPA145IDR	SOIC	D	8	2500	356.0	356.0	35.0
OPA2145IDGKR	VSSOP	DGK	8	2500	356.0	356.0	35.0
OPA2145IDGKT	VSSOP	DGK	8	250	210.0	185.0	35.0
OPA2145IDR	SOIC	D	8	2500	356.0	356.0	35.0

**TUBE**

\*All dimensions are nominal

Device	Package Name	Package Type	Pins	SPQ	L (mm)	W (mm)	T (μm)	B (mm)
OPA145ID	D	SOIC	8	75	506.6	8	3940	4.32

# DBV0005A



# PACKAGE OUTLINE

SOT-23 - 1.45 mm max height

SMALL OUTLINE TRANSISTOR



4214839/H 09/2023

## NOTES:

1. All linear dimensions are in millimeters. Any dimensions in parenthesis are for reference only. Dimensioning and tolerancing per ASME Y14.5M.
2. This drawing is subject to change without notice.
3. Reference JEDEC MO-178.
4. Body dimensions do not include mold flash, protrusions, or gate burrs. Mold flash, protrusions, or gate burrs shall not exceed 0.25 mm per side.
5. Support pin may differ or may not be present.

# EXAMPLE BOARD LAYOUT

DBV0005A

SOT-23 - 1.45 mm max height

SMALL OUTLINE TRANSISTOR



LAND PATTERN EXAMPLE  
EXPOSED METAL SHOWN  
SCALE:15X

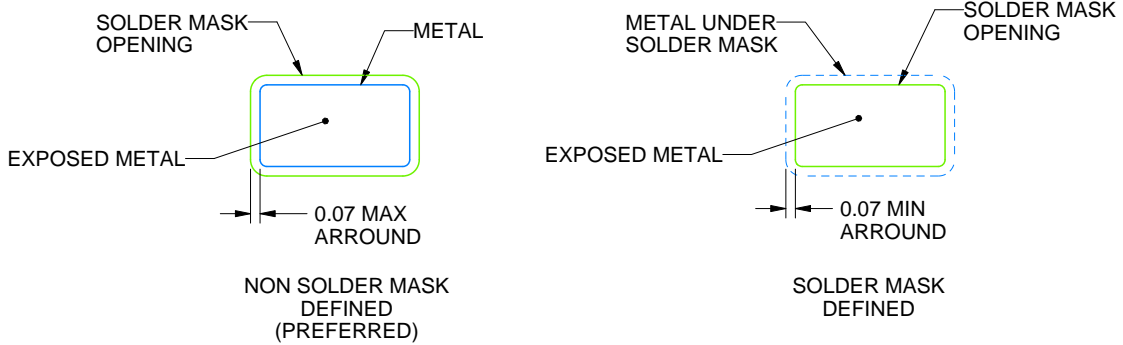

SOLDER MASK DETAILS

4214839/H 09/2023

NOTES: (continued)

- 6. Publication IPC-7351 may have alternate designs.
- 7. Solder mask tolerances between and around signal pads can vary based on board fabrication site.

# EXAMPLE STENCIL DESIGN

DBV0005A

SOT-23 - 1.45 mm max height

SMALL OUTLINE TRANSISTOR



SOLDER PASTE EXAMPLE  
BASED ON 0.125 mm THICK STENCIL  
SCALE:15X

4214839/H 09/2023

NOTES: (continued)

8. Laser cutting apertures with trapezoidal walls and rounded corners may offer better paste release. IPC-7525 may have alternate design recommendations.
9. Board assembly site may have different recommendations for stencil design.



D0008A

# PACKAGE OUTLINE

SOIC - 1.75 mm max height

SMALL OUTLINE INTEGRATED CIRCUIT



4214825/C 02/2019

### NOTES:

1. Linear dimensions are in inches [millimeters]. Dimensions in parenthesis are for reference only. Controlling dimensions are in inches. Dimensioning and tolerancing per ASME Y14.5M.
2. This drawing is subject to change without notice.
3. This dimension does not include mold flash, protrusions, or gate burrs. Mold flash, protrusions, or gate burrs shall not exceed  $.006$  [0.15] per side.
4. This dimension does not include interlead flash.
5. Reference JEDEC registration MS-012, variation AA.

# EXAMPLE BOARD LAYOUT

D0008A

SOIC - 1.75 mm max height

SMALL OUTLINE INTEGRATED CIRCUIT



LAND PATTERN EXAMPLE  
EXPOSED METAL SHOWN  
SCALE:8X



SOLDER MASK DETAILS

4214825/C 02/2019

NOTES: (continued)

6. Publication IPC-7351 may have alternate designs.

7. Solder mask tolerances between and around signal pads can vary based on board fabrication site.

# EXAMPLE STENCIL DESIGN

D0008A

SOIC - 1.75 mm max height

SMALL OUTLINE INTEGRATED CIRCUIT



SOLDER PASTE EXAMPLE  
BASED ON .005 INCH [0.125 MM] THICK STENCIL  
SCALE:8X

4214825/C 02/2019

NOTES: (continued)

8. Laser cutting apertures with trapezoidal walls and rounded corners may offer better paste release. IPC-7525 may have alternate design recommendations.
9. Board assembly site may have different recommendations for stencil design.



DGK (S-PDSO-G8)

PLASTIC SMALL-OUTLINE PACKAGE



- NOTES:
- A. All linear dimensions are in millimeters.
  - B. This drawing is subject to change without notice.
  - C. Body length does not include mold flash, protrusions, or gate burrs. Mold flash, protrusions, or gate burrs shall not exceed 0.15 per end.
  - D. Body width does not include interlead flash. Interlead flash shall not exceed 0.50 per side.
  - E. Falls within JEDEC MO-187 variation AA, except interlead flash.



- NOTES:
- A. All linear dimensions are in millimeters.
  - B. This drawing is subject to change without notice.
  - C. Publication IPC-7351 is recommended for alternate designs.
  - D. Laser cutting apertures with trapezoidal walls and also rounding corners will offer better paste release. Customers should contact their board assembly site for stencil design recommendations. Refer to IPC-7525 for other stencil recommendations.
  - E. Customers should contact their board fabrication site for solder mask tolerances between and around signal pads.

## 重要声明和免责声明

TI“按原样”提供技术和可靠性数据（包括数据表）、设计资源（包括参考设计）、应用或其他设计建议、网络工具、安全信息和其他资源，不保证没有瑕疵且不做任何明示或暗示的担保，包括但不限于对适销性、某特定用途方面的适用性或不侵犯任何第三方知识产权的暗示担保。

这些资源可供使用 TI 产品进行设计的熟练开发人员使用。您将自行承担以下全部责任：(1) 针对您的应用选择合适的 TI 产品，(2) 设计、验证并测试您的应用，(3) 确保您的应用满足相应标准以及任何其他功能安全、信息安全、监管或其他要求。

这些资源如有变更，恕不另行通知。TI 授权您仅可将这些资源用于研发本资源所述的 TI 产品的应用。严禁对这些资源进行其他复制或展示。您无权使用任何其他 TI 知识产权或任何第三方知识产权。您应全额赔偿因在这些资源的使用中对 TI 及其代表造成的任何索赔、损害、成本、损失和债务，TI 对此概不负责。

TI 提供的产品受 [TI 的销售条款](#) 或 [ti.com](#) 上其他适用条款/TI 产品随附的其他适用条款的约束。TI 提供这些资源并不会扩展或以其他方式更改 TI 针对 TI 产品发布的适用的担保或担保免责声明。

TI 反对并拒绝您可能提出的任何其他或不同的条款。

邮寄地址：Texas Instruments, Post Office Box 655303, Dallas, Texas 75265

Copyright © 2023，德州仪器 (TI) 公司

单击下面可查看定价，库存，交付和生命周期等信息

[>>TI\(德州仪器\)](#)