

行业标准双路运算放大器

1 特性

- 3V 至 36V 的宽电源电压范围 (B、BA 版本)
- 静态电流 : 300 μ A/通道 (B、BA 版本)
- 单位增益带宽为 1.2 MHz (B、BA 版本)
- 共模输入电压范围包括接地, 支持近地直接感测
- 25°C 时的最大输入失调电压为 2 mV (BA 版本)
- 25°C 时的最大输入失调电压为 3 mV (A、B 版本)
- 内部射频和 EMI 滤波器 (B、BA 版本)
- 对于符合 MIL-PRF-38535 标准的产品, 所有参数均经过测试, 除非另有说明。对于所有其他产品, 生产流程不一定包含对所有参数的测试。

2 应用

- 商用网络和服务器电源单元
- 多功能打印机
- 电源和移动充电器
- 电机控制 : 交流感应、有刷直流、无刷直流、高压、低压、永磁和步进电机
- 台式计算机和主板
- 室内外空调
- 洗衣机、烘干机和冰箱
- 交流逆变器、串式逆变器、中央逆变器和变频器
- 不间断电源
- 电子销售点系统

3 说明

LM358B 和 LM2904B 器件是行业标准运算放大器 LM358 和 LM2904 的下一代版本, 其中包括两个高压 (36V) 运算放大器。这些器件为成本敏感型应用提供了卓越的价值, 其特性包括低偏移 (300 μ V, 典型值)、对地共模输入范围和高差分输入电压能力。

LM358B 和 LM2904B 运算放大器利用单位增益稳定性、更低的失调电压 (最大值为 3mV ; LM358BA 和

LM2904BA 的最大值为 2mV) 和更低的静态电流 (每个放大器为 300 μ A, 典型值) 等增强型特性简化了电路设计。高 ESD (2kV, HBM) 和集成 EMI 以及射频滤波器可支持将 LM358B 和 LM2904B 器件用于更严苛、更具环境挑战性的应用。

LM358B 和 LM2904B 放大器采用微型封装 (如 SOT23-8) , 以及行业标准封装 (包括 SOIC、TSSOP 和 VSSOP) 。

器件信息

器件型号 ⁽¹⁾	封装	封装尺寸 (标称值)
LM358B、LM358BA、LM2904B、LM2904BA、LM358、LM358A、LM2904、LM2904V、LM258、LM258A	SOIC (8)	4.90mm × 3.90mm
LM358B、LM358BA、LM2904B、LM2904BA、LM358、LM358A、LM2904、LM2904V	TSSOP (8)	3.00mm × 4.40mm
LM358B、LM358BA、LM2904B、LM2904BA、LM358、LM358A、LM2904、LM2904V、LM258、LM258A	VSSOP (8)	3.00mm × 3.00mm
LM358B、LM358BA、LM2904B、LM2904BA	SOT-23 (8)	2.90mm × 1.60mm
LM358、LM2904	SO (8)	5.20mm × 5.30mm
LM358、LM2904、LM358A、LM258、LM258A	PDIP (8)	9.81mm × 6.35mm
LM158、LM158A	CDIP (8)	9.60mm × 6.67mm
LM158、LM158A	LCCC (20)	8.89mm × 8.89mm

系列产品比较

技术规范	LM358B LM358BA	LM2904B LM2904BA	LM358 LM358A	LM2904	LM2904V LM2904AV	LM258 LM258A	LM158 LM158A	单位
电源电压	3 至 36	3 至 36	3 至 30	3 至 26	3 至 30	3 至 30	3 至 30	V
失调电压 (25°C 时的最大值)	± 3 ± 2	± 3 ± 2	± 7 ± 3	± 7	± 7 ± 2	± 5 ± 3	± 5 ± 2	mV
输入偏置电流 (典型值/最大值)	10/35	10/35	20/250 15/100	20/250	20/250	20/150 15/80	20/150 15/50	nA
增益带宽积	1.2	1.2	0.7	0.7	0.7	0.7	0.7	MHz
电源电流 (每通道的典型值)	0.3	0.3	0.35	0.35	0.35	0.35	0.35	mA
ESD (HBM)	2000	2000	500	500	500	500	500	V
工作环境温度	-40 至 85	-40 至 125	0 至 70	-40 至 125	-40 至 125	-25 至 85	-55 至 125	°C

(1) 如需了解所有可用封装, 请参阅数据表末尾的可订购产品附录。



内容

1 特性.....	1	8 详细说明.....	28
2 应用.....	1	8.1 概述.....	28
3 说明.....	1	8.2 功能方框图：LM358B、LM358BA、LM2904B、 LM2904BA.....	28
4 修订历史记录.....	2	8.3 特性说明.....	29
5 引脚配置和功能.....	4	8.4 器件功能模式.....	29
6 规格.....	5	9 应用和实现.....	30
6.1 绝对最大额定值.....	5	9.1 应用信息.....	30
6.2 ESD 等级.....	5	9.2 典型应用.....	30
6.3 建议运行条件.....	6	10 电源相关建议.....	31
6.4 热性能信息.....	6	11 布局.....	31
6.5 电气特性：LM358B 和 LM358BA.....	7	11.1 布局指南.....	31
6.6 电气特性：LM2904B 和 LM2904BA.....	10	11.2 布局示例.....	32
6.7 电气特性：LM358、LM358A.....	12	12 器件和文档支持.....	33
6.8 电气特性：LM2904、LM2904V.....	14	12.1 接收文档更新通知.....	33
6.9 电气特性：LM158、LM158A.....	15	12.2 支持资源.....	33
6.10 电气特性：LM258、LM258A.....	17	12.3 商标.....	33
6.11 典型特性：LM358B 和 LM2904B.....	18	12.4 Electrostatic Discharge Caution.....	33
6.12 典型特性：LM158、LM158A、LM258、 LM258A、LM358、LM358A、LM2904 和 LM2904V.....	25	12.5 术语表.....	33
7 参数测量信息.....	27	13 机械、封装和可订购信息.....	34

4 修订历史记录

注：以前版本的页码可能与当前版本的页码不同

Changes from Revision Z (July 2021) to Revision AA (March 2022) Page

• 在 <i>器件信息</i> 表中添加了 LM358BA 和 LM2904BA.....	1
• 向 <i>说明</i> 部分添加了 <i>系列比较表</i>	1
• 在 <i>ESD 等级表</i> 中，将 B 版本和 BA 版本的 ESD (CDM) 从 1kV 升高到 1.5kV.....	5
• 将 LM2904BA 在 $T_A = -40^{\circ}\text{C}$ 至 $+125^{\circ}\text{C}$ 范围内的输入失调电压最大值从 $\pm 2.5\text{mV}$ 更改为 $\pm 3.0\text{mV}$	10

Changes from Revision Y (February 2021) to Revision Z (July 2021) Page

• 删除了 <i>器件信息</i> 表中 LM358B 和 LM2904B SOT-23 (8) 封装的预发布标签.....	1
• 更新了 <i>热性能信息表</i> 中的 DDF (SOT-23) 封装.....	6
• 从 <i>器件和文档支持</i> 部分删除了 <i>相关链接</i>	33

Changes from Revision X (June 2020) to Revision Y (February 2021) Page

• 更新了整个文档中的表格、图和交叉参考的编号格式.....	1
• 在整个数据表中添加了 SOT23-8 (DDF) 封装信息.....	1
• 删除了 <i>器件信息</i> 表中 LM358B 和 LM2904B VSSOP (8) 封装的预发布标签.....	1
• 在 <i>热性能信息表</i> 中添加了 DDF (SOT-23) 封装.....	6

Changes from Revision W (October 2019) to Revision X (June 2020) Page

• 向 <i>应用</i> 部分添加了应用链接.....	1
• 删除了 <i>器件信息</i> 表中 LM358B 和 LM2904B TSSOP (8) 封装的预发布标签.....	1

Changes from Revision V (September 2018) to Revision W (October 2019)	Page
• 更改了 ESD 等级中 LM358B 和 LM2904B 的 CDM ESD 等级.....	5
• 将 建议运行条件中的 V_S 更改为 V_+	6
• 更改了 LM158FK 和 LM158JG 器件的热性能信息.....	6
• 为 LM358B 和 LM2490B 运算放大器添加了典型特性部分.....	18
• 在 参数测量信息部分中添加了 THD+N 和小信号阶跃响应的测试电路 ($G = -1$).....	27
• 更改了 功能方框图.....	28

Changes from Revision U (January 2017) to Revision V (September 2018)	Page
• 更改了数据表标题.....	1
• 更改了 特性 部分中的前四项.....	1
• 更改了 应用 部分中的第一项并添加了四个新项.....	1
• 更改了 说明 部分第一段中的电压值.....	1
• 更改了 说明 部分第二段中的文本内容.....	1
• 在数据表中添加了器件 LM358B 和 LM2904B.....	1
• 更改了 器件信息 表的前三行，并为状态为预发布的器件添加了交叉参考注释.....	1
• 向 引脚功能表 中添加了表格注释.....	4
• 将 绝对最大额定值 说明中的“自然通风条件下的温度”更改为“环境温度”.....	5
• 更改了 绝对最大额定值 表中除 T_J 和 T_{stg} 以外的所有条目.....	5
• 从 绝对最大额定值 中删除了引线温度和外壳温度.....	5
• 更改了 ESD 等级 表中的器件列表及其电压值.....	5
• 将 建议运行条件 说明中的“自然通风条件下的温度”更改为“环境温度”.....	6
• 更改了 建议运行条件 表中所有参数的表格条目.....	6
• 向“热性能信息”表中添加了几行，以及有关器件封装组合的表格注释.....	6
• 删除了 运行条件表.....	17
• 向 典型特性 部分添加了条件说明.....	25
• 将具体电压更改为对 建议运行条件 的引用.....	28
• 将单位增益带宽从所有器件为 0.7MHz 更改为 B 版本器件为 1.2MHz.....	29
• 将压摆率从所有器件均为 0.3V/ μ s 更改为 B 版本器件为 0.5V/ μ s.....	29
• 通篇更改了多处的 节 8.3.3 部分.....	29
• 在 节 9.1 部分中，将 V_{CC} 更改为 V_S	30
• 将 R_I 和 R_F 的后缀处理成了下标.....	30
• 更改了 非反相配置的运算放大器电路板布局 并添加了包含双通道运算放大器的图像.....	32

Changes from Revision T (April 2015) to Revision U (January 2017)	Page
• 更改了数据表标题.....	1

Changes from Revision S (January 2014) to Revision T (April 2015)	Page
• 添加了 应用 部分、ESD 等级表、特性说明部分、器件功能模式、应用和实施部分、电源相关建议部分、布局部分、器件和文档支持部分以及机械、封装和可订购信息部分.....	1

Changes from Revision R (July 2010) to Revision S (January 2014)	Page
• 使用网上的 PDF 将此数据表从 QS 格式转换为 DocZone.....	1
• 删除了 订购信息 表.....	1
• 更新了 特性 部分以包含“军用免责声明”.....	1
• 添加了“典型特性”部分.....	25

5 引脚配置和功能



图 5-1. D、DDF、DGK、P、PS、PW 和 JG 封装
 8 引脚 SOIC、SOT23-8、VSSOP、PDIP、SO、
 TSSOP 和 CDIP
 顶视图



NC - 无内部连接

图 5-2. FK 封装
 20 引脚 LCCC
 顶视图

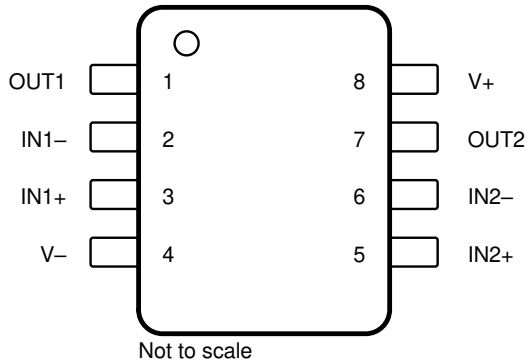
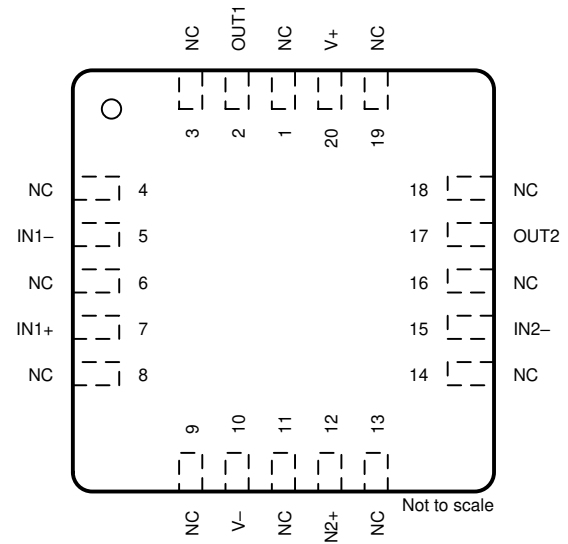
表 5-1. 引脚功能

名称	引脚		I/O	说明
	LCCC ⁽¹⁾	SOIC、SOT23-8、VSSOP、 CDIP、PDIP、SO、TSSOP、 CFP ⁽¹⁾		
IN1 -	5	2	I	负输入
IN1+	7	3	I	正输入
IN2 -	15	6	I	负输入
IN2+	12	5	I	正输入
OUT1	2	1	O	输出
OUT2	17	7	O	输出
V -	10	4	—	负 (最低) 电源或接地 (对于单电源供电)
NC	1、3、4、6、8、 9、11、13、14、 16、18、19	—	—	没有与内部电路连接
V+	20	8	—	正 (最高) 电源

(1) 有关器件列表及器件采用的具体封装，请参阅节 3。

6 规格

6.1 绝对最大额定值

在工作环境温度范围内 (除非另外注明) ⁽¹⁾

		最小值	最大值	单位	
电源电压, $V_S = ([V+] - [V-])$	LM358B、LM358BA、 LM2904B、LM2904BA		±20 或 40	V	
	LM158、LM258、LM358、 LM158A、LM258A、 LM358A、LM2904V		±16 或 32		
	LM2904		±13 或 26		
差分输入电压, V_{ID} ⁽²⁾	LM358B、LM358BA、 LM2904B、LM2904BA、 LM158、LM258、LM358、 LM158A、LM258A、 LM358A、LM2904V	-32	32	V	
	LM2904	-26	26		
输入电压, V_I	任一输入	LM358B、LM358BA、 LM2904B、LM2904BA	-0.3	40	V
		LM158、LM258、LM358、 LM158A、LM258A、 LM358A、LM2904V	-0.3	32	
		LM2904	-0.3	26	
输出对地短路 (一个放大器) 的持续时间 (在或低于 $T_A = 25^\circ\text{C}$ 、 $V_S \leq 15\text{V}$ 条件下) ⁽³⁾			无限	s	
工作环境温度, T_A	LM158、LM158A	-55	125	°C	
	LM258、LM258A	-25	85		
	LM358B、LM358BA	-40	85		
	LM358、LM358A	0	70		
	LM2904B、LM2904BA、 LM2904、LM2904V	-40	125		
运行虚拟结温, T_J			150	°C	
贮存温度, T_{stg}		-65	150	°C	

(1) 超出绝对最大额定值下列出的值的应力可能会对器件造成永久损坏。这些仅为应力额定值, 并不表示器件在这些条件下以及在建议运行条件以外的任何其他条件下能够正常运行。长时间处于最大绝对额定情况下会影响设备的可靠性。

(2) 差分电压是相对于 $IN-$ 的 $IN+$ 上的值。

(3) 从输出到 V_S 的短路会导致过热, 并且最终会发生损坏。

6.2 ESD 等级

		值	单位
LM358B、LM358BA、LM2904B 和 LM2904BA			
$V_{(ESD)}$ 静电放电	人体放电模型 (HBM), 符合 ANSI/ESDA/JEDEC JS-001 标准 ⁽¹⁾	±2000	V
	充电器件模型 (CDM), 符合 JEDEC 规范 JESD22-C101 ⁽²⁾	±1500	
LM158、LM258、LM358、LM158A、LM258A、LM358A、LM2904 和 LM2904V			
$V_{(ESD)}$ 静电放电	人体放电模型 (HBM), 符合 ANSI/ESDA/JEDEC JS-001 标准 ⁽¹⁾	±500	V
	充电器件模型 (CDM), 符合 JEDEC 规范 JESD22-C101 ⁽²⁾	±1000	

(1) JEDEC 文档 JEP155 指出: 500V HBM 时能够在标准 ESD 控制流程下安全生产。

(2) JEDEC 文件 JEP157 指出: 250V CDM 可实现在标准 ESD 控制流程下安全生产。

6.3 建议运行条件

在工作环境温度范围内测得 (除非另外注明)

		最小值	最大值	单位	
V _S	电源电压, V _S = ([V+] - [V-])	LM358B、LM358BA、LM2904B、 LM2904BA	3	36	V
		LM158、LM258、LM358、LM158A、 LM258A、LM358A、LM2904V	3	30	
		LM2904	3	26	
V _{CM}	共模电压	V -	V+ - 2	V	
T _A	工作环境温度	LM358B、LM358BA	- 40	85	°C
		LM2904B、LM2904BA、LM2904、 LM2904V	-40	125	
		LM358、LM358A	0	70	
		LM258、LM258A	-20	85	
		LM158、LM158A	- 55	125	

6.4 热性能信息

热指标 ⁽¹⁾	LM258、LM258A、LM358、LM358A、LM358B、LM358BA、LM2904、 LM2904B、LM2904BA、LM2904V ⁽²⁾						LM158、LM158A		单位	
	D (SOIC)	DGK (VSSOP)	P (PDIP)	PS (SO)	PW (TSSOP)	DDF (SOT-23)	FK (LCCC)	JG (CDIP)		
	8 个引脚	8 个引脚	8 个引脚	8 个引脚	8 个引脚	8 个引脚	20 个引脚	8 个引脚		
R _{θJA}	结至环境热阻	124.7	181.4	80.9	116.9	171.7	164.3	84.0	112.4	°C/W
R _{θJC(top)}	结至外壳 (顶部) 热阻	66.9	69.4	70.4	62.5	68.8	98.1	56.9	63.6	°C/W
R _{θJB}	结至电路板热阻	67.9	102.9	57.4	68.6	99.2	82.1	57.5	100.3	°C/W
ψ _{JT}	结至顶部特征参数	19.2	11.8	40	21.9	11.5	11.4	51.7	35.7	°C/W
ψ _{JB}	结至电路板特征参数	67.2	101.2	56.9	67.6	97.9	81.7	57.1	93.3	°C/W
R _{θJC(bot)}	结至外壳 (底部) 热阻	—	—	—	—	—	—	10.6	22.3	°C/W

- (1) 有关新旧热指标的更多信息, 请参阅 [半导体和 IC 封装热指标](#)。
 (2) 有关器件列表及器件采用的具体封装, 请参阅 [节 3](#)。

6.5 电气特性：LM358B 和 LM358BA

在 $V_S = (V+) - (V-) = 5V$ 至 $36V$ ($\pm 2.5V$ 至 $\pm 18V$)、 $T_A = 25^\circ C$ 、 $V_{CM} = V_{OUT} = V_S / 2$ 、 $R_L = 10k\Omega$ (连接至 $V_S / 2$) 条件下 (除非另有说明)

参数		测试条件		最小值	典型值	最大值	单位	
失调电压								
V_{OS}	输入失调电压	LM358B			± 0.3	± 3.0	mV	
			$T_A = -40^\circ C$ 至 $+85^\circ C$			± 4		mV
		LM358BA				± 2.0		mV
			$T_A = -40^\circ C$ 至 $+85^\circ C$			± 2.5		mV
dV_{OS}/dT	输入失调电压漂移		$T_A = -40^\circ C$ 至 $+85^\circ C^{(1)}$	± 3.5	11		$\mu V/^\circ C$	
PSRR	电源抑制比			± 2	15		$\mu V/V$	
	通道分离, 直流	$f = 1\text{ kHz}$ 至 20 kHz		± 1			$\mu V/V$	
输入电压范围								
V_{CM}	共模电压范围	$V_S = 3V$ 至 $36V$			$(V-)$	$(V+) - 1.5$	V	
		$V_S = 5V$ 至 $36V$		$T_A = -40^\circ C$ 至 $+85^\circ C$	$(V-)$	$(V+) - 2$	V	
CMRR	共模抑制比	$(V-) \leq V_{CM} \leq (V+) - 1.5V$	$V_S = 3V$ 至 $36V$		20	100	$\mu V/V$	
		$(V-) \leq V_{CM} \leq (V+) - 2.0V$	$V_S = 5V$ 至 $36V$	$T_A = -40^\circ C$ 至 $+85^\circ C$	25	316		
输入偏置电流								
I_B	输入偏置电流				± 10	± 35	nA	
				$T_A = -40^\circ C$ 至 $+85^\circ C^{(1)}$		± 50	nA	
I_{OS}	输入失调电流				0.5	4	nA	
				$T_A = -40^\circ C$ 至 $+85^\circ C^{(1)}$		5	nA	
dI_{OS}/dT	输入失调电流漂移		$T_A = -40^\circ C$ 至 $+85^\circ C$	10			$pA/^\circ C$	
噪声								
E_n	输入电压噪声	$f = 0.1\text{ Hz}$ 至 10 Hz			3		μV_{PP}	
e_n	输入电压噪声密度	$f = 1\text{ kHz}$			40		nV/\sqrt{Hz}	
输入阻抗								
Z_{ID}	差分				$10 \parallel 0.1$		$M\Omega \parallel pF$	
Z_{IC}	共模				$4 \parallel 1.5$		$G\Omega \parallel pF$	
开环增益								
A_{OL}	开环电压增益	$V_S = 15V$; $V_O = 1V$ 至 $11V$; $R_L \geq 10k\Omega$ (连接到 $(V-)$)			70	140	V/mV	
				$T_A = -40^\circ C$ 至 $+85^\circ C$	35		V/mV	
频率响应								
GBW	增益带宽积				1.2		MHz	
SR	压摆率	$G = +1$			0.5		V/ μs	
θ_m	相位裕度	$G = +1$, $R_L = 10k\Omega$, $C_L = 20pF$			56		$^\circ$	
t_{OR}	过载恢复时间	$V_{IN} \times \text{增益} > V_S$			10		μs	
t_s	建立时间	精度达到 0.1%, $V_S = 5V$, 2V 阶跃, $G = +1$, $C_L = 100pF$			4		μs	
THD+N	总谐波失真 + 噪声	$G = +1$, $f = 1\text{ kHz}$, $V_O = 3.53V_{RMS}$, $V_S = 36V$, $R_L = 100k\Omega$, $I_{OUT} \leq \pm 50\mu A$, $BW = 80\text{ kHz}$			0.001		%	
输出								
V_O	相对于电源轨的电压输出摆幅	正电源轨 ($V+$)	$I_{OUT} = 50\mu A$		1.35	1.42	V	
			输出电流 = 1 mA		1.4	1.48	V	
			$I_{OUT} = 5mA^{(1)}$		1.5	1.61	V	
		负电源轨 ($V-$)	$I_{OUT} = 50\mu A$		100	150	mV	
			输出电流 = 1 mA		0.75	1	V	
			$V_S = 5V$, $R_L \leq 10k\Omega$ (连接到 $(V-)$)	$T_A = -40^\circ C$ 至 $+85^\circ C$	5	20	mV	
I_O	输出电流	$V_S = 15V$; $V_O = V-$; $V_{ID} = 1V$	吸电流 ⁽¹⁾		-20	-30	mA	
			$T_A = -40^\circ C$ 至 $+85^\circ C$		-10			
		$V_S = 15V$; $V_O = V+$; $V_{ID} = -1V$	灌电流 ⁽¹⁾		10	20		
			$T_A = -40^\circ C$ 至 $+85^\circ C$		5			
		$V_{ID} = -1V$; $V_O = (V-) + 200mV$		60	100	μA		
I_{SC}	短路电流	$V_S = 20V$, $(V+) = 10V$, $(V-) = -10V$, $V_O = 0V$			± 40	± 60	mA	

6.5 电气特性：LM358B 和 LM358BA (continued)

在 $V_S = (V+) - (V-) = 5V$ 至 $36V$ ($\pm 2.5V$ 至 $\pm 18V$)、 $T_A = 25^\circ C$ 、 $V_{CM} = V_{OUT} = V_S / 2$ 、 $R_L = 10k\Omega$ (连接至 $V_S / 2$) 条件下 (除非另有说明)

参数		测试条件	最小值	典型值	最大值	单位
C_{LOAD}	容性负载驱动			100		pF
R_O	开环输出电阻	$f=1MHz, I_O=0A$		300		Ω

6.5 电气特性：LM358B 和 LM358BA (continued)

在 $V_S = (V+) - (V-) = 5V$ 至 $36V$ ($\pm 2.5V$ 至 $\pm 18V$)、 $T_A = 25^\circ C$ 、 $V_{CM} = V_{OUT} = V_S / 2$ 、 $R_L = 10k\Omega$ (连接至 $V_S / 2$) 条件下 (除非另有说明)

参数		测试条件		最小值	典型值	最大值	单位
电源							
I_Q	每个放大器的静态电流	$V_S = 5V, I_O = 0A$	$T_A = -40^\circ C$ 至 $+85^\circ C$		300	460	μA
I_Q	每个放大器的静态电流	$V_S = 36V, I_O = 0A$				800	μA

(1) 仅由特征确定。

6.6 电气特性：LM2904B 和 LM2904BA

在 $V_S = (V+) - (V-) = 5V$ 至 $36V$ ($\pm 2.5V$ 至 $\pm 18V$)、 $T_A = 25^\circ C$ 、 $V_{CM} = V_{OUT} = V_S / 2$ 、 $R_L = 10k\Omega$ (连接至 $V_S / 2$) 条件下 (除非另有说明)

参数		测试条件		最小值	典型值	最大值	单位	
失调电压								
V_{OS}	输入失调电压	LM2904B		± 0.3	± 3.0		mV	
			$T_A = -40^\circ C$ 至 $+125^\circ C$			± 4		mV
		LM2904BA				± 2.0		mV
			$T_A = -40^\circ C$ 至 $+125^\circ C$			± 3.0		mV
dV_{OS}/dT	输入失调电压漂移		$T_A = -40^\circ C$ 至 $+125^\circ C^{(1)}$	± 3.5	12		$\mu V/^\circ C$	
PSRR	电源抑制比			± 2	15		$\mu V/V$	
	通道分离, 直流	$f = 1\text{ kHz}$ 至 20 kHz		± 1			$\mu V/V$	
输入电压范围								
V_{CM}	共模电压范围	$V_S = 3V$ 至 $36V$		(V-)	(V+) - 1.5		V	
		$V_S = 5V$ 至 $36V$	$T_A = -40^\circ C$ 至 $+125^\circ C$	(V-)	(V+) - 2		V	
CMRR	共模抑制比	$(V-) \leq V_{CM} \leq (V+) - 1.5V$	$V_S = 3V$ 至 $36V$		20	100	$\mu V/V$	
		$(V-) \leq V_{CM} \leq (V+) - 2.0V$	$V_S = 5V$ 至 $36V$	$T_A = -40^\circ C$ 至 $+125^\circ C$		25		316
输入偏置电流								
I_B	输入偏置电流				± 10	± 35	nA	
			$T_A = -40^\circ C$ 至 $+125^\circ C^{(1)}$			± 50	nA	
I_{OS}	输入失调电流				0.5	4	nA	
			$T_A = -40^\circ C$ 至 $+125^\circ C^{(1)}$			5	nA	
dI_{OS}/dT	输入失调电流漂移		$T_A = -40^\circ C$ 至 $+125^\circ C$		10		$pA/^\circ C$	
噪声								
E_n	输入电压噪声	$f = 0.1\text{ Hz}$ 至 10 Hz			3		μV_{PP}	
e_n	输入电压噪声密度	$f = 1\text{ kHz}$			40		nV/\sqrt{Hz}	
输入阻抗								
Z_{ID}	差分				$10 \parallel 0.1$		$M\Omega \parallel pF$	
Z_{IC}	共模				$4 \parallel 1.5$		$G\Omega \parallel pF$	
开环增益								
A_{OL}	开环电压增益	$V_S = 15V$; $V_O = 1V$ 至 $11V$; $R_L \geq 10k\Omega$ (连接到 (V-))			70	140	V/mV	
			$T_A = -40^\circ C$ 至 $+125^\circ C$		35		V/mV	
频率响应								
GBW	增益带宽积				1.2		MHz	
SR	压摆率	$G = +1$			0.5		V/ μs	
θ_m	相位裕度	$G = +1$, $R_L = 10k\Omega$, $C_L = 20pF$			56		$^\circ$	
t_{OR}	过载恢复时间	$V_{IN} \times \text{增益} > V_S$			10		μs	
t_s	建立时间	精度达到 0.1%, $V_S = 5V$, 2V 阶跃, $G = +1$, $C_L = 100pF$			4		μs	
THD+N	总谐波失真 + 噪声	$G = +1$, $f = 1\text{ kHz}$, $V_O = 3.53V_{RMS}$, $V_S = 36V$, $R_L = 100k\Omega$, $I_{OUT} \leq \pm 50\mu A$, $BW = 80\text{ kHz}$			0.001		%	
输出								
V_O	相对于电源轨的电压输出摆幅	正电源轨 (V+)	$I_{OUT} = 50\mu A$		1.35	1.42	V	
			输出电流 = 1 mA		1.4	1.48	V	
			$I_{OUT} = 5mA^{(1)}$		1.5	1.61	V	
		负电源轨 (V-)	$I_{OUT} = 50\mu A$		100	150	mV	
			输出电流 = 1 mA		0.75	1	V	
			$V_S = 5V$, $R_L \leq 10k\Omega$ 连接到 (V-)	$T_A = -40^\circ C$ 至 $+125^\circ C$		5	20	mV
I_O	输出电流	$V_S = 15V$; $V_O = V^-$; $V_{ID} = 1V$	吸电流 ⁽¹⁾		-20	-30	mA	
			$T_A = -40^\circ C$ 至 $+125^\circ C$		-10			
		$V_S = 15V$; $V_O = V^+$; $V_{ID} = 1V$	灌电流 ⁽¹⁾		10	20		
			$T_A = -40^\circ C$ 至 $+125^\circ C$		5			
I_{SC}	短路电流	$V_S = 20V$, (V+) = 10V, (V-) = -10V, $V_O = 0V$			± 40	± 60	mA	
C_{LOAD}	容性负载驱动				100		pF	

在 $V_S = (V+) - (V-) = 5V$ 至 $36V$ ($\pm 2.5V$ 至 $\pm 18V$)、 $T_A = 25^\circ C$ 、 $V_{CM} = V_{OUT} = V_S / 2$ 、 $R_L = 10k\Omega$ (连接至 $V_S / 2$) 条件下 (除非另有说明)

参数		测试条件	最小值	典型值	最大值	单位
R_o	开环输出电阻	$f=1MHz, I_o = 0A$		300		Ω
电源						
I_Q	每个放大器的静态电流	$V_S = 5V, I_o = 0A$		300	460	μA
I_Q	每个放大器的静态电流	$V_S = 36V, I_o = 0A$			800	μA

(1) 仅由特征确定。

6.7 电气特性：LM358、LM358A

在 $V_S = (V+) - (V-) = 5V$, $T_A = 25^\circ C$ 条件下测得 (除非另有说明)

参数	测试条件 ⁽¹⁾	最小值	典型值 ⁽²⁾	最大值	单位		
失调电压							
V_{OS} 输入失调电压	$V_S = 5V$ 至 $30V$; $V_{CM} = 0V$; $V_O = 1.4V$	LM358		3	7	mV	
			$T_A = 0^\circ C$ 至 $70^\circ C$		9		
		LM358A		2	3		
			$T_A = 0^\circ C$ 至 $70^\circ C$		5		
dV_{OS}/dT 输入失调电压漂移		LM358	$T_A = 0^\circ C$ 至 $70^\circ C$	7		$\mu V/^\circ C$	
		LM358A	$T_A = 0^\circ C$ 至 $70^\circ C$	7	20		
PSRR 输入失调电压与电源电压间的关系 ($\Delta V_{IO}/\Delta V_S$)	$V_S = 5V$ 至 $30V$			65	100	dB	
V_{O1}/V_{O2} 通道分离	$f = 1 kHz$ 至 $20kHz$				120	dB	
输入电压范围							
V_{CM} 共模电压范围	$V_S = 5V$ 至 $30V$	LM358		(V-)	(V+) - 1.5	V	
	$V_S = 30V$	LM358A					
	$V_S = 5V$ 至 $30V$	LM358	$T_A = 0^\circ C$ 至 $70^\circ C$	(V-)	(V+) - 2		
	$V_S = 30V$	LM358A					
CMRR 共模抑制比	$V_S = 5V$ 至 $30V$; $V_{CM} = 0V$			65	80	dB	
输入偏置电流							
I_B 输入偏置电流	$V_O = 1.4V$	LM358		-20	-250	nA	
			$T_A = 0^\circ C$ 至 $70^\circ C$		-500		
		LM358A		-15	-100		
			$T_A = 0^\circ C$ 至 $70^\circ C$		-200		
I_{OS} 输入失调电流	$V_O = 1.4V$	LM358		2	50	nA	
			$T_A = 0^\circ C$ 至 $70^\circ C$		150		
		LM358A		2	30		
			$T_A = 0^\circ C$ 至 $70^\circ C$		75		
dI_{OS}/dT 输入失调电流漂移				10		$pA/^\circ C$	
		LM358A	$T_A = 0^\circ C$ 至 $70^\circ C$		300		
噪声							
e_n 输入电压噪声密度	$f = 1kHz$			40		nV/\sqrt{Hz}	
开环增益							
A_{OL} 开环电压增益	$V_S = 15V$; $V_O = 1V$ 至 $11V$; $R_L \geq 2k\Omega$			25	100	V/mV	
			$T_A = 0^\circ C$ 至 $70^\circ C$	15			
频率响应							
GBW 增益带宽积				0.7		MHz	
SR 压摆率	$G = +1$			0.3		V/ μs	
输出							
V_O 自电源轨的电压输出摆幅	正电源轨	$V_S = 30V$; $R_L = 2k\Omega$	$T_A = 0^\circ C$ 至 $70^\circ C$		4	V	
		$V_S = 30V$; $R_L \geq 10k\Omega$		2	3		
		$V_S = 5V$; $R_L \geq 2k\Omega$				1.5	
	负电源轨	$V_S = 5V$; $R_L \leq 10k\Omega$	$T_A = 0^\circ C$ 至 $70^\circ C$	5	20	mV	
I_O 输出电流	$V_S = 15V$; $V_O = 0V$; $V_{ID} = 1V$	吸电流	LM358		-20	-30	mA
				$T_A = 0^\circ C$ 至 $70^\circ C$		-60	
	$V_S = 15V$; $V_O = 15V$; $V_{ID} = -1V$	灌电流		$T_A = 0^\circ C$ 至 $70^\circ C$	10	20	
				$T_A = 0^\circ C$ 至 $70^\circ C$	5		
	$V_{ID} = -1V$; $V_O = 200mV$			12	30	μA	
I_{SC} 短路电流	$V_S = 10V$; $V_O = V_S/2$			± 40	± 60	mA	
电源							
I_Q 每个放大器的静态电流	$V_O = 2.5V$; $I_O = 0A$		$T_A = 0^\circ C$ 至 $70^\circ C$	350	600	μA	
	$V_S = 30V$; $V_O = 15V$; $I_O = 0A$			500	1000		

(1) 除非另有说明, 所有特性均在开环条件下以零共模输入电压测定。对于 LM358 和 LM358A, 用于测试目的的最大 V_S 为 30V。

(2) 所有典型值均在 $T_A=25^{\circ}\text{C}$ 下测得。

6.8 电气特性：LM2904、LM2904V

在 $V_S = (V+) - (V-) = 5V$, $T_A = 25^\circ C$ 条件下测得 (除非另有说明)

参数	测试条件 ⁽¹⁾		最小值	典型值 ⁽²⁾	最大值	单位	
失调电压							
V_{OS} 输入失调电压	$V_S = 5V$ 至最大值; $V_{CM} = 0V$; $V_O = 1.4V$	不带后级 A 的器件	$T_A = -40^\circ C$ 至 $125^\circ C$	3	7	mV	
			$T_A = -40^\circ C$ 至 $125^\circ C$		10		
		A 后级器件	$T_A = -40^\circ C$ 至 $125^\circ C$	1	2		
			$T_A = -40^\circ C$ 至 $125^\circ C$		4		
dV_{OS}/dT 输入失调电压漂移		$T_A = -40^\circ C$ 至 $125^\circ C$	7		$\mu V/^\circ C$		
PSRR 输入失调电压与电源电压间的关系 ($\Delta V_{IO}/\Delta V_S$)	$V_S = 5V$ 至 $30V$		65	100		dB	
V_{O1}/V_{O2} 通道分离	$f = 1kHz$ 至 $20kHz$			120		dB	
输入电压范围							
V_{CM} 共模电压范围	$V_S = 5V$ 至最大值		(V-)	(V+) - 1.5		V	
		$T_A = -40^\circ C$ 至 $125^\circ C$	(V-)	(V+) - 2			
CMRR 共模抑制比	$V_S = 5V$ 至最大值; $V_{CM} = 0V$		65	80		dB	
输入偏置电流							
I_B 输入偏置电流	$V_O = 1.4V$			-20	-250	nA	
		$T_A = -40^\circ C$ 至 $125^\circ C$			-500		
I_{OS} 输入失调电流	$V_O = 1.4V$	不带后级 V 的器件	$T_A = -40^\circ C$ 至 $125^\circ C$	2	50	nA	
			$T_A = -40^\circ C$ 至 $125^\circ C$		300		
		带有 V 后级的器件	$T_A = -40^\circ C$ 至 $125^\circ C$	2	50		
			$T_A = -40^\circ C$ 至 $125^\circ C$		150		
dI_{OS}/dT 输入失调电流漂移		$T_A = -40^\circ C$ 至 $125^\circ C$	10		$pA/^\circ C$		
噪声							
e_n 输入电压噪声密度	$f = 1kHz$			40		nV/\sqrt{Hz}	
开环增益							
A_{OL} 开环电压增益	$V_S = 15V$; $V_O = 1V$ 至 $11V$; $R_L \geq 2k\Omega$		25	100		V/mV	
		$T_A = -40^\circ C$ 至 $125^\circ C$	15				
频率响应							
GBW 增益带宽积				0.7		MHz	
SR 压摆率	$G = +1$			0.3		V/ μs	
输出							
V_O 自电源轨的电压输出摆幅	正电源轨	$R_L \geq 10k\Omega$	不带后级 V 的器件	$V_S =$ 最大值; $R_L = 2k\Omega$	$T_A = -40^\circ C$ 至 $125^\circ C$	4	V
				$V_S =$ 最大值; $R_L \geq 10k\Omega$		2	
		带有 V 后级的器件	$V_S =$ 最大值; $R_L = 2k\Omega$		6		
			$V_S =$ 最大值; $R_L \geq 10k\Omega$		4	5	
	负电源轨	$V_S = 5V$; $R_L \leq 10k\Omega$	$T_A = -40^\circ C$ 至 $125^\circ C$	5	20	mV	
	I_O 输出电流	$V_S = 15V$; $V_O = 0V$; $V_{ID} = 1V$	吸电流	$T_A = -40^\circ C$ 至 $125^\circ C$	-20	-30	
$T_A = -40^\circ C$ 至 $125^\circ C$				-10			
$V_S = 15V$; $V_O = 15V$; $V_{ID} = -1V$		灌电流	$T_A = -40^\circ C$ 至 $125^\circ C$	10	20		
			$T_A = -40^\circ C$ 至 $125^\circ C$	5			
$V_{ID} = -1V$; $V_O = 200mV$		不带后级 V 的器件		30		μA	
	带有 V 后级的器件		12	40			
I_{SC} 短路电流	$V_S = 10V$; $V_O = V_S/2$		± 40	± 60		mA	
电源							
I_Q 每个放大器的静态电流	$V_O = 2.5V$; $I_O = 0A$	$T_A = -40^\circ C$ 至 $125^\circ C$		350	600	μA	
	$V_S =$ 最大值; $V_O =$ 最大值 / 2; $I_O = 0A$			500	1000		

- (1) 除非另有说明, 所有特性均在开环条件下以零共模输入电压测定。对于 LM2904, 用于测试目的的最大 V_S 为 26V, 对于 LM2904V 则为 32V。
 (2) 所有典型值均在 $T_A = 25^\circ C$ 下测得。

6.9 电气特性：LM158、LM158A

在 $V_S = (V+) - (V-) = 5V$, $T_A = 25^\circ C$ 条件下测得 (除非另有说明)

参数		测试条件 ⁽¹⁾		最小值	典型值 ⁽²⁾	最大值	单位	
失调电压								
V_{OS}	输入失调电压	$V_S = 5V$ 至 $30V$; $V_{CM} = 0V$; $V_O = 1.4V$	LM158	$T_A = -55^\circ C$ 至 $125^\circ C$	3	5	mV	
					7			
			LM158A	$T_A = -55^\circ C$ 至 $125^\circ C$	2			
					4			
dV_{OS}/dT	输入失调电压漂移		LM158	$T_A = -55^\circ C$ 至 $125^\circ C$	7		$\mu V/^\circ C$	
			LM158A	$T_A = -55^\circ C$ 至 $125^\circ C$	7	15 ⁽³⁾		
PSRR	输入失调电压与电源电压间的关系 ($\Delta V_{IO}/\Delta V_S$)	$V_S = 5V$ 至 $30V$			65	100	dB	
V_{O1}/V_{O2}	通道分离	$f = 1 kHz$ 至 $20kHz$				120	dB	
输入电压范围								
V_{CM}	共模电压范围	$V_S = 5V$ 至 $30V$	LM158		(V-)	(V+) - 1.5	V	
		$V_S = 30V$	LM158A					
		$V_S = 5V$ 至 $30V$	LM158	$T_A = -55^\circ C$ 至 $125^\circ C$	(V-)	(V+) - 2		
		$V_S = 30V$	LM158A					
CMRR	共模抑制比	$V_S = 5V$ 至 $30V$; $V_{CM} = 0V$			70	80	dB	
输入偏置电流								
I_B	输入偏置电流	$V_O = 1.4V$	LM158	$T_A = -55^\circ C$ 至 $125^\circ C$	-20	-150	nA	
					-300			
LM158A	$T_A = -55^\circ C$ 至 $125^\circ C$	-15	-50					
		-100						
I_{OS}	输入失调电流	$V_O = 1.4V$	LM158	$T_A = -55^\circ C$ 至 $125^\circ C$	2	30	nA	
					100			
			LM158A	$T_A = -55^\circ C$ 至 $125^\circ C$	2	10		
					30			
dI_{OS}/dT	输入失调电流漂移				10		$pA/^\circ C$	
			LM158A	$T_A = -55^\circ C$ 至 $125^\circ C$		200		
噪声								
e_n	输入电压噪声密度	$f = 1kHz$			40		nV/\sqrt{Hz}	
开环增益								
A_{OL}	开环电压增益	$V_S = 15V$; $V_O = 1V$ 至 $11V$; $R_L \geq 2k\Omega$			50	100	V/mV	
				$T_A = -55^\circ C$ 至 $125^\circ C$	25			
频率响应								
GBW	增益带宽积				0.7		MHz	
SR	压摆率	$G = +1$			0.3		V/ μs	
输出								
V_O	自电源轨的电压输出摆幅	正电源轨		$V_S = 30V$; $R_L = 2k\Omega$; $T_A = -55^\circ C$ 至 $125^\circ C$	4		V	
					$V_S = 30V$; $R_L \geq 10k\Omega$	2		3
					$V_S = 5V$; $R_L \geq 2k\Omega$			1.5
		负电源轨	$V_S = 5V$; $R_L \leq 10k\Omega$; $T_A = -55^\circ C$ 至 $125^\circ C$	5	20	mV		
I_O	输出电流	$V_S = 15V$; $V_O = 0V$; $V_{ID} = 1V$	吸电流	LM158A	-20	-30	mA	
					-60			
		$V_S = 15V$; $V_O = 15V$; $V_{ID} = -1V$	灌电流	$T_A = -55^\circ C$ 至 $125^\circ C$	10	20		
					5			
$V_{ID} = -1V$; $V_O = 200mV$			12	30	μA			
I_{SC}	短路电流	$V_S = 10V$; $V_O = V_S/2$			± 40	± 60	mA	

6.9 电气特性：LM158、LM158A (continued)

在 $V_S = (V+) - (V-) = 5V$, $T_A = 25^\circ C$ 条件下测得 (除非另有说明)

参数	测试条件 ⁽¹⁾	最小值	典型值 ⁽²⁾	最大值	单位
电源					
I_Q 每个放大器的静态电流	$V_O = 2.5V$; $I_O = 0A$	$T_A = -55^\circ C$ 至 $125^\circ C$	350	600	μA
	$V_S = 30V$; $V_O = 15V$; $I_O = 0A$		500	1000	

- (1) 除非另有说明，所有特性均在开环条件下以零共模输入电压测定。对于 LM158 和 LM158A，用于测试目的的最大 V_S 为 30V。
- (2) 所有典型值均在 $T_A=25^\circ C$ 下测得。
- (3) 对于符合 MIL-PRF-38535 标准的产品，此参数未经量产测试。

6.10 电气特性：LM258、LM258A

在 $V_S = (V+) - (V-) = 5V$, $T_A = 25^\circ C$ 条件下 (除非另有说明)

参数		测试条件 ⁽¹⁾		最小值	典型值 ⁽²⁾	最大值	单位	
失调电压								
V_{OS}	输入失调电压	$V_S = 5V$ 至 $30V$; $V_{CM} = 0V$; $V_O = 1.4V$	LM258		3	5	mV	
				$T_A = -25^\circ C$ 至 $85^\circ C$		7		
			LM258A		2	3		
				$T_A = -25^\circ C$ 至 $85^\circ C$		4		
dV_{OS}/dT	输入失调电压漂移		LM258		7	$\mu V/^\circ C$		
			LM258A	$T_A = -25^\circ C$ 至 $85^\circ C$	7		15	
PSRR	输入失调电压与电源电压间的关系 ($\Delta V_{IO}/\Delta V_S$)	$V_S = 5V$ 至 $30V$		65	100		dB	
V_{O1}/V_{O2}	通道分离	$f = 1\text{ kHz}$ 至 20 kHz			120		dB	
输入电压范围								
V_{CM}	共模电压范围	$V_S = 5V$ 至 $30V$	LM258		(V-)	(V+) - 1.5	V	
		$V_S = 30V$	LM258A					
		$V_S = 5V$ 至 $30V$	LM258	$T_A = -25^\circ C$ 至 $85^\circ C$	(V-)	(V+) - 2		
		$V_S = 30V$	LM258A					
CMRR	共模抑制比	$V_S = 5V$ 至 $30V$; $V_{CM} = 0V$		70	80		dB	
输入偏置电流								
I_B	输入偏置电流	$V_O = 1.4V$	LM258		-20	-150	nA	
				$T_A = -25^\circ C$ 至 $85^\circ C$		-300		
LM258A		-15	-80					
	$T_A = -25^\circ C$ 至 $85^\circ C$		-100					
I_{OS}	输入失调电流	$V_O = 1.4V$	LM258		2	30	nA	
				$T_A = -25^\circ C$ 至 $85^\circ C$		100		
			LM258A		2	15		
				$T_A = -25^\circ C$ 至 $85^\circ C$		30		
dI_{OS}/dT	输入失调电流漂移				10		$\text{pA}/^\circ C$	
			LM258A	$T_A = -25^\circ C$ 至 $85^\circ C$		200		
噪声								
e_n	输入电压噪声密度	$f = 1\text{ kHz}$			40		$\text{nV}/\sqrt{\text{Hz}}$	
开环增益								
A_{OL}	开环电压增益	$V_S = 15V$; $V_O = 1V$ 至 $11V$; $R_L \geq 2\text{ k}\Omega$			50	100	V/mV	
				$T_A = -25^\circ C$ 至 $85^\circ C$	25			
频率响应								
GBW	增益带宽积				0.7		MHz	
SR	压摆率	$G = +1$			0.3		V/ μs	
输出								
V_O	自电源轨的电压输出摆幅	正电源轨		$V_S = 30V$; $R_L = 2\text{ k}\Omega$	$T_A = -25^\circ C$ 至 $85^\circ C$	4	V	
				$V_S = 30V$; $R_L \geq 10\text{ k}\Omega$		2		3
				$V_S = 5V$; $R_L \geq 2\text{ k}\Omega$		1.5		
		负电源轨	$V_S = 5V$; $R_L \leq 10\text{ k}\Omega$	$T_A = -25^\circ C$ 至 $85^\circ C$	5	20		mV
I_O	输出电流	$V_S = 15V$; $V_O = 0V$; $V_{ID} = 1V$	吸电流			-20	-30	mA
				LM258A			-60	
		$V_S = 15V$; $V_O = 15V$; $V_{ID} = -1V$	灌电流		$T_A = -25^\circ C$ 至 $85^\circ C$	-10		
					$T_A = -25^\circ C$ 至 $85^\circ C$	5	20	
$V_{ID} = -1V$; $V_O = 200\text{ mV}$				12	30	μA		
I_{SC}	短路电流	$V_S = 10V$; $V_O = V_S/2$			± 40	± 60	mA	
电源								
I_Q	每个放大器的静态电流	$V_O = 2.5V$; $I_O = 0A$			350	600	μA	
		$V_S = 30V$; $V_O = 15V$; $I_O = 0A$		$T_A = -25^\circ C$ 至 $85^\circ C$	500	1000		

(1) 除非另有说明,所有特性均在开环条件下以零共模输入电压测定。对于 LM258 和 LM258A,用于测试目的的最大 V_S 为 30V。

(2) 所有典型值均在 $T_A=25^\circ\text{C}$ 下测得。

6.11 典型特性：LM358B 和 LM2904B

这个典型特性部分适用于 LM358B 和 LM2904B。此部分中的典型特性数据均在 $T_A = 25^\circ\text{C}$ 、 $V_S = 36\text{V} (\pm 18\text{V})$ 、 $V_{\text{CM}} = V_S / 2$ 、 $R_{\text{LOAD}} = 10\text{k}\Omega$ (连接到 $V_S / 2$) 条件下获得 (除非另有说明)。



图 6-1. 失调电压生产分配



图 6-2. 失调电压漂移分配

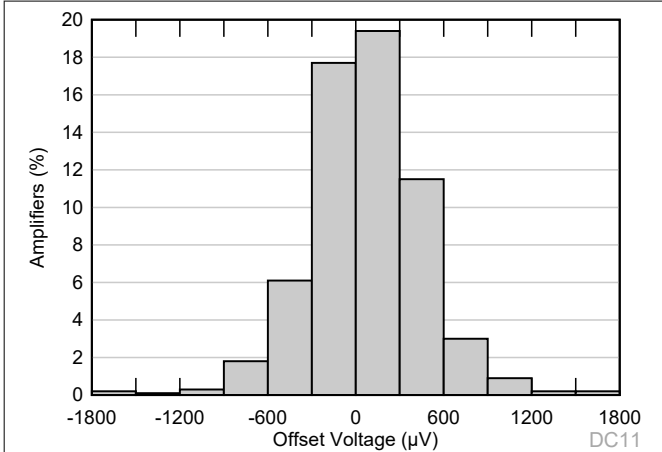

图 6-3. 失调电压与温度间的关系

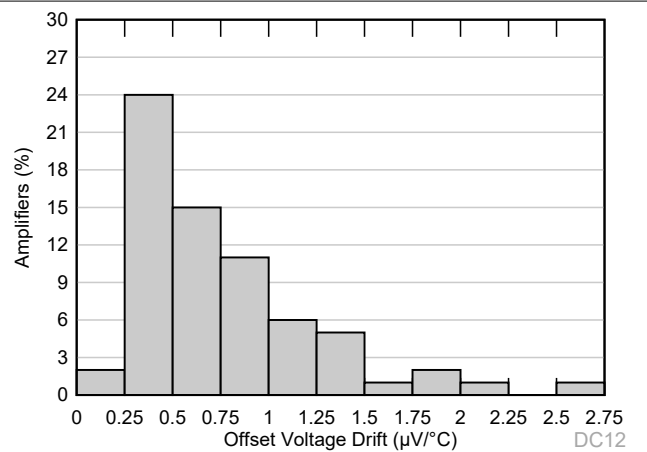

图 6-4. 失调电压与共模电压间的关系

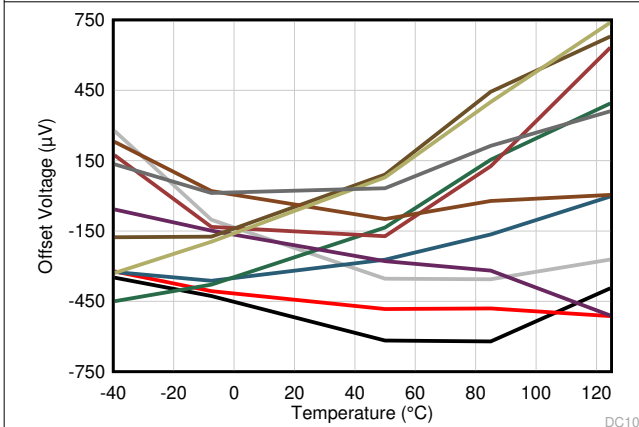

图 6-5. 开环增益和相位与频率间的关系

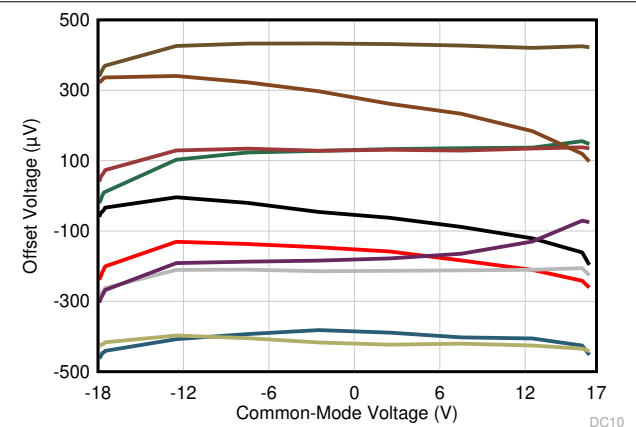

图 6-6. 闭环增益与频率间的关系

6.11 典型特性：LM358B 和 LM2904B (continued)

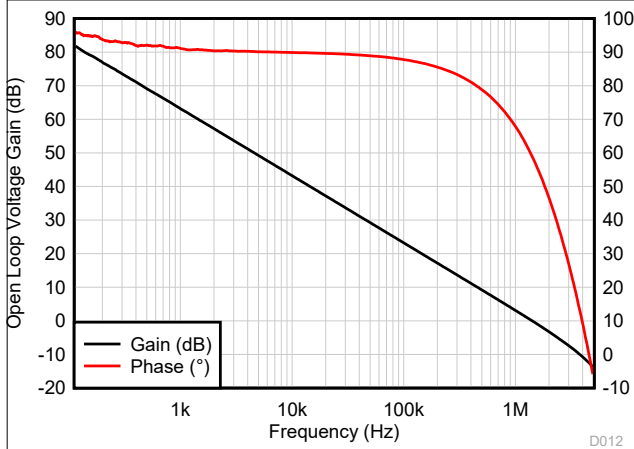
这个典型特性部分适用于 LM358B 和 LM2904B。此部分中的典型特性数据均在 $T_A = 25^\circ\text{C}$ 、 $V_S = 36\text{V} (\pm 18\text{V})$ 、 $V_{\text{CM}} = V_S / 2$ 、 $R_{\text{LOAD}} = 10\text{k}\Omega$ (连接到 $V_S / 2$) 条件下获得 (除非另有说明)。

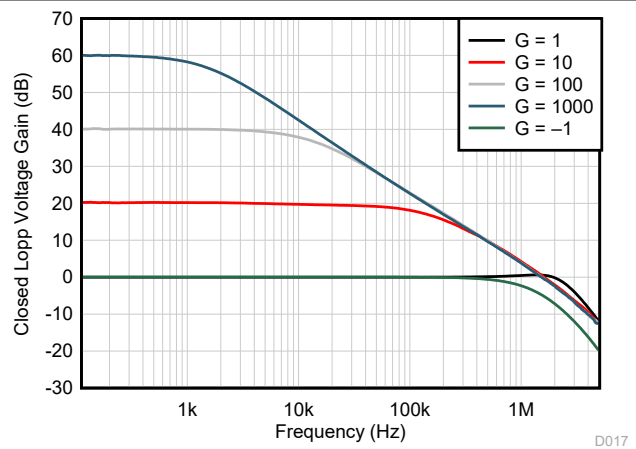

图 6-7. 输入偏置电流与共模电压间的关系



图 6-8. 输入失调电流与共模电压间的关系

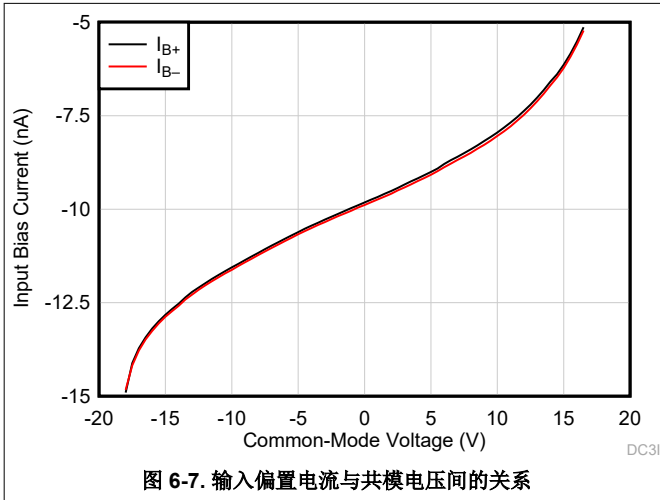

图 6-9. 输入偏置电流与温度间的关系

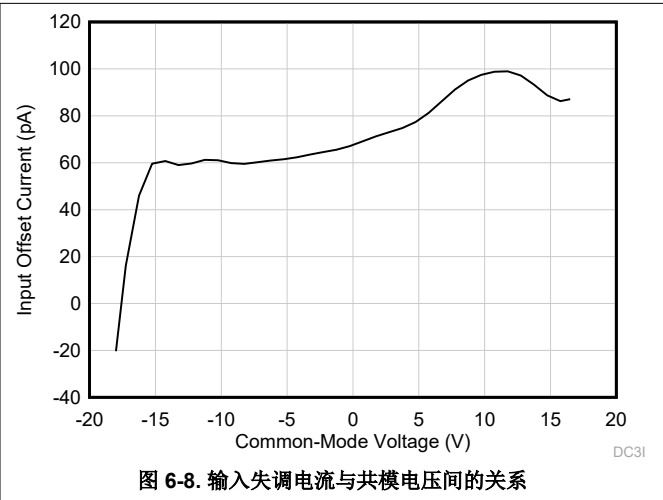

图 6-10. 输入失调电流与温度间的关系

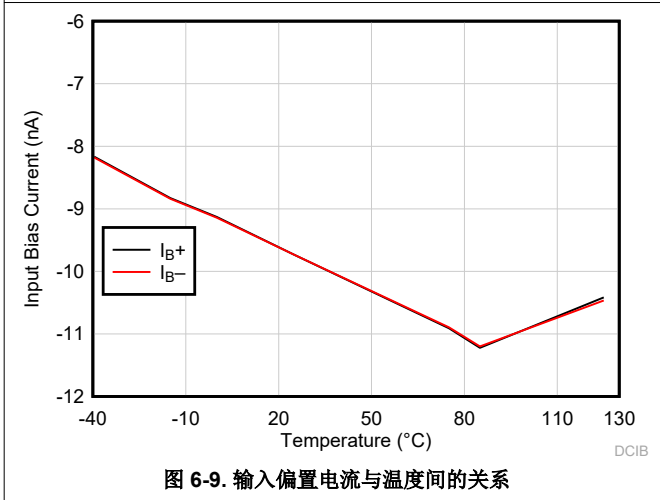

图 6-11. 输出电压摆幅与输出电流 (拉电流) 间的关系

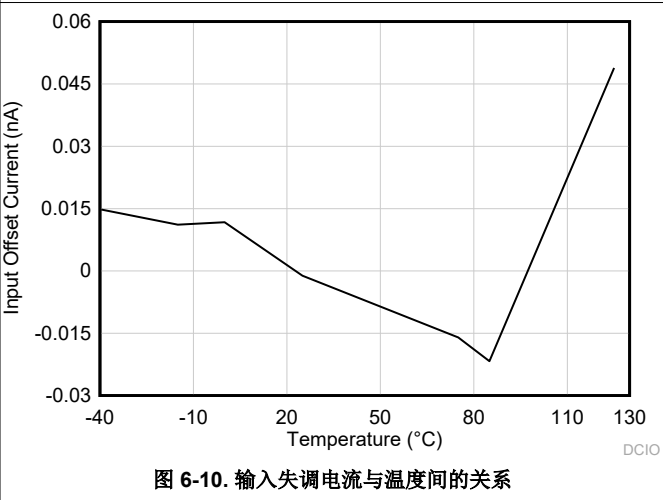

图 6-12. 输出电压摆幅与输出电流 (灌电流) 间的关系

6.11 典型特性：LM358B 和 LM2904B (continued)

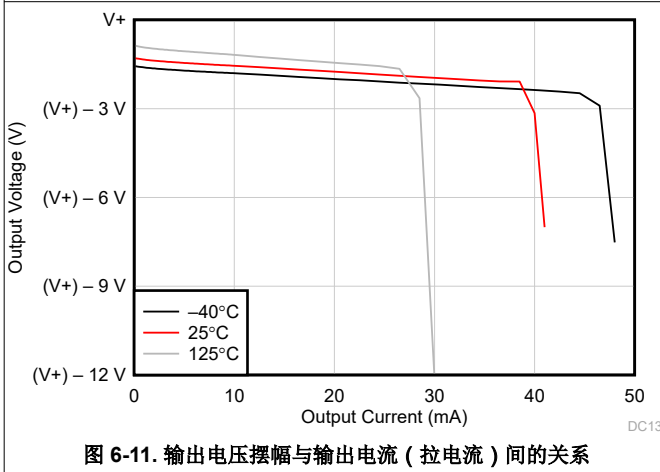
这个典型特性部分适用于 LM358B 和 LM2904B。此部分中的典型特性数据均在 $T_A = 25^\circ\text{C}$ 、 $V_S = 36\text{V} (\pm 18\text{V})$ 、 $V_{CM} = V_S / 2$ 、 $R_{LOAD} = 10\text{k}\Omega$ (连接到 $V_S / 2$) 条件下获得 (除非另有说明)。

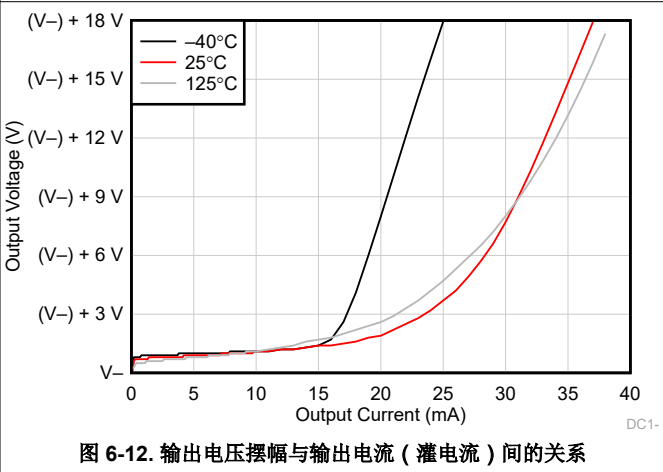

图 6-13. CMRR 和 PSRR 与频率间的关系



图 6-14. 共模抑制比与温度间的关系 (dB)

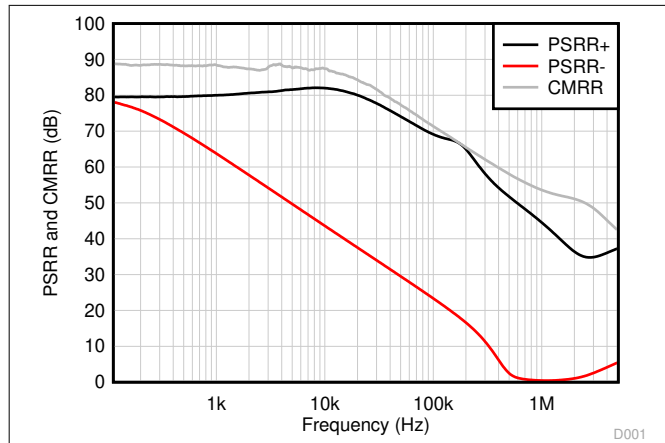

图 6-15. 电源抑制比与温度间的关系 (dB)

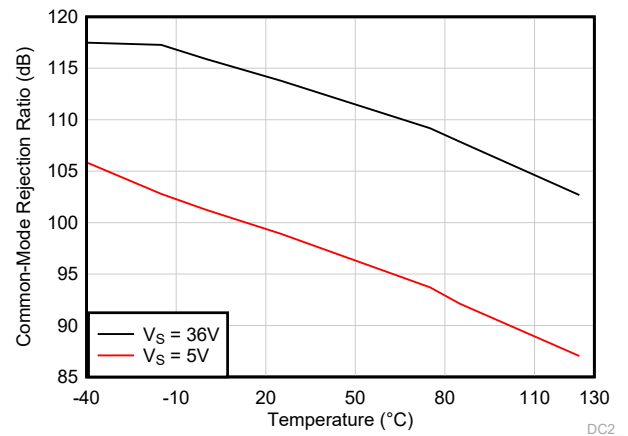

图 6-16. 0.1Hz 至 10Hz 噪声

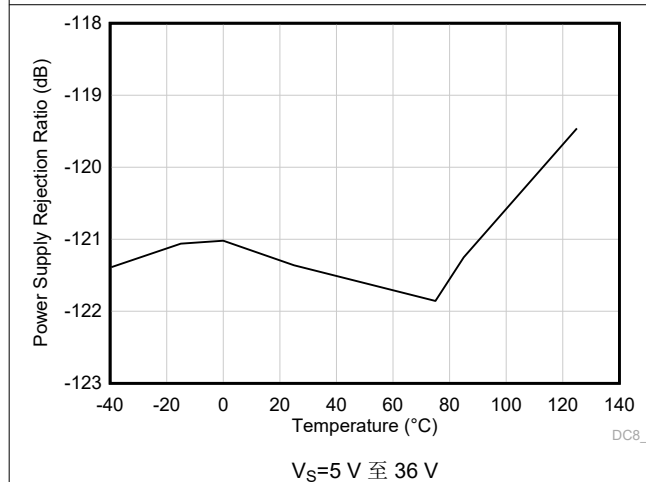

图 6-17. 输入电压噪声频谱密度与频率间的关系

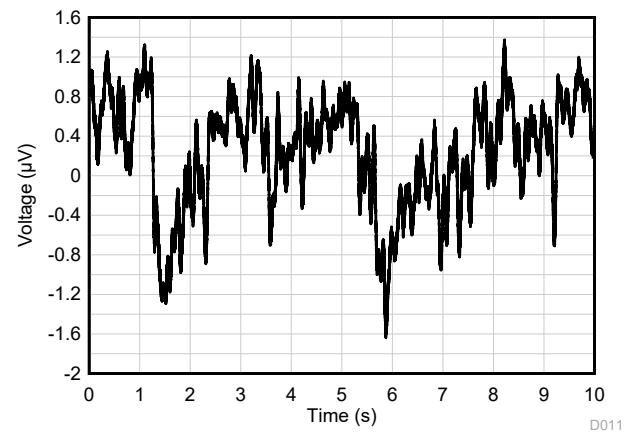

图 6-18. THD+N 比与频率间的关系, $G = 1$

6.11 典型特性：LM358B 和 LM2904B (continued)

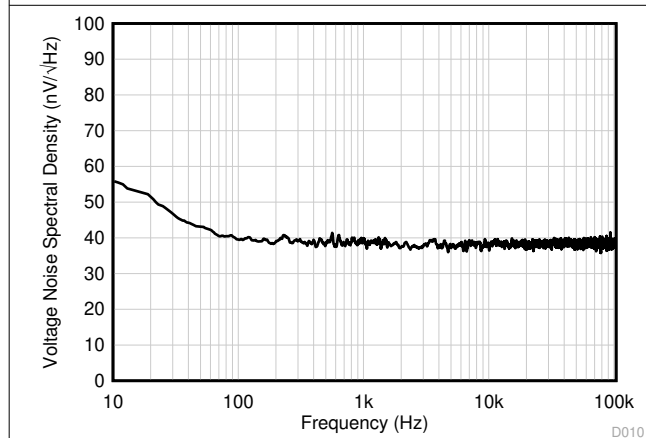
这个典型特性部分适用于 LM358B 和 LM2904B。此部分中的典型特性数据均在 $T_A = 25^\circ\text{C}$ 、 $V_S = 36\text{V} (\pm 18\text{V})$ 、 $V_{CM} = V_S / 2$ 、 $R_{LOAD} = 10\text{k}\Omega$ (连接到 $V_S / 2$) 条件下获得 (除非另有说明)。

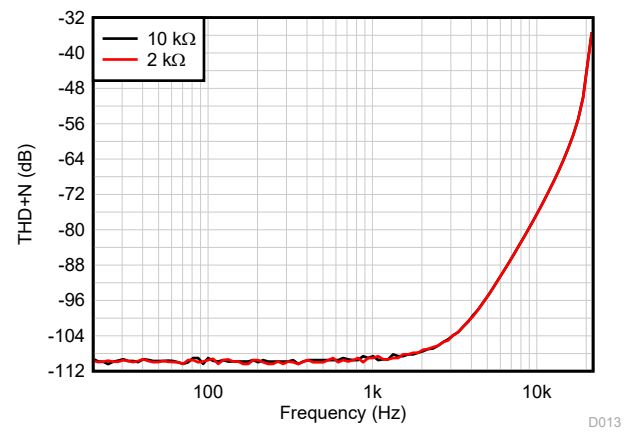
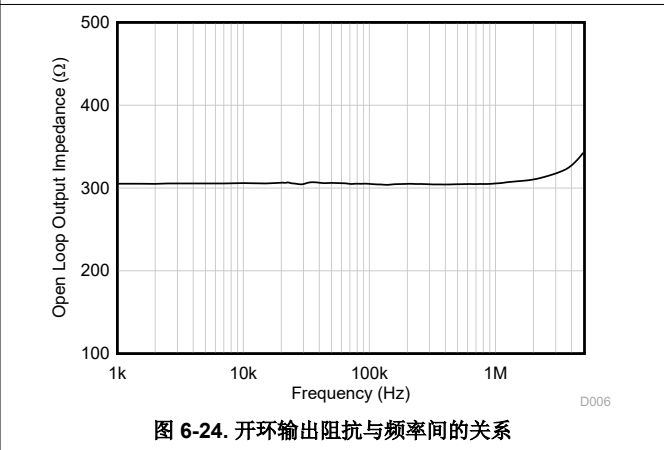
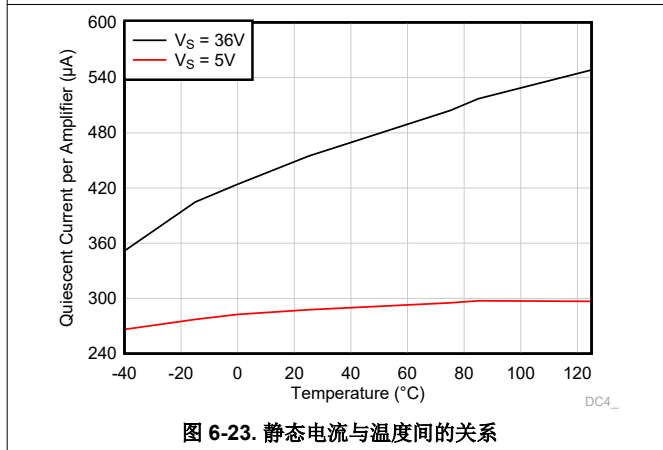
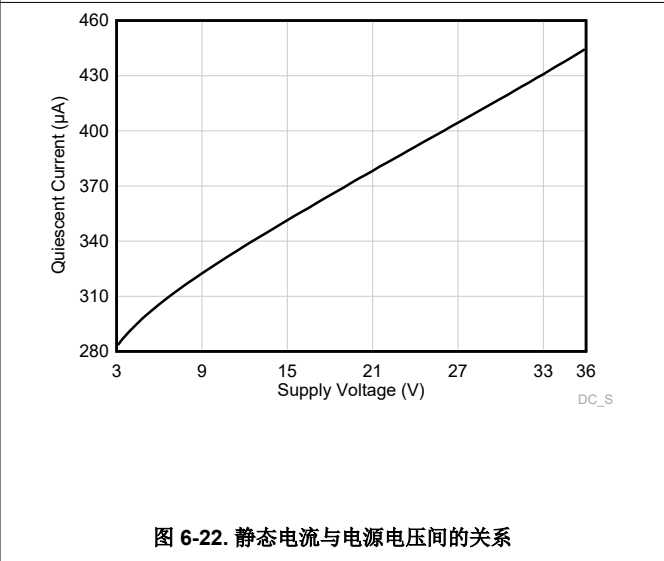
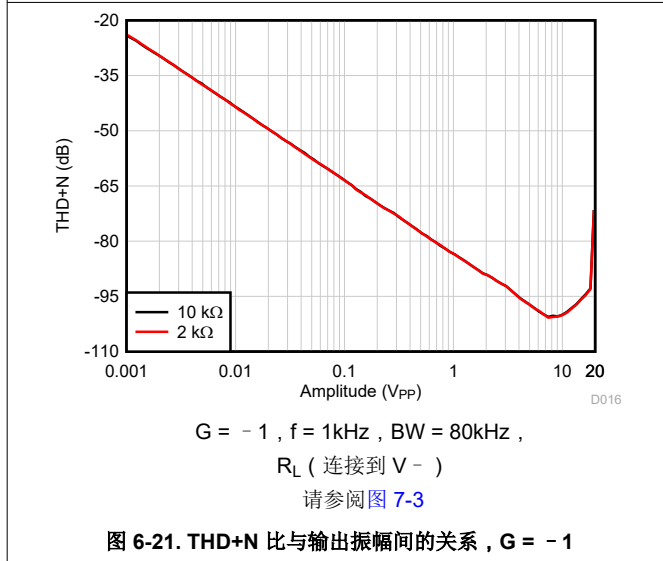
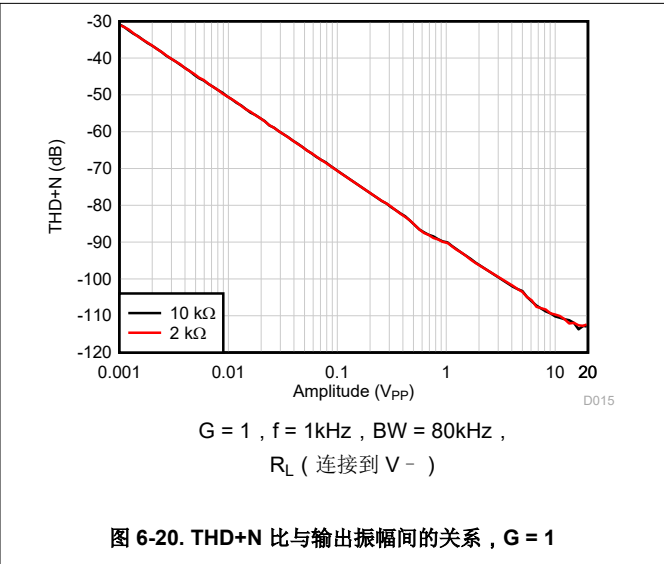
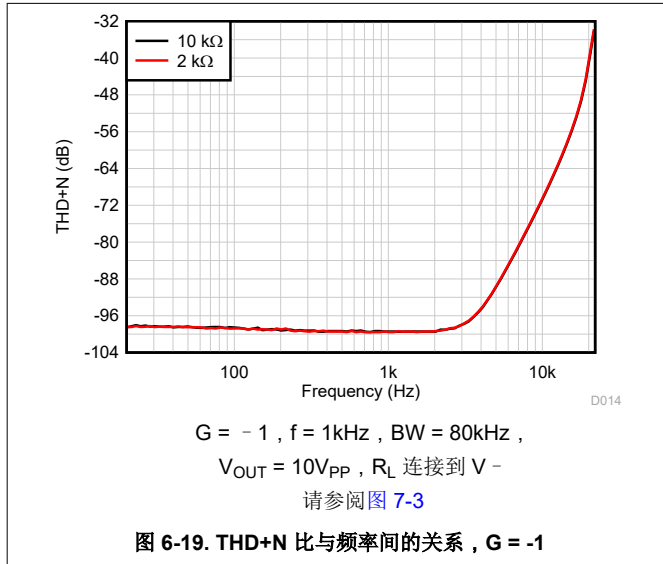

6.11 典型特性：LM358B 和 LM2904B (continued)

这个典型特性部分适用于 LM358B 和 LM2904B。此部分中的典型特性数据均在 $T_A = 25^\circ\text{C}$ 、 $V_S = 36\text{V} (\pm 18\text{V})$ 、 $V_{CM} = V_S / 2$ 、 $R_{LOAD} = 10\text{k}\Omega$ (连接到 $V_S / 2$) 条件下获得 (除非另有说明)。

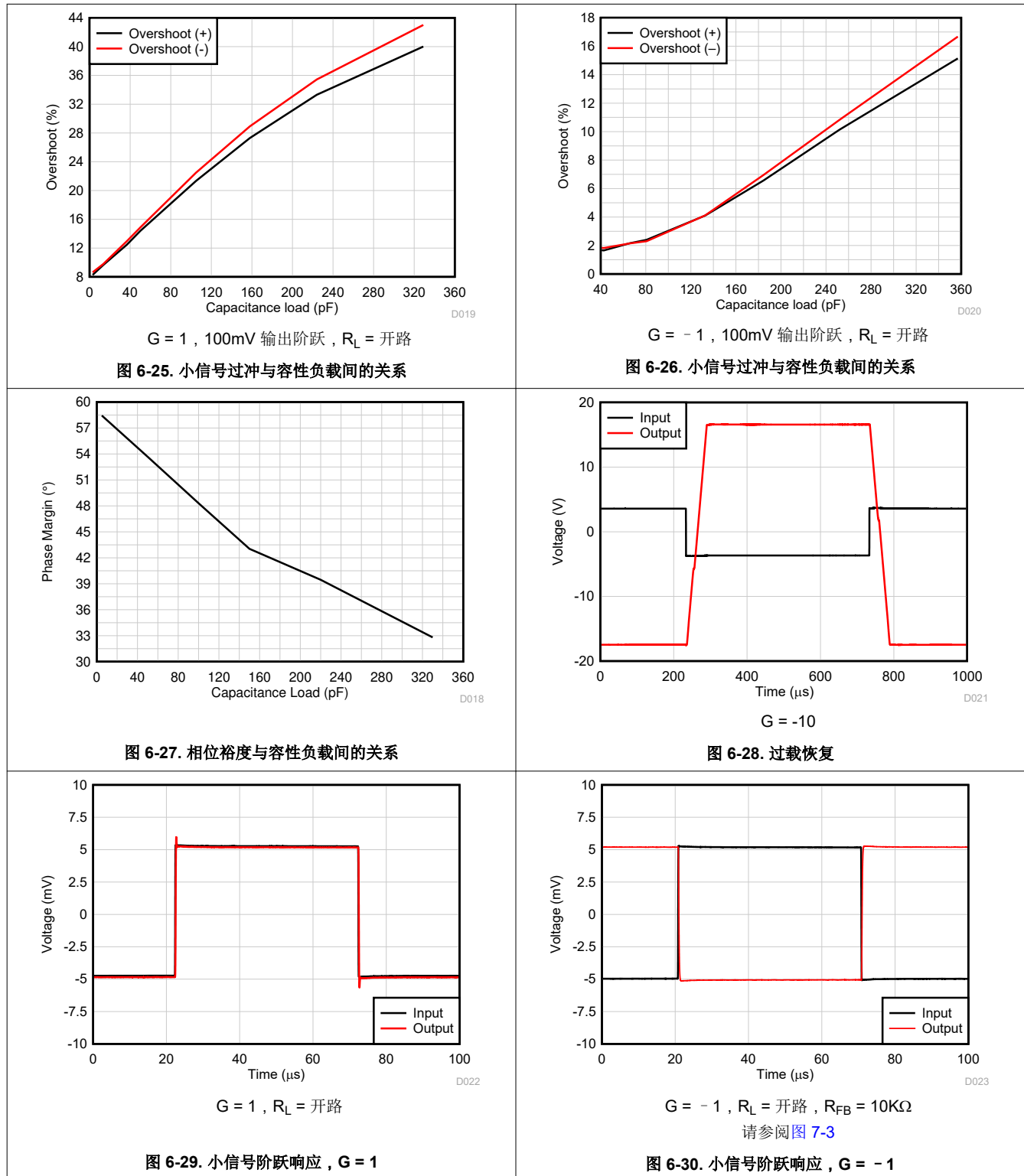

6.11 典型特性：LM358B 和 LM2904B (continued)

这个典型特性部分适用于 LM358B 和 LM2904B。此部分中的典型特性数据均在 $T_A = 25^\circ\text{C}$ 、 $V_S = 36\text{V} (\pm 18\text{V})$ 、 $V_{\text{CM}} = V_S / 2$ 、 $R_{\text{LOAD}} = 10\text{k}\Omega$ (连接到 $V_S / 2$) 条件下获得 (除非另有说明)。

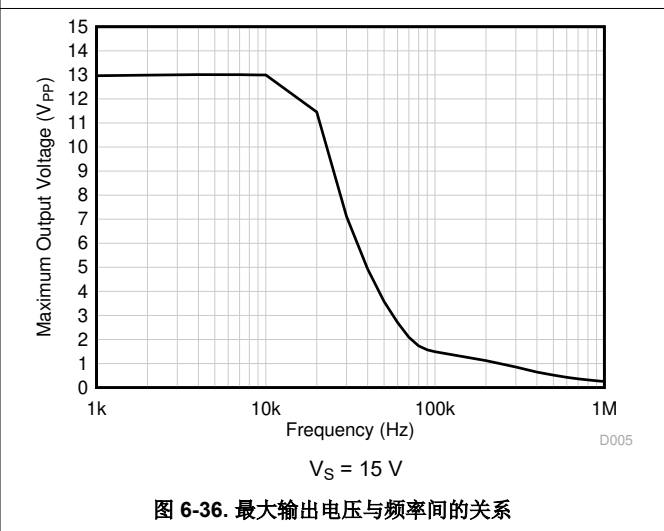
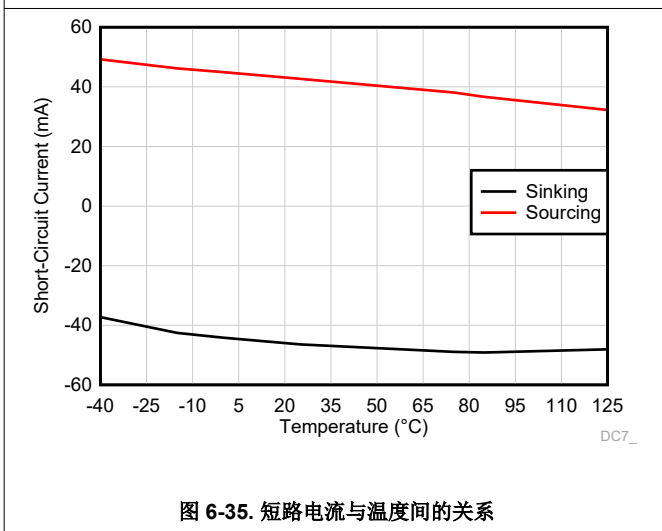
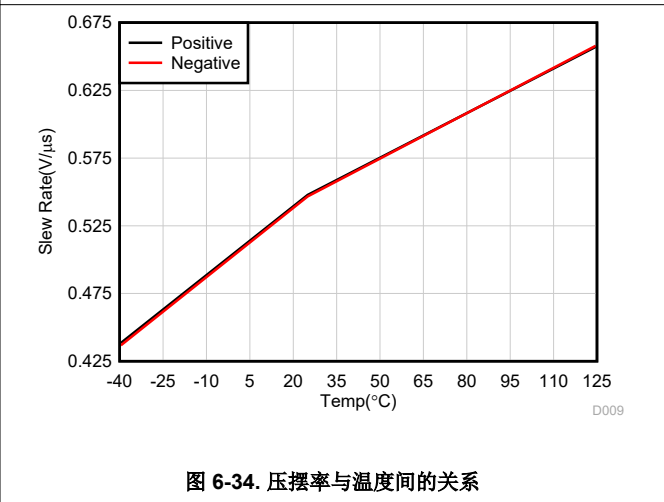
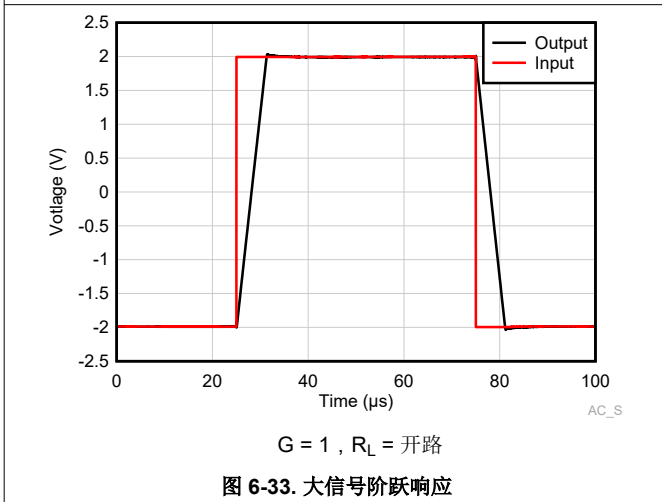
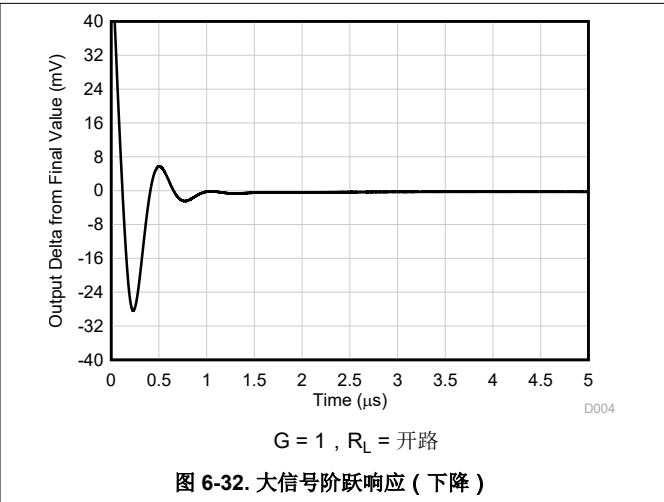
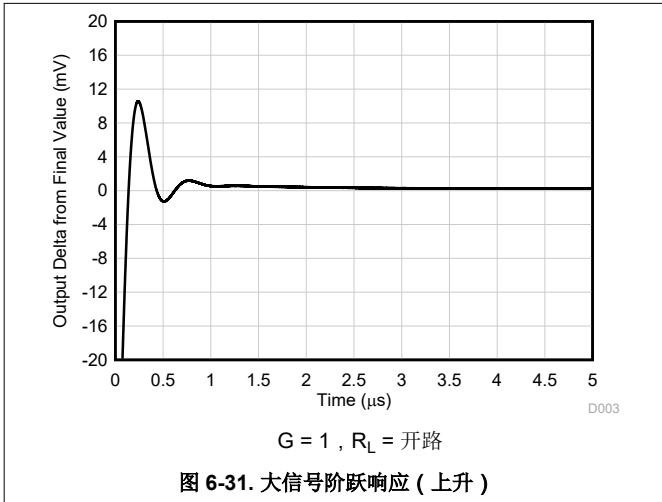

6.11 典型特性：LM358B 和 LM2904B (continued)

这个典型特性部分适用于 LM358B 和 LM2904B。此部分中的典型特性数据均在 $T_A = 25^\circ\text{C}$ 、 $V_S = 36\text{V} (\pm 18\text{V})$ 、 $V_{\text{CM}} = V_S / 2$ 、 $R_{\text{LOAD}} = 10\text{k}\Omega$ (连接到 $V_S / 2$) 条件下获得 (除非另有说明)。

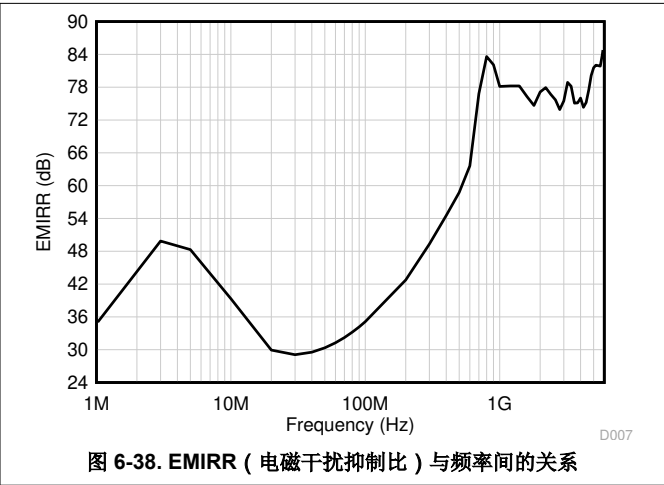
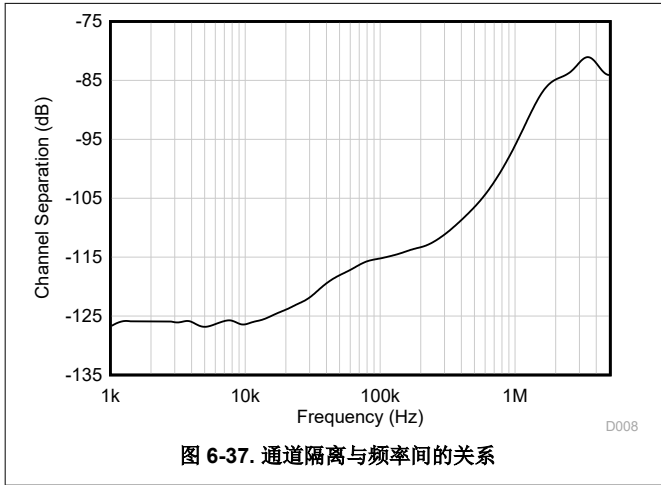

6.12 典型特性：LM158、LM158A、LM258、LM258A、LM358、LM358A、LM2904 和 LM2904V

该典型特性部分适用于 LM158、LM158A、LM258、LM258A、LM358、LM358A、LM2904 和 LM2904V。



图 6-39. 输入电流与温度间的关系



图 6-40. 电源电流与电源电压间的关系

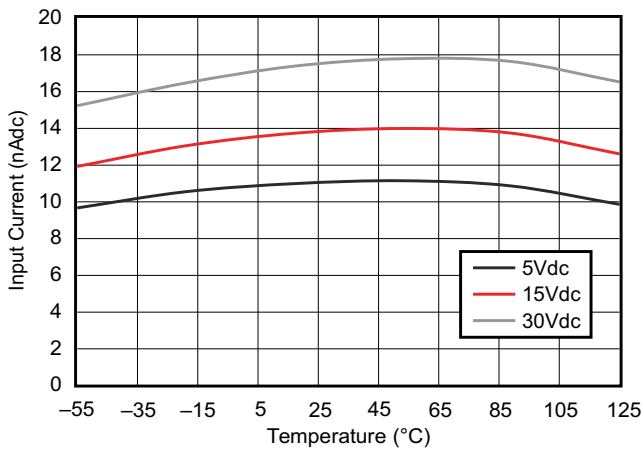

图 6-41. 电压增益与电源电压间的关系

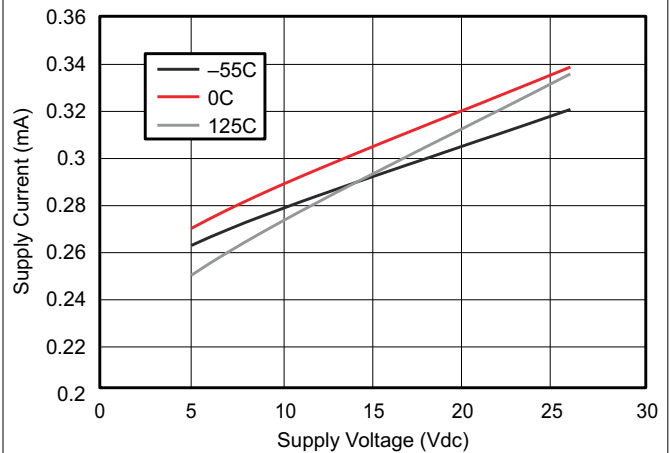

图 6-42. 共模抑制比与频率间的关系

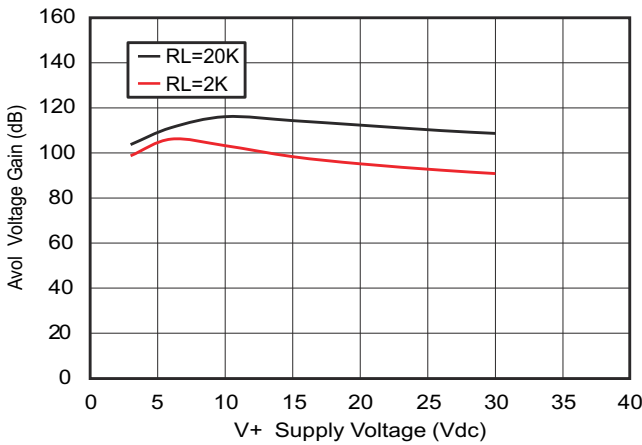

图 6-43. 电压跟随器大信号脉冲响应 (50pF)

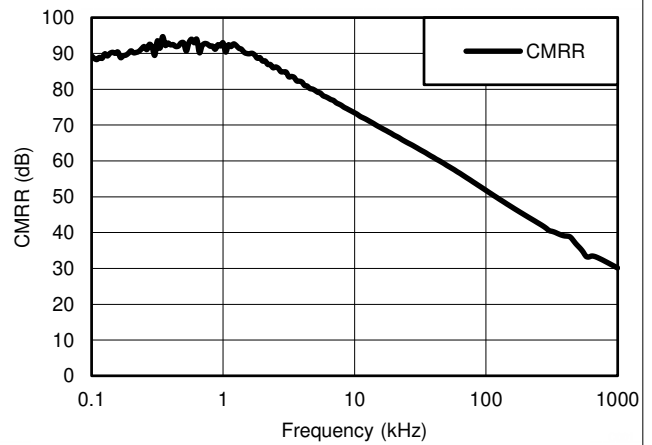

图 6-44. 电压跟随器小信号响应 (50pF)

6.12 典型特性：LM158、LM158A、LM258、LM258A、LM358、LM358A、LM2904 和 LM2904V (continued)

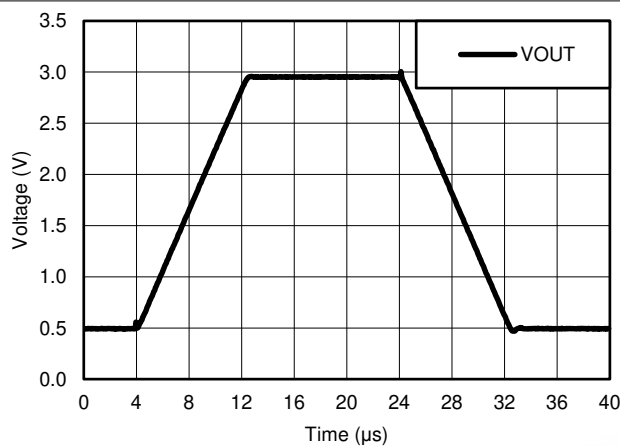
该典型特性部分适用于 LM158、LM158A、LM258、LM258A、LM358、LM358A、LM2904 和 LM2904V。

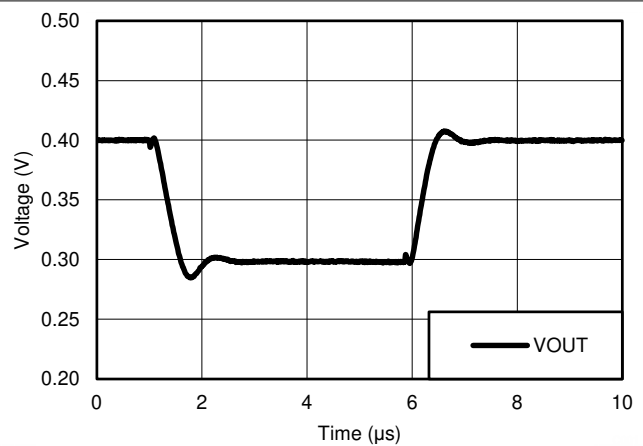

图 6-45. 最大输出摆幅与频率间的关系 ($V_{CC} = 15V$)



图 6-46. 输出拉电流特性

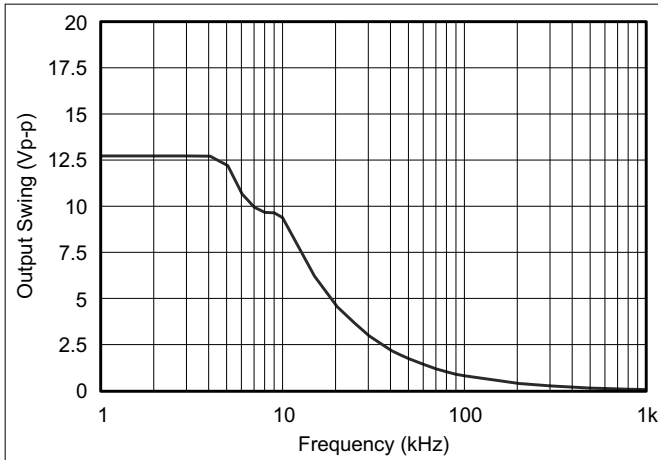

图 6-47. 输出灌电流特性

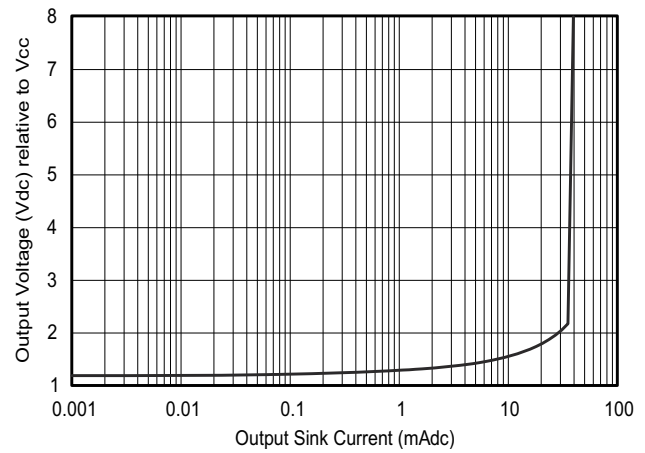

图 6-48. 拉电流限制

7 参数测量信息

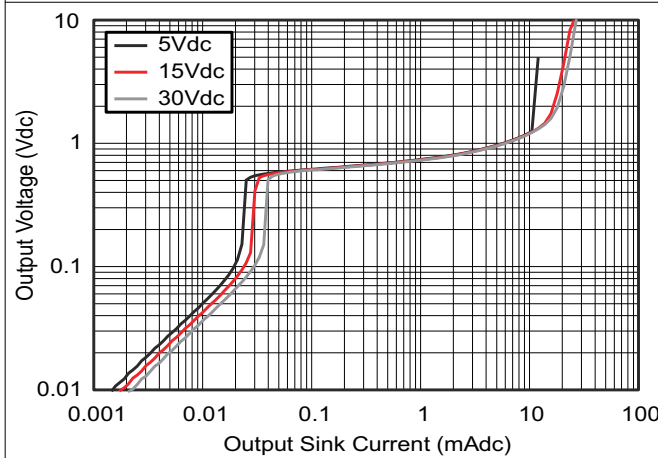

图 7-1. 单位增益放大器

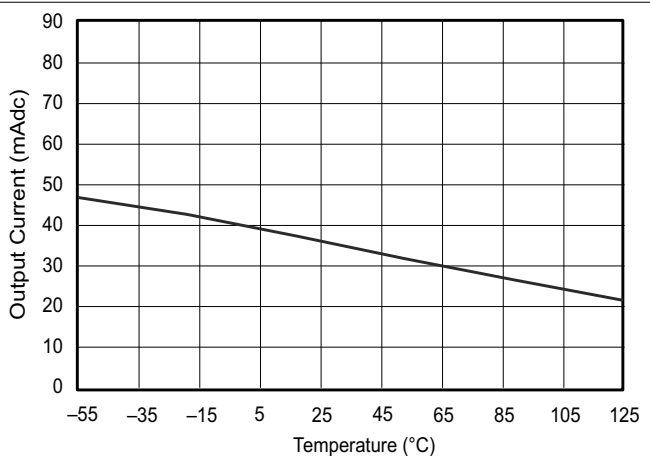

图 7-2. 噪声测试电路

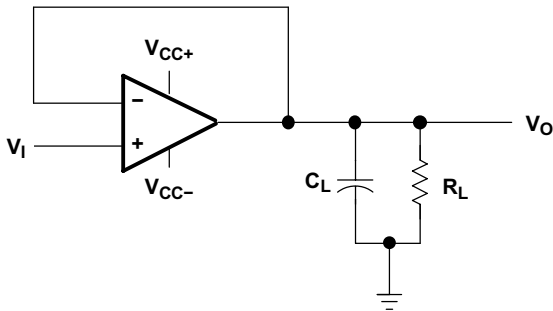

图 7-3. THD+N 和小信号阶跃响应的测试电路 ($G = -1$)

8 详细说明

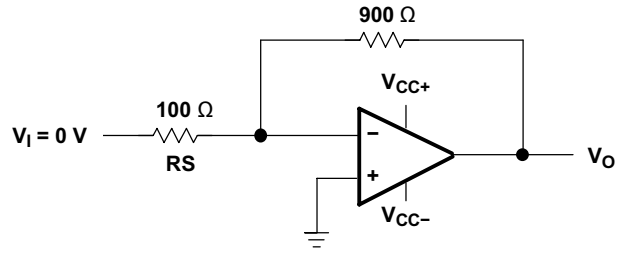
8.1 概述

这些器件包含 2 个独立的高增益频率补偿运算放大器，专为在宽电压范围内使用单电源而设计。如果两个电源之间的电压差在节 6.3 中规定的电源电压范围内且 V_S 比输入共模电压至少高 1.5V，也可使用双电源供电运行。低电源电流漏极与电源电压的幅度无关。

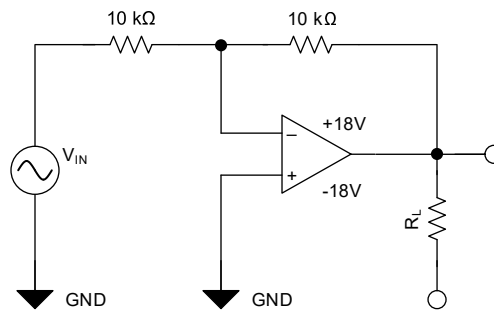
具体应用包括传感器放大器、直流放大块和所有传统运算放大器电路，现在均可在单电源电压系统中轻松实施。例如，这些器件可直接由数字系统使用的标准 5V 电源供电，无需额外的 $\pm 5V$ 电源即可轻松提供所需的接口电子元件。

8.2 功能方框图：LM358B、LM358BA、LM2904B、LM2904BA

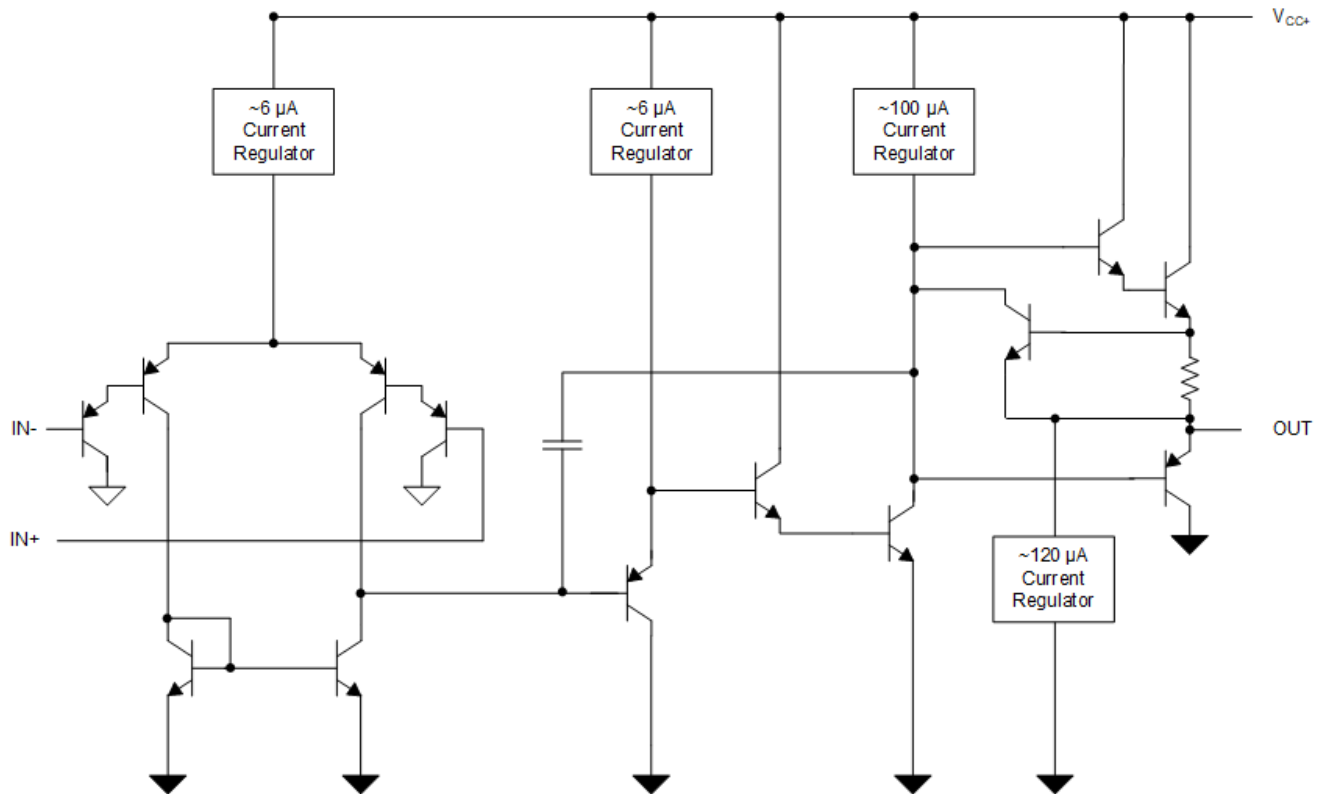

8.3 特性说明

8.3.1 单位增益带宽

单位增益带宽是具有单位增益的放大器可以工作而不会导致信号严重失真的最大频率。这些器件具有 1.2MHz 的单位增益带宽 (B 版本)。

8.3.2 压摆率

压摆率是运算放大器在输入发生变化时可以改变输出的速率。这些器件具有 $0.5V/\mu s$ 的压摆率 (B 版本)。

8.3.3 输入共模范围

有效的共模范围是从器件地到 $V_S - 1.5V$ (在整个温度范围内为 $V_S - 2V$)。输入可能会超过 V_S 直至最大 V_S 而不会损坏器件。至少一个输入必须在有效的输入共模范围内，才能使输出具有正确的相位。如果两个输入都超出有效范围，则输出相位未定义。如果任一输入低于 V^- 超过 $0.3V$ ，则输入电流应限制为 $1mA$ ，并且输出相位未定义。

8.4 器件功能模式

这些器件会在连接电源时加电。该器件可根据应用情况作为单电源运算放大器或双电源放大器使用。

9 应用和实现

备注

以下应用部分中的信息不属于 TI 组件规范，TI 不担保其准确性和完整性。TI 的客户应负责确定各元件是否适用于其应用。客户应验证并测试其设计实现，以确认系统功能。

9.1 应用信息

LMx58 和 LM2904 运算放大器适用于各种信号调节应用。可以在 V_S 之前为输入供电，从而实现多电源电路的灵活性。

9.2 典型应用

运算放大器的典型应用是反相放大器。该放大器在输入端接受正电压，然后使电压变为同样幅度的负电压。它还会以相同的方式使负输入电压变为正电压。



图 9-1. 应用原理图

9.2.1 设计要求

选择的电源电压必须大于输入电压范围和输出范围。例如，此应用将 $\pm 0.5V$ 的信号扩展到了 $\pm 1.8V$ 。将电源设置在 $\pm 12V$ 就足以满足此应用的要求。

9.2.2 详细设计过程

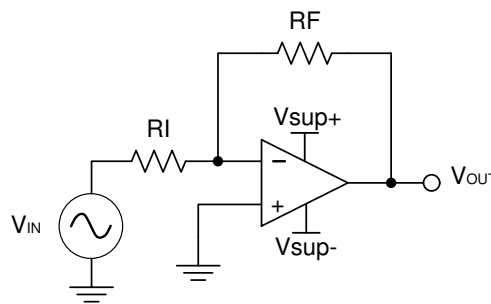
使用 [方程式 1](#) 和 [方程式 2](#) 来确定反相放大器需要的增益：

$$A_V = \frac{V_{OUT}}{V_{IN}} \quad (1)$$

$$A_V = \frac{1.8}{-0.5} = -3.6 \quad (2)$$

确定所需增益后，选择 R_I 或 R_F 的阻值。[下标也应该固定在相应数字和公式上。]由于放大器电路使用毫安级电流，因此通常要选择千欧姆级阻值。这样可以确保该器件不会消耗过多电流。此示例使用的 R_I 为 $10k\Omega$ ，这意味着对 R_F 使用 $36k\Omega$ 。这是由 [方程式 3](#) 算出的。

$$A_V = -\frac{R_F}{R_I} \quad (3)$$

9.2.3 应用曲线



图 9-2. 反相放大器的输入和输出电压

10 电源相关建议

CAUTION

大于推荐额定工作范围的电源电压可能会永久损坏器件（请参阅节 6.1）。

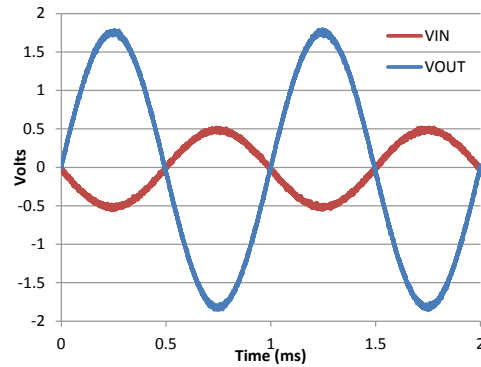
将 $0.1\mu\text{F}$ 旁路电容器置于电源引脚附近，以减少从高噪声电源或高阻抗电源中耦合进来的误差。有关旁路电容器放置的更多详细信息，请参阅节 11。

11 布局

11.1 布局指南

为了实现器件的最佳工作性能，应使用良好的 PCB 布局实践，包括：

- 噪声可通过全部电路电源引脚以及运算放大器自身传入模拟电路。旁路电容用于通过为局部模拟电路提供低阻抗电源，以降低耦合噪声。
 - 在每个电源引脚和接地端之间接入低等效串联电阻 (ESR) $0.1\mu\text{F}$ 陶瓷旁路电容，并尽量靠近器件放置。从 $V+$ 到接地端之间的单个旁路电容适用于单电源应用。
- 将电路中的模拟部分和数字部分单独接地是最简单最有效的噪声抑制方法之一。通常将多层 PCB 中的一层或多层专门作为接地层。接地层有助于散热和降低 EMI 噪声拾取。确保对数字接地和模拟接地进行物理隔离，同时应注意接地电流。
- 为了减少寄生耦合，请让输入走线尽可能远离电源或输出走线。如果这些迹线不能保持分离状态，最好让敏感走线与有噪声的走线垂直相交，而不是平行相交。
- 外部组件的位置应尽量靠近器件。使 R_F 和 R_G 接近反相输入可最大限度地减小寄生电容（如节 11.2 所示）。
- 尽可能缩短输入走线。切记：输入走线是电路中最敏感的部分。
- 考虑在关键走线周围设定驱动型低阻抗保护环。这样可显著减少附近走线在不同电势下产生的漏电流。

11.2 布局示例



图 11-1. 非反相配置的运算放大器电路板布局



图 11-2. 同相配置的运算放大器原理图

12 器件和文档支持

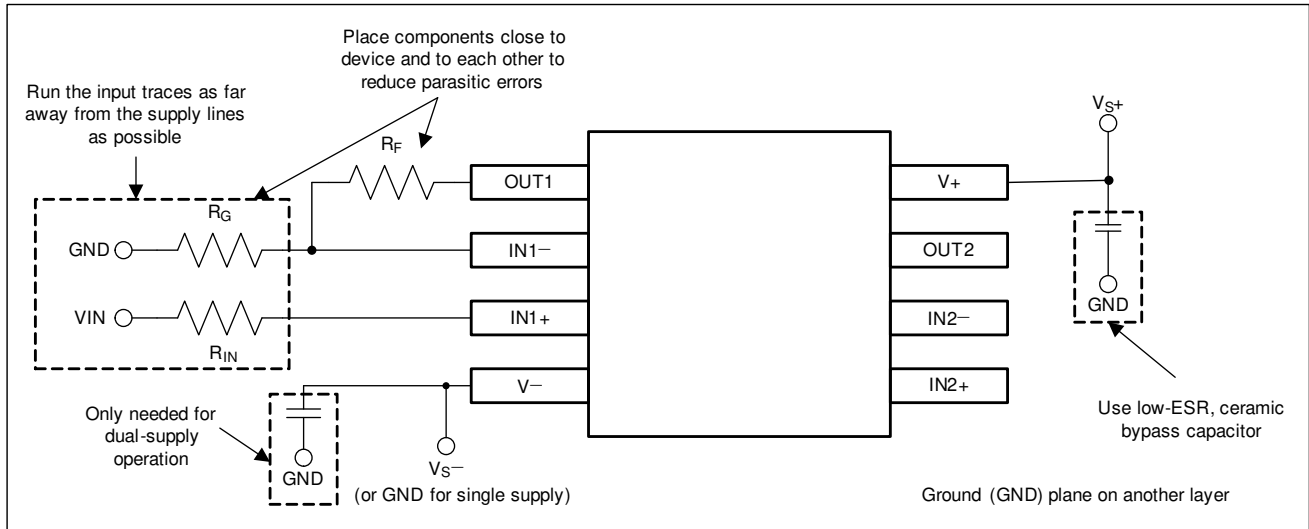
12.1 接收文档更新通知

要接收文档更新通知，请导航至 ti.com 上的器件产品文件夹。点击 [订阅更新](#) 进行注册，即可每周接收产品信息更改摘要。有关更改的详细信息，请查看任何已修订文档中包含的修订历史记录。

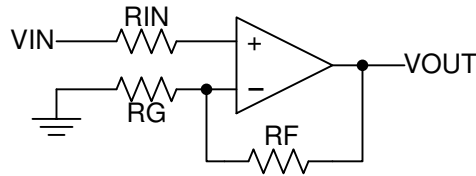
12.2 支持资源

TI E2E™ 支持论坛是工程师的重要参考资料，可直接从专家获得快速、经过验证的解答和设计帮助。搜索现有解答或提出自己的问题可获得所需的快速设计帮助。

链接的内容由各个贡献者“按原样”提供。这些内容并不构成 TI 技术规范，并且不一定反映 TI 的观点；请参阅 TI 的《[使用条款](#)》。

12.3 商标

TI E2E™ is a trademark of Texas Instruments.

所有商标均为其各自所有者的财产。

12.4 Electrostatic Discharge Caution



This integrated circuit can be damaged by ESD. Texas Instruments recommends that all integrated circuits be handled with appropriate precautions. Failure to observe proper handling and installation procedures can cause damage.

ESD damage can range from subtle performance degradation to complete device failure. Precision integrated circuits may be more susceptible to damage because very small parametric changes could cause the device not to meet its published specifications.

12.5 术语表

[TI 术语表](#) 本术语表列出并解释了术语、首字母缩略词和定义。

13 机械、封装和可订购信息

以下页中包括机械、封装和可订购信息。这些信息是针对指定器件可提供的最新数据。数据如有变更，恕不另行通知或修订此文档。如需获取此数据表的浏览器版本，请查看左侧的导航面板。

PACKAGING INFORMATION

Orderable Device	Status (1)	Package Type	Package Drawing	Pins	Package Qty	Eco Plan (2)	Lead finish/ Ball material (6)	MSL Peak Temp (3)	Op Temp (°C)	Device Marking (4/5)	Samples
5962-87710012A	ACTIVE	LCCC	FK	20	55	Non-RoHS & Green	SNPB	N / A for Pkg Type	-55 to 125	5962-87710012A LM158FKB	Samples
5962-8771001PA	ACTIVE	CDIP	JG	8	50	Non-RoHS & Green	SNPB	N / A for Pkg Type	-55 to 125	8771001PA LM158	Samples
5962-87710022A	ACTIVE	LCCC	FK	20	55	Non-RoHS & Green	SNPB	N / A for Pkg Type	-55 to 125	5962-87710022A LM158AFKB	Samples
5962-8771002PA	ACTIVE	CDIP	JG	8	50	Non-RoHS & Green	SNPB	N / A for Pkg Type	-55 to 125	8771002PA LM158A	Samples
LM158 MW8	ACTIVE	WAFERSALE	YS	0	1	RoHS & Green	Call TI	Level-1-NA-UNLIM	-55 to 125		Samples
LM158AFKB	ACTIVE	LCCC	FK	20	55	Non-RoHS & Green	SNPB	N / A for Pkg Type	-55 to 125	5962-87710022A LM158AFKB	Samples
LM158AJG	ACTIVE	CDIP	JG	8	50	Non-RoHS & Green	SNPB	N / A for Pkg Type	-55 to 125	LM158AJG	Samples
LM158AJGB	ACTIVE	CDIP	JG	8	50	Non-RoHS & Green	SNPB	N / A for Pkg Type	-55 to 125	8771002PA LM158A	Samples
LM158FKB	ACTIVE	LCCC	FK	20	55	Non-RoHS & Green	SNPB	N / A for Pkg Type	-55 to 125	5962-87710012A LM158FKB	Samples
LM158JG	ACTIVE	CDIP	JG	8	50	Non-RoHS & Green	SNPB	N / A for Pkg Type	-55 to 125	LM158JG	Samples
LM158JGB	ACTIVE	CDIP	JG	8	50	Non-RoHS & Green	SNPB	N / A for Pkg Type	-55 to 125	8771001PA LM158	Samples
LM258ADGKR	ACTIVE	VSSOP	DGK	8	2500	RoHS & Green	NIPDAU SN NIPDAUAG	Level-1-260C-UNLIM	-25 to 85	(M3L, M3P, M3S, M3U)	Samples
LM258ADR	ACTIVE	SOIC	D	8	2500	RoHS & Green	NIPDAU SN	Level-1-260C-UNLIM	-25 to 85	LM258A	Samples
LM258AP	ACTIVE	PDIP	P	8	50	RoHS & Green	NIPDAU SN	N / A for Pkg Type	-25 to 85	LM258AP	Samples
LM258APE4	ACTIVE	PDIP	P	8	50	RoHS & Green	NIPDAU	N / A for Pkg Type	-25 to 85	LM258AP	Samples

Orderable Device	Status (1)	Package Type	Package Drawing	Pins	Package Qty	Eco Plan (2)	Lead finish/ Ball material (6)	MSL Peak Temp (3)	Op Temp (°C)	Device Marking (4/5)	Samples
LM258DGKR	ACTIVE	VSSOP	DGK	8	2500	RoHS & Green	NIPDAU SN NIPDAUAG	Level-1-260C-UNLIM	-25 to 85	(M2L, M2P, M2S, M2U)	Samples
LM258DR	ACTIVE	SOIC	D	8	2500	RoHS & Green	NIPDAU SN	Level-1-260C-UNLIM	-25 to 85	LM258	Samples
LM258DRG3	LIFEBUY	SOIC	D	8	2500	RoHS & Green	SN	Level-1-260C-UNLIM	-25 to 85	LM258	
LM258DRG4	ACTIVE	SOIC	D	8	2500	RoHS & Green	NIPDAU	Level-1-260C-UNLIM	-25 to 85	LM258	Samples
LM258P	ACTIVE	PDIP	P	8	50	RoHS & Green	NIPDAU SN	N / A for Pkg Type	-25 to 85	LM258P	Samples
LM258PE4	ACTIVE	PDIP	P	8	50	RoHS & Green	NIPDAU	N / A for Pkg Type	-25 to 85	LM258P	Samples
LM2904AVQDR	ACTIVE	SOIC	D	8	2500	RoHS & Green	NIPDAU	Level-1-260C-UNLIM	-40 to 125	L2904AV	Samples
LM2904AVQDRG4	ACTIVE	SOIC	D	8	2500	RoHS & Green	NIPDAU	Level-1-260C-UNLIM	-40 to 125	L2904AV	Samples
LM2904AVQPWR	ACTIVE	TSSOP	PW	8	2000	RoHS & Green	NIPDAU	Level-1-260C-UNLIM	-40 to 125	L2904AV	Samples
LM2904AVQPWRG4	ACTIVE	TSSOP	PW	8	2000	RoHS & Green	NIPDAU	Level-1-260C-UNLIM	-40 to 125	L2904AV	Samples
LM2904BAIDDFR	ACTIVE	SOT-23-THIN	DDF	8	3000	RoHS & Green	NIPDAU	Level-1-260C-UNLIM	-40 to 125	2904A	Samples
LM2904BAIDGKR	ACTIVE	VSSOP	DGK	8	2500	RoHS & Green	SN	Level-1-260C-UNLIM	-40 to 125	28CB	Samples
LM2904BAIDR	ACTIVE	SOIC	D	8	2500	RoHS & Green	NIPDAU	Level-1-260C-UNLIM	-40 to 125	2904BA	Samples
LM2904BAIPWR	ACTIVE	TSSOP	PW	8	2000	RoHS & Green	NIPDAU	Level-1-260C-UNLIM	-40 to 125	2904BA	Samples
LM2904BIDDFR	ACTIVE	SOT-23-THIN	DDF	8	3000	RoHS & Green	NIPDAU	Level-1-260C-UNLIM	-40 to 125	L2904	Samples
LM2904BIDGKR	ACTIVE	VSSOP	DGK	8	2500	RoHS & Green	SN	Level-1-260C-UNLIM	-40 to 125	28BB	Samples
LM2904BIDR	ACTIVE	SOIC	D	8	2500	RoHS & Green	NIPDAU	Level-1-260C-UNLIM	-40 to 125	L2904B	Samples
LM2904BIPWR	ACTIVE	TSSOP	PW	8	2000	RoHS & Green	NIPDAU	Level-1-260C-UNLIM	-40 to 125	L2904B	Samples
LM2904DE4	NRND				75	TBD	Call TI	Call TI	-40 to 125		
LM2904DGKR	ACTIVE	VSSOP	DGK	8	2500	RoHS & Green	NIPDAU SN NIPDAUAG	Level-1-260C-UNLIM	-40 to 125	(MBL, MBP, MBS, MBU)	Samples
LM2904DR	ACTIVE	SOIC	D	8	2500	RoHS & Green	NIPDAU SN	Level-1-260C-UNLIM	-40 to 125	LM2904	Samples
LM2904DRE4	LIFEBUY	SOIC	D	8	2500	RoHS & Green	NIPDAU	Level-1-260C-UNLIM	-40 to 125	LM2904	

Orderable Device	Status (1)	Package Type	Package Drawing	Pins	Package Qty	Eco Plan (2)	Lead finish/ Ball material (6)	MSL Peak Temp (3)	Op Temp (°C)	Device Marking (4/5)	Samples
LM2904DRG3	LIFEBUY	SOIC	D	8	2500	RoHS & Green	SN	Level-1-260C-UNLIM	-40 to 125	LM2904	
LM2904DRG4	LIFEBUY	SOIC	D	8	2500	RoHS & Green	NIPDAU	Level-1-260C-UNLIM	-40 to 125	LM2904	
LM2904P	ACTIVE	PDIP	P	8	50	RoHS & Green	NIPDAU SN	N / A for Pkg Type	-40 to 125	LM2904P	Samples
LM2904PE4	ACTIVE	PDIP	P	8	50	RoHS & Green	NIPDAU	N / A for Pkg Type	-40 to 125	LM2904P	Samples
LM2904PSR	LIFEBUY	SO	PS	8	2000	RoHS & Green	NIPDAU	Level-1-260C-UNLIM	-40 to 125	L2904	
LM2904PSR-JF	LIFEBUY	SO	PS	8	2000	RoHS & Green	NIPDAU	Level-1-260C-UNLIM	-40 to 125	L2904	
LM2904PWR	ACTIVE	TSSOP	PW	8	2000	RoHS & Green	NIPDAU SN	Level-1-260C-UNLIM	-40 to 125	L2904	Samples
LM2904PWR-JF	LIFEBUY	TSSOP	PW	8	2000	RoHS & Green	NIPDAU SN	Level-1-260C-UNLIM	-40 to 125	L2904	
LM2904PWRG3	LIFEBUY	TSSOP	PW	8	2000	RoHS & Green	SN	Level-1-260C-UNLIM	-40 to 125	L2904	
LM2904PWRG4	LIFEBUY	TSSOP	PW	8	2000	RoHS & Green	NIPDAU	Level-1-260C-UNLIM	-40 to 125	L2904	
LM2904PWRG4-JF	LIFEBUY	TSSOP	PW	8	2000	RoHS & Green	NIPDAU	Level-1-260C-UNLIM	-40 to 125	L2904	
LM2904QDR	ACTIVE	SOIC	D	8	2500	RoHS & Green	NIPDAU	Level-1-260C-UNLIM	-40 to 125	2904Q1	Samples
LM2904QDRG4	LIFEBUY	SOIC	D	8	2500	RoHS & Green	NIPDAU	Level-1-260C-UNLIM	-40 to 125	2904Q1	
LM2904VQDR	ACTIVE	SOIC	D	8	2500	RoHS & Green	NIPDAU	Level-1-260C-UNLIM	-40 to 125	L2904V	Samples
LM2904VQDRG4	ACTIVE	SOIC	D	8	2500	RoHS & Green	NIPDAU	Level-1-260C-UNLIM	-40 to 125	L2904V	Samples
LM2904VQPWR	ACTIVE	TSSOP	PW	8	2000	RoHS & Green	NIPDAU	Level-1-260C-UNLIM	-40 to 125	L2904V	Samples
LM2904VQPWRG4	ACTIVE	TSSOP	PW	8	2000	RoHS & Green	NIPDAU	Level-1-260C-UNLIM	-40 to 125	L2904V	Samples
LM358ADE4	NRND				75	TBD	Call TI	Call TI	0 to 70		
LM358ADGKR	ACTIVE	VSSOP	DGK	8	2500	RoHS & Green	NIPDAU SN NIPDAUAG	Level-1-260C-UNLIM	0 to 70	(M6L, M6P, M6S, M6U)	Samples
LM358ADR	ACTIVE	SOIC	D	8	2500	RoHS & Green	NIPDAU SN	Level-1-260C-UNLIM	0 to 70	LM358A	Samples
LM358ADRE4	LIFEBUY	SOIC	D	8	2500	RoHS & Green	NIPDAU	Level-1-260C-UNLIM	0 to 70	LM358A	
LM358ADRG4	LIFEBUY	SOIC	D	8	2500	RoHS & Green	NIPDAU	Level-1-260C-UNLIM	0 to 70	LM358A	
LM358AP	ACTIVE	PDIP	P	8	50	RoHS & Green	NIPDAU SN	N / A for Pkg Type	0 to 70	LM358AP	Samples
LM358APE4	ACTIVE	PDIP	P	8	50	RoHS & Green	NIPDAU	N / A for Pkg Type	0 to 70	LM358AP	Samples
LM358APW	LIFEBUY	TSSOP	PW	8	150	RoHS & Green	NIPDAU	Level-1-260C-UNLIM	0 to 70	L358A	

Orderable Device	Status (1)	Package Type	Package Drawing	Pins	Package Qty	Eco Plan (2)	Lead finish/ Ball material (6)	MSL Peak Temp (3)	Op Temp (°C)	Device Marking (4/5)	Samples
LM358APWR	ACTIVE	TSSOP	PW	8	2000	RoHS & Green	NIPDAU SN	Level-1-260C-UNLIM	0 to 70	L358A	Samples
LM358APWRG4	LIFEBUY	TSSOP	PW	8	2000	RoHS & Green	NIPDAU	Level-1-260C-UNLIM	0 to 70	L358A	
LM358BAIDDFR	ACTIVE	SOT-23-THIN	DDF	8	3000	RoHS & Green	NIPDAU	Level-1-260C-UNLIM	-40 to 85	358BA	Samples
LM358BAIDGKR	ACTIVE	VSSOP	DGK	8	2500	RoHS & Green	SN	Level-1-260C-UNLIM	-40 to 85	28DB	Samples
LM358BAIDR	ACTIVE	SOIC	D	8	2500	RoHS & Green	NIPDAU	Level-1-260C-UNLIM	-40 to 85	L358BA	Samples
LM358BAIPWR	ACTIVE	TSSOP	PW	8	2000	RoHS & Green	NIPDAU	Level-1-260C-UNLIM	-40 to 85	L358BA	Samples
LM358BIDDFR	ACTIVE	SOT-23-THIN	DDF	8	3000	RoHS & Green	NIPDAU	Level-1-260C-UNLIM	-40 to 85	LM358	Samples
LM358BIDGKR	ACTIVE	VSSOP	DGK	8	2500	RoHS & Green	SN	Level-1-260C-UNLIM	-40 to 85	358B	Samples
LM358BIDR	ACTIVE	SOIC	D	8	2500	RoHS & Green	NIPDAU	Level-1-260C-UNLIM	-40 to 85	LM358B	Samples
LM358BIPWR	ACTIVE	TSSOP	PW	8	2000	RoHS & Green	NIPDAU	Level-1-260C-UNLIM	-40 to 85	LM358B	Samples
LM358DGKR	ACTIVE	VSSOP	DGK	8	2500	RoHS & Green	NIPDAU SN NIPDAUAG	Level-1-260C-UNLIM	0 to 70	(M5L, M5P, M5S, M5 U)	Samples
LM358DR	ACTIVE	SOIC	D	8	2500	RoHS & Green	NIPDAU	Level-1-260C-UNLIM	0 to 70	LM358	Samples
LM358DRE4	LIFEBUY	SOIC	D	8	2500	RoHS & Green	NIPDAU	Level-1-260C-UNLIM	0 to 70	LM358	
LM358DRG3	LIFEBUY	SOIC	D	8	2500	RoHS & Green	SN	Level-1-260C-UNLIM	0 to 70	LM358	
LM358DRG4	LIFEBUY	SOIC	D	8	2500	RoHS & Green	NIPDAU	Level-1-260C-UNLIM	0 to 70	LM358	
LM358P	ACTIVE	PDIP	P	8	50	RoHS & Green	NIPDAU SN	N / A for Pkg Type	0 to 70	LM358P	Samples
LM358PE3	LIFEBUY	PDIP	P	8	50	RoHS & Non-Green	SN	N / A for Pkg Type	0 to 70	LM358P	
LM358PE4	ACTIVE	PDIP	P	8	50	RoHS & Green	NIPDAU	N / A for Pkg Type	0 to 70	LM358P	Samples
LM358PS-JF	LIFEBUY	SO	PS	8	80	RoHS & Green	NIPDAU	Level-1-260C-UNLIM	0 to 70	L358	
LM358PSR	LIFEBUY	SO	PS	8	2000	RoHS & Green	NIPDAU	Level-1-260C-UNLIM	0 to 70	L358	
LM358PSR-JF	LIFEBUY	SO	PS	8	2000	RoHS & Green	NIPDAU	Level-1-260C-UNLIM	0 to 70	L358	
LM358PW	LIFEBUY	TSSOP	PW	8	150	RoHS & Green	NIPDAU	Level-1-260C-UNLIM	0 to 70	L358	
LM358PW-JF	LIFEBUY	TSSOP	PW	8	150	RoHS & Green	NIPDAU	Level-1-260C-UNLIM	0 to 70	L358	

Orderable Device	Status (1)	Package Type	Package Drawing	Pins	Package Qty	Eco Plan (2)	Lead finish/ Ball material (6)	MSL Peak Temp (3)	Op Temp (°C)	Device Marking (4/5)	Samples
LM358PWR	ACTIVE	TSSOP	PW	8	2000	RoHS & Green	NIPDAU SN	Level-1-260C-UNLIM	0 to 70	L358	Samples
LM358PWR-JF	LIFEBUY	TSSOP	PW	8	2000	RoHS & Green	NIPDAU SN	Level-1-260C-UNLIM	0 to 70	L358	
LM358PWRG3	LIFEBUY	TSSOP	PW	8	2000	RoHS & Green	SN	Level-1-260C-UNLIM	0 to 70	L358	
LM358PWRG4	LIFEBUY	TSSOP	PW	8	2000	RoHS & Green	NIPDAU	Level-1-260C-UNLIM	0 to 70	L358	
LM358PWRG4-JF	LIFEBUY	TSSOP	PW	8	2000	RoHS & Green	NIPDAU	Level-1-260C-UNLIM	0 to 70	L358	

(1) The marketing status values are defined as follows:

ACTIVE: Product device recommended for new designs.

LIFEBUY: TI has announced that the device will be discontinued, and a lifetime-buy period is in effect.

NRND: Not recommended for new designs. Device is in production to support existing customers, but TI does not recommend using this part in a new design.

PREVIEW: Device has been announced but is not in production. Samples may or may not be available.

OBSELETE: TI has discontinued the production of the device.

(2) **RoHS:** TI defines "RoHS" to mean semiconductor products that are compliant with the current EU RoHS requirements for all 10 RoHS substances, including the requirement that RoHS substance do not exceed 0.1% by weight in homogeneous materials. Where designed to be soldered at high temperatures, "RoHS" products are suitable for use in specified lead-free processes. TI may reference these types of products as "Pb-Free".

RoHS Exempt: TI defines "RoHS Exempt" to mean products that contain lead but are compliant with EU RoHS pursuant to a specific EU RoHS exemption.

Green: TI defines "Green" to mean the content of Chlorine (Cl) and Bromine (Br) based flame retardants meet JS709B low halogen requirements of <=1000ppm threshold. Antimony trioxide based flame retardants must also meet the <=1000ppm threshold requirement.

(3) MSL, Peak Temp. - The Moisture Sensitivity Level rating according to the JEDEC industry standard classifications, and peak solder temperature.

(4) There may be additional marking, which relates to the logo, the lot trace code information, or the environmental category on the device.

(5) Multiple Device Markings will be inside parentheses. Only one Device Marking contained in parentheses and separated by a "~" will appear on a device. If a line is indented then it is a continuation of the previous line and the two combined represent the entire Device Marking for that device.

(6) Lead finish/Ball material - Orderable Devices may have multiple material finish options. Finish options are separated by a vertical ruled line. Lead finish/Ball material values may wrap to two lines if the finish value exceeds the maximum column width.

Important Information and Disclaimer:The information provided on this page represents TI's knowledge and belief as of the date that it is provided. TI bases its knowledge and belief on information provided by third parties, and makes no representation or warranty as to the accuracy of such information. Efforts are underway to better integrate information from third parties. TI has taken and continues to take reasonable steps to provide representative and accurate information but may not have conducted destructive testing or chemical analysis on incoming materials and chemicals. TI and TI suppliers consider certain information to be proprietary, and thus CAS numbers and other limited information may not be available for release.

In no event shall TI's liability arising out of such information exceed the total purchase price of the TI part(s) at issue in this document sold by TI to Customer on an annual basis.

OTHER QUALIFIED VERSIONS OF LM258A, LM2904, LM2904B, LM2904BA :

- Automotive : [LM2904-Q1](#), [LM2904B-Q1](#), [LM2904BA-Q1](#)
- Enhanced Product : [LM258A-EP](#), [LM2904-EP](#)

NOTE: Qualified Version Definitions:

- Automotive - Q100 devices qualified for high-reliability automotive applications targeting zero defects
- Enhanced Product - Supports Defense, Aerospace and Medical Applications

TAPE AND REEL INFORMATION

QUADRANT ASSIGNMENTS FOR PIN 1 ORIENTATION IN TAPE

*All dimensions are nominal

Device	Package Type	Package Drawing	Pins	SPQ	Reel Diameter (mm)	Reel Width W1 (mm)	A0 (mm)	B0 (mm)	K0 (mm)	P1 (mm)	W (mm)	Pin1 Quadrant
LM258ADGKR	VSSOP	DGK	8	2500	330.0	12.4	5.3	3.4	1.4	8.0	12.0	Q1
LM258ADR	SOIC	D	8	2500	330.0	12.8	6.4	5.2	2.1	8.0	12.0	Q1
LM258ADR	SOIC	D	8	2500	330.0	12.4	6.4	5.2	2.1	8.0	12.0	Q1
LM258ADR	SOIC	D	8	2500	330.0	12.4	6.4	5.2	2.1	8.0	12.0	Q1
LM258DGKR	VSSOP	DGK	8	2500	330.0	12.4	5.3	3.4	1.4	8.0	12.0	Q1
LM258DR	SOIC	D	8	2500	330.0	12.8	6.4	5.2	2.1	8.0	12.0	Q1
LM258DR	SOIC	D	8	2500	330.0	12.4	6.4	5.2	2.1	8.0	12.0	Q1
LM258DR	SOIC	D	8	2500	330.0	12.4	6.4	5.2	2.1	8.0	12.0	Q1
LM258DRG3	SOIC	D	8	2500	330.0	12.8	6.4	5.2	2.1	8.0	12.0	Q1
LM258DRG4	SOIC	D	8	2500	330.0	12.4	6.4	5.2	2.1	8.0	12.0	Q1
LM258DRG4	SOIC	D	8	2500	330.0	12.4	6.4	5.2	2.1	8.0	12.0	Q1
LM258DRG4	SOIC	D	8	2500	330.0	12.4	6.4	5.2	2.1	8.0	12.0	Q1
LM258DRG4	SOIC	D	8	2500	330.0	12.4	6.4	5.2	2.1	8.0	12.0	Q1
LM2904AVQDR	SOIC	D	8	2500	330.0	12.5	6.4	5.2	2.1	8.0	12.0	Q1
LM2904AVQDR	SOIC	D	8	2500	330.0	12.4	6.4	5.2	2.1	8.0	12.0	Q1
LM2904AVQDRG4	SOIC	D	8	2500	330.0	12.5	6.4	5.2	2.1	8.0	12.0	Q1

Device	Package Type	Package Drawing	Pins	SPQ	Reel Diameter (mm)	Reel Width W1 (mm)	A0 (mm)	B0 (mm)	K0 (mm)	P1 (mm)	W (mm)	Pin1 Quadrant
LM2904AVQDRG4	SOIC	D	8	2500	330.0	12.4	6.4	5.2	2.1	8.0	12.0	Q1
LM2904AVQPWR	TSSOP	PW	8	2000	330.0	12.4	7.0	3.6	1.6	8.0	12.0	Q1
LM2904AVQPWR	TSSOP	PW	8	2000	330.0	12.4	7.0	3.6	1.6	8.0	12.0	Q1
LM2904AVQPWRG4	TSSOP	PW	8	2000	330.0	12.4	7.0	3.6	1.6	8.0	12.0	Q1
LM2904AVQPWRG4	TSSOP	PW	8	2000	330.0	12.4	7.0	3.6	1.6	8.0	12.0	Q1
LM2904BAIDDFR	SOT-23-THIN	DDF	8	3000	180.0	8.4	3.2	3.2	1.4	4.0	8.0	Q3
LM2904BAIDGKR	VSSOP	DGK	8	2500	330.0	12.4	5.3	3.4	1.4	8.0	12.0	Q1
LM2904BAIDR	SOIC	D	8	2500	330.0	12.4	6.4	5.2	2.1	8.0	12.0	Q1
LM2904BAIPWR	TSSOP	PW	8	2000	330.0	12.4	7.0	3.6	1.6	8.0	12.0	Q1
LM2904BIDDFR	SOT-23-THIN	DDF	8	3000	180.0	8.4	3.2	3.2	1.4	4.0	8.0	Q3
LM2904BIDGKR	VSSOP	DGK	8	2500	330.0	12.4	5.3	3.4	1.4	8.0	12.0	Q1
LM2904BIDR	SOIC	D	8	2500	330.0	12.4	6.4	5.2	2.1	8.0	12.0	Q1
LM2904BIPWR	TSSOP	PW	8	2000	330.0	12.4	7.0	3.6	1.6	8.0	12.0	Q1
LM2904DGKR	VSSOP	DGK	8	2500	330.0	12.4	5.3	3.4	1.4	8.0	12.0	Q1
LM2904DGKR	VSSOP	DGK	8	2500	330.0	12.4	5.3	3.4	1.4	8.0	12.0	Q1
LM2904DR	SOIC	D	8	2500	330.0	12.8	6.4	5.2	2.1	8.0	12.0	Q1
LM2904DR	SOIC	D	8	2500	330.0	12.4	6.4	5.2	2.1	8.0	12.0	Q1
LM2904DR	SOIC	D	8	2500	330.0	12.4	6.4	5.2	2.1	8.0	12.0	Q1
LM2904DRG3	SOIC	D	8	2500	330.0	12.8	6.4	5.2	2.1	8.0	12.0	Q1
LM2904DRG4	SOIC	D	8	2500	330.0	12.4	6.4	5.2	2.1	8.0	12.0	Q1
LM2904DRG4	SOIC	D	8	2500	330.0	12.4	6.4	5.2	2.1	8.0	12.0	Q1
LM2904PSR	SO	PS	8	2000	330.0	16.4	8.35	6.6	2.4	12.0	16.0	Q1
LM2904PSR-JF	SO	PS	8	2000	330.0	16.4	8.35	6.6	2.4	12.0	16.0	Q1
LM2904PWR	TSSOP	PW	8	2000	330.0	12.4	7.0	3.6	1.6	8.0	12.0	Q1
LM2904PWR	TSSOP	PW	8	2000	330.0	12.4	7.0	3.6	1.6	8.0	12.0	Q1
LM2904PWR-JF	TSSOP	PW	8	2000	330.0	12.4	7.0	3.6	1.6	8.0	12.0	Q1
LM2904PWRG3	TSSOP	PW	8	2000	330.0	12.4	7.0	3.6	1.6	8.0	12.0	Q1
LM2904PWRG4	TSSOP	PW	8	2000	330.0	12.4	7.0	3.6	1.6	8.0	12.0	Q1
LM2904PWRG4-JF	TSSOP	PW	8	2000	330.0	12.4	7.0	3.6	1.6	8.0	12.0	Q1
LM2904QDR	SOIC	D	8	2500	330.0	12.4	6.4	5.2	2.1	8.0	12.0	Q1
LM2904VQDR	SOIC	D	8	2500	330.0	12.5	6.4	5.2	2.1	8.0	12.0	Q1
LM2904VQDRG4	SOIC	D	8	2500	330.0	12.4	6.4	5.2	2.1	8.0	12.0	Q1
LM2904VQPWR	TSSOP	PW	8	2000	330.0	12.4	7.0	3.6	1.6	8.0	12.0	Q1
LM2904VQPWR	TSSOP	PW	8	2000	330.0	12.4	7.0	3.6	1.6	8.0	12.0	Q1
LM2904VQPWRG4	TSSOP	PW	8	2000	330.0	12.4	7.0	3.6	1.6	8.0	12.0	Q1
LM2904VQPWRG4	TSSOP	PW	8	2000	330.0	12.4	7.0	3.6	1.6	8.0	12.0	Q1
LM358ADGKR	VSSOP	DGK	8	2500	330.0	12.4	5.3	3.4	1.4	8.0	12.0	Q1
LM358ADR	SOIC	D	8	2500	330.0	12.4	6.4	5.2	2.1	8.0	12.0	Q1
LM358ADR	SOIC	D	8	2500	330.0	12.4	6.4	5.2	2.1	8.0	12.0	Q1
LM358ADR	SOIC	D	8	2500	330.0	12.8	6.4	5.2	2.1	8.0	12.0	Q1

Device	Package Type	Package Drawing	Pins	SPQ	Reel Diameter (mm)	Reel Width W1 (mm)	A0 (mm)	B0 (mm)	K0 (mm)	P1 (mm)	W (mm)	Pin1 Quadrant
LM358ADRG4	SOIC	D	8	2500	330.0	12.4	6.4	5.2	2.1	8.0	12.0	Q1
LM358ADRG4	SOIC	D	8	2500	330.0	12.4	6.4	5.2	2.1	8.0	12.0	Q1
LM358APWR	TSSOP	PW	8	2000	330.0	12.4	7.0	3.6	1.6	8.0	12.0	Q1
LM358APWR	TSSOP	PW	8	2000	330.0	12.4	7.0	3.6	1.6	8.0	12.0	Q1
LM358APWRG4	TSSOP	PW	8	2000	330.0	12.4	7.0	3.6	1.6	8.0	12.0	Q1
LM358BAIDDFR	SOT-23-THIN	DDF	8	3000	180.0	8.4	3.2	3.2	1.4	4.0	8.0	Q3
LM358BAIDGKR	VSSOP	DGK	8	2500	330.0	12.4	5.3	3.4	1.4	8.0	12.0	Q1
LM358BAIDR	SOIC	D	8	2500	330.0	12.4	6.4	5.2	2.1	8.0	12.0	Q1
LM358BAIPWR	TSSOP	PW	8	2000	330.0	12.4	7.0	3.6	1.6	8.0	12.0	Q1
LM358BIDDFR	SOT-23-THIN	DDF	8	3000	180.0	8.4	3.2	3.2	1.4	4.0	8.0	Q3
LM358BIDGKR	VSSOP	DGK	8	2500	330.0	12.4	5.3	3.4	1.4	8.0	12.0	Q1
LM358BIDR	SOIC	D	8	2500	330.0	12.4	6.4	5.2	2.1	8.0	12.0	Q1
LM358BIPWR	TSSOP	PW	8	2000	330.0	12.4	7.0	3.6	1.6	8.0	12.0	Q1
LM358DGKR	VSSOP	DGK	8	2500	330.0	12.4	5.3	3.4	1.4	8.0	12.0	Q1
LM358DGKR	VSSOP	DGK	8	2500	330.0	12.4	5.3	3.4	1.4	8.0	12.0	Q1
LM358DR	SOIC	D	8	2500	330.0	12.4	6.4	5.2	2.1	8.0	12.0	Q1
LM358DR	SOIC	D	8	2500	330.0	12.4	6.4	5.2	2.1	8.0	12.0	Q1
LM358DRG3	SOIC	D	8	2500	330.0	12.8	6.4	5.2	2.1	8.0	12.0	Q1
LM358DRG4	SOIC	D	8	2500	330.0	12.4	6.4	5.2	2.1	8.0	12.0	Q1
LM358DRG4	SOIC	D	8	2500	330.0	12.4	6.4	5.2	2.1	8.0	12.0	Q1
LM358PSR	SO	PS	8	2000	330.0	16.4	8.35	6.6	2.4	12.0	16.0	Q1
LM358PSR-JF	SO	PS	8	2000	330.0	16.4	8.35	6.6	2.4	12.0	16.0	Q1
LM358PWR	TSSOP	PW	8	2000	330.0	12.4	7.0	3.6	1.6	8.0	12.0	Q1
LM358PWR	TSSOP	PW	8	2000	330.0	12.4	7.0	3.6	1.6	8.0	12.0	Q1
LM358PWR-JF	TSSOP	PW	8	2000	330.0	12.4	7.0	3.6	1.6	8.0	12.0	Q1
LM358PWR-JF	TSSOP	PW	8	2000	330.0	12.4	7.0	3.6	1.6	8.0	12.0	Q1
LM358PWRG3	TSSOP	PW	8	2000	330.0	12.4	7.0	3.6	1.6	8.0	12.0	Q1
LM358PWRG4	TSSOP	PW	8	2000	330.0	12.4	7.0	3.6	1.6	8.0	12.0	Q1
LM358PWRG4-JF	TSSOP	PW	8	2000	330.0	12.4	7.0	3.6	1.6	8.0	12.0	Q1

TAPE AND REEL BOX DIMENSIONS

*All dimensions are nominal

Device	Package Type	Package Drawing	Pins	SPQ	Length (mm)	Width (mm)	Height (mm)
LM258ADGKR	VSSOP	DGK	8	2500	366.0	364.0	50.0
LM258ADR	SOIC	D	8	2500	364.0	364.0	27.0
LM258ADR	SOIC	D	8	2500	340.5	336.1	25.0
LM258ADR	SOIC	D	8	2500	340.5	338.1	20.6
LM258DGKR	VSSOP	DGK	8	2500	366.0	364.0	50.0
LM258DR	SOIC	D	8	2500	364.0	364.0	27.0
LM258DR	SOIC	D	8	2500	340.5	338.1	20.6
LM258DR	SOIC	D	8	2500	340.5	338.1	20.6
LM258DRG3	SOIC	D	8	2500	364.0	364.0	27.0
LM258DRG4	SOIC	D	8	2500	340.5	338.1	20.6
LM258DRG4	SOIC	D	8	2500	340.5	338.1	20.6
LM258DRG4	SOIC	D	8	2500	356.0	356.0	35.0
LM258DRG4	SOIC	D	8	2500	356.0	356.0	35.0
LM2904AVQDR	SOIC	D	8	2500	340.5	338.1	20.6
LM2904AVQDR	SOIC	D	8	2500	340.5	338.1	20.6
LM2904AVQDRG4	SOIC	D	8	2500	340.5	338.1	20.6
LM2904AVQDRG4	SOIC	D	8	2500	340.5	338.1	20.6
LM2904AVQPWR	TSSOP	PW	8	2000	356.0	356.0	35.0

Device	Package Type	Package Drawing	Pins	SPQ	Length (mm)	Width (mm)	Height (mm)
LM2904AVQPWR	TSSOP	PW	8	2000	356.0	356.0	35.0
LM2904AVQPWRG4	TSSOP	PW	8	2000	356.0	356.0	35.0
LM2904AVQPWRG4	TSSOP	PW	8	2000	356.0	356.0	35.0
LM2904BAIDDFR	SOT-23-THIN	DDF	8	3000	210.0	185.0	35.0
LM2904BAIDGKR	VSSOP	DGK	8	2500	366.0	364.0	50.0
LM2904BAIDR	SOIC	D	8	2500	340.5	338.1	20.6
LM2904BAIPWR	TSSOP	PW	8	2000	356.0	356.0	35.0
LM2904BIDDFR	SOT-23-THIN	DDF	8	3000	210.0	185.0	35.0
LM2904BIDGKR	VSSOP	DGK	8	2500	366.0	364.0	50.0
LM2904BIDR	SOIC	D	8	2500	340.5	338.1	20.6
LM2904BIPWR	TSSOP	PW	8	2000	356.0	356.0	35.0
LM2904DGKR	VSSOP	DGK	8	2500	358.0	335.0	35.0
LM2904DGKR	VSSOP	DGK	8	2500	366.0	364.0	50.0
LM2904DR	SOIC	D	8	2500	364.0	364.0	27.0
LM2904DR	SOIC	D	8	2500	340.5	338.1	20.6
LM2904DR	SOIC	D	8	2500	340.5	338.1	20.6
LM2904DRG3	SOIC	D	8	2500	364.0	364.0	27.0
LM2904DRG4	SOIC	D	8	2500	340.5	338.1	20.6
LM2904DRG4	SOIC	D	8	2500	340.5	338.1	20.6
LM2904PSR	SO	PS	8	2000	356.0	356.0	35.0
LM2904PSR-JF	SO	PS	8	2000	356.0	356.0	35.0
LM2904PWR	TSSOP	PW	8	2000	364.0	364.0	27.0
LM2904PWR	TSSOP	PW	8	2000	356.0	356.0	35.0
LM2904PWR-JF	TSSOP	PW	8	2000	356.0	356.0	35.0
LM2904PWRG3	TSSOP	PW	8	2000	364.0	364.0	27.0
LM2904PWRG4	TSSOP	PW	8	2000	356.0	356.0	35.0
LM2904PWRG4-JF	TSSOP	PW	8	2000	356.0	356.0	35.0
LM2904QDR	SOIC	D	8	2500	350.0	350.0	43.0
LM2904VQDR	SOIC	D	8	2500	340.5	338.1	20.6
LM2904VQDRG4	SOIC	D	8	2500	340.5	338.1	20.6
LM2904VQPWR	TSSOP	PW	8	2000	356.0	356.0	35.0
LM2904VQPWR	TSSOP	PW	8	2000	356.0	356.0	35.0
LM2904VQPWRG4	TSSOP	PW	8	2000	356.0	356.0	35.0
LM2904VQPWRG4	TSSOP	PW	8	2000	356.0	356.0	35.0
LM358ADGKR	VSSOP	DGK	8	2500	366.0	364.0	50.0
LM358ADR	SOIC	D	8	2500	340.5	338.1	20.6
LM358ADR	SOIC	D	8	2500	340.5	338.1	20.6
LM358ADR	SOIC	D	8	2500	364.0	364.0	27.0
LM358ADRG4	SOIC	D	8	2500	340.5	338.1	20.6
LM358ADRG4	SOIC	D	8	2500	340.5	338.1	20.6
LM358APWR	TSSOP	PW	8	2000	364.0	364.0	27.0
LM358APWR	TSSOP	PW	8	2000	356.0	356.0	35.0
LM358APWRG4	TSSOP	PW	8	2000	356.0	356.0	35.0

Device	Package Type	Package Drawing	Pins	SPQ	Length (mm)	Width (mm)	Height (mm)
LM358BAIDDFR	SOT-23-THIN	DDF	8	3000	210.0	185.0	35.0
LM358BAIDGKR	VSSOP	DGK	8	2500	366.0	364.0	50.0
LM358BAIDR	SOIC	D	8	2500	340.5	338.1	20.6
LM358BAIPWR	TSSOP	PW	8	2000	356.0	356.0	35.0
LM358BIDDFR	SOT-23-THIN	DDF	8	3000	210.0	185.0	35.0
LM358BIDGKR	VSSOP	DGK	8	2500	366.0	364.0	50.0
LM358BIDR	SOIC	D	8	2500	340.5	338.1	20.6
LM358BIPWR	TSSOP	PW	8	2000	356.0	356.0	35.0
LM358DGKR	VSSOP	DGK	8	2500	366.0	364.0	50.0
LM358DGKR	VSSOP	DGK	8	2500	358.0	335.0	35.0
LM358DR	SOIC	D	8	2500	340.5	338.1	20.6
LM358DR	SOIC	D	8	2500	340.5	338.1	20.6
LM358DRG3	SOIC	D	8	2500	364.0	364.0	27.0
LM358DRG4	SOIC	D	8	2500	340.5	336.1	25.0
LM358DRG4	SOIC	D	8	2500	340.5	338.1	20.6
LM358PSR	SO	PS	8	2000	356.0	356.0	35.0
LM358PSR-JF	SO	PS	8	2000	356.0	356.0	35.0
LM358PWR	TSSOP	PW	8	2000	356.0	356.0	35.0
LM358PWR	TSSOP	PW	8	2000	364.0	364.0	27.0
LM358PWR-JF	TSSOP	PW	8	2000	356.0	356.0	35.0
LM358PWR-JF	TSSOP	PW	8	2000	364.0	364.0	27.0
LM358PWRG3	TSSOP	PW	8	2000	364.0	364.0	27.0
LM358PWRG4	TSSOP	PW	8	2000	356.0	356.0	35.0
LM358PWRG4-JF	TSSOP	PW	8	2000	356.0	356.0	35.0

TUBE

*All dimensions are nominal

Device	Package Name	Package Type	Pins	SPQ	L (mm)	W (mm)	T (µm)	B (mm)
5962-87710012A	FK	LCCC	20	55	506.98	12.06	2030	NA
5962-87710022A	FK	LCCC	20	55	506.98	12.06	2030	NA
LM158AFKB	FK	LCCC	20	55	506.98	12.06	2030	NA
LM158FKB	FK	LCCC	20	55	506.98	12.06	2030	NA
LM258AP	P	PDIP	8	50	506.1	9	600	5.4
LM258AP	P	PDIP	8	50	506	13.97	11230	4.32
LM258APE4	P	PDIP	8	50	506	13.97	11230	4.32
LM258P	P	PDIP	8	50	506.1	9	600	5.4
LM258P	P	PDIP	8	50	506	13.97	11230	4.32
LM258PE4	P	PDIP	8	50	506	13.97	11230	4.32
LM2904P	P	PDIP	8	50	506.1	9	600	5.4
LM2904P	P	PDIP	8	50	506	13.97	11230	4.32
LM2904PE4	P	PDIP	8	50	506	13.97	11230	4.32
LM358AP	P	PDIP	8	50	506.1	9	600	5.4
LM358AP	P	PDIP	8	50	506	13.97	11230	4.32
LM358APE4	P	PDIP	8	50	506	13.97	11230	4.32
LM358APW	PW	TSSOP	8	150	530	10.2	3600	3.5
LM358P	P	PDIP	8	50	506.1	9	600	5.4
LM358P	P	PDIP	8	50	506	13.97	11230	4.32
LM358PE3	P	PDIP	8	50	506.1	9	600	5.4
LM358PE4	P	PDIP	8	50	506	13.97	11230	4.32
LM358PS-JF	PS	SOP	8	80	530	10.5	4000	4.1
LM358PW	PW	TSSOP	8	150	530	10.2	3600	3.5
LM358PW-JF	PW	TSSOP	8	150	530	10.2	3600	3.5

DDF0008A



PACKAGE OUTLINE

SOT-23 - 1.1 mm max height

PLASTIC SMALL OUTLINE



NOTES:

1. All linear dimensions are in millimeters. Any dimensions in parenthesis are for reference only. Dimensioning and tolerancing per ASME Y14.5M.
2. This drawing is subject to change without notice.
3. This dimension does not include mold flash, protrusions, or gate burrs. Mold flash, protrusions, or gate burrs shall not exceed 0.15 mm per side.

EXAMPLE BOARD LAYOUT

DDF0008A

SOT-23 - 1.1 mm max height

PLASTIC SMALL OUTLINE



LAND PATTERN EXAMPLE
SCALE:15X

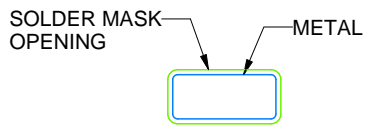

NON SOLDER MASK
DEFINED

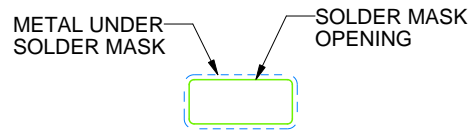

SOLDER MASK
DEFINED

SOLDER MASK DETAILS

4222047/C 10/2022

NOTES: (continued)

4. Publication IPC-7351 may have alternate designs.
5. Solder mask tolerances between and around signal pads can vary based on board fabrication site.

EXAMPLE STENCIL DESIGN

DDF0008A

SOT-23 - 1.1 mm max height

PLASTIC SMALL OUTLINE



SOLDER PASTE EXAMPLE
BASED ON 0.125 mm THICK STENCIL
SCALE:15X

4222047/C 10/2022

NOTES: (continued)

6. Laser cutting apertures with trapezoidal walls and rounded corners may offer better paste release. IPC-7525 may have alternate design recommendations.
7. Board assembly site may have different recommendations for stencil design.

GENERIC PACKAGE VIEW

FK 20

LCCC - 2.03 mm max height

8.89 x 8.89, 1.27 mm pitch

LEADLESS CERAMIC CHIP CARRIER

This image is a representation of the package family, actual package may vary.
Refer to the product data sheet for package details.



4229370VA\

D0008A



PACKAGE OUTLINE

SOIC - 1.75 mm max height

SMALL OUTLINE INTEGRATED CIRCUIT

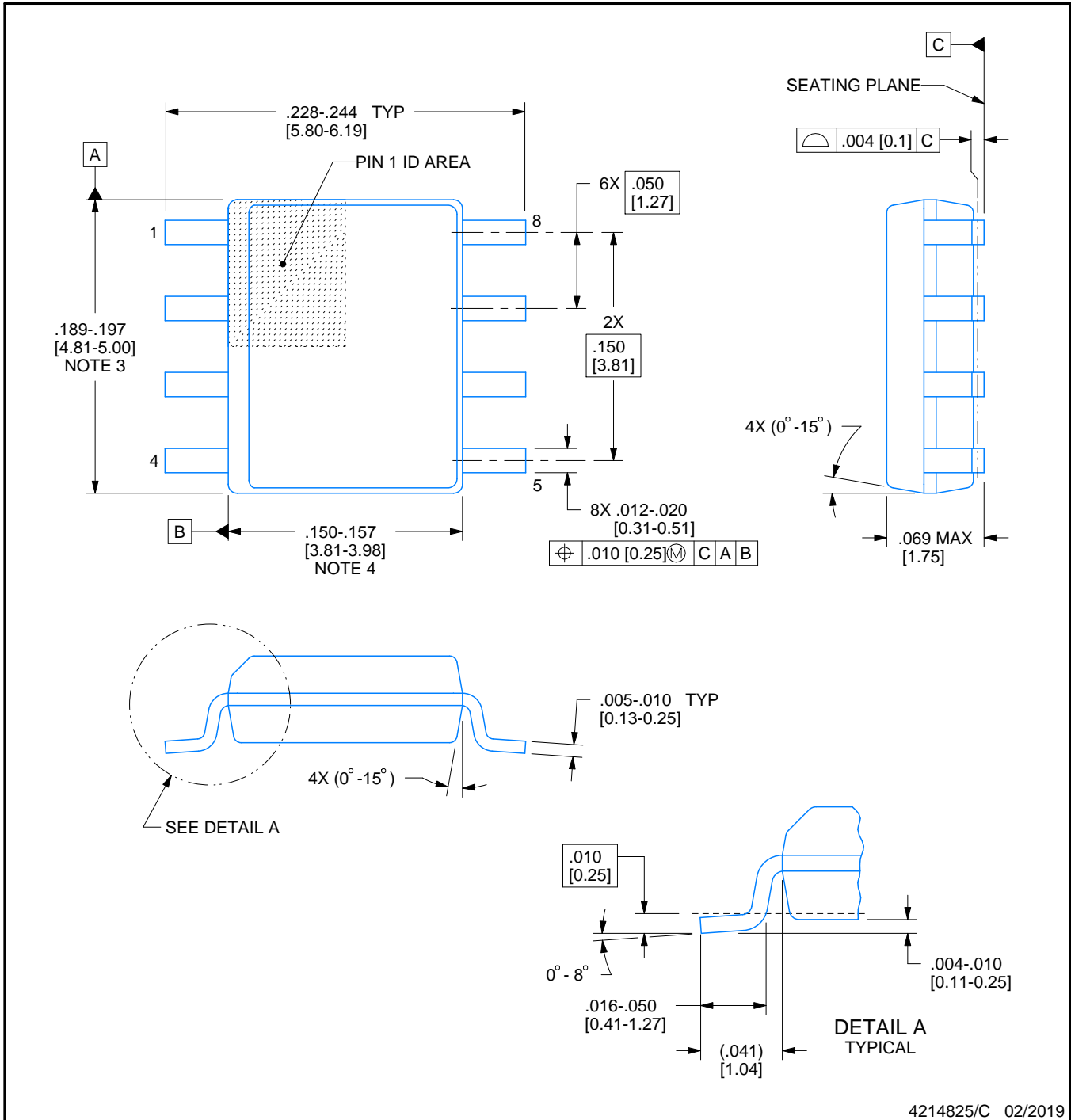

4214825/C 02/2019

NOTES:

1. Linear dimensions are in inches [millimeters]. Dimensions in parenthesis are for reference only. Controlling dimensions are in inches. Dimensioning and tolerancing per ASME Y14.5M.
2. This drawing is subject to change without notice.
3. This dimension does not include mold flash, protrusions, or gate burrs. Mold flash, protrusions, or gate burrs shall not exceed .006 [0.15] per side.
4. This dimension does not include interlead flash.
5. Reference JEDEC registration MS-012, variation AA.

EXAMPLE BOARD LAYOUT

D0008A

SOIC - 1.75 mm max height

SMALL OUTLINE INTEGRATED CIRCUIT



LAND PATTERN EXAMPLE
EXPOSED METAL SHOWN
SCALE:8X



SOLDER MASK DETAILS

4214825/C 02/2019

NOTES: (continued)

6. Publication IPC-7351 may have alternate designs.

7. Solder mask tolerances between and around signal pads can vary based on board fabrication site.

EXAMPLE STENCIL DESIGN

D0008A

SOIC - 1.75 mm max height

SMALL OUTLINE INTEGRATED CIRCUIT



SOLDER PASTE EXAMPLE
BASED ON .005 INCH [0.125 MM] THICK STENCIL
SCALE:8X

4214825/C 02/2019

NOTES: (continued)

8. Laser cutting apertures with trapezoidal walls and rounded corners may offer better paste release. IPC-7525 may have alternate design recommendations.
9. Board assembly site may have different recommendations for stencil design.

MECHANICAL DATA

PS (R-PDSO-G8)

PLASTIC SMALL-OUTLINE PACKAGE



- NOTES:
- A. All linear dimensions are in millimeters.
 - B. This drawing is subject to change without notice.
 - C. Body dimensions do not include mold flash or protrusion, not to exceed 0,15.

PS (R-PDSO-G8)

PLASTIC SMALL OUTLINE



- NOTES:
- A. All linear dimensions are in millimeters.
 - B. This drawing is subject to change without notice.
 - C. Publication IPC-7351 is recommended for alternate designs.
 - D. Laser cutting apertures with trapezoidal walls and also rounding corners will offer better paste release. Customers should contact their board assembly site for stencil design recommendations. Refer to IPC-7525 for other stencil recommendations.
 - E. Customers should contact their board fabrication site for solder mask tolerances between and around signal pads.

JG (R-GDIP-T8)

CERAMIC DUAL-IN-LINE



- NOTES: A. All linear dimensions are in inches (millimeters).
 B. This drawing is subject to change without notice.
 C. This package can be hermetically sealed with a ceramic lid using glass frit.
 D. Index point is provided on cap for terminal identification.
 E. Falls within MIL STD 1835 GDIP1-T8

P (R-PDIP-T8)

PLASTIC DUAL-IN-LINE PACKAGE



- NOTES:
- A. All linear dimensions are in inches (millimeters).
 - B. This drawing is subject to change without notice.
 - C. Falls within JEDEC MS-001 variation BA.

DGK (S-PDSO-G8)

PLASTIC SMALL-OUTLINE PACKAGE



- NOTES:
- A. All linear dimensions are in millimeters.
 - B. This drawing is subject to change without notice.
 - C. Body length does not include mold flash, protrusions, or gate burrs. Mold flash, protrusions, or gate burrs shall not exceed 0.15 per end.
 - D. Body width does not include interlead flash. Interlead flash shall not exceed 0.50 per side.
 - E. Falls within JEDEC MO-187 variation AA, except interlead flash.



- NOTES:
- A. All linear dimensions are in millimeters.
 - B. This drawing is subject to change without notice.
 - C. Publication IPC-7351 is recommended for alternate designs.
 - D. Laser cutting apertures with trapezoidal walls and also rounding corners will offer better paste release. Customers should contact their board assembly site for stencil design recommendations. Refer to IPC-7525 for other stencil recommendations.
 - E. Customers should contact their board fabrication site for solder mask tolerances between and around signal pads.

PW0008A



PACKAGE OUTLINE

TSSOP - 1.2 mm max height

SMALL OUTLINE PACKAGE



4221848/A 02/2015

NOTES:

1. All linear dimensions are in millimeters. Any dimensions in parenthesis are for reference only. Dimensioning and tolerancing per ASME Y14.5M.
2. This drawing is subject to change without notice.
3. This dimension does not include mold flash, protrusions, or gate burrs. Mold flash, protrusions, or gate burrs shall not exceed 0.15 mm per side.
4. This dimension does not include interlead flash. Interlead flash shall not exceed 0.25 mm per side.
5. Reference JEDEC registration MO-153, variation AA.

EXAMPLE BOARD LAYOUT

PW0008A

TSSOP - 1.2 mm max height

SMALL OUTLINE PACKAGE



LAND PATTERN EXAMPLE
SCALE:10X



SOLDER MASK DETAILS
NOT TO SCALE

4221848/A 02/2015

NOTES: (continued)

- 6. Publication IPC-7351 may have alternate designs.
- 7. Solder mask tolerances between and around signal pads can vary based on board fabrication site.

EXAMPLE STENCIL DESIGN

PW0008A

TSSOP - 1.2 mm max height

SMALL OUTLINE PACKAGE



SOLDER PASTE EXAMPLE
BASED ON 0.125 mm THICK STENCIL
SCALE:10X

4221848/A 02/2015

NOTES: (continued)

8. Laser cutting apertures with trapezoidal walls and rounded corners may offer better paste release. IPC-7525 may have alternate design recommendations.
9. Board assembly site may have different recommendations for stencil design.

重要声明和免责声明

TI“按原样”提供技术和可靠性数据（包括数据表）、设计资源（包括参考设计）、应用或其他设计建议、网络工具、安全信息和其他资源，不保证没有瑕疵且不做任何明示或暗示的担保，包括但不限于对适销性、某特定用途方面的适用性或不侵犯任何第三方知识产权的暗示担保。

这些资源可供使用 TI 产品进行设计的熟练开发人员使用。您将自行承担以下全部责任：(1) 针对您的应用选择合适的 TI 产品，(2) 设计、验证并测试您的应用，(3) 确保您的应用满足相应标准以及任何其他功能安全、信息安全、监管或其他要求。

这些资源如有变更，恕不另行通知。TI 授权您仅可将这些资源用于研发本资源所述的 TI 产品的应用。严禁对这些资源进行其他复制或展示。您无权使用任何其他 TI 知识产权或任何第三方知识产权。您应全额赔偿因在这些资源的使用中对 TI 及其代表造成的任何索赔、损害、成本、损失和债务，TI 对此概不负责。

TI 提供的产品受 [TI 的销售条款](#) 或 [ti.com](#) 上其他适用条款/TI 产品随附的其他适用条款的约束。TI 提供这些资源并不会扩展或以其他方式更改 TI 针对 TI 产品发布的适用的担保或担保免责声明。

TI 反对并拒绝您可能提出的任何其他或不同的条款。

邮寄地址：Texas Instruments, Post Office Box 655303, Dallas, Texas 75265

Copyright © 2023，德州仪器 (TI) 公司

单击下面可查看定价，库存，交付和生命周期等信息

[>>TI\(德州仪器\)](#)