

TPS23882B 带自主模式、SRAM 和 200mΩ RSENSE 的 3 类、2 线对 8 通道 PSE 控制器

1 特性

- 适用于 PoE 2 3 类 2 线对以太网供电应用的 IEEE 802.3bt PSE 解决方案
- 与 TI 的 *FirmPSE* 系统固件兼容
- **SRAM 可编程存储器**
- 可编程功率限制精度 $\pm 4\%$
- 200 mΩ 电流感测电阻
- 用户可选择 15W 或 30W 自主模式，无需 MCU
- 可选的 2 线对端口功率分配
 - 4W、7W、15.4W 或 30W
- 各端口专用的 14 位积分电流 ADC
 - 用于直流断开的抗噪 MPS
 - 2% 电流感测精度
- 1 位或 3 位快速端口关断输入
- **Auto-class** 发现和功率测量
- **可靠的 4 点检测**
- 浪涌和操作折返保护
- 425mA 和 1.25A 可选电流限值
- 端口重映射
- 8 位或 16 位 I²C 通信
- 灵活的处理控制运行模式
 - 自动、半自动和手动/诊断
- 各端口电压监控和遥测
- -40 °C 至 +125 °C 工作温度

2 应用

- 录像机 (NVR、DVR 等)
- 小型企业交换机
- 园区交换机和分支交换机

3 说明

TPS23882B 是一款 8 通道电源设备 (PSE) 控制器，旨在按照 IEEE 802.3bt 标准向以太网电缆提供电力。PSE 控制器可以检测具有有效签名、完全相互识别和接通电源的供电设备 (PD)。

TPS23882B 在 TPS2388 的基础上进行了改进，减小了电流感测电阻，提供了 SRAM 可编程性、可编程功率限制、电容测量以及与 TI *FirmPSE* 系统固件的兼容性 (请参阅 [器件比较表](#))。

可编程 SRAM 支持通过 I²C 实现现场固件可升级性，从而确保 IEEE 合规性以及与支持新 PoE 器件的互操作性。各端口专用 ADC 可提供持续的端口电流监控和执行并行分级测量的功能，以实现更快的端口开启速度。1.25A 端口电流限制和可调节功率限制可支持 60W 以上的非标准应用。200mΩ 电流感测电阻器和

外部 FET 架构使设计能够平衡尺寸、效率、散热和解决方案成本要求。

端口重映射以及 与 TPS2388、TPS23880 和 TPS23881 的引脚对引脚兼容性可轻松实现上一代 PSE 设计的迁移，并支持可互换 2 层 PCB 设计以适应不同系统 PoE 电源配置。

器件信息(1)

器件型号	封装	封装尺寸 (标称值)
TPS23882B	VQFN (56)	8.00mm x 8.00mm

- (1) 如需了解所有可用封装，请参阅数据表末尾的可订购产品附录。

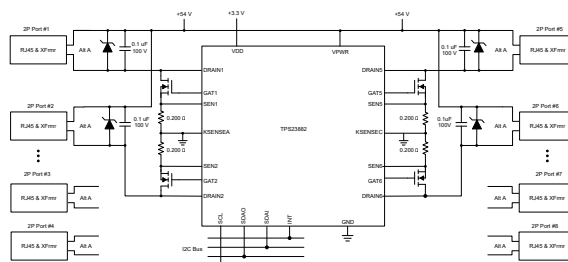

简化版原理图



Table of Contents

1 特性	1	9.5 I ² C Programming.....	30
2 应用	1	9.6 Register Maps.....	33
3 说明	1	10 Application and Implementation	107
4 Revision History	2	10.1 Application Information.....	107
5 Device Comparison Table	3	10.2 Typical Application.....	109
6 Pin Configuration and Functions	4	11 Power Supply Recommendations	114
6.1 Detailed Pin Description.....	5	11.1 VDD.....	114
7 Specifications	7	11.2 VPWR.....	114
7.1 Absolute Maximum Ratings.....	7	12 Layout	115
7.2 ESD Ratings.....	7	12.1 Layout Guidelines.....	115
7.3 Recommended Operating Conditions.....	7	12.2 Layout Example.....	116
7.4 Thermal Information.....	7	13 Device and Documentation Support	117
7.5 Electrical Characteristics.....	8	13.1 Documentation Support.....	117
7.6 Typical Characteristics.....	14	13.2 接收文档更新通知.....	117
8 Parameter Measurement Information	19	13.3 支持资源.....	117
8.1 Timing Diagrams.....	19	13.4 Trademarks.....	117
9 Detailed Description	21	13.5 Electrostatic Discharge Caution.....	117
9.1 Overview.....	21	13.6 术语表.....	117
9.2 Functional Block Diagram.....	26	14 Mechanical, Packaging, and Orderable Information	117
9.3 Feature Description.....	27		
9.4 Device Functional Modes.....	29		

4 Revision History

注：以前版本的页码可能与当前版本的页码不同

Changes from Revision * (April 2021) to Revision A (February 2022)	Page
• 将提到 I ² C 的旧术语实例通篇更改为控制器和目标.....	1
• Corrected the ESD Ratings charged device model row to show testing was per JS-002.....	7
• Updated the Functional Block Diagram	26
• Changed the reset state value for register 0x43.....	33
• Updated 图 12-2	115

5 Device Comparison Table

表 5-1 summarizes the primary differences between the available 2-pair PSE devices.

KEY FEATURES	TPS23880	TPS23881	TPS23882B
Compatible with TI's <i>FirmPSE</i> system firmware	N/A	Yes	Yes
Pin-to-pin compatible	Yes	Yes	Yes
Number of PSE channels	8	8	8
Supported IEEE 802.3 PSE Types	PoE 2 802.3bt Type 3 or 4 (2 or 4 pair)	PoE 2 802.3bt Type 3 or 4 (2 or 4 pair)	PoE 2 802.3bt Type 3 (2 pair)
R _{SENSE}	0.255 Ω	0.200 Ω	0.200 Ω
2-pair P _{CUT} programmable ranges	0.5 W to 54 W	2 W to 65 W	2 W to 65 W
4-pair P _{CUT} programmable ranges	0.5 W to 108 W	4 W to 127 W	N/A
90+ W 4-pair P _{CUT} accuracy	±3.0 %	±2.5 %	N/A
Channel capacitance measurement range	N/A	1 μF to 12 μF	1 μF to 12 μF
ULA packaging	No	Yes (TPS23881A)	N/A
I ² C programmable SRAM memory	16 kB	16 kB	16 kB

表 5-1. 2-Pair PSE Key Feature Comparisons

KEY FEATURES	TPS23861	TPS2388	TPS23881	TPS23882B
Compatible with TI's <i>FirmPSE</i> system firmware	N/A	N/A	Yes	Yes
Pin-to-pin compatible	N/A	Yes	Yes	Yes
Number of PSE channels	4	8	8	8
Supported IEEE 802.3 PSE Types	PoE 1 802.3 at Type 1 or 2	PoE 1 802.3 at Type 1 or 2	PoE 2 802.3bt Type 3 or 4 (2 or 4 pair)	PoE 2 802.3bt Type 3 (2 pair)
R _{SENSE}	0.255 Ω	0.255 Ω	0.200 Ω	0.200 Ω
2-pair P _{CUT} programmable ranges	N/A I _{CUT} adjustable up to 920 mA	N/A I _{CUT} adjustable up to 920 mA	2 W to 65 W	2 W to 65 W
T _{MPS}	15 ms	15 ms	3 ms	3 ms
Port current limit (1x / 2x)	425 mA / 1060 mA	425 mA / 1060 mA	425 mA / 1250 mA	425 mA / 1250 mA
Channel capacitance measurement range	N/A	N/A	1 μF to 12 μF	1 μF to 12 μF
PD auto-class discovery and power measurement	N/A	N/A	Yes	Yes
I ² C programmable SRAM memory	N/A	N/A	16 kB	16 kB

6 Pin Configuration and Functions



图 6-1. RTQ Package with Exposed Thermal Pad 56-Pin VQFN Top View

表 6-1. Pin Functions

PIN		I/O	DESCRIPTION
NAME	NO.		
A1-4	48 - 51	I	I ² C A1-A4 address lines. These pins are internally pulled up to VDD.
AGND	21	—	Analog ground. Connect to GND plane and exposed thermal pad.
DGND	46	—	Digital ground. Connect to GND plane and exposed thermal pad.
DRAIN1-8	3, 5, 10, 12, 31, 33, 38, 40	I	Channel 1-8 output voltage monitor
GAT1-8	1, 7, 8, 14, 29, 35, 36, 42	O	Channel 1-8 gate drive output
INT	45	O	Interrupt output. This pin asserts low when a bit in the interrupt register is asserted. This output is open-drain.
KSENSA/B	4, 11	I	Kelvin point connection for SEN1-4
KSENSC/D	32, 39	I	Kelvin point connection for SEN5-8

表 6-1. Pin Functions (continued)

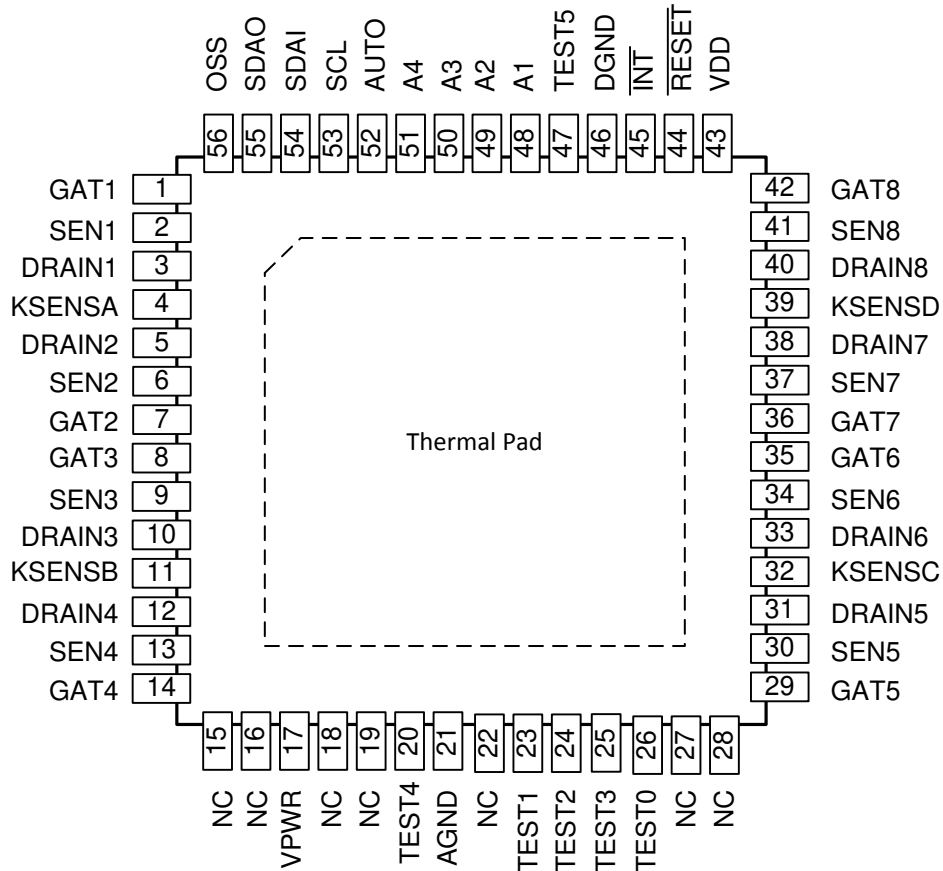
PIN		I/O	DESCRIPTION
NAME	NO.		
NC	15, 16, 18, 19	O	No connect pins. These pins are internally biased at 1/3 and 2/3 of VPWR in order to control the voltage gradient from VPWR. Leave open.
	22, 27, 28	—	No connect pin. Leave open.
OSS	56	I	Channel 1-8 fast shutdown. This pin is internally pulled down to DGND.
RESET	44	I	Reset input. When asserted low, the TPS23882B is reset. This pin is internally pulled up to VDD.
SCL	53	I	Serial clock input for I ² C bus.
SDAI	54	I	Serial data input for I ² C bus. This pin can be connected to SDAO for non-isolated systems.
SDAO	55	O	Serial data output for I ² C bus. This pin can be connected to SDAI for non-isolated systems. This output is open-drain.
AUTO	52	I/O	Autonomous mode enable and selection pin
SEN1-8	2, 6, 9, 13, 30, 34, 37, 41	I	Channel 1-8 current sense input
TEST0-5	20, 23, 24, 25, 26, 47	I/O	Used internally for test purposes only. Leave open.
Thermal pad	—	—	The DGND and AGND terminals must be connected to the exposed thermal pad for proper operation.
VDD	43	—	Digital supply. Bypass with 0.1 μ F to DGND pin.
VPWR	17	—	Analog 54-V positive supply. Bypass with 0.1 μ F to AGND pin.

6.1 Detailed Pin Description

The following descriptions refer to the pinout and the functional block diagram.

DRAIN1-DRAIN8: Channels 1-8 output voltage monitor and detect sense. Used to measure the port output voltage, for port voltage monitoring, port power good detection and foldback action. Detection probe currents also flow into this pin.

The TPS23882B uses an innovative 4-point technique to provide reliable PD detection and avoids powering an invalid load. The discovery is performed by sinking two different current levels via the DRAINn pin, while the PD voltage is measured from VPWR to DRAINn. If prior to starting a new detection cycle the port voltage is > 2.5 V, an internal 100-k Ω resistor is connected in parallel with the port and a 400-ms detect backoff period is applied to allow the port capacitor to be discharged before the detection cycle starts.

There is an internal resistor between each DRAINn pin and VPWR in any operating mode except during detection or while the port is ON. If the port n is not used, DRAINn can be left floating or tied to GND.

GAT1-GAT8: Channels 1-8 gate drive outputs are used for external N-channel MOSFET gate control. At port turn-on, the gate drive outputs are driven positive by a low current source to turn the MOSFET on. GATn is pulled low whenever any of the input supplies are low or if an overcurrent timeout has occurred. GATn is also pulled low if the port is turned off by use of manual shutdown inputs. Leave floating if unused.

For improved design robustness, the current foldback functions limit the power dissipation of the MOSFET during low resistance load or short-circuit events and during the inrush period at port turn on. There is also fast overload protection comparator for major faults like a direct short that forces the MOSFET to turn off in less than a microsecond.

The circuit leakage paths between the GATn pin and any nearby DRAINn pin, GND or Kelvin point connection must be minimized (< 250 nA), to ensure correct MOSFET control.

INT: This interrupt output pin asserts low when a bit in the interrupt register is asserted. This output is open-drain.

KSENSA, KSENSB, KSENSC, KSENSD: Kelvin point connection used to perform a differential voltage measurement across the associated current sense resistors.

Each KSENS is shared between two neighbor SEN pins as following: KSENSA with SEN1 and SEN2, KSENSB with SEN3 and SEN4, KSENSC with SEN5 and SEN6, KSENSD with SEN7 and SEN8. To optimize the measurement accuracy, ensure proper PCB layout practices are followed.

OSS: Fast shutdown, active high. This pin is internally pulled down to DGND, with an internal 1- μ s to 5- μ s deglitch filter.

The turn-off procedure is similar to a port reset using reset command (1Ah register). The 3-bit OSS function allows for a series of pulses on the OSS pin to turn off individual or multiple ports with up to eight levels of priority.

RESET: Reset input, active low. When asserted, the TPS23882B resets, turning off all ports and forcing the registers to their power-up state. This pin is internally pulled up to VDD, with internal 1- μ s to 5- μ s deglitch filter. The designer can use an external RC network to delay the turn-on. There is also an internal power-on-reset which is independent of the RESET input.

SCL: Serial clock input for I²C bus.

SDAI: Serial data input for I²C bus. This pin can be connected to SDAO for non-isolated systems.

SDAO: Open-drain I²C bus output data line. Requires an external resistive pullup. The TPS23882B uses separate SDAO and SDAI lines to allow optoisolated I²C interface. SDAO can be connected to SDAI for non-isolated systems.

AUTO: *Autonomous* mode selection pin: Floating this pin disables autonomous operation. Tying this pin to GND through a resistor (R_{AUTO}) enables autonomous operation at selectable port power allocation levels. A 10-nF capacitor is required between the AUTO pin and GND if R_{AUTO} is connected.

A4-A1: I²C bus address inputs. These pins are internally pulled up to VDD. See [§ 9.6.2.13](#) for more details.

SEN1-8: Channel current sense input relative to KSENSn (see KSENSn description). A differential measurement is performed using KSENSA-D Kelvin point connection. Monitors the external MOSFET current by use of a 0.200- Ω current sense resistor connected to GND. Used by current foldback engine and also during classification. Can be used to perform load current monitoring via ADC conversion.

When the TPS23882B performs the classification measurements, the current flows through the external MOSFETs. This flow avoids heat concentration in the device and makes it possible for the TPS23882B to perform classification measurements on multiple ports at the same time. For the current limit with foldback function, there is an internal 2- μ S analog filter on the SEN1-8 pins to provide glitch filtering. For measurements through an ADC, an anti-aliasing filter is present on the SEN1-8 pins. This includes the port-powered current monitoring, port policing, and DC disconnect.

If the port is not used, tie SENn to GND.

VDD: 3.3-V logic power supply input.

VPWR: High voltage power supply input. Nominally 54 V.

AGND and DGND: Ground references for internal analog and digital circuitry respectively. Not connected together internally. Both pins require a low resistance path to the system GND plane. If a robust GND plane is used to extract heat from the device's thermal pad, these pins can be connected together through the thermal pad connection on the pcb.

7 Specifications

7.1 Absolute Maximum Ratings

over operating free-air temperature range (unless otherwise noted)⁽¹⁾

		MIN	MAX	UNIT
Voltage	VPWR	- 0.3	70	V
	VDD	- 0.3	4	V
	OSS, RESET, A1-A4	- 0.3	4	V
	SDAI, SDAO, SCL, INT	- 0.3	4	V
	SEN1-8, KSENSA, KSENSB, KSENSC, KSENSD	- 0.3	3	V
	GATE1-8	- 0.3	13	V
	DRAIN1-8	- 0.3	70	V
	AGND-GDND	- 0.3	0.3	V
Sink Current	INT, SDA		20	mA
Lead Temperature 1/6mm from case for 10 seconds			260	°C
T _{stg}	Storage temperature	- 65	150	°C

- (1) Stresses beyond those listed under *Absolute Maximum Rating* may cause permanent damage to the device. These are stress ratings only, which do not imply functional operation of the device at these or any other conditions beyond those indicated under *Recommended Operating Condition*. Exposure to absolute-maximum-rated conditions for extended periods may affect device reliability.

7.2 ESD Ratings

		VALUE	UNIT
V _(ESD)	Electrostatic discharge	Human body model (HBM), per ANSI/ESDA/JEDEC JS-001, all pins ⁽¹⁾	±2000
		Charged device model (CDM), per ANSI/ESDA/JEDEC JS-002, all pins ⁽²⁾	± 500

- (1) JEDEC document JEP155 states that 500-V HBM allows safe manufacturing with a standard ESD control process.
(2) JEDEC document JEP157 states that 250-V CDM allows safe manufacturing with a standard ESD control process.

7.3 Recommended Operating Conditions

over operating free-air temperature range (unless otherwise noted)

		MIN	NOM	MAX	UNIT
V _{VDD}		3	3.3	3.6	V
V _{VPWR}		44	54	57	V
	Voltage slew rate on VPWR			1	V/μs
f _{SCL}	I ² C clock frequency			400	kHz
T _J	Junction temperature	- 40		125	°C

7.4 Thermal Information

THERMAL METRIC ⁽¹⁾		TPS23882B		UNIT
		RTQ Package (VQFN)		
		56 PINS		
R _{θJA}	Junction-to-ambient thermal resistance	25.3		°C/W
R _{θJC(top)}	Junction-to-case (top) thermal resistance	9.7		°C/W
R _{θJB}	Junction-to-board thermal resistance	3.7		°C/W
Ψ _{JT}	Junction-to-top characterization parameter	0.2		°C/W
Ψ _{JB}	Junction-to-board characterization parameter	3.7		°C/W
R _{θJC(bot)}	Junction-to-case (bottom) thermal resistance	0.5		°C/W

- (1) For more information about traditional and new thermal metrics, see the [Semiconductor and IC Package Thermal Metrics](#) application report.

7.5 Electrical Characteristics

Conditions are $-40 < T_J < 125$ °C unless otherwise noted. $V_{VDD} = 3.3$ V, $V_{VPWR} = 54$ V, $V_{DGND} = V_{AGND}$. DGND, KSENSA, KSENSB, KSENSC and KSENSD connected to AGND, and all outputs are unloaded, $2x\text{FBn} = 0$. Positive currents are into pins. $R_S = 0.200$ Ω , to KSENSA (SEN1 or SEN2), to KSENSB (SEN3 or SEN4), to KSENSC (SEN5 or SEN6) or to KSENSD (SEN7 or SEN8). Typical values are at 25 °C. All voltages are with respect to AGND unless otherwise noted. Operating registers loaded with default values unless otherwise noted.

PARAMETER		TEST CONDITIONS	MIN	TYP	MAX	UNIT
INPUT SUPPLY VPWR						
I_{VPWR}	VPWR Current consumption	VVPWR = 54 V		10	12.5	mA
V_{UVLOPW_F}	VPWR UVLO falling threshold	Check internal oscillator stops operating	14.5		17.5	V
V_{UVLOPW_R}	VPWR UVLO rising threshold		15.5		18.5	V
V_{PUV_F}	VPWR Undervoltage falling threshold	VPUV threshold	25	26.5	28	V
INPUT SUPPLY VDD						
I_{VDD}	VDD Current consumption			6	12	mA
V_{UVDD_F}	VDD UVLO falling threshold	For channel deassertion	2.1	2.25	2.4	V
V_{UVDD_R}	VDD UVLO rising threshold		2.45	2.6	2.75	V
V_{UVDD_HYS}	Hysteresis VDD UVLO			0.35		V
V_{UVW_F}	VDD UVLO warning threshold	VDD falling	2.6	2.8	3	V
A/D CONVERTERS						
T_{CONV_I}	Conversion time	All ranges, each channel	0.64	0.8	0.96	ms
T_{CONV_V}	Conversion time	All ranges, each channel	0.82	1.03	1.2	ms
T_{INT_CUR}	Integration time, Current	Each channel, channel ON current	82	102	122	ms
T_{INT_DET}	Integration time, Detection		13.1	16.6	20	ms
$T_{INT_channelV}$	Integration time, Channel Voltage	channel powered	3.25	4.12	4.9	ms
T_{INT_inv}	Integration time, Input Voltage		3.25	4.12	4.9	ms
	Input voltage conversion scale factor and accuracy	VVPWR = 57 V	15175	15565	15955	Counts
			55.57	57	58.43	V
		VVPWR = 44 V	11713	12015	12316	Counts
			42.89	44	45.10	V
	Powered Channel voltage conversion scale factor and accuracy	VVPWR - VDRAINn = 57 V	15175	15565	15955	Counts
			55.57	57	58.43	V
		VVPWR - VDRAINn = 44 V	11713	12015	12316	Counts
			42.89	44	45.10	V
$\delta V/V_{\text{Channel}}$	Voltage reading accuracy		- 2.5		2.5	%
	Powered Channel current conversion scale factor and accuracy	Channel current = 770 mA	8431	8604	8776	Counts
			754.5	770	785.4	mA
		Channel Current = 100 mA	1084	1118	1152	Counts
			97	100	103	mA
$\delta I/I_{\text{Channel}}$	Current reading accuracy	Channel Current = 100 mA	- 3		3	%
		Channel Current = 770 mA	- 2		2	
$\delta R/R_{\text{Channel}}$	Resistance reading accuracy	$15 \text{ k}\Omega \leq R_{\text{Channel}} \leq 33 \text{ k}\Omega$, $C_{\text{Channel}} \leq 0.25 \mu\text{F}$	- 7		7	%
I_{bias}	Sense Pin bias current	Channel ON or during class	- 2.5		0	μA

7.5 Electrical Characteristics (continued)

Conditions are $-40 < T_J < 125$ °C unless otherwise noted. $V_{VDD} = 3.3$ V, $V_{VPWR} = 54$ V, $V_{DGND} = V_{AGND}$, DGND, KSENSA, KSENSB, KSENSC and KSENSD connected to AGND, and all outputs are unloaded, $2x\text{FBn} = 0$. Positive currents are into pins. $R_S = 0.200$ Ω , to KSENSA (SEN1 or SEN2), to KSENSB (SEN3 or SEN4), to KSENSC (SEN5 or SEN6) or to KSENSD (SEN7 or SEN8). Typical values are at 25 °C. All voltages are with respect to AGND unless otherwise noted. Operating registers loaded with default values unless otherwise noted.

PARAMETER		TEST CONDITIONS	MIN	TYP	MAX	UNIT
GATE 1-8						
V_{GOH}	Gate drive voltage	V_{GATEn} , $I_{GATE} = -1$ μ A	10		12.5	V
I_{GO-}	Gate sinking current with Power-on Reset, OSS detected or channel turnoff command	$V_{GATEn} = 5$ V	60	100	190	mA
$I_{GO\ short-}$	Gate sinking current with channel short-circuit	$V_{GATEn} = 5$ V, $V_{SENn} \geq V_{short}$ (or $V_{short2X}$ if 2X mode)	60	100	190	mA
I_{GO+}	Gate sourcing current	$V_{GATEn} = 0$ V, default selection	39	50	63	μ A
$t_{D_off_OSS}$	Gate turnoff time from 1-bit OSS input	From OSS to $V_{GATEn} < 1$ V, $V_{SENn} = 0$ V, $MbitPrty = 0$	1		5	μ s
t_{OSS_OFF}	Gate turnoff time from 3-bit OSS input	From Start bit falling edge to $V_{GATEn} < 1$ V, $V_{SENn} = 0$ V, $MbitPrty = 1$	72		104	μ s
$t_{P_off_CMD}$	Gate turnoff time from channel turnoff command	From Channel off command ($POFFn = 1$) to $V_{GATEn} < 1$ V, $V_{SENn} = 0$ V			300	μ s
$t_{P_off_RST}$	Gate turnoff time with /RESET	From /RESET low to $V_{GATEn} < 1$ V, $V_{SENn} = 0$ V	1		5	μ s
DRAIN 1-8						
V_{PGT}	Power-Good threshold	Measured at V_{DRAINn}	1	2.13	3	V
V_{SHT}	Shorted FET threshold	Measured at V_{DRAINn}	4	6	8	V
R_{DRAIN}	Resistance from DRAINn to VPWR	Any operating mode except during detection or while the Channel is ON, including in device RESET state	80	100	190	k Ω
AUTOCLASS						
t_{Class_ACS}	Start of Autoclass Detection	Measured from the start of Class	90		100	ms
t_{AUTO_PSE1}	Start of Autoclass Power Measurement	Measured from the end of Inrush	1.4		1.6	s
		Measured from setting the MACx bit while channel is already powered			10	ms
t_{AUTO}	Duration of Autoclass Power Measurement		1.7	1.8	1.9	s
t_{AUTO_window}	Autoclass Power Measurement Sliding Window		0.15		0.3	s
P_{AC}	Autoclass Channel Power conversion scale factor and accuracy	$VPWR = 52$ V, $VDRAINn = 0$ V, Channel current = 770 mA	76	80	84	Counts
		$VPWR = 50$ V, $VDRAINn = 0$ V, Channel current = 100 mA	9	10	11	

7.5 Electrical Characteristics (continued)

Conditions are $-40 < T_J < 125$ °C unless otherwise noted. $V_{VDD} = 3.3$ V, $V_{VPWR} = 54$ V, $V_{DGND} = V_{AGND}$, DGND, KSENSA, KSENSB, KSENSC and KSENSD connected to AGND, and all outputs are unloaded, $2x\text{FBn} = 0$. Positive currents are into pins. $R_S = 0.200$ Ω , to KSENSA (SEN1 or SEN2), to KSENSB (SEN3 or SEN4), to KSENSC (SEN5 or SEN6) or to KSENSD (SEN7 or SEN8). Typical values are at 25 °C. All voltages are with respect to AGND unless otherwise noted. Operating registers loaded with default values unless otherwise noted.

PARAMETER		TEST CONDITIONS	MIN	TYP	MAX	UNIT
DETECTION						
I_{DISC}	Detection current	First and 3rd detection points VVPWR - VDRAINn = 0 V	145	160	190	μA
		2nd and 4th detection points VVPWR - VDRAINn = 0 V	235	270	300	
ΔI_{DISC}	2nd - 1st detection currents	VVPWR - VDRAINn = 0 V	98	110	118	μA
$V_{\text{det_open}}$	Open circuit detection voltage	Measured as VVPWR - VDRAINn	23.5	26	29	V
$R_{\text{REJ_LOW}}$	Rejected resistance low range		0.86		15	k Ω
$R_{\text{REJ_HI}}$	Rejected resistance high range		33		100	k Ω
R_{ACCEPT}	Accepted resistance range		19	25	26.5	k Ω
R_{SHORT}	Shorted Channel threshold				360	Ω
R_{OPEN}	Open Channel Threshold		400			k Ω
t_{DET}	Detection Duration	Time to complete a detection	275	350	425	ms
$t_{\text{DET_BOFF}}$	Detect backoff pause between discovery attempts	VVPWR - VDRAINn > 2.5 V	300	400	500	ms
		VVPWR - VDRAINn < 2.5 V	20		100	ms
$t_{\text{DET_DLY}}$	Detection delay	From command or PD attachment to Channel detection complete			590	ms
	Capacitance Measurement	Cport = 10uF	8.5	10	11.5	μF
CLASSIFICATION						
V_{CLASS}	Classification Voltage	VVPWR - VDRAINn, VSEn \geq 0 mV $I_{\text{channel}} \geq 180$ μA	15.5	18.5	20.5	V
$I_{\text{CLASS_Lim}}$	Classification Current Limit	VVPWR - VDRAINn = 0 V	65	75	90	mA
$I_{\text{CLASS_TH}}$	Classification Threshold Current	Class 0-1	5		8	mA
		Class 1-2	13		16	mA
		Class 2-3	21		25	mA
		Class 3-4	31		35	mA
		Class 4-Class overcurrent	45		51	mA
t_{LCE}	Classification Duration (1st Finger)	From detection complete	95		105	ms
$t_{\text{CLE2/3}}$	Classification Duration (2nd & 3th Finger)	From Mark complete	6.5		12	ms
MARK						
V_{MARK}	Mark Voltage	4 mA $\geq I_{\text{channel}} \geq 180$ μA VVPWR - VDRAINn	7		10	V
$I_{\text{MARK_Lim}}$	Mark Sinking Current Limit	VVPWR - VDRAINn = 0 V	60	75	90	mA
t_{ME}	Mark Duration		6		12	ms

7.5 Electrical Characteristics (continued)

Conditions are $-40 < T_J < 125$ °C unless otherwise noted. $V_{VDD} = 3.3$ V, $V_{VPWR} = 54$ V, $V_{DGND} = V_{AGND}$, DGND, KSENSA, KSENSB, KSENSC and KSENSD connected to AGND, and all outputs are unloaded, $2x\text{FBn} = 0$. Positive currents are into pins. $R_S = 0.200$ Ω, to KSENSA (SEN1 or SEN2), to KSENSB (SEN3 or SEN4), to KSENSC (SEN5 or SEN6) or to KSENSD (SEN7 or SEN8). Typical values are at 25 °C. All voltages are with respect to AGND unless otherwise noted. Operating registers loaded with default values unless otherwise noted.

PARAMETER		TEST CONDITIONS	MIN	TYP	MAX	UNIT
DC DISCONNECT						
V_{IMIN}	DC disconnect threshold		0.8	1.3	1.8	mV
t_{MPDO}	PD Maintain Power signature dropout time limit	TMPDO = 00	320		400	ms
		TMPDO = 01	75		100	ms
		TMPDO = 10	150		200	ms
		TMPDO = 11	600		800	ms
t_{MPS}	PD Maintain Power Signature time for validity			2.5	3	ms
PORT POWER POLICING						
$\delta P_{CUT}/P_{CUT}$	PCUT tolerance	< 15 W	0	6	12	%
$\delta P_{CUT}/P_{CUT}$	PCUT tolerance	≥ 15 W	0	4	8	%
$t_{OVL D}$	PCUT time limit	TOVLD = 00	50		70	ms
		TOVLD = 01	25		35	
		TOVLD = 10	100		140	
		TOVLD = 11	200		280	
PORT CURRENT INRUSH						
V_{Inrush}	Inrush limit, ALTIRNn = 0	VVPWR - VDRAINn = 1 V	19	30	41	mV
		VVPWR - VDRAINn = 10 V	19	30	41	
		VVPWR - VDRAINn = 15 V	33	44	55	
		VVPWR - VDRAINn = 30 V	80		90	
		VVPWR - VDRAINn = 55 V	80		90	
	Inrush limit, ALTIRNn = 1	VVPWR - VDRAINn = 1 V	19	30	41	
		VVPWR - VDRAINn = 10 V	36	47	58	
		VVPWR - VDRAINn = 15 V	53	64	75	
		VVPWR - VDRAINn = 30 V	80		90	
		VVPWR - VDRAINn = 55 V	80		90	
t_{START}	Maximum current limit duration in start-up	TSTART = 00	50		70	ms
		TSTART = 01	25		35	
		TSTART = 10	100		140	

7.5 Electrical Characteristics (continued)

Conditions are $-40 < T_J < 125$ °C unless otherwise noted. $V_{VDD} = 3.3$ V, $V_{VPWR} = 54$ V, $V_{DGND} = V_{AGND}$, DGND, KSENSA, KSENSB, KSENSC and KSENSD connected to AGND, and all outputs are unloaded, $2x\text{FBn} = 0$. Positive currents are into pins. $R_S = 0.200$ Ω , to KSENSA (SEN1 or SEN2), to KSENSB (SEN3 or SEN4), to KSENSC (SEN5 or SEN6) or to KSENSD (SEN7 or SEN8). Typical values are at 25 °C. All voltages are with respect to AGND unless otherwise noted. Operating registers loaded with default values unless otherwise noted.

PARAMETER		TEST CONDITIONS	MIN	TYP	MAX	UNIT
PORT CURRENT FOLDBACK						
V_{LIM}	ILIM 1X limit, $2x\text{FBn} = 0$ and $\text{ALTFBn} = 0$	$\text{VDRAINn} = 1$ V	80		90	mV
		$\text{VDRAINn} = 15$ V	80		90	
		$\text{VDRAINn} = 30$ V	51	58	65	
		$\text{VDRAINn} = 50$ V	23	30	37	
	ILIM 1X limit, $2x\text{FBn} = 0$ and $\text{ALTFBn} = 1$	$\text{VDRAINn} = 1$ V	80		90	
		$\text{VDRAINn} = 25$ V	80		90	
		$\text{VDRAINn} = 40$ V	45	51	57	
		$\text{VDRAINn} = 50$ V	23	30	37	
V_{LIM2X}	ILIM 2X limit, $2x\text{FBn} = 1$ and $\text{ALTFBn} = 0$	$\text{VDRAINn} = 1$ V	245	250	262	mV
		$\text{VDRAINn} = 10$ V	164	180	196	
		$\text{VDRAINn} = 30$ V	51	58	64	
		$\text{VDRAINn} = 50$ V	23	30	37	
	ILIM 2X limit, $2x\text{FBn} = 1$ and $\text{ALTFBn} = 1$	$\text{VDRAINn} = 1$ V	245	250	262	
		$\text{VDRAINn} = 20$ V	139	147	155	
		$\text{VDRAINn} = 40$ V	45	51	57	
		$\text{VDRAINn} = 50$ V	23	30	37	
t_{LIM}	ILIM time limit	$2x\text{FBn} = 0$	55	60	65	ms
		$2x\text{FBn} = 1$	55	60	65	
	$2x\text{FBn} = 1$	TLIM = 00	15	16	17	
		TLIM = 01	10	11	12	
		TLIM = 11	6	6.5	7	
SHORT CIRCUIT DETECTION						
V_{short}	I_{SHORT} threshold in 1X mode and during inrush		205		245	mV
$V_{\text{short}2X}$	I_{SHORT} threshold in 2X mode		280		320	
$t_{D_off_SEN}$	Gate turnoff time from SENn input	$2x\text{FBn} = 0$, $\text{VDRAINn} = 1$ V From V_{SENn} pulsed to 0.425 V.			0.9	μs
		$2x\text{FBn} = 1$, $\text{VDRAINn} = 1$ V From V_{SENn} pulsed to 0.62 V.			0.9	
CURRENT FAULT RECOVERY (BACKOFF) TIMING						
t_{ed}	Error delay timing. Delay before next attempt to power a channel following power removal due to error condition	P_{CUT} , I_{LIM} or I_{inrush} fault semiauto mode	0.8	1	1.2	s
δI_{fault}	Duty cycle of I_{channel} with current fault		5.5		6.7	%
THERMAL SHUTDOWN						
	Shutdown temperature	Temperature rising	135	146		°C
	Hysteresis			7		°C

7.5 Electrical Characteristics (continued)

Conditions are $-40 < T_J < 125$ °C unless otherwise noted. $V_{VDD} = 3.3$ V, $V_{VPWR} = 54$ V, $V_{DGND} = V_{AGND}$, DGND, KSENSA, KSENSB, KSENSC and KSENSD connected to AGND, and all outputs are unloaded, $2x\text{FBn} = 0$. Positive currents are into pins. $R_S = 0.200$ Ω , to KSENSA (SEN1 or SEN2), to KSENSB (SEN3 or SEN4), to KSENSC (SEN5 or SEN6) or to KSENSD (SEN7 or SEN8). Typical values are at 25 °C. All voltages are with respect to AGND unless otherwise noted. Operating registers loaded with default values unless otherwise noted.

PARAMETER		TEST CONDITIONS	MIN	TYP	MAX	UNIT
DIGITAL I/O (SCL, SDAI, A1-A4, /RESET, OSS unless otherwise stated)						
V_{IH}	Digital input High		2.1			V
V_{IL}	Digital input Low				0.9	V
V_{IT_HYS}	Input voltage hysteresis		0.17			V
V_{OL}	Digital output Low	SDAO at 9mA			0.4	V
	Digital output Low	/INT at 3mA			0.4	V
R_{pullup}	Pullup resistor to VDD	/RESET, A1-A4, TEST0	30	50	80	k Ω
$R_{pulldown}$	Pulldown resistor to DGND	OSS, TEST1, TEST2	30	50	80	k Ω
t_{FLT_INT}	Fault to /INT assertion	Time to internally register an Interrupt fault, from Channel turn off		50	500	μ s
$T_{RESETmin}$	/RESET input minimum pulse width				5	μ s
T_{bit_OSS}	3-bit OSS bit period	MbitPrty = 1	24	25	26	μ s
t_{OSS_IDL}	Idle time between consecutive shutdown code transmission in 3-bit mode	MbitPrty = 1	48	50		μ s
t_{r_OSS}	Input rise time of OSS in 3-bit mode	0.8 V \rightarrow 2.3 V, MbitPrty = 1	1		300	ns
t_{f_OSS}	Input fall time of OSS in 3-bit mode	2.3 V \rightarrow 0.8 V, MbitPrty = 1	1		300	ns
I2C TIMING REQUIREMENTS						
t_{POR}	Device power-on reset delay				20	ms
f_{SCL}	SCL clock frequency		10		400	kHz
t_{LOW}	LOW period of the clock		0.5			μ s
t_{HIGH}	HIGH period of the clock		0.26			μ s
t_{fo}	SDAO output fall time	SDAO, 2.3 V \rightarrow 0.8 V, Cb = 10 pF, 10 k Ω pull-up to 3.3 V	10		50	ns
		SDAO, 2.3 V \rightarrow 0.8 V, Cb = 400 pF, 1.3 k Ω pull-up to 3.3 V	10		50	ns
C_{I2C}	SCL capacitance				10	pF
C_{I2C_SDA}	SDAI, SDAO capacitance				6	pF
t_{SU_DATW}	Data setup tme (Write operation)		50			ns
t_{HD_DATW}	Data hold time (Write operation)		0			ns
t_{HD_DATR}	Data hold time (Read operation)		150		400	ns
t_{f_SDA}	Input fall times of SDAI	2.3 V \rightarrow 0.8 V	20		120	ns
t_{r_SDA}	Input rise times of SDAI	0.8 V \rightarrow 2.3 V	20		120	ns
t_r	Input rise time of SCL	0.8 V \rightarrow 2.3 V	20		120	ns
t_f	Input fall time of SCL	2.3 V \rightarrow 0.8 V	20		120	ns
t_{BUF}	Bus free time between a STOP and START condition		0.5			μ s
t_{HD_STA}	Hold time After (Repeated) START condition		0.26			μ s
t_{SU_STA}	Repeated START condition setup time		0.26			μ s
t_{SU_STO}	STOP condition setup time		0.26			μ s
t_{DG}	Suppressed spike pulse width, SDAI and SCL		50			ns
t_{WDT_I2C}	I2C Watchdog trip delay		1.1	2.2	3.3	sec

7.6 Typical Characteristics

Conditions are $-40 < T_J < 125$ °C unless otherwise noted. $V_{DD} = 3.3$ V, $V_{PWR} = 54$ V, $V_{DGND} = V_{AGND}$, DGND, KSENSA, KSENSB, KSENSC and KSENSD connected to AGND, and all outputs are unloaded, $2x\text{FBn} = 0$. Positive currents are into pins. $R_S = 0.200$ Ω , to KSENSA (SEN1 or SEN2), to KSENSB (SEN3 or SEN4), to KSENSC (SEN5 or SEN6) or to KSENSD (SEN7 or SEN8). Typical values are at 25 °C. All voltages are with respect to AGND unless otherwise noted. Operating registers loaded with default values unless otherwise noted.



图 7-1. VPWR Current Consumption vs Temperature



图 7-2. VPWR UVLO Thresholds vs Temperature

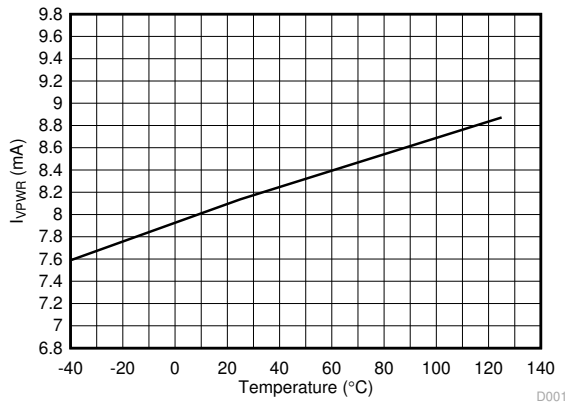

图 7-3. VPUV Thresholds vs Temperature

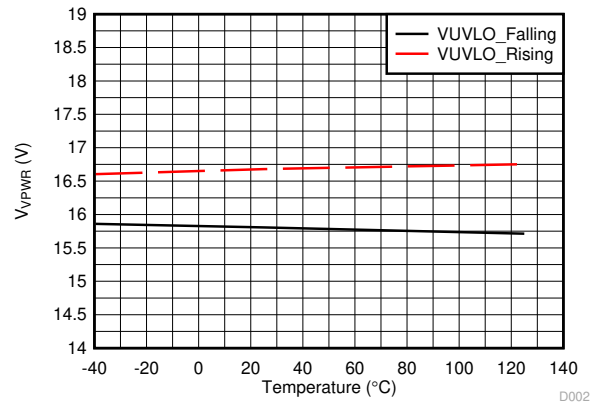

图 7-4. VDD Current Consumption vs Temperature

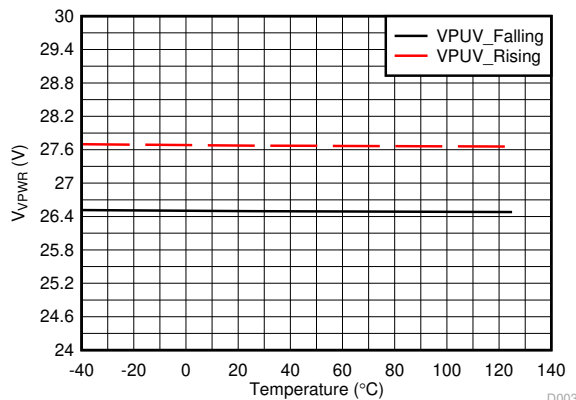

图 7-5. VDUV Thresholds vs Temperature

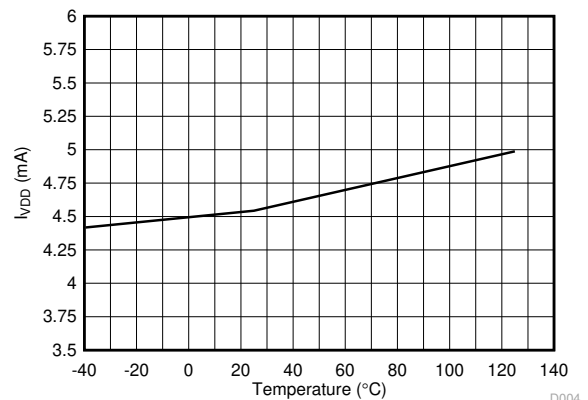

图 7-6. SENSE Pin Bias Current vs Temperature

7.6 Typical Characteristics (continued)

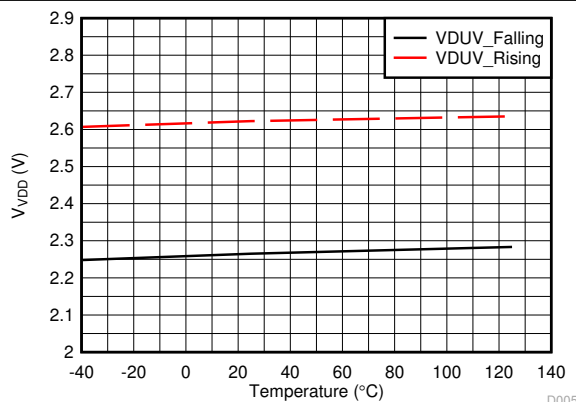
Conditions are $-40 < T_J < 125$ °C unless otherwise noted. $V_{DD} = 3.3$ V, $V_{PWR} = 54$ V, $V_{DGND} = V_{AGND}$, DGND, KSENSA, KSENSB, KSENSC and KSENSD connected to AGND, and all outputs are unloaded, $2x\text{FBn} = 0$. Positive currents are into pins. $R_S = 0.200$ Ω , to KSENSA (SEN1 or SEN2), to KSENSB (SEN3 or SEN4), to KSENSC (SEN5 or SEN6) or to KSENSD (SEN7 or SEN8). Typical values are at 25 °C. All voltages are with respect to AGND unless otherwise noted. Operating registers loaded with default values unless otherwise noted.

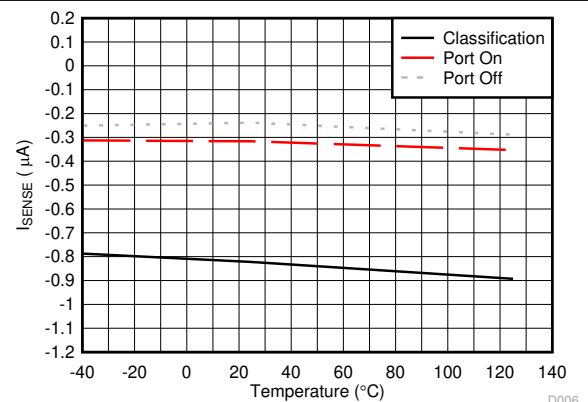

图 7-7. Discovery Currents vs Temperature



图 7-8. Discovery Resistance Measurement vs Temperature

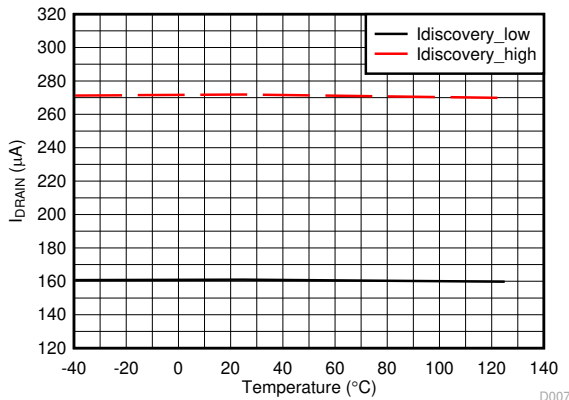

图 7-9. Discovery Open Circuit Voltage vs Temperature

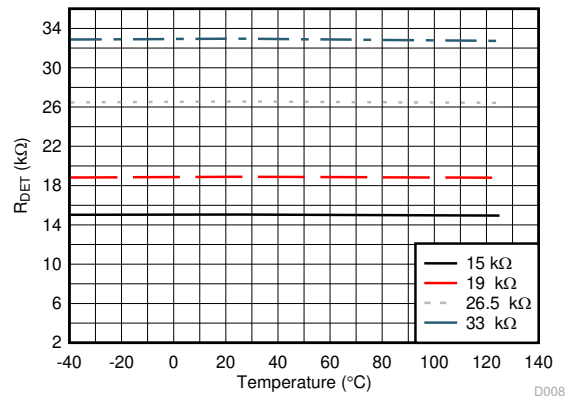

图 7-10. Classification Voltage vs I_{CLASS} and Temperature

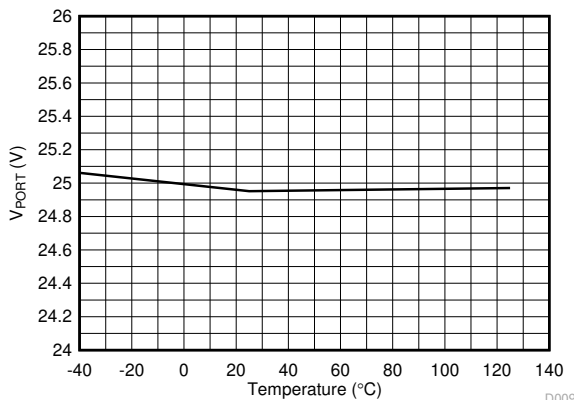

图 7-11. Mark Voltage vs I_{MARK} and Temperature

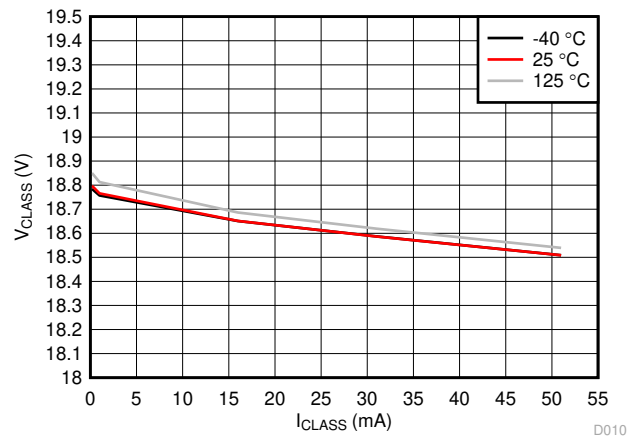

图 7-12. Classification and Mark Current Limit vs Temperature

7.6 Typical Characteristics (continued)

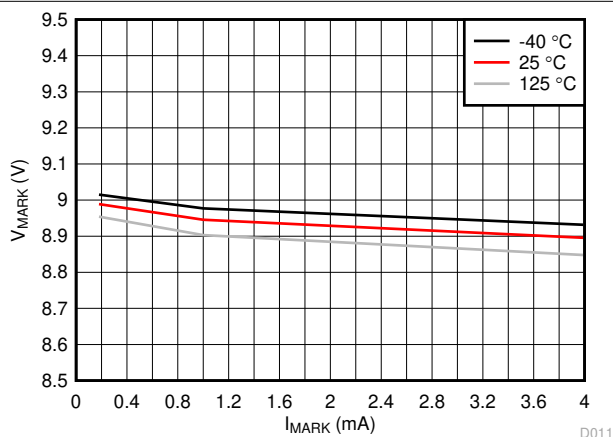
Conditions are $-40 < T_J < 125$ °C unless otherwise noted. $V_{VDD} = 3.3$ V, $V_{VPWR} = 54$ V, $V_{DGND} = V_{AGND}$, DGND, KSENSA, KSENSB, KSENSC and KSENSD connected to AGND, and all outputs are unloaded, $2x\text{FBn} = 0$. Positive currents are into pins. $R_S = 0.200$ Ω, to KSENSA (SEN1 or SEN2), to KSENSB (SEN3 or SEN4), to KSENSC (SEN5 or SEN6) or to KSENSD (SEN7 or SEN8). Typical values are at 25 °C. All voltages are with respect to AGND unless otherwise noted. Operating registers loaded with default values unless otherwise noted.

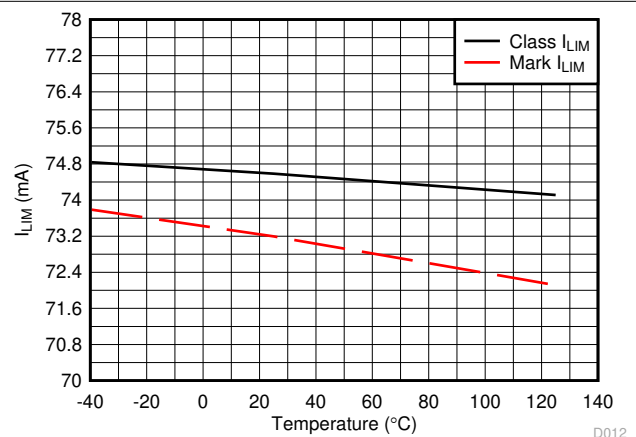

图 7-13. Power Good Threshold vs Temperature



图 7-14. Gate Voltage (Port On) vs Temperature

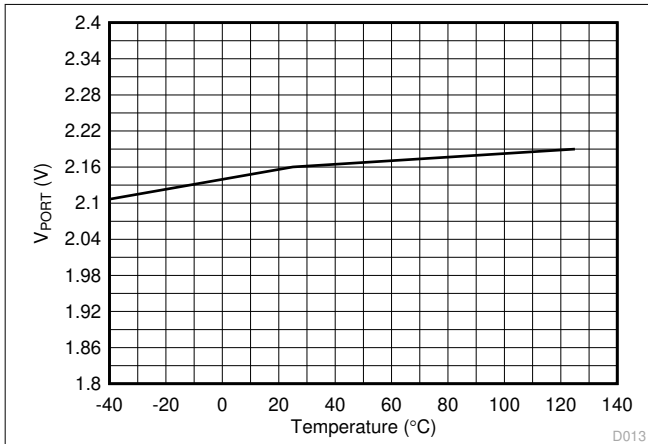

图 7-15. Port Voltage ADC Measurement vs Temperature

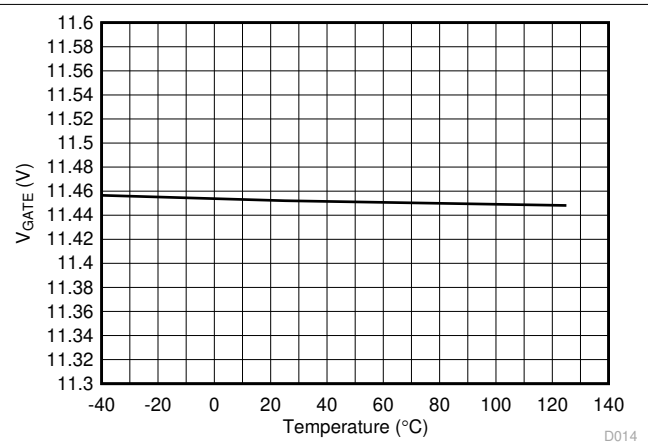

图 7-16. VPWR Voltage ADC Measurement vs Temperature

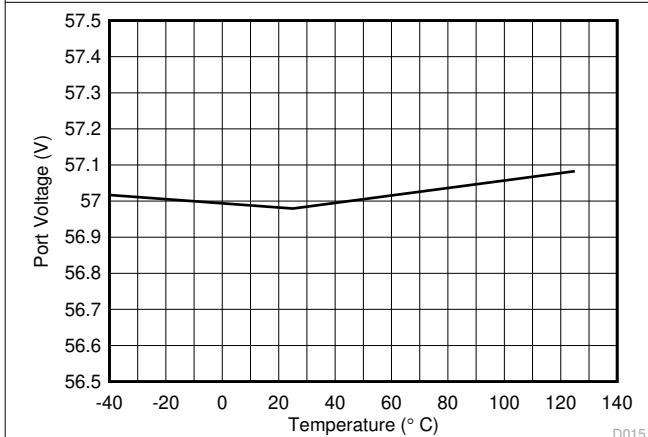

图 7-17. Port Current ADC Measurement (100mA) vs Temperature

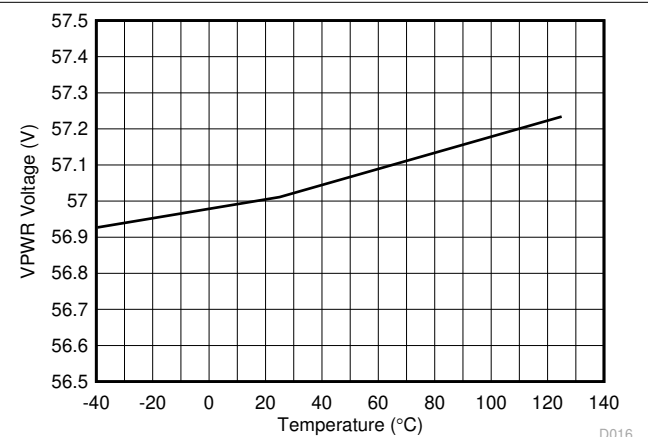

图 7-18. Port Current ADC Measurement (770mA) vs Temperature

7.6 Typical Characteristics (continued)

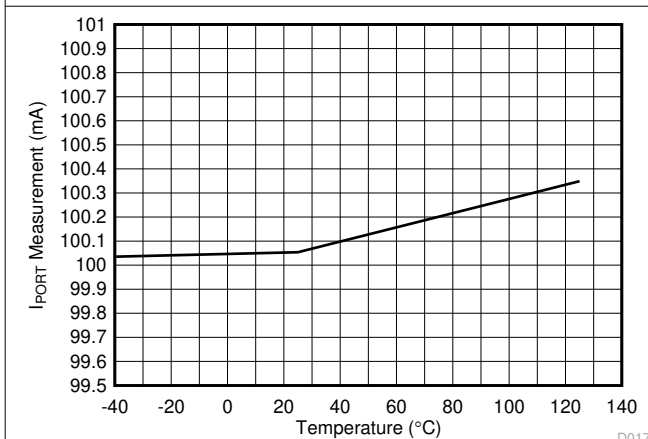
Conditions are $-40 < T_J < 125\text{ }^\circ\text{C}$ unless otherwise noted. $V_{DD} = 3.3\text{ V}$, $V_{PWR} = 54\text{ V}$, $V_{DGND} = V_{AGND}$, DGND, KSENSA, KSENSB, KSENSC and KSENSD connected to AGND, and all outputs are unloaded, $2x\text{FBn} = 0$. Positive currents are into pins. $R_S = 0.200\ \Omega$, to KSENSA (SEN1 or SEN2), to KSENSB (SEN3 or SEN4), to KSENSC (SEN5 or SEN6) or to KSENSD (SEN7 or SEN8). Typical values are at $25\text{ }^\circ\text{C}$. All voltages are with respect to AGND unless otherwise noted. Operating registers loaded with default values unless otherwise noted.

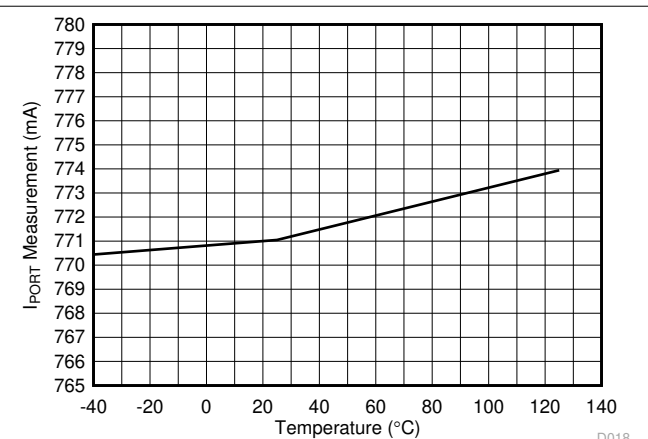

图 7-19. Port Current ADC Measurement (1 A) vs Temperature



图 7-20. P_Cut Threshold (30W) vs Temperature

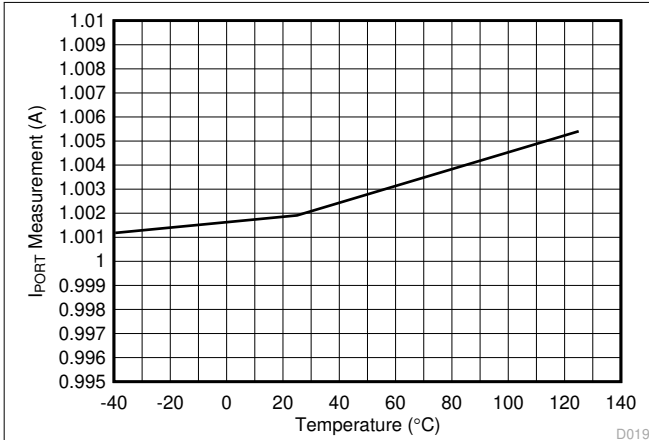

图 7-21. Inrush Current Limit vs Temperature

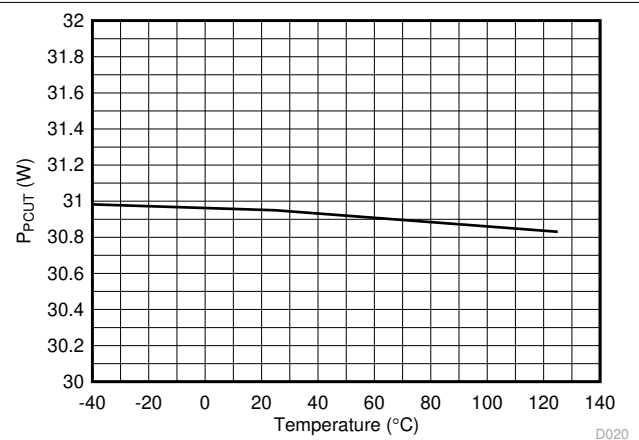

图 7-22. 1x Mode (2xFBn = 0) Current Limit vs Temperature

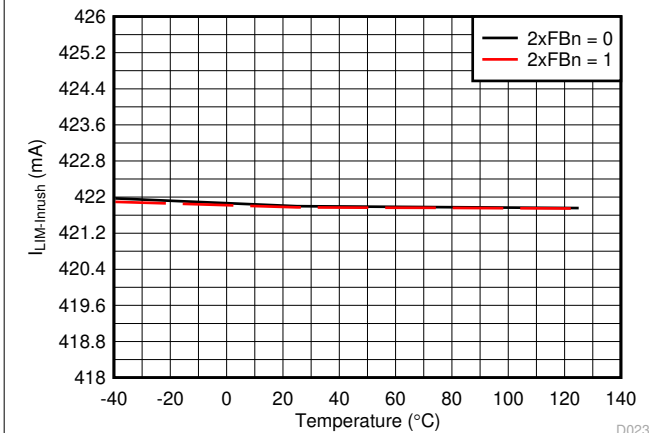

图 7-23. 2x Mode (2xFBn = 1) Current Limit vs Temperature

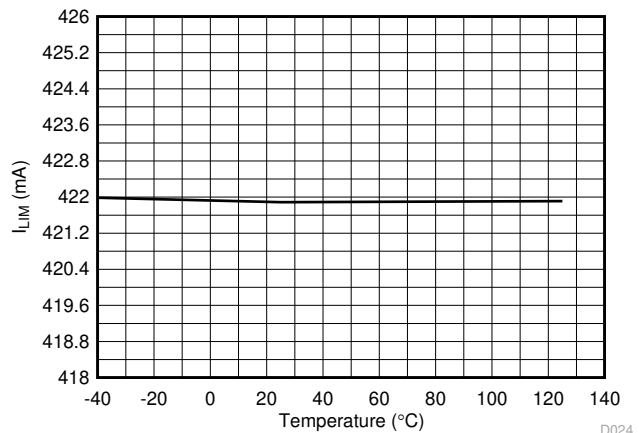

图 7-24. I_SHORT Threshold vs Temperature

7.6 Typical Characteristics (continued)

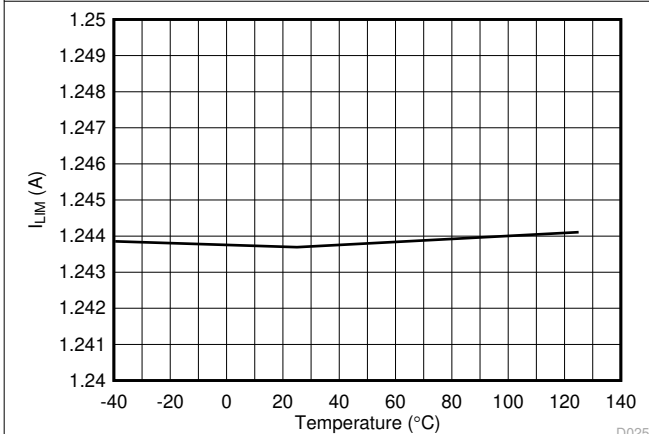
Conditions are $-40 < T_J < 125\text{ }^\circ\text{C}$ unless otherwise noted. $V_{DD} = 3.3\text{ V}$, $V_{PWR} = 54\text{ V}$, $V_{DGND} = V_{AGND}$, DGND, KSENSA, KSENSB, KSENSC and KSENSD connected to AGND, and all outputs are unloaded, $2x\text{FBn} = 0$. Positive currents are into pins. $R_S = 0.200\text{ }\Omega$, to KSENSA (SEN1 or SEN2), to KSENSB (SEN3 or SEN4), to KSENSC (SEN5 or SEN6) or to KSENSD (SEN7 or SEN8). Typical values are at $25\text{ }^\circ\text{C}$. All voltages are with respect to AGND unless otherwise noted. Operating registers loaded with default values unless otherwise noted.

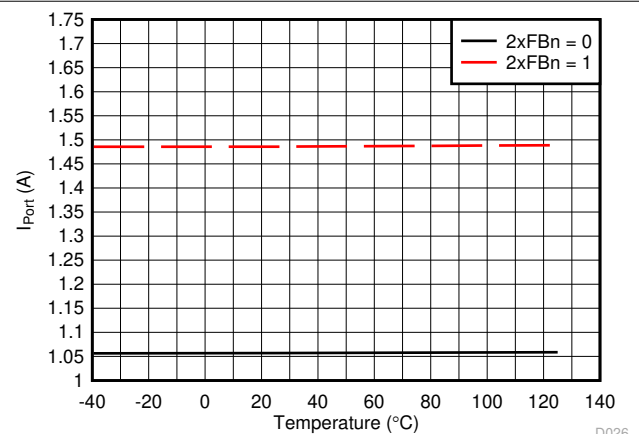

图 7-25. R_{OFF} (VPWR to DRAIN) vs Temperature



图 7-26. Inrush Current Foldback vs Port Voltage

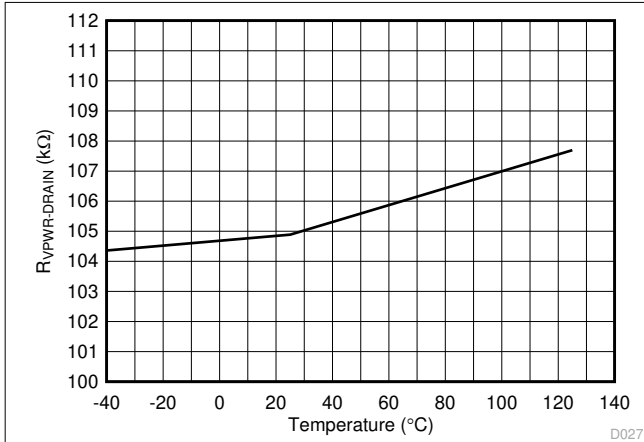

图 7-27. 1x Mode (2xFBn = 0) Current Foldback vs Drain Voltage

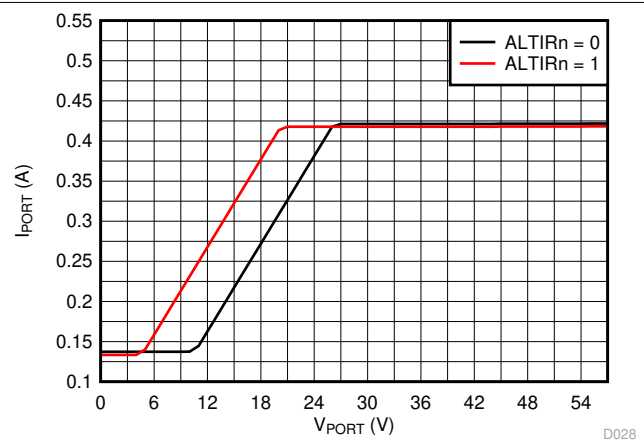

图 7-28. 2x Mode (2xFBn = 1) Current Foldback vs Drain Voltage

8 Parameter Measurement Information

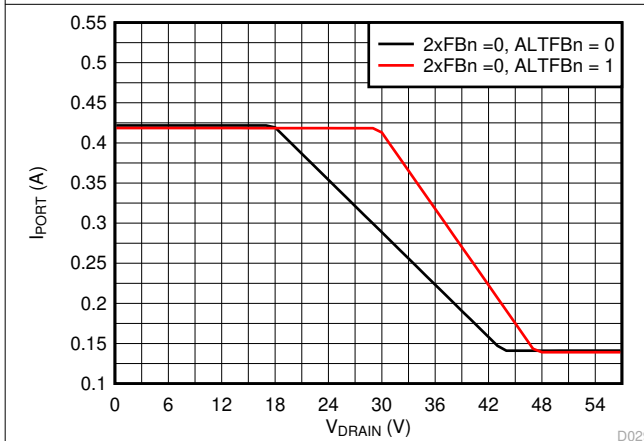
8.1 Timing Diagrams

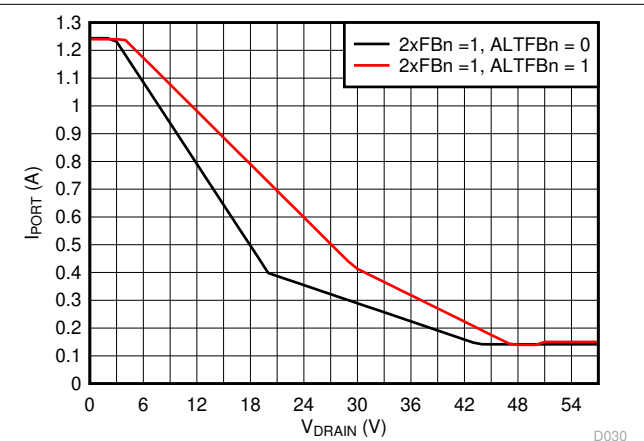

图 8-1. I²C Timings



图 8-2. Overcurrent Fault Timing

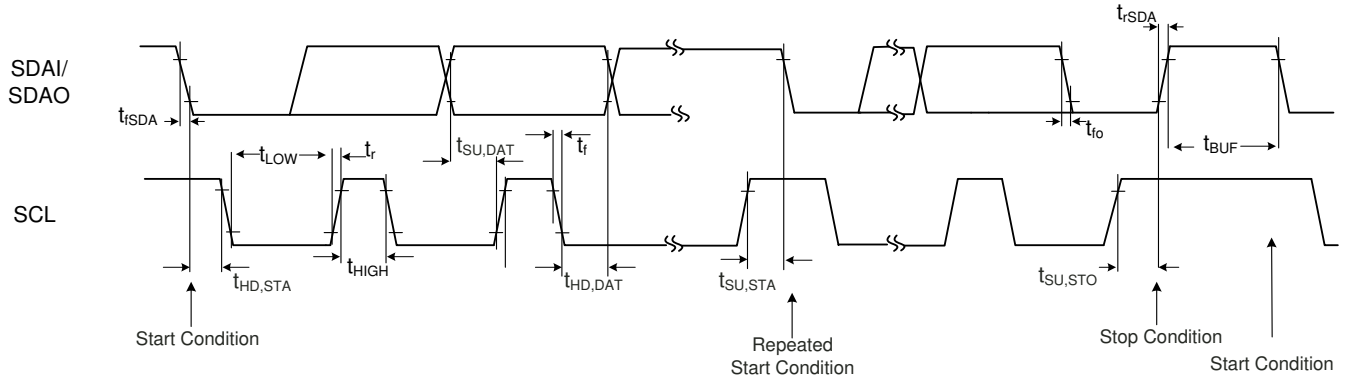

图 8-3. 2-Pair Detection, 1-Event Classification and Turn On

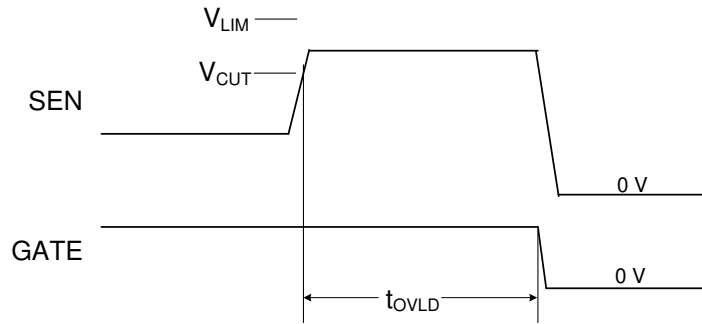

图 8-4. 2-Pair Detection, 3-Event Classification and Turn-On

9 Detailed Description

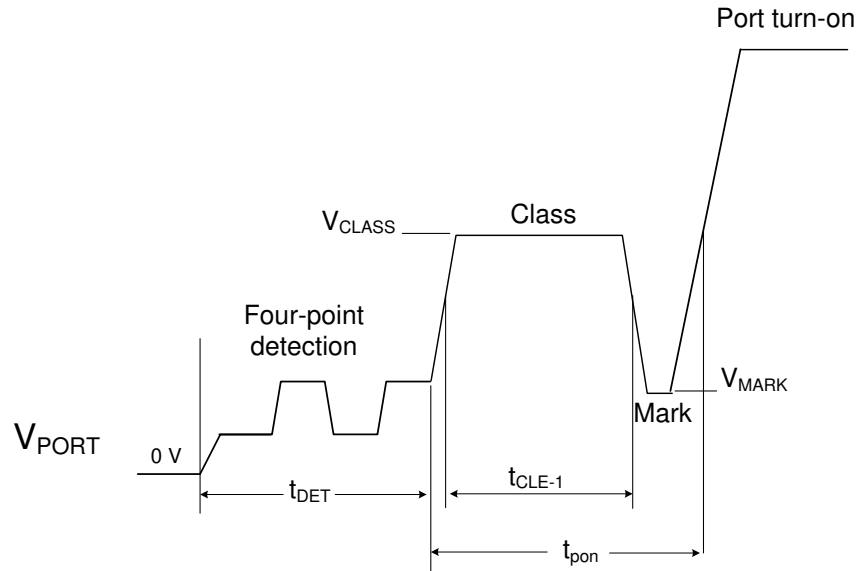
9.1 Overview

The TPS23882B is an eight-channel PSE for Power over Ethernet applications. Each of the eight channels provides detection, classification, protection, and shutdown in compliance with the IEEE 802.3bt standard.

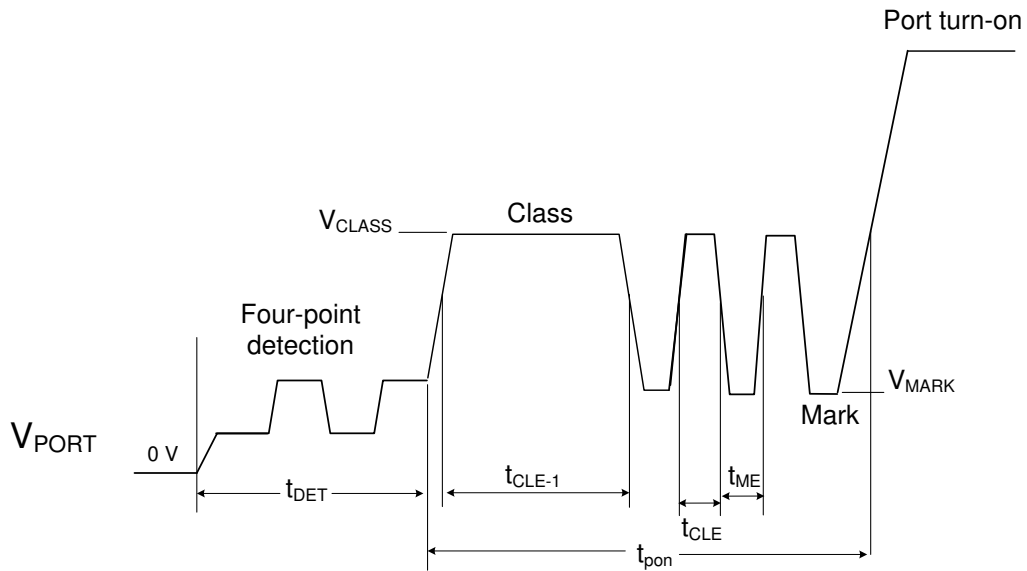
Basic PoE features include the following:

- Performs high-reliability 4-point load detection
- Performs multi-finger classification including the 100-ms long first class finger for autoclass discovery and to identify as a 802.3bt complainant PSE
- Enables power with protective foldback current limiting and an adjustable P_{CUT} threshold
- Shuts down during faults such as overcurrent or outputs shorts
- Performs a maintain power signature function to ensure power is removed if the load is disconnected
- Undervoltage lockout occurs if $VPWR$ falls below V_{PUV_F} (typical 26.5 V)

Enhanced features include the following:

- Programmable SRAM memory
- Dedicated 14-bit integrating current ADCs per port
- Port re-mapping capability
- 8- and 16-bit access mode selectable
- 1- and 3-bit port shutdown priority

9.1.1 Operating Modes

9.1.1.1 Auto

The port performs detection and classification (if valid detection occurs) continuously. Registers are updated each time a detection or classification occurs. The port power is automatically turned on based on the Power Allocation settings in register 0x29 if a valid classification is measured.

9.1.1.2 Autonomous

Unlike auto mode, which still requires a host to initialize the TPS23882B operation through a series of I²C commands, there is no host or I²C communication required when the device is in configured in autonomous mode.

During power up, the resistance on the AUTO pin (R_{AUTO}) is measured, and the device is pre-configured according to [表 9-15](#). The port automatically performs detection and classification (if valid detection occurs) continuously on all ports. Port power is automatically turned on based on power allocation settings in register 0x29 if a valid classification is measured.

For applications that still require port telemetry, the I²C functionality is still supported in autonomous mode.

备注

A 10-nF capacitor is required in parallel with R_{AUTO} to ensure stability in the autonomous mode selection.

The auto pin resistance (R_{AUTO}) is measured following a device reset (assertion of the \overline{RESET} pin or RESAL bit in register 0x1A). The device only measures (R_{AUTO}) and pre-configures the internal registers during power up (V_{VPWR} and V_{VDD} rising above their respective UVLO thresholds).

备注

The device SRAM must be programmed to support applications that desire to remove a device from autonomous mode after having initially powered up in autonomous mode.

A device running from the internal ROM (SRAM unprogrammed) in autonomous mode turns off and automatically resume discovery and power on any valid loads following the assertion of the $\overline{\text{RESET}}$ pin, I2C register 0x1A RESAL or RESPn bits, or a mode off command. Whereas a device running in autonomous mode with the SRAM programmed turns off and remains inactive until the host re-enables the ports through the I²C bus.

9.1.1.3 Semiauto

The port performs detection and classification (if valid detection occurs) continuously. Registers are updated each time a detection or classification occurs. The port power is not automatically turned on. A Power Enable command is required to turn on the port.

9.1.1.4 Manual and Diagnostic

The use of this mode is intended for system diagnostic purposes only in the event that ports cannot be powered in accordance with the IEEE 802.3bt standard from semiauto or auto modes.

The port performs the functions as configured in the registers. There is no automatic state change. Singular detection and classification measurements are performed when commanded. Ports are turned on immediately after a Power Enable command without any detection or classification measurements. Even though multiple classification events can be provided, the port voltage resets immediately after the last finger, resetting the PD.

9.1.1.5 Power Off

The port is powered off and does not perform a detection, classification, or power-on. In this mode, status and enable bits for the associated port are reset.

9.1.2 PoE Compliance Terminology

With the release of the IEEE 802.3bt standard, compliant PoE equipment has expanded to include four different *Types* of devices that support power over 2 pair or 4 pair, in either single or dual signature configurations, with classifications ranging from 0 to 8. Different manufactures have used varying terminology over time to describe their equipment capabilities, and it can become difficult to identify how to correctly categorize and brand a particular piece of equipment. For this reason and in conjunction with the Ethernet Alliance (EA), the industry leading providers of PoE equipment and devices have agreed to transition to using the "PoE 1" and "PoE 2" banding per [表 9-1](#) below.

表 9-1. Summary Table of PoE Compliance Terminology

Brand, Acronym	IEEE Standard	Clause	Clause Title	Types	Classes	EA Certified Logo
PoE 1	802.3af	33	Power over Ethernet over 2 pairs	1	0 - 3	Gen 1 Class 1-4
	802.3at			2	0 - 4	
PoE 2	802.3bt	145	Power over Ethernet	3	1 - 6, or 1-4 DS ⁽¹⁾	Gen 2 Class 1-8
				4	7 - 8, or 5 DS ⁽¹⁾	

(1) "DS" is used to designate "Dual Signature" PDs.

备注

By design PoE 2 PSEs are fully interoperable with any existing PoE 1 equipment, and although not all functionality may be enabled, PoE 2 PDs connected to PoE 1 PSEs are required to limit their power consumption to the PSE presented power capabilities. See [Power Allocation and Power Demotion](#).

9.1.3 PoE 2 Type-3 2-Pair PoE

Upon release of the new IEEE 802.3bt standard, the IEEE introduced two new "Types" of PoE equipment. The addition of Type-3 and Type-4 equipment are most commonly associated with the addition of 4-Pair PoE and their available power increases of to up to 90 W sourced from a PSE port. However, the new PoE 2 Type-3 designation also applies to new 2-Pair PoE equipment as well. Most notably, the new 802.3bt standard supports a reduced T_{MPS} time (6 ms versus 60 ms) and a new feature called Autoclass, and by definition any device that supports these new features is designated as Type-3 equipment even if power is only provided over 2 pairs (one alternative pairset) in an Ethernet cable. Because the TPS23882B supports these new features including its use of the 100-ms long first class finger to identify itself as an IEEE 802.3bt PSE, it is officially classified as a Type-3 PSE even through power delivery is limited to 2 pair.

Please note that as the 802.3at standard created "Type-2" equipment that was fully interoperable with the previous PoE 1 Type-1 (802.3af) equipment, any new 802.3bt Type-3 equipment including the TPS23882B is fully operable with any existing PoE 1 Type-1 (.af) and Type-2 (.at) equipment.

9.1.4 Requested Class Versus Assigned Class

The *requested* class is the classification the PSE measures during mutual identification prior to turn-on, whereas the *assigned* class is the classification level the channel was powered on with based on the power allocation setting in register 0x29h. In most cases where the power allocation equals or exceeds the *requested* class, the *requested* and *assigned* classes is the same. However, in the case of power demotion, these values differ.

For example: If a 4-pair Class 8 PD is connected to a 30-W (Class 4) configured PSE port, the *requested* class reports "Class 8", while the *assigned* class reports "Class 4".

The *requested* classification results are available in registers 0x0C-0F.

The *assigned* classification results are available in registers 0x4C-4F.

备注

There is no Assigned Class assigned for ports and channels powered out of manual and diagnostic mode.

9.1.5 Power Allocation and Power Demotion

The Power Allocation settings in register 0x29 sets the maximum power level a port powers on. Settings for each class level from 2-pair 4 W (Class 1) up to 2-pair 30 W (Class 4) have been provided to maximize system design flexibility.

备注

The Power Allocation settings in register 0x29 do not set the power limit for a given port. The port and channel power limiting is configured with the 2P (registers 0x1E- x 21) policing registers

During a turn-on attempt, if a PD presents a classification level greater than the power allocation setting for a port, the TPS23882B limits the number of classification fingers presented to the PD prior to turn on based on the power allocation settings in register 0x29. This behavior is called *Power Demotion* as it is the number of fingers presented to the PD that sets the maximum level of power the PD is allowed to draw before the PSE is allowed to disable it.

备注

The IEEE 802.3 standard requires PDs that are power demoted by a PSE to limit their total power draw below the Type/class level set by the number of fingers presented by the PSE during mutual identification.

In a 2-pair system, Power demotion is limited to either 30 W (3-fingers) or 15.4 W (1-finger) as there is no other physical means of indicating to a PD over the physical layer that less than 15.4 W is available.

If register 0x29 is configured for either 4 W (class 1) or 7 W (Class 2), and a class 3 or higher device is connected, the port is not powered and a Start Fault is reported along with an "Insufficient Power" indication provided in register 0x24.

表 9-2. 2-Pair Power Demotion Table

Power Allocation Register 0x29	Assigned Class Value (Based on the PD Connected at the Port)				
	Class 1 PD	Class 2 PD	Class 3 PD	Class 4 PD	Class 5+ PDs
2-Pair 4 W	Class 1	Start Fault Insufficient Power	Start Fault Insufficient Power	Start Fault Insufficient Power	Start Fault Insufficient Power
2-Pair 7 W	Class 1	Class 2	Start Fault Insufficient Power	Start Fault Insufficient Power	Start Fault Insufficient Power
2-Pair 15.5 W	Class 1	Class 2	Class 3	Class 3	Class 3

表 9-2. 2-Pair Power Demotion Table (continued)

Power Allocation Register 0x29	Assigned Class Value (Based on the PD Connected at the Port)				
	Class 1 PD	Class 2 PD	Class 3 PD	Class 4 PD	Class 5+ PDs
2-Pair 30 W	Class 1	Class 2	Class 3	Class 4	Class 4

9.1.6 Programmable SRAM

The TPS23882B device has been designed to include programmable SRAM that accommodates future firmware updates to support interoperability and compliance issues that can arise as new equipment is introduced in conjunction with the release of the IEEE 802.3bt standard.

备注

The latest version of firmware and SRAM release notes can be accessed from the [TI mySecure Software](#) web page.

The SRAM release notes and ROM advisory document includes more detailed information regarding any known issues and changes that were associated with each firmware release.

Upon power up, it is recommended that the TPS23882B device's SRAM be programmed with the latest version of SRAM code via the I²C to ensure proper operation and IEEE complaint performance. All I²C traffic other than those commands required to program the SRAM should be deferred until after the SRAM programming sequences are completed.

For systems that include multiple TPS23882B devices, the 0x7F "global" broadcast I2C address can be used to program all of the devices at the same time.

For more detailed instructions on the SRAM programming procedures, please refer to [SRAM CONTROL Register](#) and the [How to Load TPS2388x SRAM and Parity Code Over I²C application brief](#) on TI.com.

9.2 Functional Block Diagram

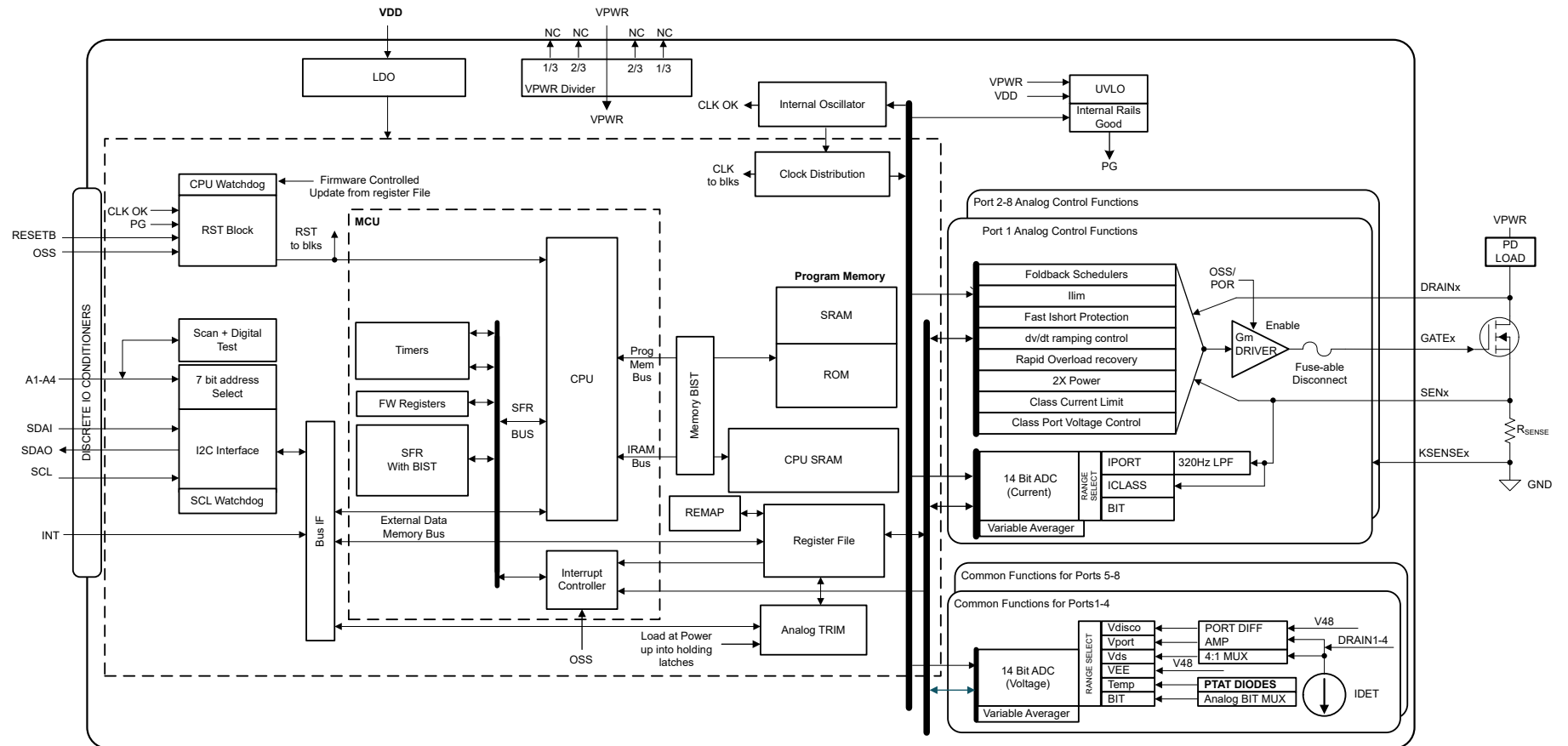

9.3 Feature Description

9.3.1 Port Remapping

The TPS23882B provides port remapping capability, from the logical ports to the physical channels and pins.

The remapping is between any channel of a 4-port group (1 to 4, 5 to 8).

The following example is applicable to 0x26 register = 00111001, 00111001b.

- Logical port 1 (5) ↔ Physical channel 2 (6)
- Logical port 2 (6) ↔ Physical channel 3 (7)
- Logical port 3 (7) ↔ Physical channel 4 (8)
- Logical port 4 (8) ↔ Physical channel 1 (5)

备注

The device ignores any remapping command unless all four ports are in off mode.

If the TPS23882B receives an incorrect configuration, it ignores the incorrect configuration and retains the previous configuration. The ACK is sent as usual at the end of communication. For example, if the same remapping code is received for more than one port, then a read back of the Re-Mapping register (0x26) is the last valid configuration.

Note that if an IC reset command (1Ah register) is received, the port remapping configuration is kept unchanged. However, if there is a Power-on Reset or if the RESET pin is activated, the Re-Mapping register is reinitialized to a default value.

9.3.2 Port Power Priority

The TPS23882B supports 1- and 3-bit shutdown priority, which are selected with the MbitPrty bit of General Mask register (0x17).

The 1-bit shutdown priority works with the Port Power Priority (0x15) register. An OSSn bit with a value of 1 indicates that the corresponding port is treated as low priority, while a value of 0 corresponds to a high priority. As soon as the OSS input goes high, the low-priority ports are turned off.

The 3-bit shutdown priority works with the Multi Bit Power Priority (0x27/28) register, which holds the priority settings. A port with “000” code in this register has highest priority. Port priority reduces as the 3-bit value increases, with up to 8 priority levels. See 图 9-1.

The multi bit port priority implementation is defined as the following:

- OSS code ≤ Priority setting (0x27/28 register): Port is disabled
- OSS code > Priority setting (0x27/28 register): Port remains active



图 9-1. Multi Bit Priority Port Shutdown if Lower-Priority Port

备注

Prior to setting the MbitPrty bit from 0 to 1, make sure the OSS input is in the idle (low) state for a minimum of 200 μ s, to avoid any port misbehavior related to loss of synchronization with the OSS bit stream.

备注

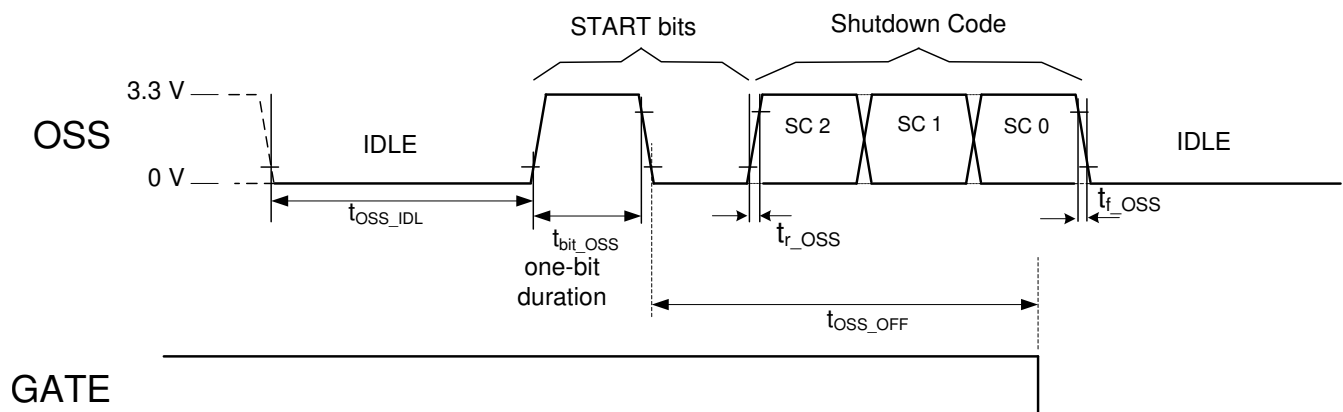
The OSS input has an internal 1- μ s to 5- μ s deglitch filter. From the idle state, a pulse with a longer duration is interpreted as a valid start bit. Ensure that the OSS signal is noise free.

9.3.3 Analog-to-Digital Converters (ADC)

The TPS23882B features 10 multi-slope integrating converters. Each of the first eight converters is dedicated to current measurement for one channel and operate independently to perform measurements during classification and when the channel is powered on. When the channel is powered, the converter is used for current (100-ms averaged) monitoring, power policing, and DC disconnect. Each of the last two converters are shared within a group of four channels for discovery (16.6-ms averaged), port powered voltage monitoring, power-good status, and FET short detection. These converters are also used for general-purpose measurements including input voltage (1 ms) and die temperature.

The ADC type used in the TPS23882B differs from other similar types of converters in that the ADCs continuously convert while the input signal is sampled by the integrator, providing inherent filtering over the conversion period. The typical conversion time of the current converters is 800 μ s, while the conversion time is 1 ms for the other converters. Powered-device detection is performed by averaging 16 consecutive samples which provides significant rejection of noise at 50-Hz or 60-Hz line frequency. While a port is powered, digital averaging provides a channel current measurement integrated over a 100-ms time period. Note that an anti-aliasing filter is present for powered current monitoring.

备注

During powered mode, current conversions are performed continuously. Also, in powered mode, the t_{START} timer must expire before any current or voltage ADC conversion can begin.

9.3.4 I²C Watchdog

An I²C Watchdog timer is available on the TPS23882B device. The timer monitors the I²C, SCL line for clock edges. When enabled, a timeout of the watchdog resets the I²C interface along with any active ports. This feature provides protection in the event of a hung software situation or I²C bus hang-up by target devices. In the latter case, if a target is attempting to send a data bit of 0 when the controller stops sending clocks, then the target may drive the data line low indefinitely. Because the data line is driven low, the controller cannot send a STOP to clean up the bus. Activating the I²C watchdog feature of the TPS23882B clears this deadlocked condition. If the timer of two seconds expires, the ports latch off and the WD status bit is set. Note that WD Status is set even if the watchdog is not enabled. The WD status bit can only be cleared by a device reset or writing a 0 to the WDS status bit location. The 4-bit watchdog disable field shuts down this feature when a code of 1011b is loaded. This field is preset to 1011b whenever the TPS23882B is initially powered. See [I²C WATCHDOG Register](#) for more details.

9.3.5 Current Foldback Protection

The TPS23882B features two types of foldback mechanisms for complete MOSFET protection.

During inrush, at channel turn-on, the foldback is based on the channel voltage as shown in 图 9-2. Note that the inrush current profile remains the same, regardless of the state of the 2xFBn bits in register 0x40.

After the channel is powered and the Power Good is valid, a dual-slope operational foldback is used, providing protection against partial and total short-circuit at port output, while still being able to maintain the PD powered during normal transients at the PSE input voltage. Note that setting the 2xFBn bit selects the 2x curve and clearing it selects the 1x curve. See 图 9-3.

In addition to the default foldback curves, the TPS23882B has individually enabled *alternative* foldback curves for both inrush and powered operation. These curves have been designed to accommodate certain loads that do not fully comply with the IEEE standard and requires additional power to be turned on or remain powered. See 图 9-2 and 图 9-3.

备注

If using the Alternative Foldback curves (ALTIRn or ALTFBn = 1), designers must account for the additional power dissipation that can occur in the FETs under these conditions.

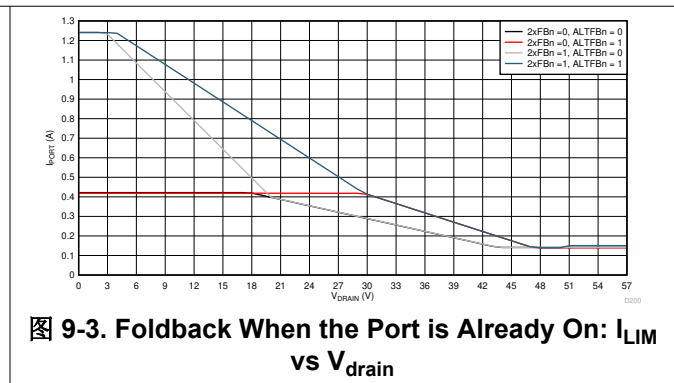
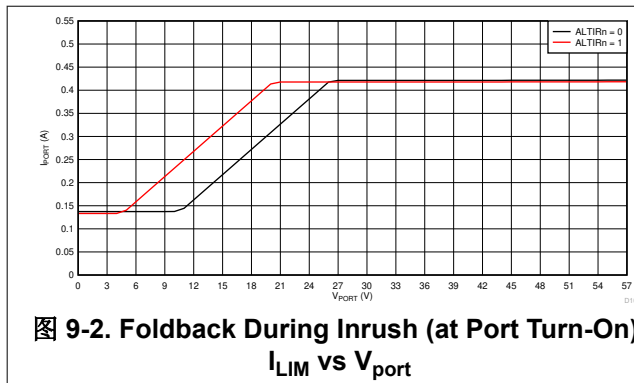

9.4 Device Functional Modes

9.4.1 Detection

To eliminate the possibility of false detection, the TPS23882B uses a TI proprietary 4-point detection method to determine the signature resistance of the PD device. A false detection of a valid 25-k Ω signature can occur with 2-point detection type PSEs in noisy environments or if the load is highly capacitive.

Detection 1 and Detection 2 are merged into a single detection function which is repeated. Detection 1 applies I1 (160 μ A) to a channel, waits approximately 60 ms, then measures the channel voltage (V1) with the integrating ADC. Detection 2 then applies I2 (270 μ A) to the channel, waits another approximately 60 ms, then measures the channel voltage again (V2). The process is then repeated a second time to capture a third (V3) and fourth (V4) channel voltage measurements. Multiple comparisons and calculations are performed on all four measurement point combinations to eliminate the effects of a nonlinear or hysteretic PD signature. The resulting channel signature is then sorted into the appropriate category.

备注

The detection resistance measurement result is also available in the Channel Detect Resistance registers (0x44 - 0x47).

9.4.2 Classification

Hardware classification (class) is performed by supplying a voltage and sampling the resulting current. To eliminate the high power of a classification event from occurring in the power controller chip, the TPS23882B uses the external power FET for classification.

During classification, the voltage on the gate node of the external MOSFET is part of a linear control loop. The control loop applies the appropriate MOSFET drive to maintain a differential voltage between VPWR and DRAIN of 18.5 V. During classification the voltage across the sense resistor in the source of the MOSFET is measured and converted to a class level within the TPS23882B. If a load short occurs during classification, the MOSFET gate voltage reduces to a linearly controlled, short-circuit value for the duration of the class event.

Classification results are read through the I²C Detection Event and Channel-n Discovery Registers. The TPS23882B also supports 1, and 3 finger classification for PDs ranging from Class 0 through Class 4, using the Power Enable and Port Power Allocation registers. Additionally, by providing a 3rd class finger during discovery in semiauto mode, the TPS23882B is capable of identifying if a 4-pair Class 5-8 PD is connected to the port.

9.4.3 DC Disconnect

Disconnect is the automated process of turning off power to the port. When the port is unloaded or at least falls below minimum load, it is required to turn off power to the port and restart detection. In DC disconnect, the voltage across the sense resistors is measured. When enabled, the DC disconnect function monitors the sense resistor voltage of a powered port to verify the port is drawing at least the minimum current to remain active. The T_{DIS} timer counts up whenever the port current is below the disconnect threshold (6.5-mA typical). If a timeout occurs, the port is shut down and the corresponding disconnect bit in the Fault Event Register is set. In the case of a PD implementing MPS (maintain Power Signature) current pulsing, the T_{DIS} counter is reset each time the current goes continuously higher than the disconnect threshold for at least 3 ms.

The T_{DIS} duration is set by the T_{MPDO} Bits of the Timing Configuration register (0x16).

9.5 I²C Programming

9.5.1 I²C Serial Interface

The TPS23882B features a 3-wire I²C interface, using SDAI, SDAO, and SCL. Each transmission includes a START condition sent by the controller, followed by the device address (7-bit) with R/W bit, a register address byte, then one or two data bytes and a STOP condition. The recipient sends an acknowledge bit following each byte transmitted. SDAI/SDAO is stable while SCL is high except during a START or STOP condition.

图 9-4 and 图 9-5 show read and write operations through I²C interface, using configuration A or B (see 表 9-24 for more details). The parametric read operation is applicable to ADC conversion results. The TPS23882B features quick access to the latest addressed register through I²C bus. When a STOP bit is received, the register pointer is not automatically reset.

It is also possible to perform a write operation to many TPS23882B devices at the same time. The target address during this broadcast access is 0x7F, as shown in [PIN STATUS Register](#). Depending on which configuration (A or B) is selected, a global write proceeds as following:

- Config A: Both 4-port devices (1 to 4 and 5 to 8) are addressed at same time.
- Config B: The whole device is addressed.



图 9-4. I²C interface Read and Write Protocol - Configuration A

TPS23882B

ZHCSNB6A - APRIL 2021 - REVISED FEBRUARY 2022

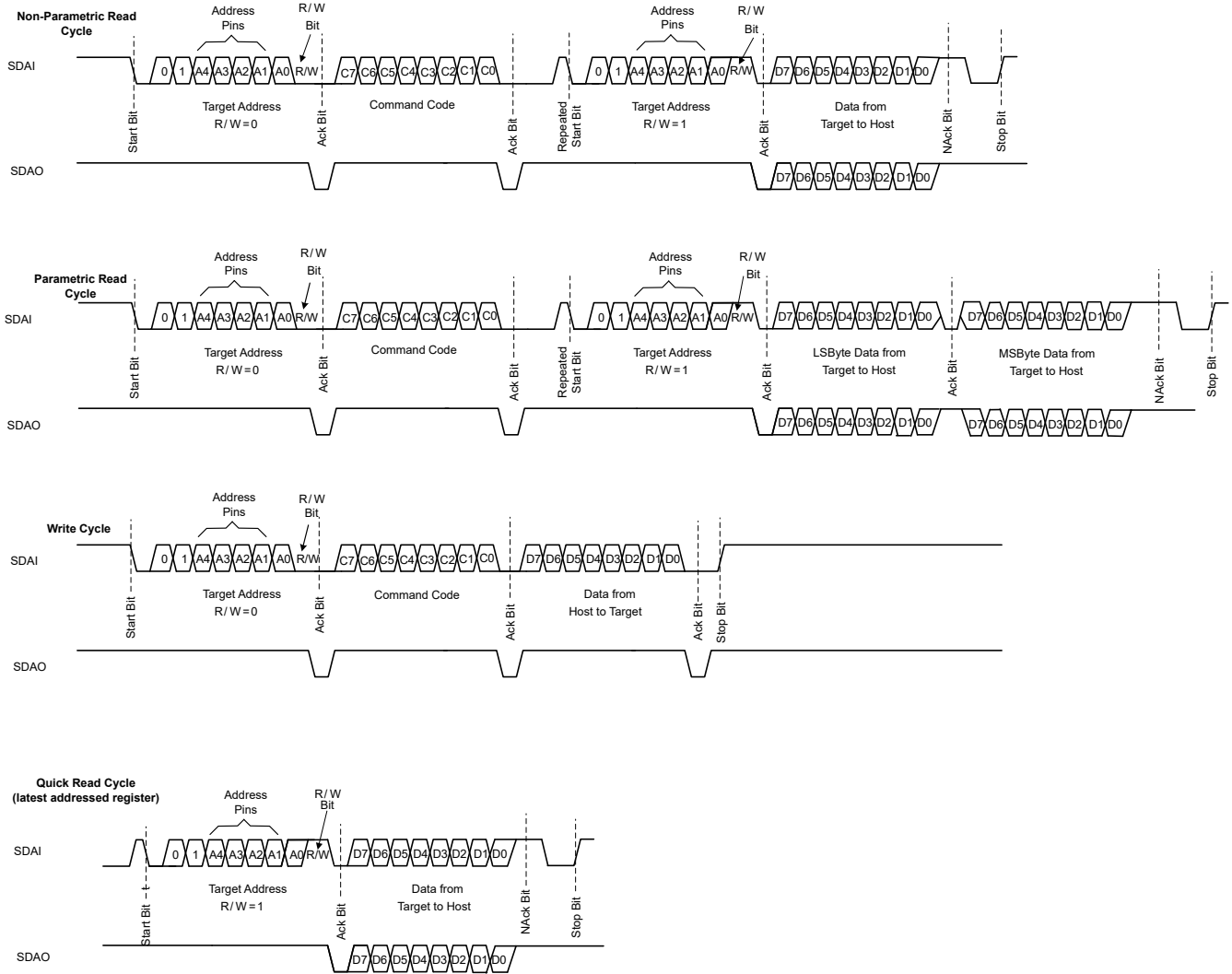

图 9-5. I²C interface Read and Write Protocol - Configuration B

9.6 Register Maps

9.6.1 Complete Register Set

表 9-3. Main Registers

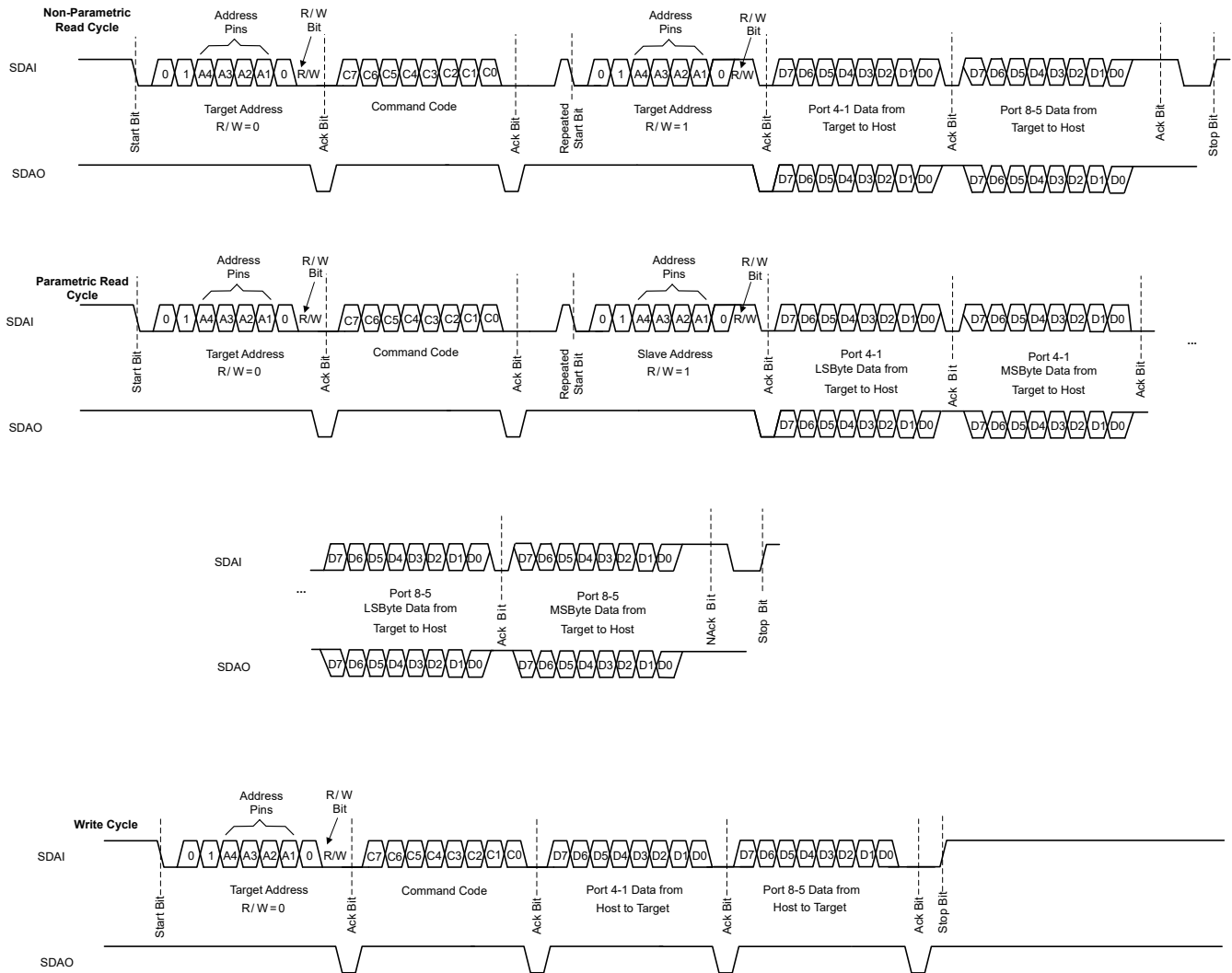
Cmd Code	Register or Command Name	I ² C R/W	Data Byte	RST State	Bits Description							
INTERRUPTS												
00h	INTERRUPT	RO	1	1000,0000b ⁽¹⁾	SUPF	STRTF	IFAULT	CLASC	DETC	DISF	PGC	PEC
01h	INTERRUPT MASK	R/W	1	1000,0000b	SUMSK	STMSK	IFMSK	CLMSK	DEMSK	DIMSK	PGMSK	PEMSK
EVENT												
02h	POWER EVENT	RO	1	0000,0000b	Power Good status change				Power Enable status change			
03h		CoR	1		PGC4	PGC3	PGC2	PGC1	PEC4	PEC3	PEC2	PEC1
04h	DETECTION EVENT	RO	1	0000,0000b	Classification				Detection			
05h		CoR	1		CLSC4	CLSC3	CLSC2	CLSC1	DETC4	DETC3	DETC2	DETC1
06h	FAULT EVENT	RO	1	0000,0000b	Disconnect occurred				PCUT fault occurred			
07h		CoR	1		DISF4	DISF3	DISF2	DISF1	PCUT4	PCUT3	PCUT2	PCUT1
08h	START/ILIM EVENT	RO	1	0000,0000b	ILIM fault occurred				START fault occurred			
09h		CoR	1		ILIM4	ILIM3	ILIM2	ILIM1	STRT4	STRT3	STRT2	STRT1
0Ah	SUPPLY/FAULT EVENT	RO	1	0111,0000b ⁽²⁾	TSD	VDUV	VDWRN	VPUV	Rsvrd	Rsvrd	OSSE	RAMFLT
0Bh		CoR	1									
STATUS												
0Ch	CHANNEL 1 DISCOVERY	RO	1	0000,0000b	Requested CLASS Channel 1				DETECT Channel 1			
0Dh	CHANNEL 2 DISCOVERY	RO	1	0000,0000b	Requested CLASS Channel 2				DETECT Channel 2			
0Eh	CHANNEL 3 DISCOVERY	RO	1	0000,0000b	Requested CLASS Channel 3				DETECT Channel 3			
0Fh	CHANNEL 4 DISCOVERY	RO	1	0000,0000b	Requested CLASS Channel 4				DETECT Channel 4			
10h	POWER STATUS	RO	1	0000,0000b	PG4	PG3	PG2	PG1	PE4	PE3	PE2	PE1
11h	PIN STATUS	RO	1	0,A[4:0],0,0	Rsvd	SLA4	SLA3	SLA2	SLA1	SLA0	Rsvd	Rsvd
CONFIGURATION												
12h	OPERATING MODE	R/W	1	0000,0000b	Channel 4 Mode		Channel 3 Mode		Channel 2 Mode		Channel 1 Mode	
13h	DISCONNECT ENABLE	R/W	1	0000,1111b	Rsvd	Rsvd	Rsvd	Rsvd	DCDE4	DCDE3	DCDE2	DCDE1
14h	DETECT/CLASS ENABLE	R/W	1	0000,0000b	CLE4	CLE3	CLE2	CLE1	DETE4	DETE3	DETE2	DETE1
15h	PWRPR/PCUT DISABLE	R/W	1	0000,0000b	OSS4	OSS3	OSS2	OSS1	DCUT4	DCUT3	DCUT2	DCUT1
16h	TIMING CONFIG	R/W	1	0000,0000b	TLIM		TSTART		TOVLD		TMPDO	
17h	GENERAL MASK	R/W	1	1000,0000b	INTEN	Rsvd	nbitACC	MbitPrtY	CLCHE	DECHE	Rsvd	

表 9-3. Main Registers (continued)

Cmd Code	Register or Command Name	I ² C R/W	Data Byte	RST State	Bits Description							
PUSH BUTTONS												
18h	DETECT/CLASS Restart	WO	1	0000,0000b	RCL4	RCL3	RCL2	RCL1	RDET4	RDET3	RDET2	RDET1
19h	POWER ENABLE	WO	1	0000,0000b	POFF4	POFF3	POFF2	POFF1	PWON4	PWON3	PWON2	PWON1
1Ah	RESET	WO	1	0000,0000b	CLRIN	CLINP	Rsvd	RESAL	RESP4	RESP3	RESP2	RESP1
GENERAL/SPECIALIZED												
1Bh	ID	RO	1	0101,0101b	MFR ID				IC Version			
1Ch	AUTOCLASS	R/O	1	0000,0000b	AC4	AC3	AC2	AC1	Rsvrd	Rsvrd	Rsvrd	Rsvrd
1Dh	RESERVED	R/W	1	0000,0000b	Rsvrd							
1Eh	2P POLICE 1 CONFIG	R/W	1	1111,1111b	2-Pair POLICE Channel 1							
1Fh	2P POLICE 2 CONFIG	R/W	1	1111,1111b	2-Pair POLICE Channel 2							
20h	2P POLICE 3 CONFIG	R/W	1	1111,1111b	2-Pair POLICE Channel 3							
21h	2P POLICE 4 CONFIG	R/W	1	1111,1111b	2-Pair POLICE Channel 4							
22h	CAP MEASUREMENT ⁽³⁾	R/W	1	0000,0000b	Rsvd	CDET4	Rsvd	CDET3	Rsvd	CDET2	Rsvd	CDET1
23h	Reserved	R/W	1	0000,0000b	Rsvd	Rsvd	Rsvd	Rsvd	Rsvd	Rsvd	Rsvd	Rsvd
24h	Power-on FAULT	RO	1	0000,0000b	PF Channel 4		PF Channel 3		PF Channel 2		PF Channel 1	
25h		CoR	1									
26h	RE-MAPPING	R/W	1	1110,0100b	Physical re-map Logical Port 4		Physical re-map Logical Port 3		Physical re-map Logical Port 2		Physical re-map Logical Port 1	
27h	Multi-Bit Priority 21	R/W	1	0000,0000b	Rsvd	Channel 2		Rsvd	Channel 1			
28h	Multi-Bit Priority 43	R/W	1	0000,0000b	Rsvd	Channel 4		Rsvd	Channel 3			
29h	Port Power Allocation	R/W	1	0000,0000b	Rsvd	MC34		Rsvd	MC12			
2A - 2Bh	Reserved	R/W	1	1111,1111b	Rsvrd							
2Ch	TEMPERATURE	RO	1	0000,0000b	Temperature (bits 7 to 0)							
2Dh	Reserved	R/W	1	0000,0000b	Rsvd	Rsvd	Rsvd	Rsvd	Rsvd	Rsvd	Rsvd	Rsvd
2Eh	INPUT VOLTAGE	RO	2	0000,0000b	Input Voltage: LSByte							
2Fh		RO		0000,0000b	Rsvd	Rsvd	Input Voltage: MSByte (bits 13 to 8)					
EXTENDED REGISTER SET - PARAMETRIC MEASUREMENT												
30h	Channel 1 CURRENT	RO	2	0000,0000b	Channel 1 Current: LSByte							
31h		RO		0000,0000b	Rsvd	Rsvd	Channel 1 Current: MSByte (bits 13 to 8)					
32h	Channel 1 VOLTAGE	RO	2	0000,0000b	Channel 1 Voltage: LSByte							
33h		RO		0000,0000b	Rsvd	Rsvd	Channel 1 Voltage: MSByte (bits 13 to 8)					

- (1) SUPF bit reset state shown is at Power up only
- (2) VDUV, VPUV and VDWRN bits reset state shown is at Power up only
- (3) Capacitance Measurement is only supported if SRAM code is programmed

表 9-4. Main Registers

Cmd Code	Register or Command Name	I ² C R/W	Data Byte	RST State	Bits Description							
34h	Channel 2 CURRENT	RO	2	0000,0000b	Channel 2 Current: LSByte							
35h		RO		0000,0000b	Rsvd	Rsvd	Channel 2 Current: MSByte (bits 13 to 8)					
36h	Channel 2 VOLTAGE	RO	2	0000,0000b	Channel 2 Voltage: LSByte							
37h		RO		0000,0000b	Rsvd	Rsvd	Channel 2 Voltage: MSByte (bits 13 to 8)					
38h	Channel 3 CURRENT	RO	2	0000,0000b	Channel 3 current: LSByte							
39h		RO		0000,0000b	Rsvd	Rsvd	Channel 3 Current: MSByte (bits 13 to 8)					
3Ah	Channel 3 VOLTAGE	RO	2	0000,0000b	Channel 3 Voltage: LSByte							
3Bh		RO		0000,0000b	Rsvd	Rsvd	Channel 3 Voltage: MSByte (bits 13 to 8)					
3Ch	Channel 4 CURRENT	RO	2	0000,0000b	Channel 4 current: LSByte							
3Dh		RO		0000,0000b	Rsvd	Rsvd	Channel 4 Current: MSByte (bits 13 to 8)					
3Eh	Channel 4 VOLTAGE	RO	2	0000,0000b	Channel 4 Voltage: LSByte							
3Fh		RO		0000,0000b	Rsvd	Rsvd	Channel 4 Voltage: MSByte (bits 13 to 8)					
CONFIGURATION/OTHERS												
40h	CHANNEL FOLDBACK	R/W	1	0000,0000b	2xFB4	2xFB3	2xFB2	2xFB1	MPOL4	MPOL3	MPOL2	MPOL1
41h	FIRMWARE REVISION	RO	1	RRRR,RRRRb	Firmware Revision							
42h	I2C WATCHDOG	R/W	1	0001,0110b	Rsvd	Rsvd	Rsvd	Watchdog Disable				WDS
43h	DEVICE ID	RO	1	0011,0100b	Device ID number				Silicon Revision number			
SIGNATURE MEASUREMENTS												
44h	Ch1 DETECT RESISTANCE	RO	1	0000,0000b	Channel 1 Resistance							
45h	Ch2 DETECT RESISTANCE	RO	1	0000,0000b	Channel 2 Resistance							
46h	Ch3 DETECT RESISTANCE	RO	1	0000,0000b	Channel 3 Resistance							
47h	Ch4 DETECT RESISTANCE	RO	1	0000,0000b	Channel 4 Resistance							
48h	Ch1 CAP MEASUREMENT ⁽³⁾	RO	1	0000,0000b	Channel 1 Capacitance							
49h	Ch2 CAP MEASUREMENT ⁽³⁾	RO	1	0000,0000b	Channel 2 Capacitance							
4Ah	Ch3 CAP MEASUREMENT ⁽³⁾	RO	1	0000,0000b	Channel 3 Capacitance							
4Bh	Ch4 CAP MEASUREMENT ⁽³⁾	RO	1	0000,0000b	Channel 4 Capacitance							

表 9-4. Main Registers (continued)

Cmd Code	Register or Command Name	I ² C R/W	Data Byte	RST State	Bits Description							
ASSIGNED CHANNEL STATUS												
4Ch	ASSIGNED CLASS CHANNEL 1	RO	1	0000,0000b	Assigned CLASS Channel 1				Previous CLASS Channel 1			
4Dh	ASSIGNED CLASS CHANNEL 2	RO	1	0000,0000b	Assigned CLASS Channel 2				Previous CLASS Channel 2			
4Eh	ASSIGNED CLASS CHANNEL 3	RO	1	0000,0000b	Assigned CLASS Channel 3				Previous CLASS Channel 3			
4Fh	ASSIGNED CLASS CHANNEL 4	RO	1	0000,0000b	Assigned CLASS Channel 4				Previous CLASS Channel 4			
AUTOCLASS CONFIGURATION/MEASUREMENTS												
50h	AUTOCLASS CONTROL	R/W	1	0000,0000b	MAC4	MAC3	MAC2	MAC1	AAC4	AAC3	AAC2	AAC1
51h	CHANNEL 1 AUTOCLASS PWR	RO	1	0000,0000b	Rsvd	Channel 1 AutoClass Power						
52h	CHANNEL 2 AUTOCLASS PWR	RO	1	0000,0000b	Rsvd	Channel 2 AutoClass Power						
53h	CHANNEL 3 AUTOCLASS PWR	RO	1	0000,0000b	Rsvd	Channel 3 AutoClass Power						
54h	CHANNEL 4 AUTOCLASS PWR	RO	1	0000,0000b	Rsvd	Channel 4 AutoClass Power						
MISCELLANEOUS												
55h	ALTERNATIVE FOLDBACK	R/W	1	0000,0000b	ALTFB4	ALTFB3	ALTFB ₂	ALTFB1	ALTIR4	ALTIR3	ALTIR2	ALTIR1
56h - 5Fh	RESERVED	R/W	1	0000,0000b	Rsvd	Rsvd	Rsvd	Rsvd	Rsvd	Rsvd	Rsvd	Rsvd
SRAM												
60h	SRAM CONTROL	R/W	1	0000,0000b	PROG_SEL	CPU_RST	Rsvd	PAR_EN	RAM_EN	PAR_SEL	RZ/W	CLR_PTR
61h	SRAM DATA	R/W	-	-	SRAM DATA - Read and Write (continuous)							
62h	START ADDRESS	R/W	1	0000,0000b	Programming Start Address (LSB)							
63h		R/W	1	0000,0000b	Programming Start Address (MSB)							
64h - 6Fh	RESERVED	R/W	1	0000,0000b	Rsvd	Rsvd	Rsvd	Rsvd	Rsvd	Rsvd	Rsvd	Rsvd

9.6.2 Detailed Register Descriptions

9.6.2.1 INTERRUPT Register

COMMAND = 00h with 1 Data Byte, Read only

Active high, each bit corresponds to a particular event that occurred. Each bit can be individually reset by doing a read at the corresponding event register address, or by setting bit 7 of Reset register.

Any active bit of Interrupt register activates the \overline{INT} output if its corresponding Mask bit in INTERRUPT Mask register (01h) is set, as well as the INTEN bit in the General Mask register.

图 9-6. INTERRUPT Register Format

7	6	5	4	3	2	1	0
SUPF	STRTF	IFAULT	CLASC	DETC	DISF	PGC	PEC
R-1	R-0	R-0	R-0	R-0	R-0	R-0	R-0

LEGEND: R/W = Read/Write; R = Read only; -n = value after reset

表 9-5. INTERRUPT Register Field Descriptions

Bit	Field	Type	Reset	Description
7	SUPF	R	1	Indicates that a Supply Event Fault or SRAM memory fault occurred SUPF = TSD VDUV VDWRN VPUV RAMFLT 1 = At least one Supply Event Fault or SRAM memory fault occurred 0 = No such event occurred
6	STRTF	R	0	Indicates that a t_{START} Fault occurred on at least one channel. STRTF = STRT1 STRT2 STRT3 STRT4 1 = t_{START} Fault occurred for at least one channel 0 = No t_{START} Fault occurred
5	IFAULT	R	0	Indicates that a $t_{OVL D}$ or t_{LIM} Fault occurred on at least one channel. IFAULT = PCUT1 PCUT2 PCUT3 PCUT4 ILIM1 ILIM2 ILIM3 ILIM4 1 = $t_{OVL D}$ and/or t_{LIM} Fault occurred for at least one channel 0 = No $t_{OVL D}$ nor t_{LIM} Fault occurred
4	CLASC	R	0	Indicates that at least one classification cycle occurred on at least one channel CLASC = CLSC1 CLSC2 CLSC3 CLSC4 1 = At least one classification cycle occurred for at least one channel 0 = No classification cycle occurred
3	DETC	R	0	Indicates that at least one detection cycle occurred on at least one channel DETC = DETC1 DETC2 DETC3 DETC4 1 = At least one detection cycle occurred for at least one channel 0 = No detection cycle occurred
2	DISF	R	0	Indicates that a disconnect event occurred on at least one channel. DISF = DISF1 DISF2 DISF3 DISF4 1 = Disconnect event occurred for at least one channel 0 = No disconnect event occurred
1	PGC	R	0	Indicates that a power good status change occurred on at least one channel. PGC = PGC1 PGC2 PGC3 PGC4 1 = Power good status change occurred on at least one channel 0 = No power good status change occurred

表 9-5. INTERRUPT Register Field Descriptions (continued)

Bit	Field	Type	Reset	Description
0	PEC	R	0	<p>Indicates that a power enable status change occurred on at least one channel PEC = PEC1 PEC2 PEC3 PEC4</p> <p>1 = Power enable status change occurred on at least one channel 0 = No power enable status change occurred</p>

9.6.2.2 INTERRUPT MASK Register

COMMAND = 01h with 1 Data Byte, Read/Write

Each bit corresponds to a particular event or fault as defined in the Interrupt register.

Writing a 0 into a bit will mask the corresponding event/fault from activating the $\overline{\text{INT}}$ output.

Note that the bits of the Interrupt register always change state according to events or faults, regardless of the state of the state of the Interrupt Mask register.

Note that the INTEN bit of the General Mask register must also be set in order to allow an event to activate the $\overline{\text{INT}}$ output.

图 9-7. INTERRUPT MASK Register Format

7	6	5	4	3	2	1	0
SUMSK	STMSK	IFMSK	CLMSK	DEMSK	DIMSK	PGMSK	PEMSK
R/W-1	R/W-0	R/W-0	R/W-0	R/W-0	R/W-0	R/W-0	R/W-0

LEGEND: R/W = Read/Write; R = Read only; -n = value after reset

表 9-6. INTERRUPT MASK Register Field Descriptions

Bit	Field	Type	Reset	Description
7	SUMSK	R/W	1	Supply Event Fault mask bit. 1 = Supply Event Fault will activate the $\overline{\text{INT}}$ output. 0 = Supply Event Fault will have no impact on $\overline{\text{INT}}$ output.
6	STMSK	R/W	0	t_{START} Fault mask bit. 1 = t_{START} Fault will activate the $\overline{\text{INT}}$ output. 0 = t_{START} Fault will have no impact on $\overline{\text{INT}}$ output.
5	IFMSK	R/W	0	$t_{\text{OVL D}}$ or t_{LIM} Fault mask bit. 1 = $t_{\text{OVL D}}$ and/or t_{LIM} Fault occurrence will activate the $\overline{\text{INT}}$ output 0 = $t_{\text{OVL D}}$ and/or t_{LIM} Fault occurrence will have no impact on $\overline{\text{INT}}$ output
4	CLMSK	R/W	0	Classification cycle mask bit. 1 = Classification cycle occurrence will activate the $\overline{\text{INT}}$ output. 0 = Classification cycle occurrence will have no impact on $\overline{\text{INT}}$ output.
3	DEMSK	R/W	0	Detection cycle mask bit. 1 = Detection cycle occurrence will activate the $\overline{\text{INT}}$ output. 0 = Detection cycle occurrence will have no impact on $\overline{\text{INT}}$ output.
2	DIMSK	R/W	0	Disconnect event mask bit. 1 = Disconnect event occurrence will activate th $\overline{\text{INT}}$ output. 0 = Disconnect event occurrence will have no impact on $\overline{\text{INT}}$ output.
1	PGMSK	R/W	0	Power good status change mask bit. 1 = Power good status change will activate the $\overline{\text{INT}}$ output. 0 = Power good status change will have no impact on $\overline{\text{INT}}$ output.
0	PEMSK	R/W	0	Power enable status change mask bit. 1 = Power enable status change will activate the $\overline{\text{INT}}$ output. 0 = Power enable status change will have no impact on $\overline{\text{INT}}$ output.

9.6.2.3 POWER EVENT Register

COMMAND = 02h with 1 Data Byte, Read only

COMMAND = 03h with 1 Data Byte, Clear on Read

Active high, each bit corresponds to a particular event that occurred.

Each bit xxx1-4 represents an individual channel.

A read at each location (02h or 03h) returns the same register data with the exception that the Clear on Read command clears all bits of the register.

If this register is causing the $\overline{\text{INT}}$ pin to be activated, this Clear on Read will release the $\overline{\text{INT}}$ pin.

Any active bit will have an impact on the Interrupt register as indicated in the Interrupt register description.

图 9-8. POWER EVENT Register Format

7	6	5	4	3	2	1	0
PGC4	PGC3	PGC2	PGC1	PEC4	PEC3	PEC2	PEC1
R-0	R-0	R-0	R-0	R-0	R-0	R-0	R-0
CR-0	CR-0	CR-0	CR-0	CR-0	CR-0	CR-0	CR-0

LEGEND: R/W = Read/Write; R = Read only; ; CR = Clear on Read, -n = value after reset

表 9-7. POWER EVENT Register Field Descriptions

Bit	Field	Type	Reset	Description
7 - 4	PGC4 - PGC1	R or CR	0	Indicates that a power good status change occurred. 1 = Power good status change occurred 0 = No power good status change occurred
3 - 0	PEC4 - PEC1	R or CR	0	Indicates that a power enable status change occurred. 1 = Power enable status change occurred 0 = No power enable status change occurred

9.6.2.4 DETECTION EVENT Register

COMMAND = 04h with 1 Data Byte, Read only

COMMAND = 05h with 1 Data Byte, Clear on Read

Active high, each bit corresponds to a particular event that occurred.

Each bit xxx1-4 represents an individual channel.

A read at each location (04h or 05h) returns the same register data with the exception that the Clear on Read command clears all bits of the register. These bits are cleared when channel-n is turned off.

If this register is causing the $\overline{\text{INT}}$ pin to be activated, this Clear on Read will release the $\overline{\text{INT}}$ pin.

Any active bit will have an impact on the Interrupt register as indicated in the Interrupt register description.

图 9-9. DETECTION EVENT Register Format

7	6	5	4	3	2	1	0
CLSC4	CLSC3	CLSC2	CLSC1	DETC4	DETC3	DETC2	DETC1
R-0	R-0	R-0	R-0	R-0	R-0	R-0	R-0
CR-0	CR-0	CR-0	CR-0	CR-0	CR-0	CR-0	CR-0

LEGEND: R/W = Read/Write; R = Read only; ; CR = Clear on Read, -n = value after reset

表 9-8. DETECTION EVENT Register Field Descriptions

Bit	Field	Type	Reset	Description
7 - 4	CLSC4 - CLSC1	R or CR	0	Indicates that at least one classification cycle occurred if the CLCHE bit in General Mask register is low. Conversely, it indicates when a change of class occurred if the CLCHE bit is set. 1 = At least one classification cycle occurred (if CLCHE = 0) or a change of class occurred (CLCHE = 1) 0 = No classification cycle occurred (if CLCHE = 0) or no change of class occurred (CLCHE = 1)
3 - 0	DETC4 - DETC1	R or CR	0	Indicates that at least one detection cycle occurred if the DECHE bit in General Mask register is low. Conversely, it indicates when a change in detection occurred if the DECHE bit is set. 1 = At least one detection cycle occurred (if DECHE = 0) or a change in detection occurred (DECHE = 1) 0 = No detection cycle occurred (if DECHE = 0) or no change in detection occurred (DECHE = 1)

9.6.2.5 FAULT EVENT Register

COMMAND = 06h with 1 Data Byte, Read only

COMMAND = 07h with 1 Data Byte, Clear on Read

Active high, each bit corresponds to a particular event that occurred.

Each bit xxx1-4 represents an individual channel.

A read at each location (06h or 07h) returns the same register data with the exception that the Clear on Read command clears all bits of the register. These bits are cleared when channel-n is turned off.

If this register is causing the $\overline{\text{INT}}$ pin to be activated, this Clear on Read will release the $\overline{\text{INT}}$ pin.

Any active bit will have an impact on the Interrupt register as indicated in the Interrupt register description.

图 9-10. FAULT EVENT Register Format

7	6	5	4	3	2	1	0
DISF4	DISF3	DISF2	DISF1	PCUT4	PCUT3	PCUT2	PCUT1
R-0	R-0	R-0	R-0	R-0	R-0	R-0	R-0
CR-0	CR-0	CR-0	CR-0	CR-0	CR-0	CR-0	CR-0

LEGEND: R/W = Read/Write; R = Read only; ; CR = Clear on Read, -n = value after reset

表 9-9. FAULT EVENT Register Field Descriptions

Bit	Field	Type	Reset	Description
7 - 4	DISF4 - DISF1	R or CR	0	Indicates that a disconnect event occurred. 1 = Disconnect event occurred 0 = No disconnect event occurred
3 - 0	PCUT4 - PCUT1	R or CR	0	Indicates that a $t_{\text{OVL D}}$ Fault occurred. 1 = $t_{\text{OVL D}}$ Fault occurred 0 = No $t_{\text{OVL D}}$ Fault occurred

Clearing a PCUT event has no impact on the TLIM or TOVLD counters.

9.6.2.6 START/ILIM EVENT Register

COMMAND = 08h with 1 Data Byte, Read only

COMMAND = 09h with 1 Data Byte, Clear on Read

Active high, each bit corresponds to a particular event that occurred.

Each bit xxx1-4 represents an individual channel.

A read at each location (08h or 09h) returns the same register data with the exception that the Clear on Read command clears all bits of the register. These bits are cleared when channel-n is turned off.

If this register is causing the $\overline{\text{INT}}$ pin to be activated, this Clear on Read will release the $\overline{\text{INT}}$ pin.

Any active bit will have an impact on the Interrupt register as indicated in the Interrupt register description.

图 9-11. START/ILIM EVENT Register Format

7	6	5	4	3	2	1	0
ILIM4	ILIM3	ILIM2	ILIM1	STRT4	STRT3	STRT2	STRT1
R-0	R-0	R-0	R-0	R-0	R-0	R-0	R-0
CR-0	CR-0	CR-0	CR-0	CR-0	CR-0	CR-0	CR-0

LEGEND: R/W = Read/Write; R = Read only; ; CR = Clear on Read, -n = value after reset

表 9-10. START/ILIM EVENT Register Field Descriptions

Bit	Field	Type	Reset	Description
7 - 4	ILIM4 - ILIM1	R or CR	0	Indicates that a t_{LIM} fault occurred, which means the channel has limited its output current to I_{LIM} or the folded back I_{LIM} for more than t_{LIM} . 1 = t_{LIM} fault occurred 0 = No t_{LIM} fault occurred
3 - 0	STRT4 - STRT1	R or CR	0	Indicates that a t_{START} fault occurred during turn on. 1 = t_{START} fault or class/detect error occurred 0 = No t_{START} fault or class/detect error occurred

备注

When a Start Fault is reported and the PECn bit in Power Event register is set, then there is an Inrush fault.

When a Start Fault is reported and the PECn bit is **not** set, then the Power-On Fault register (0x24h) will indicate the cause of the fault.

In auto mode, STRTn faults will not be reported and register 0x24h will not be updated due to invalid discovery results.

9.6.2.7 SUPPLY and FAULT EVENT Register

COMMAND = 0Ah with 1 Data Byte, Read only

COMMAND = 0Bh with 1 Data Byte, Clear on Read

Active high, each bit corresponds to a particular event that occurred.

A read at each location (0Ah or 0Bh) returns the same register data with the exception that the Clear on Read command clears all bits of the register.

If this register is causing the $\overline{\text{INT}}$ pin to be activated, this Clear on Read will release the $\overline{\text{INT}}$ pin.

Any active bit will have an impact on the Interrupt register as indicated in the Interrupt register description.

图 9-12. SUPPLY and FAULT EVENT Register Format

7	6	5	4	3	2	1	0
TSD	VDUV	VDWRN	VPUV	Rsvrd	Rsvrd	OSSE	RAMFLT
R	R	R	R	R	R	R	R
CR	CR	CR	CR	CR	CR	CR	CR

LEGEND: R/W = Read/Write; R = Read only; ; CR = Clear on Read, -n = value after reset

表 9-11. SUPPLY and FAULT EVENT Register Field Descriptions

Bit	Field	Type	POR/ ST	Description
7	TSD	R or CR	0 / P	Indicates that a thermal shutdown occurred. When there is thermal shutdown, all channels are turned off and are put in OFF mode. The internal circuitry continues to operate however, including the ADCs. Note that at as soon as the internal temperature has decreased below the low threshold, the channels can be turned back ON regardless of the status of the TSD bit. 1 = Thermal shutdown occurred 0 = No thermal shutdown occurred
6	VDUV	R or CR	1 / P	Indicates that a VDD UVLO occurred. 1 = VDD UVLO occurred 0 = No VDD UVLO occurred
5	VDWRN	R or CR	1 / P	Indicates that the VDD has fallen under the UVLO warning threshold. 1 = VDD UV Warning occurred 0 = No VDD UV warning occurred
4	VPUV	R or CR	1 / P	Indicates that a VPWR undervoltage occurred. 1 = VPWR undervoltage occurred 0 = No VPWR undervoltage occurred
3-2	Rsvrd	R or CR	0 / 0	Reserved
1	OSSE	R or CR	0 / 0	Indicates that an OSS Event occurred 1 = one or more channels with a group of 4 were disabled due to the assertion of the OSS pin or provided 3-bit OSS code 0 = No OSS events occurred
0	RAMFLT	R or CR	0 / 0	Indicates that a SRAM fault has occurred 1 = SRAM fault occurred 0 = No SRAM fault occurred

备注

The RST condition of "P" indicates that the previous state of these bits will be preserved following a device reset using the $\overline{\text{RESET}}$ pin. Thus, pulling the $\overline{\text{RESET}}$ input low will not clear the TSD, VDUV, VDWRN, or VPUV bits.

备注

While the VPUV bit is set, any PWONn commands will be ignored until $V_{\text{VPWR}} > 30 \text{ V}$.

During VPUV undervoltage condition, the Detection Event register (CLSCn, DETCn) is not cleared, unless VPWR also falls below the VPWR UVLO falling threshold (approximately 18 V).

A clear on Read will not effectively clear VDUV bit as long as the VPWR undervoltage condition is maintained.

备注

In 1-bit mode (MbitPrty = 0 in reg 0x17), the OSSE bit will be set anytime a channel within a group of 4 has OSS enabled and the OSS pin is asserted.

In 3-bit mode (MbitPrty = 1 in reg 0x17), the OSSE bit will be set anytime a 3-bit priority code is sent that is equal to or greater than the MBPn settings in registers 0x27 and 0x28 channel for a group of 4 channels.

9.6.2.7.1 Detected SRAM Faults and "Safe Mode"

The TPS23882B is configured with internal SRAM memory fault monitoring, and in the event that an error is detected with the SRAM memory, the device will enter "safe mode". While in "Safe mode" the FW Revision value in register 0x41 will be set to 0xFFh.

Any channels that are currently powered will remain powered, but the majority of the operation will be disabled until the SRAM can be reloaded. The device UVLO and Thermal Shutdown features in addition to the disconnect and current foldback functions for the powered channels will be preserved in "safe mode".

Any channels that were not powered prior to the SRAM fault detection will be set to OFF mode (see register 0x12h description for additional changes that will occur as a result of the change to OFF mode). Port Remapping (0x26h) and any other channel configuration settings (ie Power Allocation 0x29h) will be preserved.

Upon detection of a SRAM fault the "RAM_EN" bit in 0x60 will be cleared and the RAMFLT bit will be set in register 0x0A. The internal firmware will continue to run in "safe mode" until this bit is set again by the host after the SRAM is reloaded or a POR (Power on Reset) event occurs. In order to ensure a smooth transition into and out of "safe mode", any I2C commands other than those to reprogram the SRAM need to be deferred until after the SRAM is reloaded and determined to be "valid" (see register 0x60 SRAM programming descriptions).

备注

Once set, the RAMFLT bit will remain set even after the device is removed from safe mode. it is recommend that this bit be cleared prior to setting the RAM_EN bit in register 0x60 following the SRAM reload.

备注

The PAR_EN bit in reg 0x60 must be set and the corresponding SRAM_Parity code (available for download from the [TI mySecure Software](#) webpage) must be loaded into the device in order for the SRAM fault monitoring to be active.

Please refer to the [How to Load TPS2388x SRAM Code](#) document for more information on the recommended SRAM programming procedure.

9.6.2.8 CHANNEL 1 DISCOVERY Register

COMMAND = 0Ch with 1 Data Byte, Read Only

图 9-13. CHANNEL 1 DISCOVERY Register Format

7	6	5	4	3	2	1	0
REQUESTED CLASS Ch1				DETECT Ch1			
R-0	R-0	R-0	R-0	R-0	R-0	R-0	R-0

LEGEND: R/W = Read/Write; R = Read only; -n = value after reset

9.6.2.9 CHANNEL 2 DISCOVERY Register

COMMAND = 0Dh with 1 Data Byte, Read Only

图 9-14. CHANNEL 2 DISCOVERY Register Format

7	6	5	4	3	2	1	0
REQUESTED CLASS Ch2				DETECT Ch2			
R-0	R-0	R-0	R-0	R-0	R-0	R-0	R-0

LEGEND: R/W = Read/Write; R = Read only; -n = value after reset

9.6.2.10 CHANNEL 3 DISCOVERY Register

COMMAND = 0Eh with 1 Data Byte, Read Only

图 9-15. CHANNEL 3 DISCOVERY Register Format

7	6	5	4	3	2	1	0
REQUESTED CLASS Ch3				DETECT Ch3			
R-0	R-0	R-0	R-0	R-0	R-0	R-0	R-0

LEGEND: R/W = Read/Write; R = Read only; -n = value after reset

9.6.2.11 CHANNEL 4 DISCOVERY Register

COMMAND = 0Fh with 1 Data Byte, Read Only

图 9-16. CHANNEL 4 DISCOVERY Register Format

7	6	5	4	3	2	1	0
REQUESTED CLASS Ch4				DETECT Ch4			
R-0	R-0	R-0	R-0	R-0	R-0	R-0	R-0

LEGEND: R/W = Read/Write; R = Read only; -n = value after reset

Bit Descriptions: These bits represent the most recent **"requested"** classification and detection results for channel n. These bits are cleared when channel n is turned off.

表 9-12. CHANNEL n DISCOVERY Register Field Descriptions

Bit	Field	Type	Reset	Description																																																																																					
7 - 4	RCLASS Ch-n	R	0	Most recent classification result on channel n. The selection is as following: <table border="1" style="margin-left: 20px;"> <thead> <tr> <th colspan="4">RCLASS Ch-n</th> <th>Requested Class</th> </tr> </thead> <tbody> <tr><td>0</td><td>0</td><td>0</td><td>0</td><td>Unknown</td></tr> <tr><td>0</td><td>0</td><td>0</td><td>1</td><td>Class 1</td></tr> <tr><td>0</td><td>0</td><td>1</td><td>0</td><td>Class 2</td></tr> <tr><td>0</td><td>0</td><td>1</td><td>1</td><td>Class 3</td></tr> <tr><td>0</td><td>1</td><td>0</td><td>0</td><td>Class 4</td></tr> <tr><td>0</td><td>1</td><td>0</td><td>1</td><td>Reserved - read as Class 0</td></tr> <tr><td>0</td><td>1</td><td>1</td><td>0</td><td>Class 0</td></tr> <tr><td>0</td><td>1</td><td>1</td><td>1</td><td>Class Overcurrent</td></tr> <tr><td>1</td><td>0</td><td>0</td><td>0</td><td>Class 5 - 4-Pair Single Signature</td></tr> <tr><td>1</td><td>0</td><td>0</td><td>1</td><td>Class 6 - 4-Pair Single Signature</td></tr> <tr><td>1</td><td>0</td><td>1</td><td>0</td><td>Class 7 - 4-Pair Single Signature</td></tr> <tr><td>1</td><td>0</td><td>1</td><td>1</td><td>Class 8 - 4-Pair Single Signature</td></tr> <tr><td>1</td><td>1</td><td>0</td><td>0</td><td>Class 4+ - Type-1 Limited</td></tr> <tr><td>1</td><td>1</td><td>0</td><td>1</td><td>Class 5 - 4-Pair Dual Signature</td></tr> <tr><td>1</td><td>1</td><td>1</td><td>0</td><td>Reserved</td></tr> <tr><td>1</td><td>1</td><td>1</td><td>1</td><td>Class Mismatch</td></tr> </tbody> </table>	RCLASS Ch-n				Requested Class	0	0	0	0	Unknown	0	0	0	1	Class 1	0	0	1	0	Class 2	0	0	1	1	Class 3	0	1	0	0	Class 4	0	1	0	1	Reserved - read as Class 0	0	1	1	0	Class 0	0	1	1	1	Class Overcurrent	1	0	0	0	Class 5 - 4-Pair Single Signature	1	0	0	1	Class 6 - 4-Pair Single Signature	1	0	1	0	Class 7 - 4-Pair Single Signature	1	0	1	1	Class 8 - 4-Pair Single Signature	1	1	0	0	Class 4+ - Type-1 Limited	1	1	0	1	Class 5 - 4-Pair Dual Signature	1	1	1	0	Reserved	1	1	1	1	Class Mismatch
RCLASS Ch-n				Requested Class																																																																																					
0	0	0	0	Unknown																																																																																					
0	0	0	1	Class 1																																																																																					
0	0	1	0	Class 2																																																																																					
0	0	1	1	Class 3																																																																																					
0	1	0	0	Class 4																																																																																					
0	1	0	1	Reserved - read as Class 0																																																																																					
0	1	1	0	Class 0																																																																																					
0	1	1	1	Class Overcurrent																																																																																					
1	0	0	0	Class 5 - 4-Pair Single Signature																																																																																					
1	0	0	1	Class 6 - 4-Pair Single Signature																																																																																					
1	0	1	0	Class 7 - 4-Pair Single Signature																																																																																					
1	0	1	1	Class 8 - 4-Pair Single Signature																																																																																					
1	1	0	0	Class 4+ - Type-1 Limited																																																																																					
1	1	0	1	Class 5 - 4-Pair Dual Signature																																																																																					
1	1	1	0	Reserved																																																																																					
1	1	1	1	Class Mismatch																																																																																					
3 - 0	DETECT Ch-n	R	0	Most recent detection result on channel n. The selection is as following: <table border="1" style="margin-left: 20px;"> <thead> <tr> <th colspan="4">DETECT Ch-n</th> <th>Detection Status</th> </tr> </thead> <tbody> <tr><td>0</td><td>0</td><td>0</td><td>0</td><td>Unknown</td></tr> <tr><td>0</td><td>0</td><td>0</td><td>1</td><td>Short-circuit</td></tr> <tr><td>0</td><td>0</td><td>1</td><td>0</td><td>Reserved</td></tr> <tr><td>0</td><td>0</td><td>1</td><td>1</td><td>Too Low</td></tr> <tr><td>0</td><td>1</td><td>0</td><td>0</td><td>Valid</td></tr> <tr><td>0</td><td>1</td><td>0</td><td>1</td><td>Too High</td></tr> <tr><td>0</td><td>1</td><td>1</td><td>0</td><td>Open Circuit</td></tr> <tr><td>0</td><td>1</td><td>1</td><td>1</td><td>Reserved</td></tr> <tr><td>1</td><td>1</td><td>1</td><td>0</td><td>MOSFET fault</td></tr> </tbody> </table>	DETECT Ch-n				Detection Status	0	0	0	0	Unknown	0	0	0	1	Short-circuit	0	0	1	0	Reserved	0	0	1	1	Too Low	0	1	0	0	Valid	0	1	0	1	Too High	0	1	1	0	Open Circuit	0	1	1	1	Reserved	1	1	1	0	MOSFET fault																																			
DETECT Ch-n				Detection Status																																																																																					
0	0	0	0	Unknown																																																																																					
0	0	0	1	Short-circuit																																																																																					
0	0	1	0	Reserved																																																																																					
0	0	1	1	Too Low																																																																																					
0	1	0	0	Valid																																																																																					
0	1	0	1	Too High																																																																																					
0	1	1	0	Open Circuit																																																																																					
0	1	1	1	Reserved																																																																																					
1	1	1	0	MOSFET fault																																																																																					

“Requested” vs. “Assigned” Classification: The “requested” class is the classification the PSE measures during Mutual Identification prior to turn on, whereas the “assigned” class is the classification level the channel was powered on with based on the Power Allocation setting in register 0x29h. The “assigned” classification values are available in registers 0x4C-4F

备注

Due to the need to power on after 1 class finger, the "Class 4+ - Type 1 Limited" Requested Class is reported anytime a Class 4 or higher PD is powered with register 0x29 configured for 15.5W.

Upon being powered, devices that present a class 0 signature during discovery will be given an assigned class of "Class 3"

Even though the TPS23882B is a 2-pair PSE controller, due to the use of 3-finger classification, it is still capable of identifying if a Class 5+ 4-pair PDs is connected.

9.6.2.12 POWER STATUS Register

COMMAND = 10h with 1 Data Byte, Read only

Each bit represents the actual power status of a channel.

Each bit xx1-4 represents an individual channel.

These bits are cleared when channel-n is turned off, including if the turn off is caused by a fault condition.

图 9-17. POWER STATUS Register Format

7	6	5	4	3	2	1	0
PG4	PG3	PG2	PG1	PE4	PE3	PE2	PE1
R-0	R-0	R-0	R-0	R-0	R-0	R-0	R-0

LEGEND: R/W = Read/Write; R = Read only; -n = value after reset

表 9-13. POWER STATUS Register Field Descriptions

Bit	Field	Type	Reset	Description
7 - 4	PG4 - PG1	R	0	Each bit, when at 1, indicates that the channel is on and that the voltage at DRAINn pin has gone below the power good threshold during turn on. These bits are latched high once the turn on is complete and can only be cleared when the channel is turned off or at RESET/POR. 1 = Power is good 0 = Power is not good
3 - 0	PE4 - PE1	R	0	Each bit indicates the ON/OFF state of the corresponding channel. 1 = Channel is on 0 = Channel is off

9.6.2.13 PIN STATUS Register

COMMAND = 11h with 1 Data Byte, Read Only

图 9-18. PIN STATUS Register Format

7	6	5	4	3	2	1	0
0	SLA4	SLA3	SLA2	SLA1	SLA0	0	0
0	A4 pin	A3 pin	A2 pin	A1 pin	0/1 ⁽¹⁾	0	0

LEGEND: R/W = Read/Write; R = Read only; -n = value after reset

(1) If Configuration A, it can be 0 or 1. If configuration B, it is 0.

表 9-14. PIN STATUS Register Field Descriptions

Bit	Field	Type	Reset	Description
6-3	SLA4-SLA1	R	See above	I ² C device address, as defined while using pins A4-A1.
2	SLA0	R		SLA0 bit is internally defined to 0 or 1 0 = Channel 1-4 1 = Channels 5-8
7, 1-0	-	R		Reserved

DESCRIPTION	BINARY DEVICE ADDRESS							ADDRESS PINS			
	6	5	4	3	2	1	0	A4	A3	A2	A1
Broadcast access	1	1	1	1	1	1	1	X	X	X	X
Target 0	0	1	0	0	0	0	0/1	GND	GND	GND	GND
	0	1	0	0	0	1	0/1	GND	GND	GND	HIGH
	0	1	0	0	1	0	0/1	GND	GND	HIGH	GND
	0	1	0	0	1	1	0/1	GND	GND	HIGH	HIGH
	0	1	0	1	0	0	0/1	GND	HIGH	GND	GND
	0	1	0	1	0	1	0/1	GND	HIGH	GND	HIGH
	0	1	0	1	1	0	0/1	GND	HIGH	HIGH	GND
	0	1	0	1	1	1	0/1	GND	HIGH	HIGH	HIGH
	0	1	1	0	0	0	0/1	HIGH	GND	GND	GND
	0	1	1	0	0	1	0/1	HIGH	GND	GND	HIGH
	0	1	1	0	1	1	0/1	HIGH	GND	HIGH	HIGH
	0	1	1	1	0	0	0/1	HIGH	HIGH	GND	GND
	0	1	1	1	0	1	0/1	HIGH	HIGH	GND	HIGH
	0	1	1	1	1	0	0/1	HIGH	HIGH	HIGH	GND
Target 15	0	1	1	1	1	1	0/1	HIGH	HIGH	HIGH	HIGH

9.6.2.13.1 AUTONOMOUS MODE

In autonomous mode, the TPS23882B is capable of operating without any I²C communication or host control. As in auto mode, when the device is operating in autonomous mode, the ports will be continuously cycling through discovery, and the ports will automatically power whenever a valid (defection and classification) PD is connected.

Connecting a resistor between the AUTO pin and GND based on the table below [表 9-15](#) will enable autonomous mode and configure all the ports to the same Power Allocation settings. In the event a PD is connected with a higher requested class than the autonomous mode configuration, the port will power demote the PD to the selected autonomous mode configuration power level.

表 9-15. AUTO Pin Programming

AUTO Pin	Autonomous Mode Configuration	Resulting Register Configurations		
		0x12h	0x14h	0x29h
Open/Floating	Disabled	0000, 0000b	0000, 0000b	0000, 0000b
124 k Ω	2-pair 15W	1111, 1111b	1111, 1111b	0000, 0000b
62 k Ω	2-pair 30W	1111, 1111b	1111, 1111b	0011 0011b

备注

A 10 nF capacitor is required in parallel with R_{AUTO} to ensure stability in the Autonomous mode selection.

The I²C interface is still fully operational in Autonomous mode, and the all of the port telemetry and configurability is still supported

The AUTO pin resistance (R_{AUTO}) will not be measured following a device reset (assertion of the RESET pin or RESAL bit in register 0x1A). The device will only measure (R_{AUTO}) and pre-configure the internal registers during power up (V_{VPWR} and V_{VDD} rising above their respective UVLO thresholds).

备注

The device SRAM will need to be programmed in order to support applications that desire to remove a device from Autonomous mode after having initially powered up in Autonomous mode.

A device running from the internal ROM (SRAM unprogrammed) in Autonomous mode will turn off and automatically resume discovery and power on any valid loads following the assertion of the RESET pin, I²C register 0x1A RESAL or RESPn bits, or a mode off command. Whereas a device running in Autonomous mode with the SRAM programmed will turn off and remain inactive until the host re-enables the port(s) through the I²C bus.

9.6.2.14 OPERATING MODE Register

COMMAND = 12h with 1 Data Byte, Read/Write

图 9-19. OPERATING MODE Register Format

7	6	5	4	3	2	1	0
C4M1	C4M0	C3M1	C3M0	C2M1	C2M0	C1M1	C1M0
R/W-0	R/W-0	R/W-0	R/W-0	R/W-0	R/W-0	R/W-0	R/W-0

LEGEND: R/W = Read/Write; R = Read only; -n = value after reset

表 9-16. OPERATING MODE Register Field Descriptions

Bit	Field	Type	Reset	Description															
7-0	CnM1 - CnM0	R/W	0	Each pair of bits configures the operating mode per channel. The selection is as following: <table border="1" data-bbox="597 674 964 858"> <thead> <tr> <th>M1</th> <th>M0</th> <th>Operating Mode</th> </tr> </thead> <tbody> <tr> <td>0</td> <td>0</td> <td>OFF</td> </tr> <tr> <td>0</td> <td>1</td> <td>Diagnostic/Manual</td> </tr> <tr> <td>1</td> <td>0</td> <td>Semiauto</td> </tr> <tr> <td>1</td> <td>1</td> <td>Auto</td> </tr> </tbody> </table>	M1	M0	Operating Mode	0	0	OFF	0	1	Diagnostic/Manual	1	0	Semiauto	1	1	Auto
M1	M0	Operating Mode																	
0	0	OFF																	
0	1	Diagnostic/Manual																	
1	0	Semiauto																	
1	1	Auto																	

OFF MODE:

In OFF mode, the Channel is OFF and neither detection nor classification is performed independent of the DETE, CLSE or PWON bits.

The table below depicts what bits will be cleared when a channel is changed to OFF mode from any other operating mode:

表 9-17. Transition to OFF Mode

Register	Bits to be reset
0x04	CLSCn and DETCn
0x06	DISFn and PCUTn
0x08	STRTn and ILIMn
0x0C-0F	Requested Class and Detection
0x10	PGn and PEn
0x14	CLEn and DETEn
0x1C	ACn
0x1E-21	2P Policing set to 0xFFh
0x24	PFn
0x30-3F	Channel Voltage and Current Measurements
0x40	2xFBn
0x44 - 47	Detection Resistance Measurements
0x4C-4F	Assigned Class and Previous Class
0x51-54	Autoclass Measurement

备注

it may take upwards of 5 ms before all of the registers are cleared following a change to OFF mode.

Only the bits associated with the channel/port ("n") being set into OFF mode will be cleared. Those bits associated with channels/ports remaining in operation will not be changed.

In the event either the PGn or PEn bits were changed from a 1 to a zero, the corresponding PGCn and PECn bits will be set in the POWER EVENT register 0x02h.

Also, a change of mode from semiauto to manual/diagnostic mode or OFF mode will cancel any ongoing cooldown time period.

DIAGNOSTIC/MANUAL MODE:

In Manual/Diagnostic mode, there is no automatic state change. The channel remains idle until DETE, CLSE (0x14h or 0x18h), or PWON command is provided. Upon the setting of the DETE and/or CLSE bits, the channel will perform a singular detection and/or classification cycle on the corresponding channel.

备注

Setting a PWONn bit in register 0x19 results in the immediate turn on of that channel.

There is no Assigned Class assigned for ports/channels powered out of Manual/Diagnostic mode. Any settings such as the port power policing and 1x/2x foldback selection that are typically configured based on the assigned class result need to be manually configured by the user.

备注

Setting a PWONn bit in register 0x19 results in the immediate turn on of that channel.

SEMIAUTO MODE:

In semiauto mode, as long as the Channel is unpowered, detection and classifications may be performed continuously depending if the corresponding class and detect enable bits are set (register 0x14h).

表 9-18. Channel Behavior in Semiauto Mode

CLEn	DETn	Channel Operation
0	0	Idle
0	1	Cycling Detection Measurements only
1	0	Idle
1	1	Cycling Detection and Classification Measurements

AUTO MODE:

In **auto mode**, channels will automatically power on any valid detection and classification signature based on the Port Power Allocation settings in 0x29. The channels will remain idle until DETE and CLSE (0x14 or 0x18) are set, or a PWON command is given.

Prior to setting DETE and CLE or sending a PWON command in AUTO mode, the following registers need to be configured according to the system requirements and configuration:

Register	Bits
0x26	Port Re-mapping
0x29	Port Power Allocation
0x50	Auto AC Enable
0x55	Alternative Inrush and Powered Foldback Enable

备注

Changes to these registers after the DETE and CLE bits are set in auto mode may result in undesired or non IEEE complaint operation.

The following registers may be configured or changed after turn on if changes to the default operation are desired as these values are internally set during power on based on the port configuration and resulting assigned PD class:

Register	Bits
0x1E-21	2-Pair Policing
0x40	2x Foldback Enable

9.6.2.15 DISCONNECT ENABLE Register

COMMAND = 13h with 1 Data Byte, Read/Write

Bit Descriptions: Defines the disconnect detection mechanism for each channel.

图 9-20. DISCONNECT ENABLE Register Format

7	6	5	4	3	2	1	0
-	-	-	-	DCDE4	DCDE3	DCDE2	DCDE1
R/W-0	R/W-0	R/W-0	R/W-0	R/W-1	R/W-1	R/W-1	R/W-1

LEGEND: R/W = Read/Write; R = Read only; -n = value after reset

表 9-19. DISCONNECT ENABLE Register Field Descriptions

Bit	Field	Type	Reset	Description
7 - 4	—	R/W	0	
3 - 0	DCDE4 - DCDE1	R/W	1	DC disconnect enable 1 = DC Disconnect Enabled 0 = DC Disconnect Disabled Look at the TIMING CONFIGURATION register for more details on how to define the TDIS time period.

DC disconnect consists in measuring the Channel DC current at SENn, starting a timer (T_{DIS}) if this current is below a threshold and turning the Channel off if a time-out occurs. Also, the corresponding disconnect bit (DISFn) in the FAULT EVENT register is set accordingly. The T_{DIS} counter is reset each time the current rises above the disconnect threshold for at least 3 msec. The counter does not decrement below zero.

9.6.2.16 DETECT/CLASS ENABLE Register

COMMAND = 14h with 1 Data Byte, Read/Write

During t_{OVLD} , t_{LIM} or t_{START} cool down cycle, any Detect/Class Enable command for that channel will be delayed until end of cool-down period. Note that at the end of cool down cycle, one or more detection/class cycles are automatically restarted as described previously, if the class and/or detect enable bits are set.

图 9-21. DETECT/CLASS ENABLE Register Format

7	6	5	4	3	2	1	0
CLE4	CLE3	CLE2	CLE1	DETE4	DETE3	DETE2	DETE1
R/W-0	R/W-0	R/W-0	R/W-0	R/W-0	R/W-0	R/W-0	R/W-0

LEGEND: R/W = Read/Write; R = Read only; -n = value after reset

表 9-20. DETECT/CLASS ENABLE Register Field Descriptions

Bit	Field	Type	Reset	Description
7 - 4	CLE4-CLE1	R/W	0	Classification enable bits.
3 - 0	DETE4-DETE1	R/W	0	Detection enable bits.

Bit Descriptions:

Detection and classification enable for each channel.

When in Manual mode, setting a bit means that only one cycle (detection or classification) is performed for the corresponding channel. The bit is automatically cleared by the time the cycle has been completed.

Note that similar result can be obtained by writing to the Detect/Class Restart register 0x18.

It is also cleared if a turn off (Power Enable register) command is issued.

When in semiauto mode, as long as the port is kept off, detection and classification are performed continuously, as long as the class and detect enable bits are kept set, but the class will be done only if the detection was valid. A Detect/Class Restart PB command can also be used to set the CLEn and DETEn bits, if in semiauto mode.

9.6.2.17 Power Priority / 2Pair PCUT Disable Register Name

COMMAND = 15h with 1 Data Byte, R/W

图 9-22. Power Priority / 2P-PCUT Disable Register Format

7	6	5	4	3	2	1	0
OSS4	OSS3	OSS2	OSS1	DCUT4	DCUT3	DCUT2	DCUT1
R/W-0	R/W-0	R/W-0	R/W-0	R/W-0	R/W-0	R/W-0	R/W-0

LEGEND: R/W = Read/Write; R = Read only; -n = value after reset

表 9-21. Power Priority / 2P-PCUT Disable Register Field Descriptions

Bit	Field	Type	Reset	Description
7 - 4	OSS4-OSS1	R/W	0	Power priority bits: When the MBitPrty bit in 0x17 =0: 1 = When the OSS signal is asserted, the corresponding channel is powered off. 0 = OSS signal has no impact on the channel.
3 - 0	DCUT4-DCUT1	R/W	0	2-Pair PCUT disable for each channel. Used to prevent removal of the associated channel' s power due to a 2-Pair PCUT fault, regardless of the programming status of the Timing Configuration register. Note that there is still monitoring of ILIM faults. 1: Channel' s PCUT is disabled. This means that an PCUT fault alone will not turn off this channel. 0: Channel' s PCUT is enabled. This enables channel turn off if there is PCUT fault.

备注

If the MbitPrty bit = 1 (0x17h): The OSSn bits must be cleared to ensure proper operation. Refer to registers 0x27/28h for more information on the Multi-bit priority shutdown feature.

备注

If DCUT = 1 for a channel, the channel will not be automatically turned off during a PCUT fault condition. However, the PCUT fault flag will still be operational, with a fault timeout equal to $t_{OVL D}$.

Any change in the state of DCUTn bits will result in the resetting of the $T_{OVL D}$ timer for that channel.

The OSSn bits are used to determine which channels are shut down in response to an external assertion of the OSS fast shutdown signal.

The turn off procedure due to OSS is similar to a channel reset or change to OFF mode, with the exception that OSS does not cancel any ongoing fault cool down timers. the table below includes the bits that will be cleared when a channel is disabled due to OSS:

表 9-22. Channel Turn Off with OSS

Register	Bits to be reset
0x04	CLSCn and DETCn
0x06	DISFn and PCUTn
0x08	STRTn and ILIMn
0x0C-0F	Requested Class and Detection
0x10	PGn and PEn
0x14	CLEn and DETEn
0x1C	ACn
0x1E-21	2P Policing set to 0xFFh
0x24	PFn
0x30-3F	Channel Voltage and Current Measurements
0x40	2xFBn
0x44 - 47	Detection Resistance Measurements
0x4C-4F	Assigned Class and Previous Class
0x51-54	Autoclass Measurement

备注

it may take upwards of 5 ms before all of the registers are cleared following an OSS event.

Only the bits associated with the channel/port ("n") with OSS enabled will be cleared. Those bits associated with channels/ports remaining in operation will not be changed.

9.6.2.18 TIMING CONFIGURATION Register

COMMAND = 16h with 1 Data Byte, Read/Write

Bit Descriptions: These bits define the timing configuration for **all four** channels.

图 9-23. TIMING CONFIGURATION Register Format

7	6	5	4	3	2	1	0
TLIM		TSTART		TOVLD		TMPDO	
R/W-0	R/W-0	R/W-0	R/W-0	R/W-0	R/W-0	R/W-0	R/W-0

LEGEND: R/W = Read/Write; R = Read only; -n = value after reset

表 9-23. TIMING CONFIGURATION Register Field Descriptions

Bit	Field	Type	Reset	Description														
7 - 6	TLIM	R/W	0	<p>ILIM fault timing, which is the output current limit time duration before channel turn off. When a 2xFBn bit in register 0x40 = 0, the t_{LIM} used for the associated channel is always the nominal value (about 60 ms).</p> <p>This timer is active and increments to the settings defined below after expiration of the TSTART time window and when the channel is limiting its output current to I_{LIM}. If the ILIM counter is allowed to reach the programmed time-out duration specified below, the channel will be powered off. The 1-second cool down timer is then started, and the channel can not be turned-on until the counter has reached completion.</p> <p>In other circumstances (ILIM time-out has not been reached), while the channel current is below I_{LIM}, the same counter decrements at a rate 1/16th of the increment rate. The counter does not decrement below zero. The ILIM counter is also cleared in the event of a turn off due to a Power Enable or Reset command, a DC disconnect event or the OSS input.</p> <p>Note that in the event the TLIM setting is changed while this timer is already active for a channel, this timer is automatically reset then restarted with the new programmed time-out duration.</p> <p>Note that at the end of cool down cycle, when in semiauto mode, a detection cycle is automatically restarted if the detect enable bit is set. Also note that the cool down time count is immediately canceled with a reset command, or if the OFF or Manual mode is selected.</p> <p>If 2xFBn bit is asserted in register 0x40, then t_{LIM} for associated channel is programmable with the following selection:</p> <table border="1" data-bbox="566 1262 1000 1451"> <thead> <tr> <th>TLIM</th> <th>Minimum t_{LIM} (ms)</th> </tr> </thead> <tbody> <tr> <td>0</td> <td>0</td> <td>58</td> </tr> <tr> <td>0</td> <td>1</td> <td>15</td> </tr> <tr> <td>1</td> <td>0</td> <td>10</td> </tr> <tr> <td>1</td> <td>1</td> <td>6</td> </tr> </tbody> </table>	TLIM	Minimum t_{LIM} (ms)	0	0	58	0	1	15	1	0	10	1	1	6
TLIM	Minimum t_{LIM} (ms)																	
0	0	58																
0	1	15																
1	0	10																
1	1	6																
5-4	TSTART (or TINRUSH)	R/W	0	<p>START fault timing, which is the maximum allowed overcurrent time during inrush. If at the end of TSTART period the current is still limited to I_{Inrush}, the channel is powered off. This is followed by a 1-second cool down period, during which the channel can not be turned-on. Note that at the end of cool down cycle, when in semiauto mode, a detection cycle is automatically restarted if the class and detect enable bits are set.</p> <p>Note that in the event the TSTART setting is changed while this timer is already active for a channel, this new setting is ignored and will be applied only next time the channel is turned ON. The selection is as following:</p> <table border="1" data-bbox="566 1724 1000 1913"> <thead> <tr> <th>TSTART</th> <th>Nominal t_{START} (ms)</th> </tr> </thead> <tbody> <tr> <td>0</td> <td>0</td> <td>60</td> </tr> <tr> <td>0</td> <td>1</td> <td>30</td> </tr> <tr> <td>1</td> <td>0</td> <td>120</td> </tr> <tr> <td>1</td> <td>1</td> <td>Reserved</td> </tr> </tbody> </table>	TSTART	Nominal t_{START} (ms)	0	0	60	0	1	30	1	0	120	1	1	Reserved
TSTART	Nominal t_{START} (ms)																	
0	0	60																
0	1	30																
1	0	120																
1	1	Reserved																

表 9-23. TIMING CONFIGURATION Register Field Descriptions (continued)

Bit	Field	Type	Reset	Description															
3 - 2	TOVLD	R/W	0	<p>PCUT fault timing, which is the overcurrent time duration before turn off. This timer is active and increments to the settings defined below after expiration of the TSTART time window and when the current meets or exceeds P_{CUT}, or when it is limited by the current foldback. If the PCUT counter is allowed to reach the programmed time-out duration specified below, the channel will be powered off. The 1-second cool down timer is then started, and the channel can not be turned-on until the counter has reached completion.</p> <p>In other circumstances (PCUT time-out has not been reached), while the current is below P_{CUT}, the same counter decrements at a rate 1/16th of the increment rate. The counter does not decrement below zero. The PCUT counter is also cleared in the event of a turn off due to a Power Enable or Reset command, a DC disconnect event or the OSS input</p> <p>Note that in the event the TOVLD setting is changed while this timer is already active for a channel, this timer is automatically reset then restarted with the new programmed time-out duration.</p> <p>Note that at the end of cool down cycle, when in semiauto mode, a detection cycle is automatically restarted if the detect enable bit is set. Also note that the cool down time count is immediately canceled with a reset command, or if the OFF or Manual mode is selected.</p> <p>Note that if a DCUTn bit is high in the Power Priority/PCUT Disable register, the PCUT fault timing for the associated channel is still active. However, even though the channel will not be turned off when the tOVLD time expires, the PCUT fault bits will still be set.</p> <p>The selection is as following:</p> <table border="1"> <thead> <tr> <th colspan="2">TOVLD</th> <th>Nominal t_{OVLD} (ms)</th> </tr> </thead> <tbody> <tr> <td>0</td> <td>0</td> <td>60</td> </tr> <tr> <td>0</td> <td>1</td> <td>30</td> </tr> <tr> <td>1</td> <td>0</td> <td>120</td> </tr> <tr> <td>1</td> <td>1</td> <td>240</td> </tr> </tbody> </table>	TOVLD		Nominal t_{OVLD} (ms)	0	0	60	0	1	30	1	0	120	1	1	240
TOVLD		Nominal t_{OVLD} (ms)																	
0	0	60																	
0	1	30																	
1	0	120																	
1	1	240																	
1 - 0	TMPDO	R/W	0	<p>Disconnect delay, which is the time to turn off a channel once there is a disconnect condition, and if the dc disconnect detect method has been enabled.</p> <p>The TDIS counter is reset each time the current goes continuously higher than the disconnect threshold for nominally 15 ms.</p> <p>The counter does not decrement below zero.</p> <p>The selection is as following:</p> <table border="1"> <thead> <tr> <th colspan="2">TMPDO</th> <th>Nominal t_{MPDO} (ms)</th> </tr> </thead> <tbody> <tr> <td>0</td> <td>0</td> <td>360</td> </tr> <tr> <td>0</td> <td>1</td> <td>90</td> </tr> <tr> <td>1</td> <td>0</td> <td>180</td> </tr> <tr> <td>1</td> <td>1</td> <td>180</td> </tr> </tbody> </table>	TMPDO		Nominal t_{MPDO} (ms)	0	0	360	0	1	90	1	0	180	1	1	180
TMPDO		Nominal t_{MPDO} (ms)																	
0	0	360																	
0	1	90																	
1	0	180																	
1	1	180																	

备注

The PGn and PEn bits (Power Status register) are cleared when there is a TLIM, TOVLD, TMPDO, or TSTART fault condition.

备注

The settings for t_{LIM} set the minimum timeout based on the IEEE compliance requirements.

9.6.2.19 GENERAL MASK Register

COMMAND = 17h with 1 Data Byte, Read/Write

图 9-24. GENERAL MASK Register Format

7	6	5	4	3	2	1	0
INTEN	-	nbitACC	MbitPrty	CLCHE	DECHE	-	-
R/W-1	R/W-0	R/W-0	R/W-0	R/W-0	R/W-0	R/W-0	R/W-0

LEGEND: R/W = Read/Write; R = Read only; -n = value after reset

表 9-24. GENERAL MASK Register Field Descriptions

Bit	Field	Type	Reset	Description
7	INTEN	R/W	1	INT pin mask bit. Writing a 0 will mask any bit of Interrupt register from activating the INT output, whatever the state of the Interrupt Mask register. Note that activating INTEN has no impact on the event registers. 1 = Any unmasked bit of Interrupt register can activate the INT output 0 = INT output cannot be activated
6	-	R/W	0	
5	nbitACC	R/W	0	I ² C Register Access Configuration bit. 1 = Configuration B. This means 16-bit access with a single device address (A0 = 0). 0 = Configuration A. This means 8-bit access, while the 8-channel device is treated as 2 separate 4-channel devices with 2 consecutive target addresses. See register 0x11 for more information on the I2C address programming
4	MbitPrty	R/W	0	Multi Bit Priority bit. Used to select between 1-bit shutdown priority and 3-bit shutdown priority. 1 = 3-bit shutdown priority. Register 0x27 and 0x28 need to be followed for priority and OSS action. 0 = 1-bit shutdown priority. Register 0x15 needs to be followed for priority and OSS action
3	CLCHE	R/W	0	Class change Enable bit. When set, the CLSCn bits in Detection Event register only indicates when the result of the most current classification operation differs from the result of the previous one. 1 = CLSCn bit is set only when a change of class occurred for the associated channel. 0 = CLSCn bit is set each time a classification cycle occurred for the associated channel.
2	DECHE	R/W	0	Detect Change Enable bit. When set, the DETCn bits in Detection Event register only indicates when the result of the most current detection operation differs from the result of the previous one. 1 = DETCn bit is set only when a change in detection occurred for the associated channel. 0 = DETCn bit is set each time a detection cycle occurred for the associated channel.
1	-	R/W	0	
0	-	R/W	0	

备注

If the MbitPrty bit needs to be changed from 0 to 1, make sure the OSS input pin is in the idle (low) state for a minimum of 200 μ sec prior to setting the MbitPrty bit, to avoid any misbehavior related to loss of synchronization with the OSS bit stream.

备注

Only the nbitACC bit for channels 1-4 needs to be set to enable 16-bit I²C operation.

表 9-25. nbitACC = 1: Register Operations in 8-Bit (Config A) and 16-bit (Config B) I²C Mode

Cmd Code	Register or Command Name	Bits Description	Configuration A (8-bit)	Configuration B (16-bit)
00h	INTERRUPT	INT bits P1-4, P5-8	Separate mask and interrupt result per group of 4 channels.	
01h	INTERRUPT MASK	MSK bits P1-4, P5-8	The Supply event bit is repeated twice.	
02h	POWER EVENT	PGC_PEC P4-1, P8-5	Separate event byte per group of 4 channels.	
03h				
04h	DETECTION EVENT	CLS_DET P4-1, P8-5		
05h				
06h	FAULT EVENT	DIS_PCUT P4-1, P8-5		
07h				
08h	START/ILIM EVENT	ILIM_STR P4-1, P8-5		
09h				
0Ah	SUPPLY/FAULT EVENT	TSD, VDUV, VDUW, VPUV, RAMFLT OSSE4-1, OSSE8-5	Both 8-bit registers (channel 1 to 4 and channel 5 to 8) will show the same results for TSD, VDUV, VPUV and RAMFLT. The PCUTxx and OSSEx bits will have separate status per group of 4 channels. Clearing at least one VPUV/VDUV also clears the other one.	
0Bh				
0Ch	CHANNEL 1 DISCOVERY	CLS&DET1_CLS&DET5	Separate Status byte per channel	
0Dh	CHANNEL 2 DISCOVERY	CLS&DET2_CLS&DET6		
0Eh	CHANNEL 3 DISCOVERY	CLS&DET3_CLS&DET7		
0Fh	CHANNEL 4 DISCOVERY	CLS&DET4_CLS&DET8		
10h	POWER STATUS	PG_PE P4-1, P8-5	Separate status byte per group of 4 channels	
11h	PIN STATUS	A4-A1,A0	Both 8-bit registers (channel 1 to 4 and channel 5 to 8) will show the same result, except that A0 = 0 (channel 1 to 4) or 1 (channel 5 to 8).	Both 8-bit registers (channel 1 to 4 and channel 5 to 8) will show the same result, including A0 = 0.
12h	OPERATING MODE	MODE P4-1, P8-5	Separate Mode byte per group of 4 channels.	
13h	DISCONNECT ENABLE	DCDE P4-1, P8-5	Separate DC disconnect enable byte per group of 4 channels.	
14h	DETECT/CLASS ENABLE	CLE_DETE P4-1, P8-5	Separate Detect/Class Enable byte per group of 4 channels.	
15h	PWRPR/2P-PCUT DISABLE	OSS_DCUT P4-1, P8-5	Separate OSS/DCUT byte per group of 4 channels.	
16h	TIMING CONFIG	TLIM_TSTRT_TOVLD_TMPD O P4-1, P8-5	Separate Timing byte per group of 4 channels.	
17h	GENERAL MASK	P4-1, P8-5 including n-bit access	Separate byte per group of 4 channels. n-bit access: Setting this in at least one of the virtual quad register space is enough to enter Config B mode. To go back to config A, clear both. MbitPrty: Setting this in at least one of the virtual quad register space is enough to enter 3-bit shutdown priority. To go back to 1-bit shutdown, clear both MbitPrty bits.	
18h	DETECT/CLASS Restart	RCL_RDET P4-1, P8-5	Separate DET/CL RST byte per group of 4 channels	
19h	POWER ENABLE	POF_PWON P4-1, P8-5	Separate POF/PWON byte per group of 4 channels	
1Ah	RESET	P4-1, P8-5	Separate byte per group of 4 channels, Clear Int pin and Clear All int.	Separate byte per group of 4 channels.
1Bh	ID		Both 8-bit registers (channel 1 to 4 and channel 5 to 8) will show the same result unless modified through I ² C.	
1Ch	AUTOCLASS	AC4-1, AC8-5	Separate byte per group of 4 channels.	
1Eh	2P POLICE 1/5 CONFIG	POL1, POL5	Separate Policing byte per channel.	
1Fh	2P POLICE 2/6 CONFIG	POL2, POL6		
20h	2P POLICE 3/7 CONFIG	POL3, POL7		
21h	2P POLICE 4/8 CONFIG	POL4, POL8		

表 9-25. nbitACC = 1: Register Operations in 8-Bit (Config A) and 16-bit (Config B) I²C Mode (continued)

Cmd Code	Register or Command Name	Bits Description	Configuration A (8-bit)	Configuration B (16-bit)
22h	CAP MEASUREMENT	CDET4-1, CDET8-5	Separate capacitance measurement enable bytes per group of 4 channels.	
24h	Power-on FAULT	PF P4-1, P8-5	Separate Power-on FAULT byte per group of 4 channels	
25h				
26h	PORT REMAPPING	Logical P4-1, P8-5	Separate Remapping byte per group of 4 channels. Reinitialized only if POR or RESET pin. Kept unchanged if 0x1A IC reset or CPU watchdog reset.	
27h	Multi-Bit Priority 21 / 65	MBP2-1, MBP6-5	Separate MBP byte per group of 2 channels	
28h	Multi-Bit Priority 43 / 87	MBP4-3, MBP8-7	Separate MBP byte per group of 2 channels	
29h	PORT POWER ALLOCATION	MC34-12, MC78-56	Separate MCnn byte per group of 4 channels	
2Ch	TEMPERATURE	TEMP P1-4, P5-8	Both 8-bit registers (channel 1 to 4 and channel 5 to 8) must show the same result.	
2Eh	INPUT VOLTAGE	VPWR P1-4, P5-8	Both 8-bit registers (channel 1 to 4 and channel 5 to 8) must show the same result.	
2Fh				
30h	CHANNEL 1 CURRENT	I1, I5	Separate 2-byte per group of 4 channels	Separate 2-byte per group of 4 channels. 2-byte Read at 0x30 gives I1 4-byte Read at 0x30 gives I1, I5.
31h			N/A	2-byte Read at 0x31 gives I5.
32h	CHANNEL 1 VOLTAGE	V1, V5	Separate 2-byte per group of 4 channels	2-byte Read at 0x32 gives V1 4-byte Read at 0x32 gives V1, V5.
33h			N/A	2-byte Read at 0x33 gives V5.
34h	CHANNEL 2 CURRENT	I2, I6	Separate 2-byte per group of 4 channels	2-byte Read at 0x34 gives I2 4-byte Read at 0x34 gives I2, I6.
35h			N/A	2-byte Read at 0x35 gives I6.
36h	CHANNEL 2 VOLTAGE	V2, V6	Separate 2-byte per group of 4 channels	2-byte Read at 0x36 gives V2 4-byte Read at 0x36 gives V2, V6.
37h			N/A	2-byte Read at 0x37 gives V6.
38h	CHANNEL 3 CURRENT	I3, I7	Separate 2-byte per group of 4 channels	2-byte Read at 0x38 gives I3 4-byte Read at 0x38 gives I3, I7.
39h			N/A	2-byte Read at 0x39 gives I7.
3Ah	CHANNEL 3 VOLTAGE	V3, V7	Separate 2-byte per group of 4 channels	2-byte Read at 0x3A gives V3 4-byte Read at 0x3A gives V3, V7.
3Bh			N/A	2-byte Read at 0x3B gives V7.
3Ch	CHANNEL 4 CURRENT	I4, I8	Separate 2-byte per group of 4 channels	2-byte Read at 0x3C gives I4 4-byte Read at 0x3C gives I4, I8.
3Dh			N/A	2-byte Read at 0x3D gives I8.
3Eh	CHANNEL 4 VOLTAGE	V4, V8	Separate 2-byte per group of 4 channels	2-byte Read at 0x3E gives V4 4-byte Read at 0x3E gives V4, V8.
3Fh			N/A	2-byte Read at 0x3F gives V8.
40h	OPERATIONAL FOLDBACK	2xFB4-1, 2xFB8-5	Separate 2xFBn config byte per group of 4 channels.	
41h	FIRMWARE REVISION	FRV P1-4, P5-8	Both 8-bit registers (channel 1 to 4 and channel 5 to 8) must show the same result.	
42h	I2C WATCHDOG	P1-4, P5-8	IWD3-0: if at least one of the two 4-port settings is different than 1011b, the watchdog is enabled for all 8 channels. WDS: Both 8-bit registers (channel 1 to 4 and channel 5 to 8) must show the same WDS result. Each WDS bit needs to be cleared individually through I ² C.	
43h	DEVICE ID	DID_SR P1-4, P5-8	Both 8-bit registers (channel 1 to 4 and channel 5 to 8) will show the same result .	
44h	CHANNEL 1 RESISTANCE	RDET1, RDET5	Separate byte per channel. Detection resistance always updated, detection good or bad.	
45h	CHANNEL 2 RESISTANCE	RDET2, RDET6		
46h	CHANNEL 3 RESISTANCE	RDET3, RDET7		
47h	CHANNEL 4 RESISTANCE	RDET4, RDET8		

表 9-25. nbitACC = 1: Register Operations in 8-Bit (Config A) and 16-bit (Config B) I²C Mode (continued)

Cmd Code	Register or Command Name	Bits Description	Configuration A (8-bit)	Configuration B (16-bit)
4Ch	CHANNEL 1 ASSIGNED CLASS	ACLS&PCLS1_ACLS&PCLS5	Separate Status byte per channel	
4Dh	CHANNEL 2 ASSIGNED CLASS	ACLS&PCLS2_ACLS&PCLS6		
4Eh	CHANNEL 3 ASSIGNED CLASS	ACLS&PCLS3_ACLS&PCLS7		
4Fh	CHANNEL 4 ASSIGNED CLASS	ACLS&PCLS4_ACLS&PCLS8		
50h	AUTOCLASS CONTROL	MAC4-1, AAC4-1, MAC8-5, AAC8-5	Separate Auto Class control bytes per 4 channels	
51h	AUTOCLASS POWER 1/5	PAC1, PAC5	Separate Auto Class Power Measurement byte per channel	
52h	AUTOCLASS POWER 2/6	PAC2, PAC6		
53h	AUTOCLASS POWER 3/7	PAC3, PAC7		
54h	AUTOCLASS POWER 4/8	PAC4, PAC8		
55h	ALTERNATIVE FOLDBACK	ALTFB4-1, ALTIR4-1, ALTFN8-5, ALTIR8-5	Separate Alternative Foldback byte per group of 4 channels	
60h	SRAM CONTROL	SRAM CNTRL BITS	These bits must be configured for the lower virtual quad (A0=0, CH 1-4)). These bits have no functionality for the upper virtual quad (A0=1, Ch 5-8) device	
61h	SRAM DATA		Streaming data input is independent of I ² C configuration	
62h	START ADDRESS (LSB)		These bits must be configured for the lower virtual quad (A0=0, CH 1-4)). These bits have no functionality for the upper virtual quad (A0=1, Ch 5-8) device	
63h	START ADDRESS (MSB)		These bits must be configured for the lower virtual quad (A0=0, CH 1-4)). These bits have no functionality for the upper virtual quad (A0=1, Ch 5-8) device	

9.6.2.20 DETECT/CLASS RESTART Register

COMMAND = 18h with 1 Data Byte, Write Only

Push button register.

Each bit corresponds to a particular cycle (detect or class restart) per channel. Each cycle can be individually triggered by writing a 1 at that bit location, while writing a 0 does not change anything for that event.

In Diagnostic/Manual mode, a single cycle (detect or class restart) will be triggered when these bits are set while in semiauto mode, it sets the corresponding bit in the Detect/Class Enable register 0x14.

A Read operation will return 00h.

During t_{OVLD} , t_{LIM} or t_{START} cool down cycle, any Detect/Class Restart command for that channel will be accepted but the corresponding action will be delayed until end of cool-down period.

图 9-25. DETECT/CLASS RESTART Register Format

7	6	5	4	3	2	1	0
RCL4	RCL3	RCL2	RCL1	RDET4	RDET3	RDET2	RDET1
W-0	W-0	W-0	W-0	W-0	W-0	W-0	W-0

LEGEND: R/W = Read/Write; R = Read only; W = Write only; -n = value after reset

表 9-26. DETECT/CLASS RESTART Register Field Descriptions

Bit	Field	Type	Reset	Description
7 - 4	RCL4 - RCL1	W	0	Restart classification bit
3 - 0	RDET4 - RDET1	W	0	Restart detection bits

These bits may be used in place of completing a "Read-Modify-Write" sequence in register 0x14 to enable detection and classification on a per channel basis.

9.6.2.21 POWER ENABLE Register

COMMAND = 19h with 1 Data Byte, Write Only

Push button register.

Used to initiate a channel(s) turn on or turn off in any mode except OFF mode.

图 9-26. POWER ENABLE Register Format

7	6	5	4	3	2	1	0
POFF4	POFF3	POFF2	POFF1	PWON4	PWON3	PWON2	PWON1
W-0	W-0	W-0	W-0	W-0	W-0	W-0	W-0

LEGEND: R/W = Read/Write; R = Read only; W = Write only; -n = value after reset

表 9-27. POWER ENABLE Register Field Descriptions

Bit	Field	Type	Reset	Description
7 - 4	POFF4 - POFF1	W	0	Channel power off bits
3 - 0	PWON4 - PWON1	W	0	Channel power on bits

备注

Writing a “1” at POFFn and PWONn on same Channel during the same write operation turns the Channel off.

备注

The t_{OVLD} , t_{LIM} , t_{START} and disconnect events have priority over the PWON command. During t_{OVLD} , t_{LIM} or t_{START} , cool down cycle, any channel turn on using Power Enable command will be ignored and the Channel will be kept off.

PWONn in Diagnostic/Manual Mode:

If the PSE controller is configured in Diagnostic mode, writing a “1” at that PWONn bit location will immediately turn on the associated Channel.

PWONn in Semiauto Mode:

While in semiauto mode, writing a “1” at a PWONn bit will attempt to turn on the associated Channel. If the detection or class results are invalid, the Channel is not turned on, and there will be no additional attempts to turn on the Channel until this push button is reasserted and the channel will resume its configured semiauto mode operation.

备注

In semiauto mode, the Power Allocation (0x29h) value needs to be set prior to issuing a PWON command. Any changes to the Power Allocation value after a PWON command is given may be ignored.

表 9-28. Channel Response to PWONn Command in Semiauto Mode

CLEn	DETEn	Channel Operation	Result of PWONn Command
0	0	Idle	Singular Turn On attempted with Full DET and CLS cycle
0	1	Cycling Detection Measurements only	Singular Turn On attempted with Full DET and CLS cycle
1	0	Idle	Singular Turn On attempted with Full DET and CLS cycle
1	1	Cycling Detection and Classification Measurements	Singular Turn On attempted after next (or current) DET and CLS cycle

In semiauto mode with DETE and CLE set, as long as the PWONx command is received prior to the start of classification, the Channel will be powered immediately after classification is complete provided the classification result is valid and the power allocations settings (see register 0x29h) are sufficient to enable power on.

PWONn in Auto Mode:

In auto mode with DETE or CLE set to 0, a PWONx command will initiate a singular detection and classification cycle and the port/channel will be powered immediately after classification is complete provided the classification result is valid and the power allocations settings (see register 0x29h) are sufficient to enable power on.

In auto mode with DETE and CLE = 1, there is no need for a PWON command. The port/channel will automatically attempt to turn on after each detection and classification cycle.

备注

In auto mode, the Power Allocation (0x29h) value needs to be set prior to issuing a PWON command. Any changes to the Power Allocation value after a PWON command is given may be ignored.

表 9-29. Channel Response to PWONn Command in Auto Mode

CLEn	DETEn	Channel Operation	Result of PWONn Command
0	0	Idle	Singular Turn On attempted with Full DET and CLS cycle
0	1	Cycling Detection Measurements only	Singular Turn On attempted with Full DET and CLS cycle
1	0	Idle	Singular Turn On attempted with Full DET and CLS cycle
1	1	Cycling Detection and Classification Measurements	NA - Channel will power automatically after a valid detection and classification

PWOFFn in any Mode:

The channel is immediately disabled and the following registers are cleared:

表 9-30. Channel Turn Off with PWOFFn Command

Register	Bits to be Reset
0x04	CLSCn and DETCn
0x06	DISFn and PCUTn
0x08	STRTn and ILIMn
0x0C-0F	Requested Class and Detection
0x10	PGn and PEn
0x14	CLEn and DETEn
0x1C	ACn
0x1E-21	2P Policing set to 0xFFh
0x24	PFn
0x30-3F	Channel Voltage and Current Measurements
0x40	2xFBn
0x44 - 47	Detection Resistance Measurements
0x4C-4F	Assigned Class and Previous Class
0x51-54	Autoclass Measurement

备注

It may take upwards of 5ms after PWOFFn command for all register values to be updated.

Only the bits associated with the channel/port ("n") with PWOFFn set will be cleared. Those bits associated with channels/ports remaining in operation will not be changed.

9.6.2.22 RESET Register

COMMAND = 1Ah with 1 Data Byte, Write Only

Push button register.

Writing a 1 at a bit location triggers an event while a 0 has no impact. Self-clearing bits.

图 9-27. RESET Register Format

7	6	5	4	3	2	1	0
CLRAIN	CLINP	-	RESAL	RESP4	RESP3	RESP2	RESP1
W-0	W-0	W-0	W-0	W-0	W-0	W-0	W-0

LEGEND: R/W = Read/Write; R = Read only; W = Write only; -n = value after reset

表 9-31. RESET Register Field Descriptions

Bit	Field	Type	Reset	Description
7	CLRAIN	W	0	Clear all interrupts bit. Writing a 1 to CLRAIN clears all event registers and all bits in the Interrupt register. It also releases the $\overline{\text{INT}}$ pin
6	CLINP	W	0	When set, it releases the $\overline{\text{INT}}$ pin without any impact on the Event registers nor on the Interrupt register.
5	-	W	0	
4	RESAL	W	0	Reset all bits when RESAL is set. Results in a state similar to a power-up reset. Note that the VDUV and VPUV bits (Supply Event register) follow the state of VDD and VPWR supply rails.
3 - 0	RESP4 - RESP1	W	0	Reset channel bits. Used to force an immediate channel(s) turn off in any mode, by writing a 1 at the corresponding RESPn bit location(s).

Setting the RESAL bit will result in all of the I2C register being restored to the RST condition with the exception of those in the following table:

Register	Bits	RESAL Result
0x00	All	Pre RESAL value will remain
0x0A/B	TSD, VPUV, VDWRN, and VPUV	
0x26	All	
0x2C and 0x2E	All	
0x41	All	

备注

Setting the RESAL bit for only one group of four channels (1-4 or 5-8) will result in only those four channels being reset.

备注

After using the CLINP command, the $\overline{\text{INT}}$ pin will not be reasserted for any interrupts until all existing interrupts have been cleared.

Setting the RESPn bit will immediate turn off the associated channel and clear the registers according to the following table:

表 9-32. Channel Turn Off with RESPn Command

Register	Bits to be Reset
0x04	CLSCn and DETCn
0x06	DISFn and PCUTn
0x08	STRTn and ILIMn
0x0C-0F	Requested Class and Detection
0x10	PGn and PEn
0x14	CLEn and DETEn
0x1C	ACn
0x1E-21	2P Policing set to 0xFFh
0x24	PFn
0x30-3F	Channel Voltage and Current Measurements
0x40	2xFBn
0x44 - 47	Detection Resistance Measurements
0x4C-4F	Assigned Class and Previous Class
0x51-54	Autoclass Measurement

备注

Only the bits associated with the channel/port ("n") with RESPn set will be cleared. Those bits associated with channels/ports remaining in operation will not be changed.

it may take upwards of 5 ms before all of the registers are cleared following a RESPn command.

The RESPn command will cancel any ongoing cool down cycles .

Users need to wait at least 3ms before trying to reenable discovery or power on ports following a RESPn command.

9.6.2.23 ID Register

COMMAND = 1Bh with 1 Data Byte, Read/Write

图 9-28. ID Register Format

7	6	5	4	3	2	1	0
MFR ID					ICV		
R/W-0	R/W-1	R/W-0	R/W-1	R/W-0	R/W-1	R/W-0	R/W-1

LEGEND: R/W = Read/Write; R = Read only; -n = value after reset

表 9-33. ID Register Field Descriptions

Bit	Field	Type	Reset	Description
7 - 3	MFR ID	R/W	01010 b	Manufacture Identification number (0101,0)
2 - 0	ICV	R/W	101b	IC version number (011)

9.6.2.24 Connection Check and Auto Class Status Register

COMMAND = 1Ch with 1 Data Byte, Read Only

图 9-29. Connection Check and Auto Class Register Format

7	6	5	4	3	2	1	0
AC4	AC3	AC2	AC1	Rsvrd	Rsvrd	Rsvrd	Rsvrd
R-0	R-0	R-0	R-0	R-0	R-0	R-0	R-0

LEGEND: R/W = Read/Write; R = Read only; -n = value after reset

表 9-34. Connection Check and Auto Class Field Descriptions

Bit	Field	Type	Reset	Description
7 - 4	ACn	R	0000b	Auto Class Detection Status 1 = PD supports Auto Class 0 = PD does not support Auto Class
3-0	Rsvrd	R	00b	Reserved

Auto Class:

The auto class detection measurement is completed at the end of the long classification finger, and if a PD is determined to support auto class, an auto class power measurement will be automatically completed after turn on in accordance with the IEEE auto class timing requirements.

备注

An Auto Class power measurement will be completed shortly after power on for all channels that are found to support auto class during classification.

These measurement results are available in registers (0x51h - 0x54h), and the auto class power measurements are provide per individual channel.

9.6.2.25 2-Pair Police Ch-1 Configuration Register

COMMAND = 1Eh with 1 Data Byte, Read/Write

图 9-30. 2-Pair Police Ch-1 Register Format

7	6	5	4	3	2	1	0
POL1_7	POL1_6	POL1_5	POL1_5	POL1_3	POL1_2	POL1_1	POL1_0
R/W-1	R/W-1	R/W-1	R/W-1	R/W-1	R/W-1	R/W-1	R/W1

LEGEND: R/W = Read/Write; R = Read only; -n = value after reset

9.6.2.26 2-Pair Police Ch-2 Configuration Register

COMMAND = 1Fh with 1 Data Byte, Read/Write

图 9-31. 2-Pair Police Ch-2 Register Format

7	6	5	4	3	2	1	0
POL2_7	POL2_6	POL2_5	POL2_4	POL2_3	POL2_2	POL2_1	POL2_0
R/W-1	R/W-1	R/W-1	R/W-1	R/W-1	R/W-1	R/W-1	R/W1

LEGEND: R/W = Read/Write; R = Read only; -n = value after reset

9.6.2.27 2-Pair Police Ch-3 Configuration Register

COMMAND = 20h with 1 Data Byte, Read/Write

图 9-32. 2-Pair Police Ch-3 Register Format

7	6	5	4	3	2	1	0
POL3_7	POL3_6	POL3_5	POL3_5	POL3_3	POL3_2	POL3_1	POL3_0
R/W-1	R/W-1	R/W-1	R/W-1	R/W-1	R/W-1	R/W-1	R/W1

LEGEND: R/W = Read/Write; R = Read only; -n = value after reset

9.6.2.28 2-Pair Police Ch-4 Configuration Register

COMMAND = 21h with 1 Data Byte, Read/Write

图 9-33. 2-Pair Police Ch-4 Register Format

7	6	5	4	3	2	1	0
POL4_7	POL4_6	POL4_5	POL4_4	POL4_3	POL4_2	POL4_1	POL4_0
R/W-1	R/W-1	R/W-1	R/W-1	R/W-1	R/W-1	R/W-1	R/W1

LEGEND: R/W = Read/Write; R = Read only; -n = value after reset

表 9-35. 2-Pair Policing Register Fields Descriptions

Bit	Field	Type	Reset	Description
7 - 0	POLn_7- POLn_0	R/W	1	1-byte defining 2-Pair P _{CUT} minimum threshold. The equation defining the P _{CUT} is: $P_{CUT} = (N \times PC_{STEP})$ Where, when assuming 0.200-Ω R _{sense} resistor is used: $PC_{STEP} = 0.5 W$

备注

These bits set the minimum threshold for the design. Internally, the typical PCUT threshold is set slightly above this value to ensure that the device does not trip a Pcut fault at or below the set value in this register due to part to part or temperature variation.

The contents of this register is reset to 0xFFh anytime the port is turned off or disabled either due to fault condition or user command

备注

Programmed values of less than 2W are not supported. If a value of less than 2W is programmed into these registers, the device will use 2W as the 2-pair Policing value.

Power Policing:

The TPS23882B implements a true Power Policing limit, where the device will adjust the policing limit based on both voltage and current variation in order to ensure a reliable power limit.

In semiauto and auto modes, these bits are automatically set during power on based on the assigned class (see tables below). If an alternative value is desired, it needs to be set after the PEn bit is set in 0x10h, or it may also be configured prior to port turn on in combination with the use of the MPOLn bits in register 0x40 (see [9.6.2.45](#)).

表 9-36. 2-Pair Policing Settings based on the Assigned Class

Assigned Class	POLn7-0 Settings	Minimum Power
Class 1	0000 1000	4W
Class 2	0000 1110	7W
Class 3	0001 1111	15.5W
Class 4	0011 1100	30W

9.6.2.29 Capacitance (Legacy PD) Detection

COMMAND = 22h with 1 Data Byte, Write Only

Used to do enable capacitance measurement from Manual mode

图 9-34. Capacitance Detection Register Format

7	6	5	4	3	2	1	0
-	CDET4	-	CDET3	-	CDET2	-	CDET1
R/W-0	R/W-0	R/W-0	R/W-0	R/W-0	R/W-0	R/W-0	R/W-0

LEGEND: R/W = Read/Write; R = Read only; W = Write only; -n = value after reset

表 9-37. Capacitance Detection Register Field Descriptions

Bit	Field	Type	Reset	Description
7, 5, 3, 1	Reserved	R/W	0	
6, 4, 2, 0	CDETN	R/W	0	Enables Capacitance deflection for channel "n" 0 = Capacitance deflection disabled 1 = Capacitance detection enabled

To complete a capacitance measurement on a channel, the channel must first be placed into diagnostic mode. Set the bits in register 0x22h to enable capacitance detection on the channel(s) desired. Then set the DETE bits in register 0x14h to begin the detection and process.

备注

The TPS23882B SRAM needs to be programmed in order for the capacitance measurement to operate properly.

The capacitance measurement is only supported in Manual/Diagnostic mode.

No capacitance measurement will be made if the result of the resistance detection is returned as "valid".

Upon completion of the capacitance measurement the DETCn bit will be set in register 0x04h, and the resistance and capacitance values will be updated in registers 0x44h - 0x4Bh.

9.6.2.30 Power-on Fault Register

COMMAND = 24h with 1 Data Byte, Read Only

COMMAND = 25h with 1 Data Byte, Clear on Read

图 9-35. Power-on Fault Register Format

7	6	5	4	3	2	1	0
PF4		PF3		PF2		PF1	
R-0	R-0	R-0	R-0	R-0	R-0	R-0	R-0
CR-0	CR-0	CR-0	CR-0	CR-0	CR-0	CR-0	CR-0

LEGEND: R/W = Read/Write; R = Read only; W = Write only; CR = Clear on Read; -n = value after reset

表 9-38. Power-on Fault Register Field Descriptions

Bit	Field	Type	Reset	Description										
7 - 0	PF4 - PF1	R or CR	0	<p>Represents the fault status of the classification and detection for channel n, following a failed turn on attempt with the PWONn command. These bits are cleared when channel n is turned off. PFn: the selection is as follows:</p> <table border="1"> <thead> <tr> <th>Fault Code</th> <th>Power-on Fault Description</th> </tr> </thead> <tbody> <tr> <td>0 0</td> <td>No fault</td> </tr> <tr> <td>0 1</td> <td>Invalid detection</td> </tr> <tr> <td>1 0</td> <td>Classification Error</td> </tr> <tr> <td>1 1</td> <td>Insufficient Power</td> </tr> </tbody> </table>	Fault Code	Power-on Fault Description	0 0	No fault	0 1	Invalid detection	1 0	Classification Error	1 1	Insufficient Power
Fault Code	Power-on Fault Description													
0 0	No fault													
0 1	Invalid detection													
1 0	Classification Error													
1 1	Insufficient Power													

备注

When a Start Fault occurs and the PECn bit is not set, then this register will indicate the cause of the fault.

An insufficient power fault is reported anytime the reg 0x29 configuration will not allow a channel to be powered. See the section describing [节 9.1.5](#).

9.6.2.31 PORT RE-MAPPING Register

COMMAND = 26h with 1 Data Byte, Read/Write

图 9-36. PORT RE-MAPPING Register Format

7		6		5		4		3		2		1		0	
Physical Channel # of Logical Channel 4				Physical Channel # of Logical Channel 3				Physical Channel # of Logical Channel 2				Physical Channel # of Logical Channel 1			
R/W-1		R/W-1		R/W-1		R/W-0		R/W-0		R/W-1		R/W-0		R/W-0	

LEGEND: R/W = Read/Write; R = Read only; W = Write only; CR = Clear on Read; -n = value after reset

表 9-39. PORT RE-MAPPING Register Field Descriptions

Bit	Field	Type	POR / RST	Description															
7 - 0	Physical Channel # of Logical Channel n	R/W	1110 0100b / P	<p>Used to re-map channels logically due to physical board constraints. Re-mapping is between any channel within 4-channel group (1-4 or 5-8). All channels of a group of four must be in OFF mode prior to receiving the port re-mapping command, otherwise the command will be ignored. By default there is no re-mapping.</p> <p>Each pair of bits corresponds to the logical port assigned.</p> <p>The selection per port is as follows:</p> <table border="1" data-bbox="565 835 1177 1045"> <thead> <tr> <th>Re-Map Code</th> <th>Physical Channel</th> <th>Package Pins</th> </tr> </thead> <tbody> <tr> <td>0 0</td> <td>1</td> <td>Drain1, Gat1, Sen1</td> </tr> <tr> <td>0 1</td> <td>2</td> <td>Drain2, Gat2, Sen2</td> </tr> <tr> <td>1 0</td> <td>3</td> <td>Drain3, Gat3, Sen3</td> </tr> <tr> <td>1 1</td> <td>4</td> <td>Drain4, Gat4, Sen4</td> </tr> </tbody> </table> <p>When there is no re-mapping the default value of this register is 1110,0100. The 2 MSbits with a value 11 indicate that logical channel 4 is mapped onto physical channel #4, the next 2 bits, 10, suggest logical channel 3 is mapped onto physical channel #3 and so on.</p> <p>Note: Code duplication is not allowed - that is, the same code cannot be written into the remapping bits of more than one port - if such a value is received, it will be ignored and the chip will stay with existing configuration.</p> <p>Note: Port remapping configuration is kept unchanged if 0x1A IC reset command is received.</p>	Re-Map Code	Physical Channel	Package Pins	0 0	1	Drain1, Gat1, Sen1	0 1	2	Drain2, Gat2, Sen2	1 0	3	Drain3, Gat3, Sen3	1 1	4	Drain4, Gat4, Sen4
Re-Map Code	Physical Channel	Package Pins																	
0 0	1	Drain1, Gat1, Sen1																	
0 1	2	Drain2, Gat2, Sen2																	
1 0	3	Drain3, Gat3, Sen3																	
1 1	4	Drain4, Gat4, Sen4																	

备注

The RST condition of "P" indicates that the previous state of these bits will be preserved following a device reset using the RESET pin. Thus, pulling the RESET input low will not overwrite any user changes to this register.

备注

After port remapping, TI recommends to do at least one detection-classification cycle before turn on.

9.6.2.32 Channels 1 and 2 Multi Bit Priority Register

COMMAND = 27h with 1 Data Byte, Read/Write .

图 9-37. Channels 1 and 2 MBP Register Format

7	6	5	4	3	2	1	0
-	MBP2_2	MBP2_1	MBP2_0	-	MBP1_2	MBP1_1	MBP1_0
R/W-0	R/W-0	R/W-0	R/W-0	R/W-0	R/W-0	R/W-0	R/W - 0

LEGEND: R/W = Read/Write; R = Read only; -n = value after reset

9.6.2.33 Channels 3 and 4 Multi Bit Priority Register

COMMAND = 28h with 1 Data Byte, Read/Write

图 9-38. Channels 3 and 4 MBP Register Format

7	6	5	4	3	2	1	0
-	MBP4_2	MBP4_1	MBP4_0	-	MBP3_2	MBP3_1	MBP3_0
R/W-0	R/W-0	R/W-0	R/W-0	R/W-0	R/W-0	R/W-0	R/W - 0

LEGEND: R/W = Read/Write; R = Read only; -n = value after reset

表 9-40. Channels n MBP Register Field Descriptions

Bit	Field	Type	Reset	Description																																								
7 - 0	MBPn_2-0	R/W	0	<p>MBPn_2-0: Multi Bit Priority bits, three bits per channel, if 3-bit shutdown priority has been selected (MbitPrty in General Mask register is high). It is used to determine which channel(s) is (are) shut down in response to a serial shutdown code received at the OSS shutdown input.</p> <p>The turn off procedure (including register bits clearing) is similar to a channel reset using Reset command (1Ah register), except that it does not cancel any ongoing fault cool down time count.</p> <p>The priority is defined as followings:</p> <p>OSS code \leq MBPn_2-0 : when the OSS code is received, the corresponding channel is powered off.</p> <p>OSS code $>$ MBPn_2-0 : OSS code has no impact on the channel</p> <table border="1" style="margin-left: 20px; border-collapse: collapse; width: 80%;"> <thead> <tr> <th colspan="3">MBPn_2-0 0x27/28 Register</th> <th>Multi Bit Priority</th> <th>OSS Code for Channel Off</th> </tr> </thead> <tbody> <tr> <td>0</td> <td>0</td> <td>0</td> <td>Highest</td> <td>OSS = '000'</td> </tr> <tr> <td>0</td> <td>0</td> <td>1</td> <td>2</td> <td>OSS = '000' or '001'</td> </tr> <tr> <td>0</td> <td>1</td> <td>0</td> <td>3</td> <td>OSS \leq '010'</td> </tr> <tr> <td>0</td> <td>1</td> <td>1</td> <td>4</td> <td>OSS \leq '011'</td> </tr> <tr> <td>1</td> <td>0</td> <td>0</td> <td>4</td> <td>OSS \leq '100'</td> </tr> <tr> <td>1</td> <td>0</td> <td>1</td> <td>6</td> <td>OSS = any code except '111'</td> </tr> <tr> <td>1</td> <td>1</td> <td>1</td> <td>Lowest</td> <td>OSS = any code</td> </tr> </tbody> </table>	MBPn_2-0 0x27/28 Register			Multi Bit Priority	OSS Code for Channel Off	0	0	0	Highest	OSS = '000'	0	0	1	2	OSS = '000' or '001'	0	1	0	3	OSS \leq '010'	0	1	1	4	OSS \leq '011'	1	0	0	4	OSS \leq '100'	1	0	1	6	OSS = any code except '111'	1	1	1	Lowest	OSS = any code
MBPn_2-0 0x27/28 Register			Multi Bit Priority	OSS Code for Channel Off																																								
0	0	0	Highest	OSS = '000'																																								
0	0	1	2	OSS = '000' or '001'																																								
0	1	0	3	OSS \leq '010'																																								
0	1	1	4	OSS \leq '011'																																								
1	0	0	4	OSS \leq '100'																																								
1	0	1	6	OSS = any code except '111'																																								
1	1	1	Lowest	OSS = any code																																								

The priority reduces as the 3-bit value increases. Thus, a channel with a "000" setting has the highest priority, while one with a "111" setting has the lowest.

It is permissible to apply the same settings to multiple channels. Doing so will result in all channels with the same setting will be disabled when the appropriate OSS code is presented.

The turn off procedure due to OSS is similar to a channel reset or change to OFF mode, with the exception that OSS does not cancel any ongoing fault cool down timers. the table below includes the bits that will be cleared when a channel is disabled due to OSS:

表 9-41. Channel Turn Off with MBP OSS

Register	Bits to be Reset
0x04	CLSCn and DETCn
0x06	DISFn and PCUTn
0x08	STRn and ILIMn
0x0C-0F	Requested Class and Detection
0x10	PGn and PEn
0x14	CLEn and DETEn
0x1C	ACn
0x1E-21	2P Policing set to 0xFFh
0x24	PFn
0x30-3F	Channel Voltage and Current Measurements
0x40	2xFBn
0x44 - 47	Detection Resistance Measurements
0x4C-4F	Assigned Class and Previous Class
0x51-54	Autoclass Measurement

备注

There is no memory of any preceding 3-bit OSS commands. Each 3-bit OSS command is processed immediately (prior to the end of the last OSS MBP pulse) based on the MBPn settings for each Channel. Any attempt to shutdown additional Channels thereafter will require additional 3-bit OSS commands.

9.6.2.34 Port Power Allocation Register

COMMAND = 29h with 1 Data Byte, Read/Write

图 9-39. Power Allocation Register Format

7	6	5	4	3	2	1	0
Rsvrd	MC34_2	MC34_1	MC34_0	Rsvrd	MC12_2	MC12_1	MC12_0
R/W-0	R/W-0	R/W-0	R/W-0	R/W-0	R/W-0	R/W-0	R/W - 0

LEGEND: R/W = Read/Write; R = Read only; -n = value after reset

表 9-42. Power Allocation Register Field Descriptions

Bit	Field	Type	Reset	Description
7, 3	Rsvrd	R/W	0	Reserved
6 - 4, 2 - 0	MCnn_2-0	R/W	0	MCnn_2-0: Port Power Allocation bits. These bits set the maximum power classification level that a given channel is allowed to power on In semiauto mode these bits need to be set prior to issuing a PWONn command, while in auto mode these bits need to be set prior to setting the DETE and CLE bits in 0x14.

表 9-43. Power Allocation Settings

MCnn_2	MCnn_1	MCnn_0	Power Allocation
0	0	0	2-Pair 15.4W
0	0	1	2-Pair 4 W
0	1	0	2-Pair 7 W
0	1	1	2-Pair 30W
1	x	x	Reserved

备注

The Power Allocation (0x29h) value needs to be set prior to issuing a PWON command in semiauto or auto modes, and prior to setting the DETE and CLE bits in auto mode. Any changes to the Power Allocation value after a PWON command is given may be ignored.

备注

For 2-Pair wired ports, the MCnn_2-0 bits set the power allocation settings for both channels 1 and 2 and 3 and 4 concurrently.

It is possible to have channels 3 and 4 set to 15.4W while channels 1 and 2 are set to 30W, but it is not possible to have different power allocation settings between channels 1 and 2 or 3 and 4

备注

Setting register 0x29 to the 4 W Power Allocation configuration will only allow Class 1 PDs to be powered. Attempts to power any other class PDs will result in an insufficient power fault

Setting register 0x29 to the 7 W Power Allocation configuration will only allow Class 1 & 2 PDs to be powered. Attempts to power a class 3 or 4+ PDs will result in an insufficient power fault

9.6.2.35 TEMPERATURE Register

COMMAND = 2Ch with 1 Data Byte, Read Only

图 9-40. TEMPERATURE Register Format

7	6	5	4	3	2	1	0
TEMP7	TEMP6	TEMP5	TEMP4	TEMP3	TEMP2	TEMP1	TEMP0
R-0	R-0	R-0	R-0	R-0	R-0	R-0	R-0

LEGEND: R/W = Read/Write; R = Read only; -n = value after reset

表 9-44. TEMPERATURE Register Field Descriptions

Bit	Field	Type	Reset	Description						
7 - 0	TEMP7 - TEMP0	R	0	<p>Bit Descriptions: Data conversion result. The I²C data transmission is a 1-byte transfer. 8-bit Data conversion result of temperature, from -20°C to 125°C. The update rate is around once per second.</p> <p>The equation defining the temperature measured is:</p> $T = -20 + N \times T_{STEP}$ <p>Where T_{STEP} is defined below as well as the full scale value:</p> <table border="1" data-bbox="659 831 1200 907"> <thead> <tr> <th>Mode</th> <th>Full Scale Value</th> <th>T_{STEP}</th> </tr> </thead> <tbody> <tr> <td>Any</td> <td>146.2°C</td> <td>0.652°C</td> </tr> </tbody> </table>	Mode	Full Scale Value	T _{STEP}	Any	146.2°C	0.652°C
Mode	Full Scale Value	T _{STEP}								
Any	146.2°C	0.652°C								

9.6.2.36 INPUT VOLTAGE Register

COMMAND = 2Eh with 2 Data Byte (LSByte first, MSByte second), Read only

图 9-41. INPUT VOLTAGE Register Format

7	6	5	4	3	2	1	0
LSB:							
VPWR7	VPWR6	VPWR5	VPWR4	VPWR3	VPWR2	VPWR1	VPWR0
R-0	R-0	R-0	R-0	R-0	R-0	R-0	R-0
MSB:							
-	-	VPWR13	VPWR12	VPWR11	VPWR10	VPWR9	VPWR8
R-0	R-0	R-0	R-0	R-0	R-0	R-0	R-0

LEGEND: R/W = Read/Write; R = Read only; -n = value after reset

表 9-45. INPUT VOLTAGE Register Field Descriptions

Bit	Field	Type	Reset	Description						
13 - 0	VPWR13- VPWR0	R	0	<p>Bit Descriptions: Data conversion result. The I²C data transmission is a 2-byte transfer. 14-bit Data conversion result of input voltage.</p> <p>The equation defining the voltage measured is:</p> $V = N \times V_{STEP}$ <p>Where V_{STEP} is defined below as well as the full scale value:</p> <table border="1" style="margin-left: auto; margin-right: auto; border-collapse: collapse;"> <thead> <tr> <th style="width: 15%;">Mode</th> <th style="width: 35%;">Full Scale Value</th> <th style="width: 50%;">V_{STEP}</th> </tr> </thead> <tbody> <tr> <td style="text-align: center;">Any</td> <td style="text-align: center;">60 V</td> <td style="text-align: center;">3.662 mV</td> </tr> </tbody> </table> <p>Note that the measurement is made between VPWR and AGND.</p>	Mode	Full Scale Value	V _{STEP}	Any	60 V	3.662 mV
Mode	Full Scale Value	V _{STEP}								
Any	60 V	3.662 mV								

9.6.2.37 CHANNEL 1 CURRENT Register

COMMAND = 30h with 2 Data Byte, (LSByte First, MSByte second), Read Only

图 9-42. CHANNEL 1 CURRENT Register Format

7	6	5	4	3	2	1	0
LSB:							
I1_7	I1_6	I1_5	I1_4	I1_3	I1_2	I1_1	I1_0
R-0	R-0	R-0	R-0	R-0	R-0	R-0	R-0
MSB:							
-	-	I1_13	I1_12	I1_11	I1_10	I1_9	I1_8
R-0	R-0	R-0	R-0	R-0	R-0	R-0	R-0

LEGEND: R/W = Read/Write; R = Read only; -n = value after reset

9.6.2.38 CHANNEL 2 CURRENT Register

COMMAND = 34h with 2 Data Byte, (LSByte First, MSByte second), Read Only

图 9-43. CHANNEL 2 CURRENT Register Format

7	6	5	4	3	2	1	0
LSB:							
I2_7	I2_6	I2_5	I2_4	I2_3	I2_2	I2_1	I2_0
R-0	R-0	R-0	R-0	R-0	R-0	R-0	R-0
MSB:							
-	-	I2_13	I2_12	I2_11	I2_10	I2_9	I2_8
R-0	R-0	R-0	R-0	R-0	R-0	R-0	R-0

LEGEND: R/W = Read/Write; R = Read only; -n = value after reset

9.6.2.39 CHANNEL 3 CURRENT Register

COMMAND = 38h with 2 Data Byte, (LSByte First, MSByte second), Read Only

图 9-44. CHANNEL 3 CURRENT Register Format

7	6	5	4	3	2	1	0
LSB:							
I3_7	I3_6	I3_5	I3_4	I3_3	I3_2	I3_1	I3_0
R-0	R-0	R-0	R-0	R-0	R-0	R-0	R-0
MSB:							
-	-	I3_13	I3_12	I3_11	I3_10	I3_9	I3_8
R-0	R-0	R-0	R-0	R-0	R-0	R-0	R-0

LEGEND: R/W = Read/Write; R = Read only; -n = value after reset

9.6.2.40 CHANNEL 4 CURRENT Register

COMMAND = 3Ch with 2 Data Byte, (LSByte First, MSByte second), Read Only

图 9-45. CHANNEL 4 CURRENT Register Format

7	6	5	4	3	2	1	0
LSB:							
I4_7	I4_6	I4_5	I4_4	I4_3	I4_2	I4_1	I4_0
R-0	R-0	R-0	R-0	R-0	R-0	R-0	R-0

图 9-45. CHANNEL 4 CURRENT Register Format (continued)

MSB:							
-	-	I4_13	I4_12	I4_11	I4_10	I4_9	I4_8
R-0	R-0	R-0	R-0	R-0	R-0	R-0	R-0

LEGEND: R/W = Read/Write; R = Read only; -n = value after reset

表 9-46. CHANNEL n CURRENT Register Field Descriptions

Bit	Field	Type	Reset	Description						
13-0	In_13- In_0	R	0	<p>Bit Descriptions: Data conversion result. The I²C data transmission is a 2-byte transfer. Note that the conversion is done using a TI proprietary multi-slope integrating converter. 14-bit Data conversion result of current for channel n. The update rate is around once per 100 ms in powered state.</p> <p>The equation defining the current measured is:</p> $I = N \times I_{STEP}$ <p>Where I_{STEP} is defined below as well as the full scale value, according to the operating mode:</p> <table border="1" style="margin-left: 20px;"> <thead> <tr> <th>Mode</th> <th>Full Scale Value</th> <th>I_{STEP}</th> </tr> </thead> <tbody> <tr> <td>Powered and Classification</td> <td>1.46 A (with 0.2-Ω Rsense)</td> <td>89.5 μA</td> </tr> </tbody> </table> <p>Note: in any of the following cases, the result through I²C interface is automatically 0000</p> <ul style="list-style-type: none"> channel is in OFF mode channel is OFF while in semiauto mode and detect/class is not enabled channel is OFF while in semiauto mode and detection result is incorrect <p>In diagnostic/manual mode, if detect/class has been enabled at least once, the register retains the result of the last measurement</p>	Mode	Full Scale Value	I _{STEP}	Powered and Classification	1.46 A (with 0.2-Ω Rsense)	89.5 μA
Mode	Full Scale Value	I _{STEP}								
Powered and Classification	1.46 A (with 0.2-Ω Rsense)	89.5 μA								

备注

1.46A is the theoretical full scale range of the ADC based on 14bits * Istep. However, due to the 1.25A channel current limit, the channel current will foldback and be disabled when the current exceeds the ILIM-2X threshold (V_{LIM2X}).

Class Current Reading

Following the completion of any classification measurement on a channel, the measured classification current is reported in these registers until either a port current reading is completed following a port turn on or the port is disabled.

备注

The scaling factor for the class current reading is decreased by a factor of 10x to 8.95uA/bit.

9.6.2.41 CHANNEL 1 VOLTAGE Register

COMMAND = 32h with 2 Data Byte, (LSByte First, MSByte second), Read Only

图 9-46. CHANNEL 1 VOLTAGE Register Format

7	6	5	4	3	2	1	0
LSB:							
V1_7	V1_6	V1_5	V1_4	V1_3	V1_2	V1_1	V1_0
R-0	R-0	R-0	R-0	R-0	R-0	R-0	R-0
MSB:							
-	-	V1_13	V1_12	V1_11	V1_10	V1_9	V1_8
R-0	R-0	R-0	R-0	R-0	R-0	R-0	R-0

LEGEND: R/W = Read/Write; R = Read only; -n = value after reset

9.6.2.42 CHANNEL 2 VOLTAGE Register

COMMAND = 36h with 2 Data Byte, (LSByte First, MSByte second), Read Only

图 9-47. CHANNEL 2 VOLTAGE Register Format

7	6	5	4	3	2	1	0
LSB:							
V2_7	V2_6	V2_5	V2_4	V2_3	V2_2	V2_1	V2_0
R-0	R-0	R-0	R-0	R-0	R-0	R-0	R-0
MSB:							
-	-	V2_13	V2_12	V2_11	V2_10	V2_9	V2_8
R-0	R-0	R-0	R-0	R-0	R-0	R-0	R-0

LEGEND: R/W = Read/Write; R = Read only; -n = value after reset

9.6.2.43 CHANNEL 3 VOLTAGE Register

COMMAND = 3Ah with 2 Data Byte, (LSByte First, MSByte second), Read Only

图 9-48. CHANNEL 3 VOLTAGE Register Format

7	6	5	4	3	2	1	0
LSB:							
V3_7	V3_6	V3_5	V3_4	V3_3	V3_2	V3_1	V3_0
R-0	R-0	R-0	R-0	R-0	R-0	R-0	R-0
MSB:							
-	-	V3_13	V3_12	V3_11	V3_10	V3_9	V3_8
R-0	R-0	R-0	R-0	R-0	R-0	R-0	R-0

LEGEND: R/W = Read/Write; R = Read only; -n = value after reset

9.6.2.44 CHANNEL 4 VOLTAGE Register

COMMAND = 3Eh with 2 Data Byte, (LSByte First, MSByte second), Read Only

图 9-49. CHANNEL 4 VOLTAGE Register Format

7	6	5	4	3	2	1	0
LSB:							
V4_7	V4_6	V4_5	V4_4	V4_3	V4_2	V4_1	V4_0
R-0	R-0	R-0	R-0	R-0	R-0	R-0	R-0

图 9-49. CHANNEL 4 VOLTAGE Register Format (continued)

MSB:							
-	-	V4_13	V4_12	V4_11	V4_10	V4_9	V4_8
R-0	R-0	R-0	R-0	R-0	R-0	R-0	R-0

LEGEND: R/W = Read/Write; R = Read only; -n = value after reset

表 9-47. CHANNEL n VOLTAGE Register Field Descriptions

Bit	Field	Type	Reset	Description						
13-0	Vn_13- Vn_0	R	0	Bit Descriptions: Data conversion result. The I ² C data transmission is a 2-byte transfer. The equation defining the voltage measured is: $V = N \times V_{STEP}$ Where V _{STEP} is defined below as well as the full scale value: <table border="1" style="margin: 10px auto; border-collapse: collapse;"> <thead> <tr> <th style="text-align: center;">Mode</th> <th style="text-align: center;">Full Scale Value</th> <th style="text-align: center;">V_{STEP}</th> </tr> </thead> <tbody> <tr> <td style="text-align: center;">Powered</td> <td style="text-align: center;">60 V</td> <td style="text-align: center;">3.662 mV</td> </tr> </tbody> </table> Note that a powered voltage measurement is made between VPWR and DRAINn. Note: if a channel is OFF, the result through I ² C interface is automatically 0000.	Mode	Full Scale Value	V _{STEP}	Powered	60 V	3.662 mV
Mode	Full Scale Value	V _{STEP}								
Powered	60 V	3.662 mV								

9.6.2.45 2x FOLDBACK SELECTION Register

COMMAND = 40h with 1 Data Byte Read/Write

图 9-50. 2x FOLDBACK SELECTION Register Format

7	6	5	4	3	2	1	0
2xFB4	2xFB3	2xFB2	2xFB1	MPOL4	MPOL3	MPOL2	MPOL1
R/W-0	R/W-0	R/W-0	R/W-0	R/W-0	R/W-0	R/W-0	R/W-0

LEGEND: R/W = Read/Write; R = Read only; -n = value after reset

表 9-48. 2x FOLDBACK SELECTION Register Field Descriptions

Bit	Field	Type	Reset	Description
7 - 4	2xFB4- 2xFB1	R/W	0	When set, this activates the 2x Foldback mode for a channel which increases its I_{LIM} and I_{SHORT} levels normal settings, as shown in 图 9-3. Note that the fault timer starts when the I_{LIM} threshold is exceeded. Notes: 1) At turn on, the inrush current profile is unaffected by these bits, as shown in 图 9-2. 2) When a 2xFBn bit is deasserted, the t_{LIM} setting used for the associated channel is always the nominal value (approximately 60 ms). If 2xFBn bit is asserted, then t_{LIM} for associated channel is programmable as defined in the Timing Configuration register (0x16). 3) If the assigned class for a channel is class 4 or above, the 2xFB bit will be automatically set during turn on.
3-0	MPOL4 - MPOL1	R/W	0	Manual Policing and Foldback configuration bits 0 = The internal device firmware automatically adjusts the Policing (P_{CUT}) and 2xFBn settings based on the assigned class during port turn on 1 = The Policing (P_{CUT}) and 2xFBn settings will not be changed during port turn on. Note: Independent of these settings, the Policing (P_{CUT}) and 2xFBn settings are returned to their default values upon port turn off. Note: Setting either bit for a 4P configured port disables the automatic configuration on both channels The MPOLn bits are cleared upon port turn off.

备注

Refer to register 0x55h description for more information on additional Foldback and Inrush configuration options



图 9-51. 1x Mode (2xFBn = 0) Foldback Curves, I_{PORT} vs V_{DRAIN}



图 9-52. 2x Mode (2xFBn = 1) Foldback Curves, I_{PORT} vs V_{DRAIN}

9.6.2.46 FIRMWARE REVISION Register

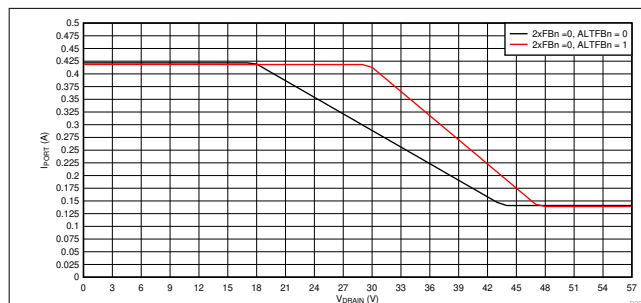
COMMAND = 41h with 1 Data Byte, Read Only

图 9-53. FIRMWARE REVISION Register Format

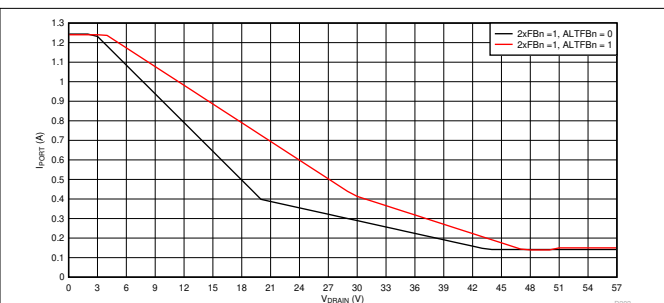
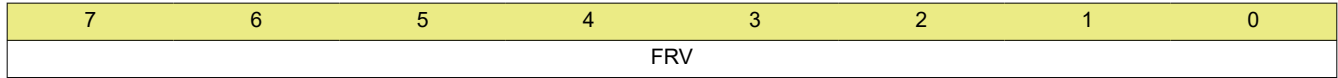

LEGEND: R/W = Read/Write; R = Read only; -n = value after reset

表 9-49. FIRMWARE REVISION Register Field Descriptions

Bit	Field	Type	Reset	Description
7 - 0	FRV	R		Firmware Revision number

After a RESET or POR fault this value will default to 0000, 0000b, but upon a “valid” SRAM load, this value will reflect the corresponding SRAM version of firmware (0x01h - 0xFEh).

备注

If the value of this register = 0xFFh, the device is running in “safe mode”, and the SRAM needs to be reprogrammed to resume normal operation.

9.6.2.47 I2C WATCHDOG Register

COMMAND = 42h with 1 Data Byte, Read/Write

The I²C watchdog timer monitors the I²C clock line in order to prevent hung software situations that could leave ports in a hazardous state. The timer can be reset by either edge on SCL input. If the watchdog timer expires, all channels will be turned off and WDS bit will be set. The nominal watchdog time-out period is 2 seconds.

图 9-54. I2C WATCHDOG Register Format

7	6	5	4	3	2	1	0
-	-	-	IWDD3	IWDD2	IWDD1	IWDD0	WDS
-	-	-	R/W-1	R/W-0	R/W-1	R/W-1	R/W-0

LEGEND: R/W = Read/Write; R = Read only; -n = value after reset

表 9-50. I2C WATCHDOG Register Field Descriptions

Bit	Field	Type	Reset	Description
4 - 1	IWDD3 - IWDD0	R/W	1011b	I ² C Watchdog disable. When equal to 1011b, the watchdog is masked. Otherwise, it is unmasked and the watchdog is operational.
0	WDS	R/W	0	I ² C Watchdog timer status, valid even if the watchdog is masked. When set, it means that the watchdog timer has expired without any activity on I ² C clock line. Writing 0 at WDS location clears it. Note that when the watchdog timer expires and if the watchdog is unmasked, all channels are also turned off.

When the channels are turned OFF due to I²C watchdog, the corresponding bits are also cleared:

表 9-51. I2C WATCHDOG Reset

Register	Bits to be Reset
0x04	CLSCn and DETCn
0x06	DISFn and PCUTn
0x08	STRn and ILIMn
0x0C-0F	Requested Class and Detection
0x10	PGn and PEn
0x14	CLEn and DETEn
0x1C	ACn
0x1E-21	2P Policing set to 0xFFh
0x24	PFn
0x30-3F	Channel Voltage and Current Measurements
0x40	2xFBn
0x44 - 47	Detection Resistance Measurements
0x4C-4F	Assigned Class and Previous Class
0x51-54	Autoclass Measurement

The corresponding PGCn and PECn bits of Power Event register will also be set if there is a change. The corresponding PEn and PGn bits of Power Status Register are also updated accordingly.

备注

If the I²C watchdog timer has expired, the Temperature and Input voltage registers will stop being updated until the WDS bit is cleared. The WDS bit must then be cleared to allow these registers to work normally.

9.6.2.48 DEVICE ID Register

COMMAND = 43h with 1 Data Byte, Read Only

图 9-55. DEVICE ID Register Format

7	6	5	4	3	2	1	0
DID				SR			

LEGEND: R/W = Read/Write; R = Read only; -n = value after reset

表 9-52. DEVICE ID Register Field Descriptions

Bit	Field	Type	Reset	Description
7 - 5	DID	R	0011b	Device ID number
4 - 0	SR	R	0100b	Silicon Revision number

9.6.2.49 CHANNEL 1 DETECT RESISTANCE Register

COMMAND = 44h with 1 Data Byte, Read Only

图 9-56. CHANNEL 1 DETECT RESISTANCE Register Format

7	6	5	4	3	2	1	0
R1_7	R1_6	R1_5	R1_4	R1_3	R1_2	R1_1	R1_0
R-0	R-0	R-0	R-0	R-0	R-0	R-0	R-0

LEGEND: R/W = Read/Write; R = Read only; -n = value after reset

9.6.2.50 CHANNEL 2 DETECT RESISTANCE Register

COMMAND = 45h with 1 Data Byte, Read Only

图 9-57. CHANNEL 2 DETECT RESISTANCE Register Format

7	6	5	4	3	2	1	0
R2_7	R2_6	R2_5	R2_4	R2_3	R2_2	R2_1	R2_0
R-0	R-0	R-0	R-0	R-0	R-0	R-0	R-0

LEGEND: R/W = Read/Write; R = Read only; -n = value after reset

9.6.2.51 CHANNEL 3 DETECT RESISTANCE Register

COMMAND = 46h with 1 Data Byte, Read Only

图 9-58. CHANNEL 3 DETECT RESISTANCE Register Format

7	6	5	4	3	2	1	0
R3_7	R3_6	R3_5	R3_4	R3_3	R3_2	R3_1	R3_0
R-0	R-0	R-0	R-0	R-0	R-0	R-0	R-0

LEGEND: R/W = Read/Write; R = Read only; -n = value after reset

9.6.2.52 CHANNEL 4 DETECT RESISTANCE Register

COMMAND = 47h with 1 Data Byte, Read Only

图 9-59. CHANNEL 4 DETECT RESISTANCE Register Format

7	6	5	4	3	2	1	0
R4_7	R4_6	R4_5	R4_4	R4_3	R4_2	R4_1	R4_0
R-0	R-0	R-0	R-0	R-0	R-0	R-0	R-0

LEGEND: R/W = Read/Write; R = Read only; -n = value after reset

表 9-53. DETECT RESISTANCE Register Fields Descriptions

Bit	Field	Type	Reset	Description				
7-0	Rn_7- Rn_0	R	0	8-bit data conversion result of detection resistance for channel n. Most recent 2-point Detection Resistance measurement result. The I ² C data transmission is a 1-byte transfer. Note that the register content is not cleared at turn off. The equation defining the resistance measured is: $R = N \times R_{STEP}$ Where R _{STEP} is defined below as well as the full scale value: <table border="1" data-bbox="597 1814 1117 1885"> <thead> <tr> <th>Useable Resistance Range</th> <th>R_{STEP}</th> </tr> </thead> <tbody> <tr> <td>2 kΩ to 50 kΩ</td> <td>195.3125 Ω</td> </tr> </tbody> </table>	Useable Resistance Range	R _{STEP}	2 k Ω to 50 k Ω	195.3125 Ω
Useable Resistance Range	R _{STEP}							
2 k Ω to 50 k Ω	195.3125 Ω							

9.6.2.53 CHANNEL 1 DETECT CAPACITANCE Register

COMMAND = 48h with 1 Data Byte, Read Only

图 9-60. CHANNEL 1 DETECT CAPACITANCE Register Format

7	6	5	4	3	2	1	0
C1_7	C1_6	C1_5	C1_4	C1_3	C1_2	C1_1	C1_0
R-0	R-0	R-0	R-0	R-0	R-0	R-0	R-0

LEGEND: R/W = Read/Write; R = Read only; -n = value after reset

9.6.2.54 CHANNEL 2 DETECT CAPACITANCE Register

COMMAND = 49h with 1 Data Byte, Read Only

图 9-61. CHANNEL 2 DETECT CAPACITANCE Register Format

7	6	5	4	3	2	1	0
C2_7	C2_6	C2_5	C2_4	C2_3	C2_2	C2_1	C2_0
R-0	R-0	R-0	R-0	R-0	R-0	R-0	R-0

LEGEND: R/W = Read/Write; R = Read only; -n = value after reset

9.6.2.55 CHANNEL 3 DETECT CAPACITANCE Register

COMMAND = 4Ah with 1 Data Byte, Read Only

图 9-62. CHANNEL 3 DETECT CAPACITANCE Register Format

7	6	5	4	3	2	1	0
C3_7	C3_6	C3_5	C3_4	C3_3	C3_2	C3_1	C3_0
R-0	R-0	R-0	R-0	R-0	R-0	R-0	R-0

LEGEND: R/W = Read/Write; R = Read only; -n = value after reset

9.6.2.56 CHANNEL 4 DETECT CAPACITANCE Register

COMMAND = 4Bh with 1 Data Byte, Read Only

图 9-63. CHANNEL 4 DETECT CAPACITANCE Register Format

7	6	5	4	3	2	1	0
C4_7	C4_6	C4_5	C4_4	C4_3	R4_2C	C4_1	C4_0
R-0	R-0	R-0	R-0	R-0	R-0	R-0	R-0

LEGEND: R/W = Read/Write; R = Read only; -n = value after reset

表 9-54. DETECT CAPACITANCE Register Fields Descriptions

Bit	Field	Type	Reset	Description				
7-0	Cn_7- Cn_0	R	0	<p>8-bit data conversion result of capacitance measurement for channel n. Most recent capacitance measurement result. The I²C data transmission is a 1-byte transfer. The equation defining the resistance measured is:</p> $C = N \times C_{STEP}$ <p>Where C_{STEP} is defined below as well as the full scale value:</p> <table border="1" data-bbox="597 464 1117 537"> <thead> <tr> <th>Useable Resistance Range</th> <th>C_{STEP}</th> </tr> </thead> <tbody> <tr> <td>1 μF to 12 μF</td> <td>0.05 μF</td> </tr> </tbody> </table> <p>Note that the register content is not cleared at turn off. Note: The capacitance measurement is only supported in Manual/Diagnostic mode. Note: No capacitance measurement will be made if the result of the resistance detection is returned as "valid". Note: The TPS23882B SRAM needs to be programmed in order for the capacitance measurement to operate properly.</p>	Useable Resistance Range	C _{STEP}	1 μF to 12 μF	0.05 μF
Useable Resistance Range	C _{STEP}							
1 μF to 12 μF	0.05 μF							

9.6.2.57 CHANNEL 1 ASSIGNED CLASS Register

COMMAND = 4Ch with 1 Data Byte, Read Only

图 9-64. CHANNEL 1 ASSIGNED CLASS Register Format

7	6	5	4	3	2	1	0
AClass Ch1				PClass Ch1			
R-0	R-0	R-0	R-0	R-0	R-0	R-0	R-0

LEGEND: R/W = Read/Write; R = Read only; -n = value after reset

9.6.2.58 CHANNEL 2 ASSIGNED CLASS Register

COMMAND = 4Dh with 1 Data Byte, Read Only

图 9-65. CHANNEL 2 ASSIGNED CLASS Register Format

7	6	5	4	3	2	1	0
AClass Ch2				PClass Ch2			
R-0	R-0	R-0	R-0	R-0	R-0	R-0	R-0

LEGEND: R/W = Read/Write; R = Read only; -n = value after reset

9.6.2.59 CHANNEL 3 ASSIGNED CLASS Register

COMMAND = 4Eh with 1 Data Byte, Read Only

图 9-66. CHANNEL 3 ASSIGNED CLASS Register Format

7	6	5	4	3	2	1	0
AClass Ch3				PClass Ch3			
R-0	R-0	R-0	R-0	R-0	R-0	R-0	R-0

LEGEND: R/W = Read/Write; R = Read only; -n = value after reset

9.6.2.60 CHANNEL 4 ASSIGNED CLASS Register

COMMAND = 4Fh with 1 Data Byte, Read Only

图 9-67. CHANNEL 4 ASSIGNED CLASS Register Format

7	6	5	4	3	2	1	0
AClass Ch4				PClass Ch4			
R-0	R-0	R-0	R-0	R-0	R-0	R-0	R-0

LEGEND: R/W = Read/Write; R = Read only; -n = value after reset

Bit Descriptions: These bits represent the "assigned" and previous classification results for channel n. These bits are cleared when channel n is turned off.

表 9-55. CHANNEL n ASSIGNED CLASS Register Field Descriptions

Bit	Field	Type	Reset	Description
7 - 4	AClass Ch-n	R	0	Assigned classification on channel n. See 表 9-56 below
3 - 0	PClass Ch-n	R	0	Previous Class result on channel n. See 表 9-57 below

表 9-56. Assigned Class Designations

AClass-Chn				Assigned Class
Bit 7	Bit 6	Bit 5	Bit 4	
0	0	0	0	Unknown
0	0	0	1	Class 1
0	0	1	0	Class 2
0	0	1	1	Class 3
0	1	0	0	Class 4
0	1	0	1	Reserved
0	1	1	0	Reserved
0	1	1	1	Reserved
1	X	X	X	Reserved

表 9-57. Previous Class Designations

PClass-Chn				Previous Class
Bit 7	Bit 6	Bit 5	Bit 4	
0	0	0	0	Unknown
0	0	0	1	Class 1
0	0	1	0	Class 2
0	0	1	1	Class 3
0	1	0	0	Class 4
0	1	0	1	Reserved
0	1	1	0	Class 0
0	1	1	1	Reserved
1	0	0	0	Class 5 - 4-Pair
1	0	0	1	Class 6 - 4-Pair
1	0	1	0	Class 7 - 4-Pair
1	0	1	1	Class 8 - 4-Pair
1	1	X	X	Reserved

“Requested” vs. “Assigned” Classification:

The “requested” class is the classification the PSE measures during Mutual Identification prior to turn on, whereas the “assigned” class is the classification level the Channel was powered on with based on the Power Allocation setting in register 0x29h. The “requested” classification values are available in registers 0x0C-0F

备注

Upon being powered, devices that present a class 0 signature during discovery will be given an assigned class of "Class 3"

备注

There is no Assigned Class assigned for ports/channels powered out of Manual/Diagnostic mode. Any settings such as the port power policing and 1x/2x foldback selection that are typically configure based on the assigned class result need to manually configured by the user.

Previous Classification

In certain circumstances the requested class result in 0x0C-0F can not properly reflect the actual classification of the PD connected to the port/channel. This will happen when a port has a power allocation limit of 15.4W and the PSE can only provide 1 classification finger during turn on. When this occurs and if the device is configured to run in semiauto mode with det and cls enabled, the 3-finger classification measurement that preceded the turn on detection and classification cycle will be stored here. This information can be useful in scenarios where a port had to be demoted to stay under the system power limit at turn on but additional power budget comes available later on.

备注

The Previous Classification results are only valid for channels being used in semiauto mode with ongoing discovery (DETE and CLE = 1).

9.6.2.61 AUTO CLASS CONTROL Register

COMMAND = 50h with 1 Data Byte, Read/Write

图 9-68. AUTO CLASS CONTROL Register Format

7	6	5	4	3	2	1	0
MAC4	MAC3	MAC2	MAC1	AAC4	AAC3	AAC2	AAC1
R/W-0	R/W-0	R/W-0	R/W-0	R/W-0	R/W-0	R/W-0	R/W-0

LEGEND: R/W = Read/Write; R = Read only; -n = value after reset

表 9-58. AUTO CLASS CONTROL Register Field Descriptions

Bit	Field	Type	Reset	Description
7 - 4	MACn	R/W	0	Manual Auto Class Measurement bits 1 = Manual Auto Class Measurement enabled 0 = Manual Auto Class measurement complete The auto class measurement will begin within 10ms of this bit being set. This bit will be cleared by the internal firmware within 1ms of the updated Autoclass measurement result(s) in 0x51-54h.
3 - 0	AACn	R/W	0	Auto Class Auto Adjustment Enable bits 1 = Autoclass auto adjust is enabled and the corresponding PCUT settings will be automatically adjusted based on the measured autoclass power 0 = Autoclass auto adjust is disabled and it is up to the user to adjust the value of PCUT as desired.

备注

Any MACn bits set prior to turn on will be ignored and cleared during turn on.

Auto Class Pcut Adjustments:

If the ACx bit(s) are set in register 0x50h, the TPS23882B will automatically adjust its PCUT value based on the auto class power measurement (P_{AC} in registers 0x51-54) and Any Automatic Auto Class facilitated (AACn = 1) PCut adjustments will be made within 5 ms of the end of the auto class measurement period.

9.6.2.62 CHANNEL 1 AUTO CLASS POWER Register

COMMAND = 51h with 1 Data Byte, Read Only

图 9-69. CHANNEL 1 AUTO CLASS POWER Register Format

7	6	5	4	3	2	1	0
-	PAC1_6	PAC1_5	PAC1_4	PAC1_3	PAC1_2	PAC1_1	PAC1_0
R-0	R-0	R-0	R-0	R-0	R-0	R-0	R-0

LEGEND: R/W = Read/Write; R = Read only; -n = value after reset

9.6.2.63 CHANNEL 2 AUTO CLASS POWER Register

COMMAND = 52h with 1 Data Byte, Read Only

图 9-70. CHANNEL 2 AUTO CLASS POWER Register Format

7	6	5	4	3	2	1	0
-	PAC2_6	PAC2_5	PAC2_4	PAC2_3	PAC2_2	PAC2_1	PAC2_0
R-0	R-0	R-0	R-0	R-0	R-0	R-0	R-0

LEGEND: R/W = Read/Write; R = Read only; -n = value after reset

9.6.2.64 CHANNEL 3 AUTO CLASS POWER Register

COMMAND = 53h with 1 Data Byte, Read Only

图 9-71. CHANNEL 3 AUTO CLASS POWER Register Format

7	6	5	4	3	2	1	0
-	PAC3_6	PAC3_5	PAC3_4	PAC3_3	PAC3_2	PAC3_1	PAC3_0
R-0	R-0	R-0	R-0	R-0	R-0	R-0	R-0

LEGEND: R/W = Read/Write; R = Read only; -n = value after reset

9.6.2.65 CHANNEL 4 AUTO CLASS POWER Register

COMMAND = 54h with 1 Data Byte, Read Only

图 9-72. CHANNEL 4 AUTO CLASS POWER Register Format

7	6	5	4	3	2	1	0
-	PAC4_6	PAC4_5	PAC4_4	PAC4_3	PAC4_2	PAC4_1	PAC4_0
R-0	R-0	R-0	R-0	R-0	R-0	R-0	R-0

LEGEND: R/W = Read/Write; R = Read only; -n = value after reset

表 9-59. AUTO CLASS POWER Register Fields Descriptions

Bit	Field	Type	Reset	Description
6-0	PACn_6- PACn_0	R	0	8-bit data conversion result of the auto class power measurement for channel n. Peak average power calculation result from channel voltage and current data conversion measurements taken during the auto class power measurement window. The equation defining the auto class power measured is: $P_{AC} = N \times P_{AC_STEP}$ Where, when assuming 0.200-Ω Rsense resistor is used: $P_{CSTEP} = 0.5 \text{ W}$

9.6.2.66 ALTERNATIVE FOLDBACK Register

COMMAND = 55h with 1 Data Byte, Read/Write

图 9-73. ALTERNATIVE FOLDBACK Register Format

7	6	5	4	3	2	1	0
ALTFB4	ALTFB3	ALTFB2	ALTFB1	ALTIR4	ALTIR3	ALTIR2	ALTIR1
R/W-0	R/W-0	R/W-0	R/W-0	R/W-0	R/W-0	R/W-0	R/W-0

LEGEND: R/W = Read/Write; R = Read only; -n = value after reset

表 9-60. ALTERNATIVE FOLDBACK Register Field Descriptions

Bit	Field	Type	Reset	Description
7-4	ALTFBn	R	0	Alternative Foldback Enable bits: Used to enable the operational alternative foldback curves while powered. 1 = Alternative Foldback is enabled 0 = Alternative Foldback is disabled The ALTFBn bits should be set prior to issuing a PWONn command to ensure the desired foldback curve is being used.
3-0	ALTIRn	R	0	Alternative Inrush Enable bits: Used to enable the alternative foldback curves during inrush on channel n 1 = Alternative Inrush is enabled 0 = Alternative Inrush is disabled Note: The ALTIRn bits need to be set prior to sending a PWONn command to ensure the desired inrush behavior is followed



图 9-74. 1x Mode (2xFBn = 0) Foldback Curves, I_{PORT} vs V_{DRAIN}



图 9-75. 2x Mode (2xFBn = 1) Foldback Curves, I_{PORT} vs V_{DRAIN}

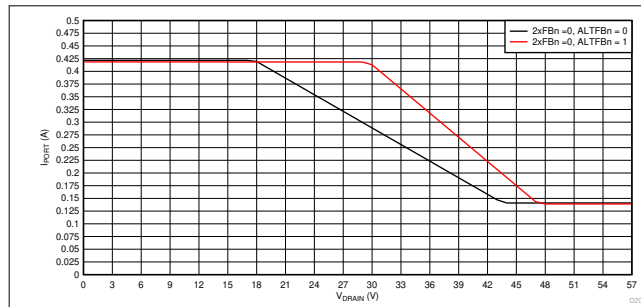

图 9-76. Inrush Foldback Curves, I_{PORT} vs V_{PORT}

9.6.2.67 SRAM CONTROL Register

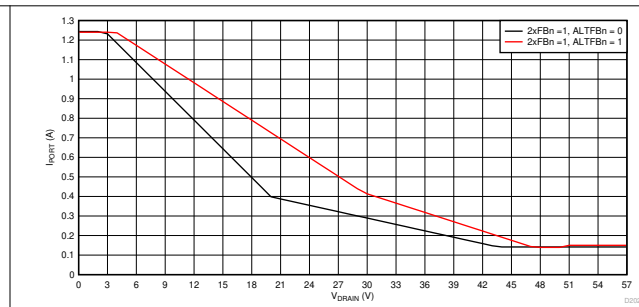
COMMAND = 60h with 1 Data Byte, Read/Write

图 9-77. SRAM CONTROL Register Format

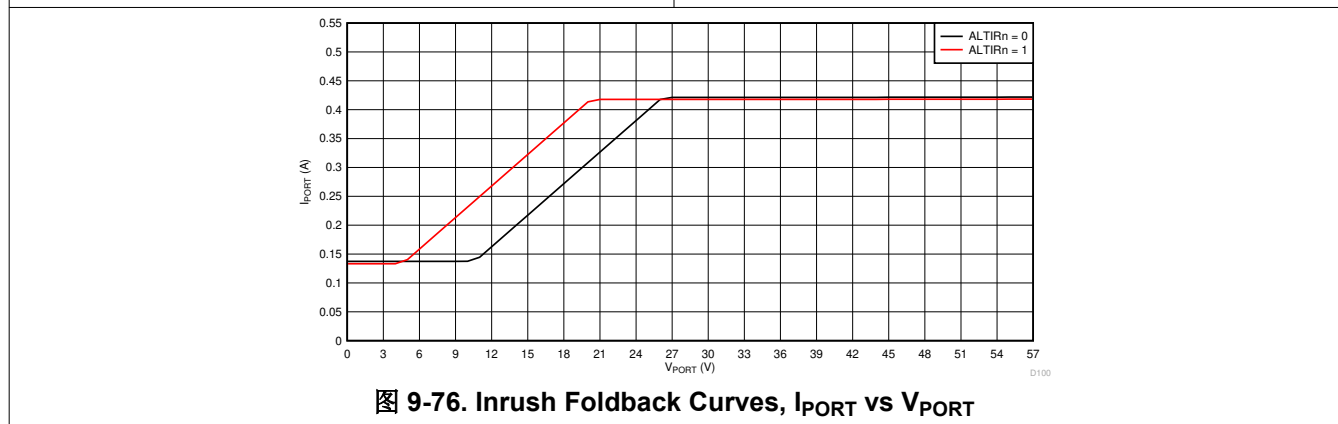
7	6	5	4	3	2	1	0
PROG_SEL	CPU_RST	-	PAR_EN	RAM_EN	PAR_SEL	R/WZ	CLR_PTR
R/W-0	R/W-0	R/W-0	R/W-0	R/W-0	R/W-0	R/W-0	R/W-0

LEGEND: R/W = Read/Write; R = Read only; -n = value after reset

表 9-61. SRAM CONTROL Register Field Descriptions

Bit	Field	Type	Reset	Description
7	PROG_SEL	R/W	0	I2C Programming select bit. 1 = SRAM I2C read/write is enabled 0 = SRAM I2C read/write is disabled.
6	CPU_RST	R/W	0	CPU Reset bit 1 = Internal CPU is held in RESET 0 = Internal CPU is active This is strictly a CPU reset. Toggling this bit reset the cpu only and will not change any contents of the I ² C registers
5	Reserved	R/W	0	Reserved
4	PAR_EN	R/W	0	SRAM Parity Enable bit: 1 = SRAM Parity Check will be enabled 0 = SRAM Parity Check will be disabled It is recommended that the Parity function be enable whenever SRAM is being used
3	RAM_EN	R/W	0	SRAM Enable bit 1 = SRAM will be enabled and the internal CPU will run from both SRAM and internal ROM 0 = Internal CPU will run from internal ROM only This bit needs to be set to a 1 after SRAM programing to enable the utilization of the SRAM code
2	PAR_SEL	R/W	0	SRAM Parity Select bit: Setting this bit to a 1 in conjunction with the RZ/W bit enables access to the SRAM Parity bits. 1 = Parity bits read/write is enabled 0 = Parity bits read/write is disabled
1	R/WZ	R/W	0	SRAM Read/Write select bit: 0 = SRAM Write - SRAM data is written with a write to 0x61h 1 = SRAM Read - SRAM data is read with a read from 0x61h SRAM data can be continuously read/written over I2C until a STOP bit is sent.
0	CLR_PTR	R/W	0	Clear Address Pointer bit: 1 = Resets the memory address pointer 0 = Releases pointer for use In order to ensure proper programming, this bit should be toggled (0-1-0) to writing or reading the SRAM or Parity memory.

9.6.2.67.1 SRAM START ADDRESS (LSB) Register

COMMAND = 62h with 1 Byte, Read/Write

图 9-78. SRAM START ADDRESS (LSB) Register Format

7	6	5	4	3	2	1	0
SA_7	SA_6	SA_5	SA_4	SA_3	SA_2	SA_1	SA_0
R/W-0	R/W-0	R/W-0	R/W-0	R/W-0	R/W-0	R/W-0	R/W-0

LEGEND: R/W = Read/Write; R = Read only; -n = value after reset

9.6.2.67.2 SRAM START ADDRESS (MSB) Register

COMMAND = 63h with 1 Byte, Read/Write

图 9-79. SRAM START ADDRESS (MSB) Register Format

7	6	5	4	3	2	1	0
SA_15	SA_14	SA_13	SA_12	SA_11	SA_10	SA_9	SA_8
R/W-0	R/W-0	R/W-0	R/W-0	R/W-0	R/W-0	R/W-0	R/W-0

LEGEND: R/W = Read/Write; R = Read only; -n = value after reset

9.6.2.67.3

表 9-62. SRAM START ADDRESS Register Field Descriptions

Bit	Field	Type	Reset	Description
15-0	SA_15- SA_0	R/W	0	SRAM and Parity Programming Start Address bits: the value entered into these registers sets the start address location for the SRAM or Parity programming

SRAM Programming:

Upon power up, it is recommended that the TPS23882B device's SRAM be programmed with the latest version of SRAM code via the I²C to ensure proper operation and IEEE complaint performance. All I²C traffic other than those commands required to program the SRAM should be deferred until after the SRAM programming sequences are completed.

备注

The latest version of firmware and SRAM release notes may be accessed from the [TI mySecure Software](#) webpage.

The SRAM Release Notes and ROM Advisory document includes more detailed information regarding any know issues and changes that were associated with each firmware release.

备注

The SRAM programming control must be completed at the lower I2C address (Channels 1-4, A0 = 0). Configuring this registers for the upper I2C device address (Channels 5-8) will not program the SRAM

For systems that include multiple TPS23882B devices, the 0x7F "global" broadcast I2C address may be used to programmed all of the devices at the same time.

备注

The SRAM programming needs to be delayed at least 50ms from the initial power on (VPWR and VDD above UVLO) of the device to allow for the device to complete its internal hardware initialization process

备注

For more detailed instructions on the SRAM programing procedures please refer the [How to Load TPS2388x SRAM Code](#) document on TI.com.

0x60h setup for SRAM Programming: Prior to programming/writing the SRAM, the following bits sequence needs to be completed in register 0x60h:

7	6	5	4	3	2	1	0
PROG_SEL	CPU_RST	-	PAR_EN	RAM_EN	PAR_SEL	R/WZ	CLR_PTR
0 → 1	0 → 1	0	0	0	0	1 → 0	0 → 1 → 0

The same sequence is required to read the SRAM with the exception that the R/WZ bit needs to be set to “1” .

If the device is in “Safe Mode” , the same sequence as above may be used to reprogram the SRAM.

An I²C write to 0x61h following this sequence actively programs the SRAM program memory starting from the address set in registers 0x62h and 63h.

0x60h setup for SRAM Parity Programming: Following the programming of the SRAM program memory, the following bits sequence needs to be completed in register 0x60h in order to configure the device to program the Parity memory:

7	6	5	4	3	2	1	0
PROG_SEL	CPU_RST	-	PAR_EN	RAM_EN	PAR_SEL	R/WZ	CLR_PTR
0 → 1	0 → 1	0	0	0	0 → 1	1 → 0	0 → 1 → 0

The same sequence is required to read the Parity with the exception that the R/WZ bit needs to be set to “1”.

An I²C write to 0x61h following this sequence actively programs the Parity memory starting from the address set in registers 0x62h and 63h.

0x60h setup to run from SRAM Program Memory: Upon completion of programming, the following bits sequence needs to be completed in register 0x60h in order to enable the device to run properly out of SRAM:

7	6	5	4	3	2	1	0
PROG_SEL	CPU_RST	-	PAR_EN	RAM_EN	PAR_SEL	R/WZ	CLR_PTR
1 → 0	1 → 0	0	0 → 1	0 → 1	1 → 0	0	0

Within 1ms of the completion of the above sequence, the device will complete a compatibility check on the SRAM

If the SRAM load is determined to be “Valid” : Register 0x41h will have a value between 0x01h and 0xFEh, and the device will return to normal operation.

If the SRAM load is determined to be “Invalid” :

- 0x41h will be set to 0xFFh
- The RAM_EN bit will be internally cleared
- The device will operating in “safe mode” until another programming attempt is completed

10 Application and Implementation

备注

以下应用部分中的信息不属于 TI 器件规格的范围，TI 不担保其准确性和完整性。TI 的客户应负责确定器件是否适用于其应用。客户应验证并测试其设计，以确保系统功能。

10.1 Application Information

The TPS23882B is an 8-channel, IEEE 802.3bt ready PoE PSE controller and can be used in high port count semiauto or fully micro-controller managed applications (TI recommends the MSP430FR5969 micro-controller for most applications). Subsequent sections describe detailed design procedures for applications with different requirements including host control.

The schematic of [图 10-1](#) depicts semiauto mode operation of the TPS23882B, providing functionality to power PoE loads. The TPS23882B can do the following:

1. Performs load detection
2. Performs classification including the 100-ms long finger for Autoclass discovery and 80.23bt reduce T_{MPS} support
3. Enables power on with protective foldback current limiting, and port power policing (P_{CUT}) value
4. Shuts down in the event of fault loads and shorts
5. Performs Maintain Power Signature function to insure removal of power if load is disconnected
6. Undervoltage lockout occurs if VPWR falls below V_{PUV_F} (typical 26.5 V)

Following a power-off command, disconnect or shutdown due to a Start, P_{CUT} or I_{LIM} fault, the port powers down. Following port power off due to a disconnect, the TPS23882B immediately restarts the detection and classification cycles if the DETE and CLE bits are set in register 0x14. If the shutdown is due to a start, P_{CUT} or I_{LIM} fault, the TPS23882B enters into a cool-down period during which any Detect/Class Enable Command for that port is delayed. At the end of cool down cycle, one or more detection/class cycles are automatically restarted if the class and/or detect enable bits are set. If a port is disabled using the power off command, the DETE and CLE bits are cleared and these bits must be reset over I²C for detection and classification to resume.

10.1.1 Autonomous Operation

Unlike Auto mode, which still requires a host to initialize the TPS23882B operation through a series of I²C commands, there is no host or I²C communication required when the TPS23882B is configured in autonomous mode.

Connecting a resistor between the AUTO pin and GND based on the table below [表 10-1](#) enables autonomous mode and configure all of the ports to the same Power Allocation settings. In the event a PD is connected with a higher requested class than the autonomous mode configuration, the port powers demote the PD to the selected autonomous mode configuration power level. The port automatically performs detection and classification (if valid detection occurs) continuously on all ports. Port power is automatically turned on based on Power Allocation settings in register 0x29 if a valid classification is measured.

表 10-1. AUTO Pin Programming

Auto Pin	Autonomous Mode Configuration
Open/Floating	Disabled
124 k Ω	2-pair 15 W
62 k Ω	2-pair 30 W

备注

A 10-nF capacitor is required in parallel with R_{AUTO} to ensure stability in the autonomous mode selection.

10.1.2 Introduction to PoE

Power-over-Ethernet (PoE) is a means of distributing power to Ethernet devices over the Ethernet cable using either data or spare pairs. PoE eliminates the need for power supplies at the Ethernet device. Common applications of PoE are security cameras, IP Phones and wireless access points (WAP). The host or mid-span equipment that supplies power is the power source equipment (PSE). The load at the Ethernet connector is the powered device (PD). PoE protocol between PSE and PD controlling power to the load is specified by IEEE 802.3bt standard. Transformers are used at Ethernet host ports, mid-spans and hubs, to interface data to the cable. A DC voltage can be applied to the center tap of the transformer with no effect on the data signals. As in any power transmission line, a relatively high voltage (approximately 50 V) is used to keep currents low and minimize the effects of IR drops in the line to preserve power delivery to the load. Standard 2-Pair PoE delivers approximately 13 W to a type 1 PD, and 25.5 W to a type 2 PD, whereas standard 4-Pair PoE are capable of delivering approximately 51 W to a type 3 PD and 71 W to a type 4 PD.

10.1.2.1 2-Pair Versus 4-Pair Power and the New IEEE802.3bt Standard

The IEEE 802.3at-2009 standard previously expanded PoE power delivery from 15.4 W (commonly referred to as .af or Type-1 PoE) to 30 W (.at or Type-2 PoE) of sourced power from the PSE (Power Sourcing Equipment) over 2-pairs of Ethernet wires (commonly known as either the Alt-A or Alt-B pair sets). The IEEE 802.3bt standard further expands power delivery up to 90 W sourced from a PSE by allowing for power delivery over both the ALT-A and ALT-B pairsets in parallel. Two new PoE equipment "Types" have also been created as part of the new standard. Type 3 PSE equipment is capable of sourcing up to 60 W of power over 4 pair or 30 W over 2 pair while supporting the new MPS requirements. Type 4 PSE equipment is capable of sourcing up to 90 W of power over 4 pair. The TPS23882B has been designed to be comply with the 2-Pair Type-3 requirements.

The Maintain Power Signature (or MPS) requirements have also been updated for the new standard. The previous version of the standard only required PSEs to maintain power on a port if the PD (Powered Device) current exceeded 10 mA for at least 60 ms every 300 ms to 400 ms. By decreasing these requirements to 6 ms every 320 ms to 400 ms, the minimum power requirement to maintain PoE power have been reduced by a factor of nearly 10.

10.2 Typical Application

This typical application shows an eight (2-Pair) port, semiauto mode application using a MSP430 or similar micro-controller. Operation in any mode requires I²C host support. The TPS23882B provides useful telemetry in multi-port applications to aid in implementing port power management.



图 10-1. Eight 2-Pair Port Application

10.2.1 Design Requirements

TPS23882B devices are used in the eight port configuration and are managed by the I²C host device. The I²C address for TPS23882B is programmed using the A4..A1 pins. When using multiple TPS23882B devices in a system, each device requires by a unique I²C address. See [PIN STATUS Register](#) for more information on how to program the TPS23882B I²C address.

A MCU is not required to operate the TPS23882B device, but some type of I²C controller and host controller device is required to program the internal SRAM and initialize the basic I²C register configuration of the TPS23882B.

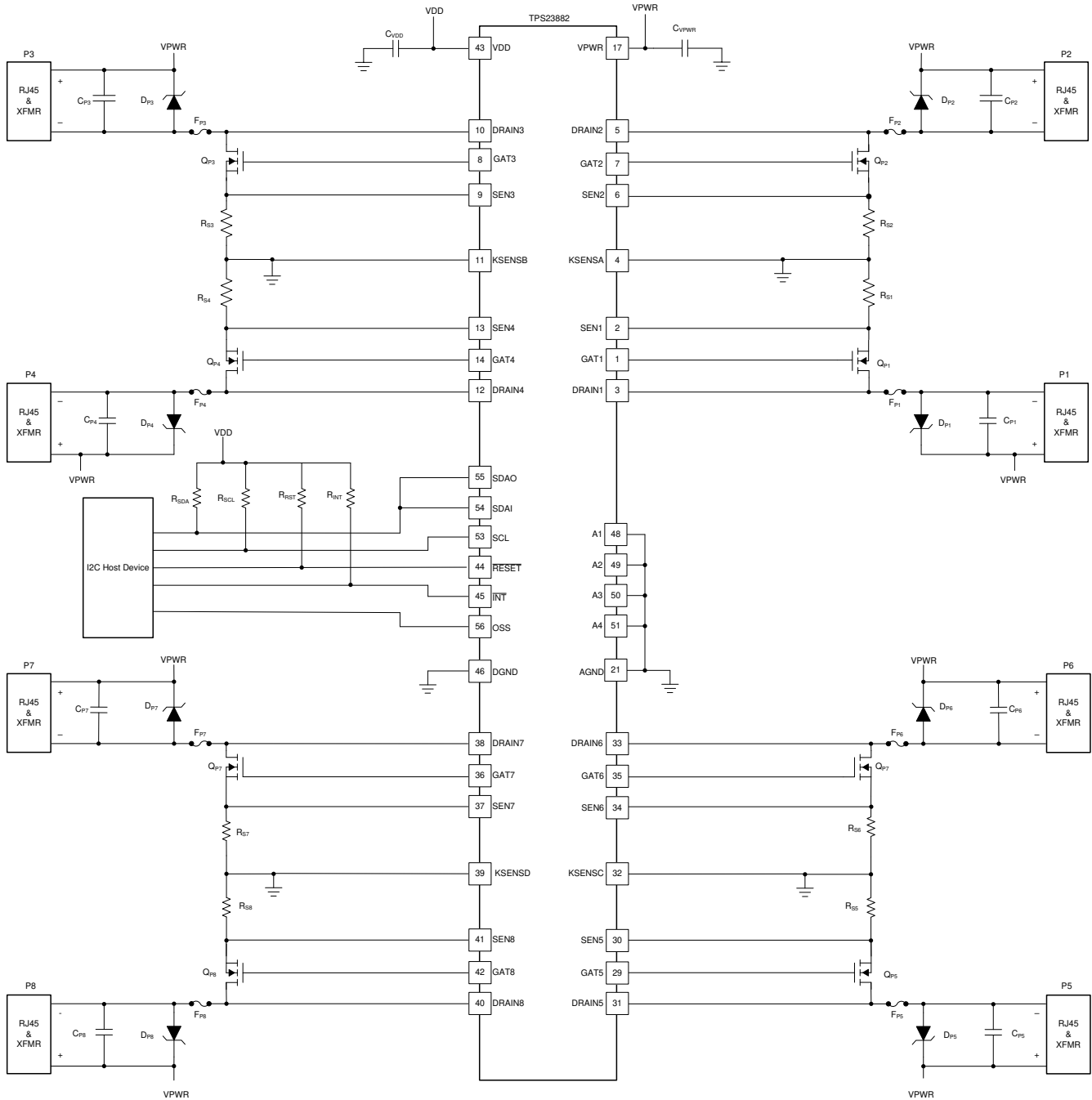
TI recommends that the $\overline{\text{RESET}}$ pin be connected to a micro-controller or other external circuitry.

备注

The $\overline{\text{RESET}}$ pin must be held low until both VPWR and VDD are above their UVLO thresholds.

Refer to the [TPS23882EVM: PoE, PSE, TPS23882 Evaluation Module user's guide](#) for more detailed information.

10.2.2 Detailed Design Procedure

Refer to the [TPS23882EVM: PoE, PSE, TPS23882 Evaluation Module user's guide](#) for more detailed information on component selection and layout recommendations.

10.2.2.1 Connections on Unused Channels

On unused channels, TI recommends to ground the SENx pin and leave the GATx pin open. DRAINx pins can be grounded or left open (leaving open can slightly reduce power consumption). [图 10-2](#) shows an example of an unused PORT2.



图 10-2. Unused PORT2 Connections

10.2.2.2 Power Pin Bypass Capacitors

- **C_{VPWR}**: 0.1- μ F, 100-V, X7R ceramic at pin 17 (VPWR)
- **C_{VDD}**: 0.1- μ F, 5-V, X7R ceramic at pin 43 (VDD)

10.2.2.3 Per Port Components

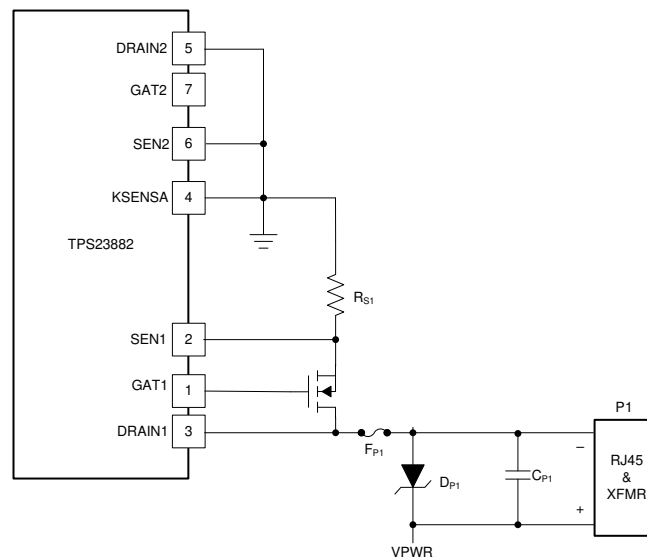
- **C_{Pn}**: 0.1- μ F, 100-V, X7R ceramic between VPWR and Pn-
- **R_{Sn}**: Each channel's current sense resistor is a 0.2- Ω . TI recommends a 1%, 0.25-W resistor in an 0805 SMT package. If a 30-W Policing (P_{CUT}) threshold is selected, the maximum power dissipation for the resistor becomes approximately 93.3 mW.

备注

For systems requiring either more accurate system power monitoring or precise Port Power Policing accuracy, TI recommends that 0.1% R_{SENSE} resistors be used.

- **Q_{Pn}**: The port MOSFET can be a small, inexpensive device with average performance characteristics. BV_{DSS} should be 100-V minimum. Target a MOSFET $R_{DS(on)}$ at $V_{GS} = 10$ V of between 50 m Ω and 150 m Ω . The MOSFET GATE charge (Q_G) and input capacitance (C_{ISS}) should be less than 50 nC and 2000 pF respectively. The maximum power dissipation for Q_{Pn} with $R_{DS(on)} = 100$ m Ω at 640 mA nominal policing (I_{CUT}) threshold is approximately 45 mW.

备注

In addition to the MOSFET $R_{DS(on)}$ and BV_{DSS} characteristics, the power MOSFET SOA ratings also must be taken into consideration when selecting these components for your system design. TI recommends that a MOSFET be chosen with an SOA rating that exceeds the inrush and operational foldback characteristic curves as shown in [图 9-2](#) and [图 9-3](#). When using the standard current foldback (ALTIRn or ALTFBn = 0) options, TI recommends the CSD19538Q3A 100V N-Channel MOSFET.

- **F_{Pn}**: The port fuse must be a slow blow type rated for at least 60 VDC and above approximately $2 \times P_{CUT}$ (maximum). The cold resistance must be below 200 m Ω to reduce the DC losses. The power dissipation for F_{Pn} with a cold resistance of 180 m Ω at maximum P_{CUT} is approximately 150 mW.
- **D_{PnA}**: The port TVS must be rated for the expected port surge environment. D_{PnA} must have a minimum reverse standoff voltage of 58 V and a maximum clamping voltage of less than 95 V at the expected peak surge current.

10.2.2.4 System Level Components (not Shown in the Schematic Diagrams)

The system TVS and bulk VPWR capacitance work together to protect the PSE system from surge events which can cause VPWR to surge above 70 V. The TVS and bulk capacitors must be placed on the PCB such that all TPS23882B ports are adequately protected.

- **TVS:** The system TVS must be rated for the expected peak surge power of the system and have a minimum reverse standoff voltage of 58 V. Together with the VPWR bulk capacitance, the TVS must prevent the VPWR rail from exceeding 70 V.
- **Bulk Capacitor:** The system bulk capacitors must be rated for 100 V and can be of aluminum electrolytic type. Two 47- μ F capacitors can be used for each TPS23882B on board.
- **Distributed Capacitance:** In higher port count systems, it can be necessary to distribute 1- μ F, 100-V, X7R ceramic capacitors across the 54-V power bus. TI recommends one capacitor per each TPS23882B pair.
- **Digital I/O Pullup Resistors:** RESET and A1-A4 are internally pulled up to VDD, while OSS is internally pulled down, each with a 50-k Ω (typical) resistor. A stronger pullup and down resistor can be added externally such as a 10 k Ω , 1%, 0.063 W type in a SMT package. SCL, SDAI, SDAO, and INT require external pullup resistors within a range of 1 k Ω to 10 k Ω depending on the total number of devices on the bus.
- **Ethernet Data Transformer (per port):** The Ethernet data transformer must be rated to operate within the IEEE802.3bt standard in the presence of the DC port current conditions. The transformer is also chosen to be compatible with the Ethernet PHY. The transformer may also be integrated into the RJ45 connector and cable terminations.
- **RJ45 Connector (per port):** The majority of the RJ45 connector requirements are mechanical in nature and include tab orientation, housing type (shielded or unshielded), or highly integrated. An integrated RJ45 consists of the Ethernet data transformer and cable terminations at a minimum. The integrated type may also contain the port TVS and common mode EMI filtering.
- **Cable Terminations (per port):** The cable terminations typically consist of series resistor (usually 75 Ω) and capacitor (usually 10 nF) circuits from each data transformer center tap to a common node which is then bypassed to a chassis ground (or system earth ground) with a high-voltage capacitor (usually 1000 pF to 4700 pF at 2 kV).

10.2.3 Application Curves

Unless otherwise noted, measurements taken on the TPS23882B EVM and Sifos PSA-3000 PowerSync Analyzer with PSA3202 test cards. Test conditions are $T_J = 25\text{ }^\circ\text{C}$, $V_{VDD} = 3.3\text{ V}$, $V_{VPWR} = 54\text{ V}$, $V_{DGND} = V_{AGND}$, DGND, KSENSA, KSENSB, KSENSC and KSENSD connected to AGND, and all outputs are unloaded, $2x\text{FBn} = 0$. Positive currents are into pins. $R_S = 0.200\ \Omega$, to KSENSA (SEN1 or SEN2), to KSENSB (SEN3 or SEN4), to KSENSC (SEN5 or SEN6) or to KSENSD (SEN7 or SEN8). All voltages are with respect to AGND unless otherwise noted. Operating registers loaded with default values unless otherwise noted.



图 10-3. I_{LIM} Foldback and Turn-Off



图 10-4. Backoff Due to PCut Fault

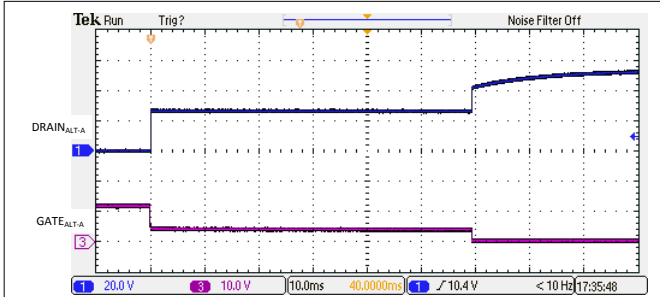

图 10-5. Open Circuit Detection Signature

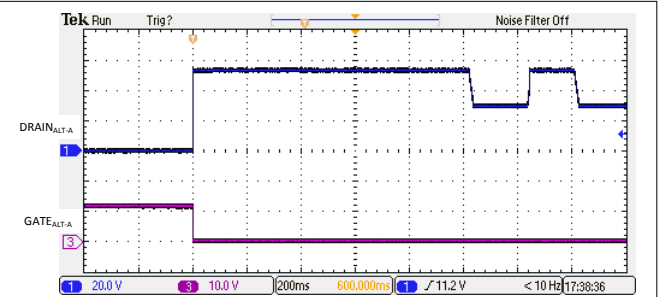

图 10-6. Semiauto Mode Discovery with a Valid Class 0-3 Load

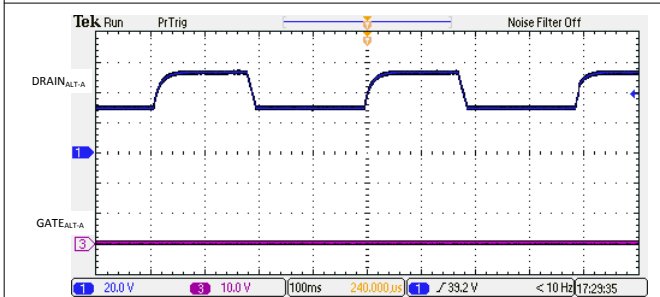

图 10-7. 1-Finger Classification and Turn-On

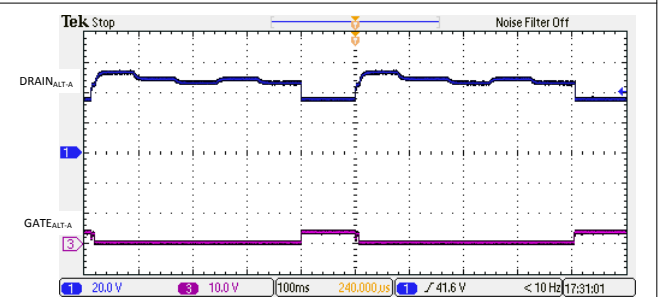

图 10-8. 3-Finger Classification and Turn-On

11 Power Supply Recommendations

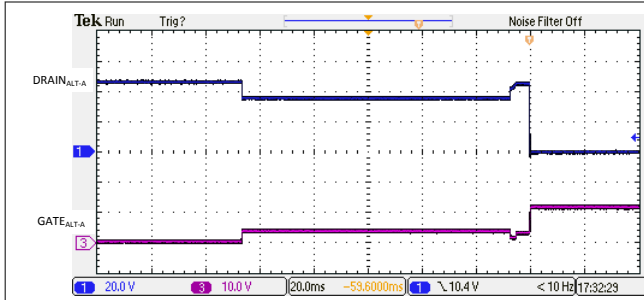
11.1 VDD

The recommended VDD supply voltage requirement is 3.3 V, ± 0.3 V. The TPS23882B requires approximately 6-mA typical and 12-mA maximum from the VDD supply. The VDD supply can be generated from VPWR with a buck-type regulator (TI recommends a LM5017 based device for a higher port count PSE using multiple TPS23882B devices operating in semiauto mode). The power supply design must ensure the VDD rail rises monotonically through the VDD UVLO thresholds without any droop under the UVLO_fall threshold as the loads are turned on. This action is accomplished with proper bulk capacitance across the VDD rail for the expected load current steps over worst case design corners. Furthermore, the combination of decoupling capacitance and bulk storage capacitance must hold the VDD rail above the UVLO_fall threshold during any expected transient outages after power is applied.

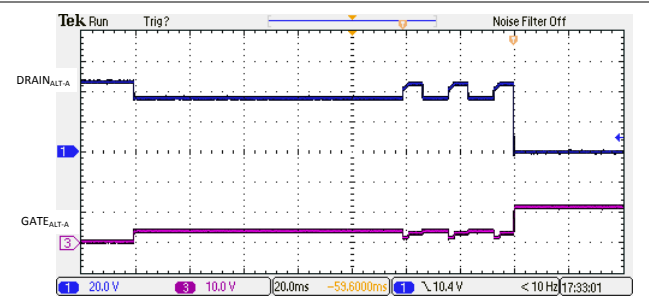
11.2 VPWR

Although the supported VPWR supply voltage range is 44 V to 57 V, as with the 802.3at standard for Type-2 PoE, a 50-V minimum supply is required to comply with 2-Pair Type-3 (up to 30W) IEEE requirements. The TPS23882B requires approximately 10-mA typical and 12-mA maximum from the VPWR supply, but the total output current required from the VPWR supply depends on the number and type of ports required in the system. The TPS23882B can be configured to support either 15.5 W, or 30 W per port and the power limit is set proportionally at turn-on. The port power limit, P_{CUT} , is also programmable to provide even greater system design flexibility. However, size the VPWR supply accordingly to the PoE Type to be supported. As an example, TI recommends a 130-W or greater power supply for eight type 1 (15.5 W each) ports, or TI recommends a 250-W or greater power supply for eight 2-pair type 3 (30 W) ports, assuming maximum port and standby currents.

备注

In IEEE compliant applications, only 4-pair configured ports are capable of supporting power levels greater than 30 W.

12 Layout

12.1 Layout Guidelines

12.1.1 Kelvin Current Sensing Resistors

Load current in each PSE channel is sensed as the voltage across a low-end current-sense resistor with a value of $200\text{ m}\Omega$. For more accurate current sensing, kelvin sensing of the low end of the current-sense resistor is provided through pins KSENSA for channels 1 and 2, KSENSB for channels 3 and 4, KSENSC for channels 5 and 6 and KSENSD for channels 7 and 8.



图 12-1. Kelvin Current-Sense Connection

KSENSA is shared between SEN1 and SEN2, KSENSB is shared between SEN3 and SEN4, KSENSC is shared between SEN5 and SEN6, and KSENSD is shared between SEN7 and SEN8. To optimize the accuracy of the measurement, the PCB layout must be done carefully to minimize impact of PCB trace resistance. Refer to 图 12-2 as an example.

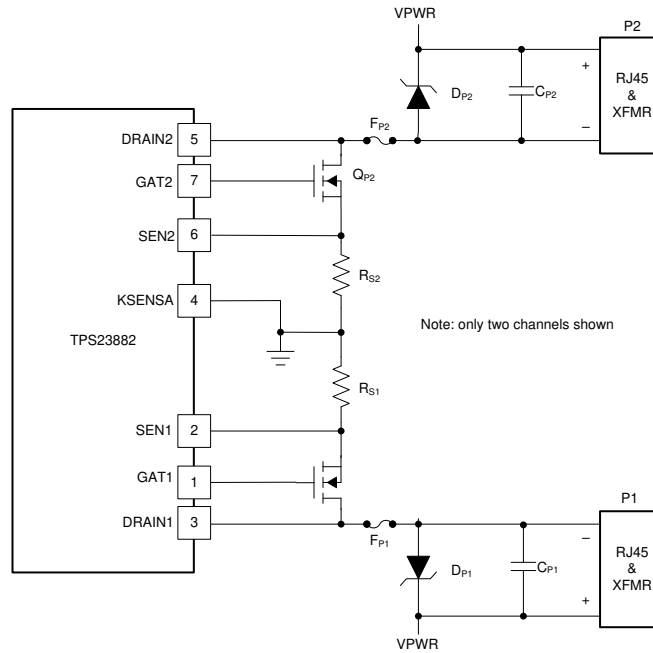

图 12-2. Kelvin Sense Layout Example

12.2 Layout Example

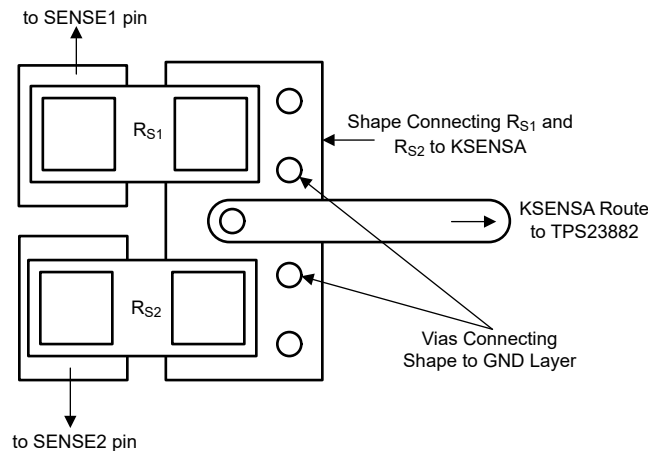
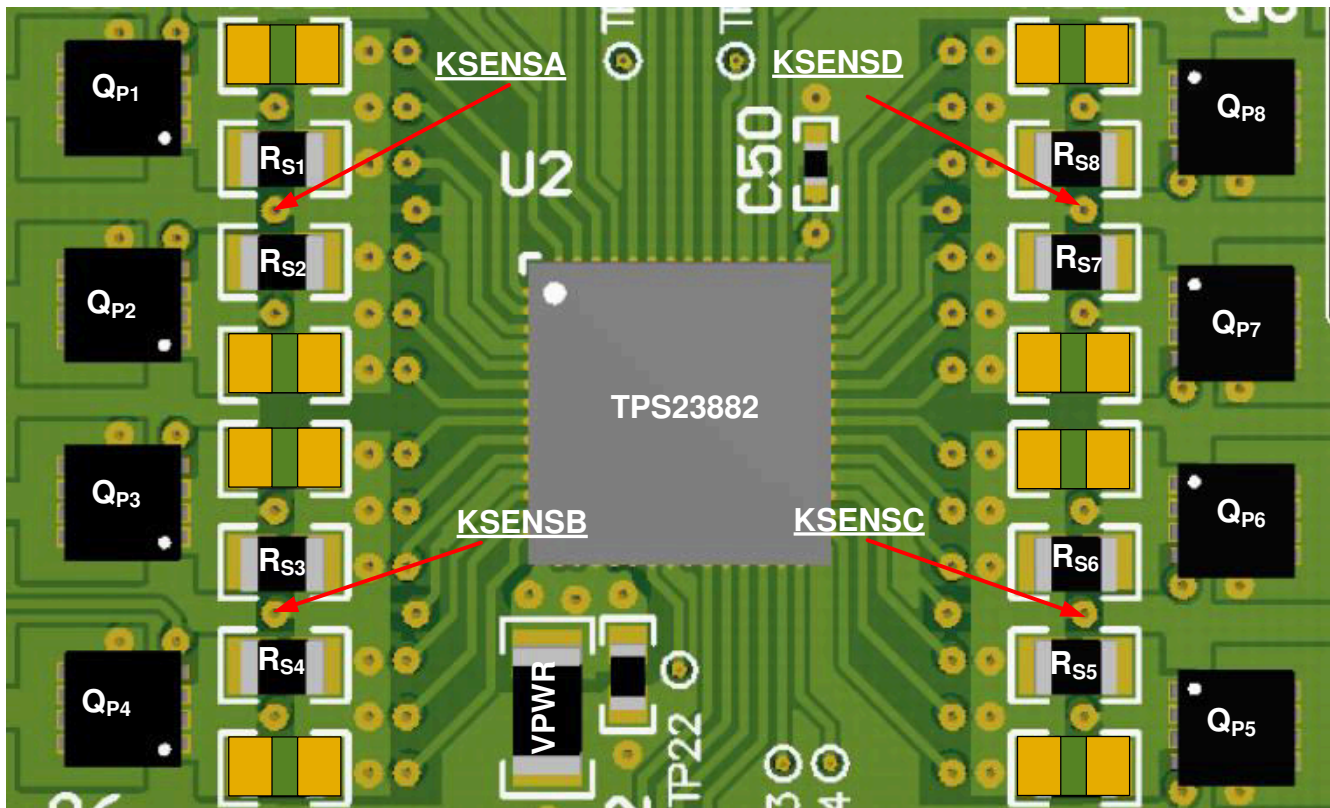

Note: PCB layout includes footprints for optional parallel R_{SENSE} resistors

图 12-3. Eight Port Layout Example (Top Side)

12.2.1 Component Placement and Routing Guidelines

12.2.1.1 Power Pin Bypass Capacitors

- C_{VPWR} : Place close to pin 17 (VPWR) and connect with low inductance traces and vias according to 图 12-3.
- C_{VDD} : Place close to pin 43 (VDD) and connect with low inductance traces and vias according to 图 12-3.

12.2.1.2 Per-Port Components

- R_{SnA} / R_{SnB} : Place according to in a manner that facilitates a clean Kelvin connection with KSENSEA/B/C/D.
- Q_{Pn} : Place Q_{Pn} around the TPS23882B as illustrated in 图 12-3. Provide sufficient copper from Q_{Pn} drain to F_{Pn} .
- F_{Pn} , C_{Pn} , D_{PnA} , D_{PnB} : Place this circuit group near the RJ45 port connector (or port power interface if a daughter board type of interface is used as illustrated in 图 12-3). Connect this circuit group to Q_{Pn} drain or GND (TPS23882B- AGND) using low inductance traces.

13 Device and Documentation Support

13.1 Documentation Support

13.1.1 Related Documentation

For related documentation see the following:

- Texas Instruments, [How to Load TPS2388x SRAM and Parity Code Over I²C application brief](#)
- Texas Instruments, [TPS23882BEVM user's guide](#)
- [IEEE 802.3bt Ready PSE Daughter Card for 24-port PSE System](#)
- Texas Instruments, [How to Load TPS2388x SRAM and Parity Code Over I² application report](#)
- [TI mySecure Software](#)

13.2 接收文档更新通知

要接收文档更新通知，请导航至 [ti.com](#) 上的器件产品文件夹。点击 [订阅更新](#) 进行注册，即可每周接收产品信息更改摘要。有关更改的详细信息，请查看任何已修订文档中包含的修订历史记录。

13.3 支持资源

[TI E2E™ 支持论坛](#) 是工程师的重要参考资料，可直接从专家获得快速、经过验证的解答和设计帮助。搜索现有解答或提出自己的问题可获得所需的快速设计帮助。

链接的内容由各个贡献者“按原样”提供。这些内容并不构成 TI 技术规范，并且不一定反映 TI 的观点；请参阅 TI 的 [《使用条款》](#)。

13.4 Trademarks

TI E2E™ is a trademark of Texas Instruments.

所有商标均为其各自所有者的财产。

13.5 Electrostatic Discharge Caution



This integrated circuit can be damaged by ESD. Texas Instruments recommends that all integrated circuits be handled with appropriate precautions. Failure to observe proper handling and installation procedures can cause damage.

ESD damage can range from subtle performance degradation to complete device failure. Precision integrated circuits may be more susceptible to damage because very small parametric changes could cause the device not to meet its published specifications.

13.6 术语表

[TI 术语表](#) 本术语表列出并解释了术语、首字母缩略词和定义。

14 Mechanical, Packaging, and Orderable Information

The following pages include mechanical, packaging, and orderable information. This information is the most current data available for the designated devices. This data is subject to change without notice and revision of this document. For browser-based versions of this data sheet, refer to the left-hand navigation.

PACKAGING INFORMATION

Orderable Device	Status (1)	Package Type	Package Drawing	Pins	Package Qty	Eco Plan (2)	Lead finish/ Ball material (6)	MSL Peak Temp (3)	Op Temp (°C)	Device Marking (4/5)	Samples
TPS23882B1RTQR	ACTIVE	QFN	RTQ	56	2000	RoHS & Green	NIPDAUAG	Level-3-260C-168 HR	-40 to 125	TPS23882B1	Samples

(1) The marketing status values are defined as follows:

ACTIVE: Product device recommended for new designs.

LIFEBUY: TI has announced that the device will be discontinued, and a lifetime-buy period is in effect.

NRND: Not recommended for new designs. Device is in production to support existing customers, but TI does not recommend using this part in a new design.

PREVIEW: Device has been announced but is not in production. Samples may or may not be available.

OBSOLETE: TI has discontinued the production of the device.

(2) **RoHS:** TI defines "RoHS" to mean semiconductor products that are compliant with the current EU RoHS requirements for all 10 RoHS substances, including the requirement that RoHS substance do not exceed 0.1% by weight in homogeneous materials. Where designed to be soldered at high temperatures, "RoHS" products are suitable for use in specified lead-free processes. TI may reference these types of products as "Pb-Free".

RoHS Exempt: TI defines "RoHS Exempt" to mean products that contain lead but are compliant with EU RoHS pursuant to a specific EU RoHS exemption.

Green: TI defines "Green" to mean the content of Chlorine (Cl) and Bromine (Br) based flame retardants meet JS709B low halogen requirements of <=1000ppm threshold. Antimony trioxide based flame retardants must also meet the <=1000ppm threshold requirement.

(3) MSL, Peak Temp. - The Moisture Sensitivity Level rating according to the JEDEC industry standard classifications, and peak solder temperature.

(4) There may be additional marking, which relates to the logo, the lot trace code information, or the environmental category on the device.

(5) Multiple Device Markings will be inside parentheses. Only one Device Marking contained in parentheses and separated by a "-" will appear on a device. If a line is indented then it is a continuation of the previous line and the two combined represent the entire Device Marking for that device.

(6) Lead finish/Ball material - Orderable Devices may have multiple material finish options. Finish options are separated by a vertical ruled line. Lead finish/Ball material values may wrap to two lines if the finish value exceeds the maximum column width.

Important Information and Disclaimer:The information provided on this page represents TI's knowledge and belief as of the date that it is provided. TI bases its knowledge and belief on information provided by third parties, and makes no representation or warranty as to the accuracy of such information. Efforts are underway to better integrate information from third parties. TI has taken and continues to take reasonable steps to provide representative and accurate information but may not have conducted destructive testing or chemical analysis on incoming materials and chemicals. TI and TI suppliers consider certain information to be proprietary, and thus CAS numbers and other limited information may not be available for release.

In no event shall TI's liability arising out of such information exceed the total purchase price of the TI part(s) at issue in this document sold by TI to Customer on an annual basis.

TAPE AND REEL INFORMATION

QUADRANT ASSIGNMENTS FOR PIN 1 ORIENTATION IN TAPE

*All dimensions are nominal

Device	Package Type	Package Drawing	Pins	SPQ	Reel Diameter (mm)	Reel Width W1 (mm)	A0 (mm)	B0 (mm)	K0 (mm)	P1 (mm)	W (mm)	Pin1 Quadrant
TPS23882B1RTQR	QFN	RTQ	56	2000	330.0	16.4	8.3	8.3	1.1	12.0	16.0	Q2

TAPE AND REEL BOX DIMENSIONS



*All dimensions are nominal

Device	Package Type	Package Drawing	Pins	SPQ	Length (mm)	Width (mm)	Height (mm)
TPS23882B1RTQR	QFN	RTQ	56	2000	367.0	367.0	38.0

GENERIC PACKAGE VIEW

RTQ 56

VQFN - 1 mm max height

8 x 8, 0.5 mm pitch

PLASTIC QUAD FLATPACK - NO LEAD

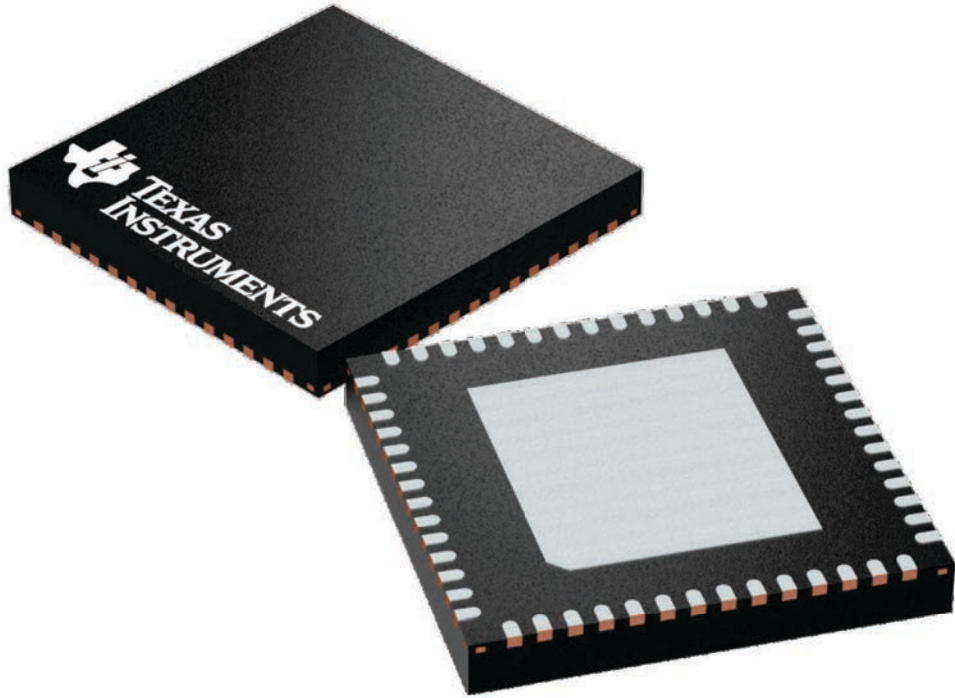

Images above are just a representation of the package family, actual package may vary.
Refer to the product data sheet for package details.

4224653/A

EXAMPLE BOARD LAYOUT

RTQ0056E

VQFN - 1 mm max height

PLASTIC QUAD FLATPACK - NO LEAD

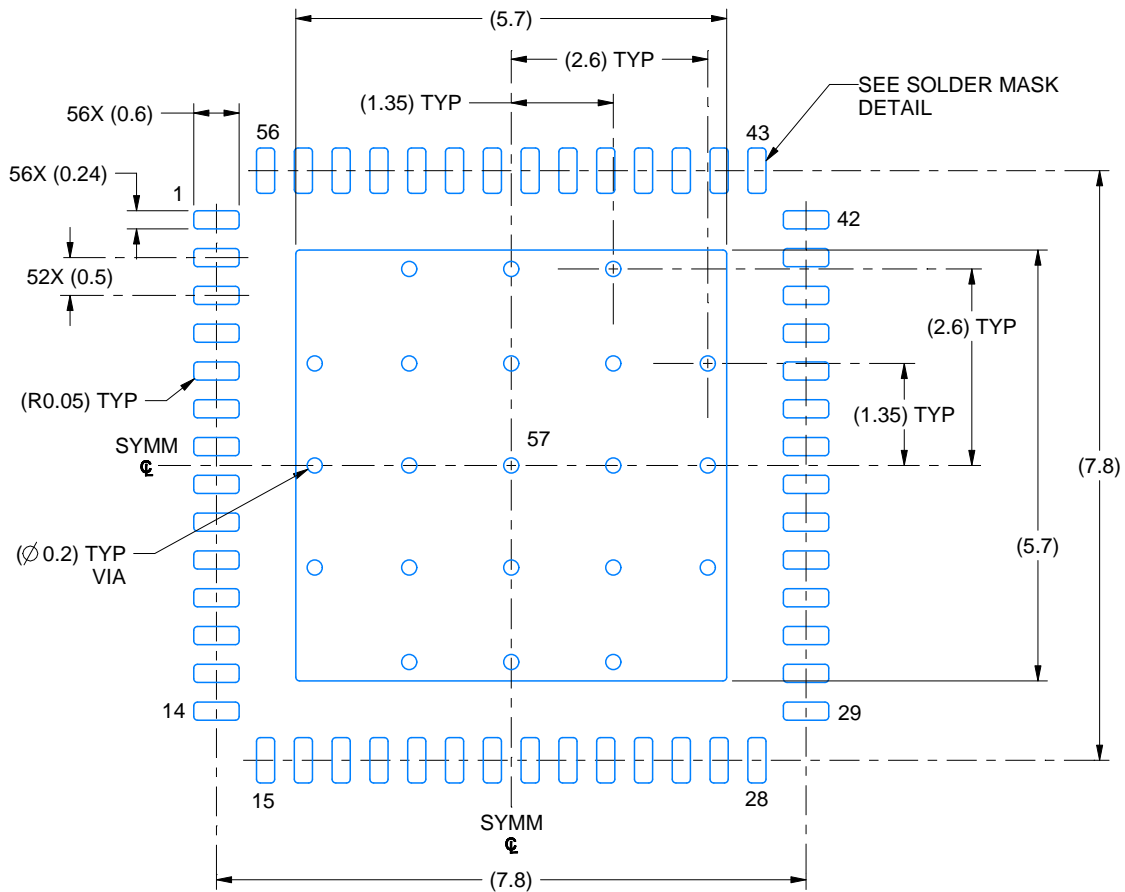

LAND PATTERN EXAMPLE
EXPOSED METAL SHOWN
SCALE: 10X

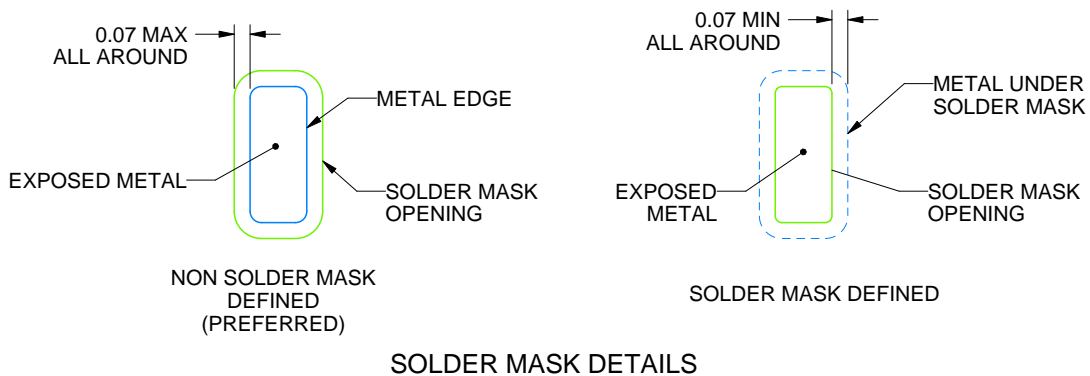

4224191/A 03/2018

NOTES: (continued)

- This package is designed to be soldered to a thermal pad on the board. For more information, see Texas Instruments literature number SLUA271 (www.ti.com/lit/sluea271).
- Vias are optional depending on application, refer to device data sheet. If any vias are implemented, refer to their locations shown on this view. It is recommended that vias under paste be filled, plugged or tented.

重要声明和免责声明

TI“按原样”提供技术和可靠性数据（包括数据表）、设计资源（包括参考设计）、应用或其他设计建议、网络工具、安全信息和其他资源，不保证没有瑕疵且不做任何明示或暗示的担保，包括但不限于对适销性、某特定用途方面的适用性或不侵犯任何第三方知识产权的暗示担保。

这些资源可供使用 TI 产品进行设计的熟练开发人员使用。您将自行承担以下全部责任：(1) 针对您的应用选择合适的 TI 产品，(2) 设计、验证并测试您的应用，(3) 确保您的应用满足相应标准以及任何其他功能安全、信息安全、监管或其他要求。

这些资源如有变更，恕不另行通知。TI 授权您仅可将这些资源用于研发本资源所述的 TI 产品的应用。严禁对这些资源进行其他复制或展示。您无权使用任何其他 TI 知识产权或任何第三方知识产权。您应全额赔偿因在这些资源的使用中对 TI 及其代表造成的任何索赔、损害、成本、损失和债务，TI 对此概不负责。

TI 提供的产品受 [TI 的销售条款](#) 或 [ti.com](#) 上其他适用条款/TI 产品随附的其他适用条款的约束。TI 提供这些资源并不会扩展或以其他方式更改 TI 针对 TI 产品发布的适用的担保或担保免责声明。

TI 反对并拒绝您可能提出的任何其他或不同的条款。

邮寄地址：Texas Instruments, Post Office Box 655303, Dallas, Texas 75265

Copyright © 2023，德州仪器 (TI) 公司

单击下面可查看定价，库存，交付和生命周期等信息

[>>TI\(德州仪器\)](#)