

TPS22916xx 1V 至 5.5V、2A 60mΩ 超低泄漏负载开关

1 特性

- 输入电压范围 (V_{IN}) : 1 V 至 5.5V
- 最大持续电流 (I_{MAX}) : 2A
- 导通电阻 (R_{ON}) :
 - 5V $V_{IN} = 60m\Omega$ (典型值)、 $100m\Omega$ ($85^{\circ}C$ 最大值)
 - 1.8V $V_{IN} = 100m\Omega$ (典型值)、 $150m\Omega$ ($85^{\circ}C$ 最大值)
 - 1V $V_{IN} = 200m\Omega$ (典型值)、 $325m\Omega$ ($85^{\circ}C$ 最大值)
- 超低功耗 :
 - 导通状态 (I_Q) : $0.5\mu A$ (典型值)、 $1\mu A$ (最大值)
 - 关闭状态 (I_{SD}) : $10nA$ (典型值)、 $100nA$ (最大值)
 - TPS22916BL/CL/CNL (I_{SD}) : $100nA$ (典型值)、 $300nA$ (最大值)
- ON 引脚智能下拉电阻 (R_{PD}) :
 - $ON \geq V_{IH}$ (I_{ON}) : $10nA$ (最大值)
 - $ON \leq V_{IL}$ (R_{PD}) : $750k\Omega$ (典型值)
- C 版本的慢时序可限制浪涌电流 :
 - 5V 开通时间 (t_{ON}) : $5mV/\mu s$ 时为 $1400\mu s$
 - 1.8V 开通时间 (t_{ON}) : $1mV/\mu s$ 时为 $3000\mu s$
 - 1V 开通时间 (t_{ON}) : $0.3mV/\mu s$ 时为 $6500\mu s$
- B 版本的快速时序可减少等待时间 :
 - 5V 开通时间 (t_{ON}) : $57mV/\mu s$ 时为 $115\mu s$
 - 1.8V 开通时间 (t_{ON}) : $12mV/\mu s$ 时为 $250\mu s$
 - 1V 开通时间 (t_{ON}) : $3.3mV/\mu s$ 时为 $510\mu s$
- 常开的真反向电流阻断 (RCB) :
 - 激活电流 (I_{RCB}) : $-500mA$ (典型值)
 - 反向泄漏电流 ($I_{IN,RCB}$) : $-300nA$ (最大值)
- 快速输出放电 (QOD) : 150Ω (典型值) (N 版本无 QOD)
- 低电平有效使能选项 (L 版本)

2 应用

- 可穿戴
- 智能电话
- 平板电脑
- 便携式扬声器

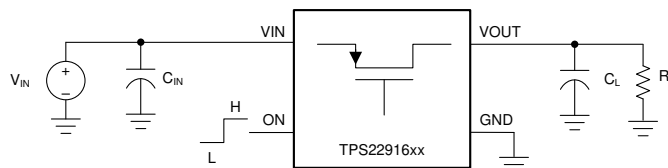

Copyright © 2017, Texas Instruments Incorporated

简化版原理图

3 说明

TPS22916xx 是一款小型单通道负载开关，采用低漏电 P 沟道 MOSFET 实现最小的功率损耗。高级栅极控制设计支持低至 1V 的工作电压，且增加超小的导通电阻和功率损耗。

多个时序选项可支持各种系统负载条件。对于高容性负载，C 版本的慢速导通时序可最大限度减小浪涌电流。而在低容性负载中，B 版本的快速时序可减少所需的等待时间。

开关导通状态由数字输入控制，此输入可与低压控制信号直接连接。此器件同时提供高电平有效和低电平有效 (L) 版本。首次加电时，此器件使用智能下拉电阻来保持 ON 引脚不悬空，直到系统时序控制完成。ON 引脚故意驱动为高电平 ($\geq V_{IH}$) 后，便会断开智能下拉电阻，从而防止不必要的功率损耗。

TPS22916xx 采用节省空间的小型 $0.78mm \times 0.78mm$ 、 $0.4mm$ 间距、 $0.5mm$ 高度的 4 引脚晶圆芯片级 (WCSP) 封装 (YFP)。此器件的工作温度范围为 $-40^{\circ}C$ 至 $+85^{\circ}C$ 。

器件信息(1)

器件型号	封装	封装尺寸 (标称值)
TPS22916xx	WCSP (4)	$0.78mm \times 0.78mm$

(1) 如需了解所有可用封装，请参阅产品说明书末尾的可订购产品附录。

器件比较表

版本	时序	QOD	使能 (ON)
TPS22916B	快	是	高电平有效
TPS22916BL	快	是	低电平有效
TPS22916C	慢	是	高电平有效
TPS22916CN	慢	否	高电平有效
TPS22916CL	慢	是	低电平有效
TPS22916CNL	慢	否	低电平有效



Table of Contents

1 特性	1	9 Application and Implementation	18
2 应用	1	9.1 Application Information.....	18
3 说明	1	9.2 Typical Application.....	18
4 Revision History	2	10 Power Supply Recommendations	19
5 Pin Configuration and Functions	3	11 Layout	20
6 Specifications	4	11.1 Layout Guidelines.....	20
6.1 Absolute Maximum Ratings.....	4	11.2 Layout Example.....	20
6.2 ESD Ratings.....	4	11.3 Thermal Considerations.....	20
6.3 Recommended Operating Conditions.....	4	12 Device and Documentation Support	21
6.4 Thermal Information.....	4	12.1 Documentation Support.....	21
6.5 Electrical Characteristics.....	5	12.2 接收文档更新通知.....	21
6.6 Switching Characteristics.....	6	12.3 支持资源.....	21
6.7 Typical Characteristics.....	8	12.4 Trademarks.....	21
7 Parameter Measurement Information	15	12.5 Electrostatic Discharge Caution.....	21
8 Detailed Description	16	12.6 术语表.....	21
8.1 Overview.....	16	13 Mechanical, Packaging, and Orderable Information	21
8.2 Functional Block Diagram.....	16	13.1 Tape and Reel Information.....	22
8.3 Feature Description.....	16		
8.4 Device Functional Modes.....	17		

4 Revision History

注：以前版本的页码可能与当前版本的页码不同

Changes from Revision E (September 2020) to Revision F (December 2021)	Page
• 向数据表添加了 TPS22916CNL 和 TPS22916BL 可订购产品.....	1
Changes from Revision D (October 2019) to Revision E (September 2020)	Page
• 更新了整个文档中的表格、图和交叉参考的编号格式.....	1
Changes from Revision C (October 2018) to Revision D (October 2019)	Page
• 将封装尺寸从 0.74mm x 0.74mm 更改为 0.78mm x 0.78mm.....	1
Changes from Revision B (December 2017) to Revision C (October 2018)	Page
• Changed Package Drawing Dimensions	21
Changes from Revision A (September 2017) to Revision B (December 2017)	Page
• 更改了标记为激光打标的引脚图.....	1
Changes from Revision * (July 2017) to Revision A (September 2017)	Page
• 将器件文档从“预告信息”更改为“量产数据”	1

5 Pin Configuration and Functions



图 5-1. YFP Package 4-Pin WSON Laser Marking View



图 5-2. YFP Package 4-Pin WSON Bump View

表 5-1. Pin Functions

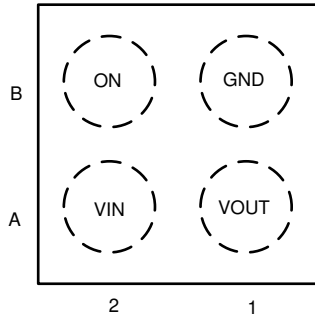
PIN		TYPE	DESCRIPTION
NO.	NAME		
A1	VOUT	Power	Switch output
A2	VIN	Power	Switch input
B1	GND	Ground	Device ground
B2	ON	Digital input	Device enable

6 Specifications

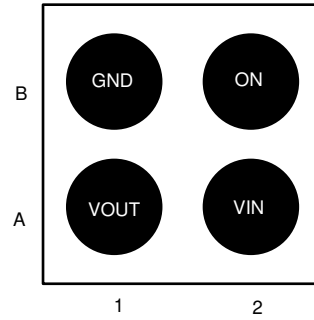
6.1 Absolute Maximum Ratings

Over operating free-air temperature range (unless otherwise noted)⁽¹⁾

		MIN	MAX	UNIT
V _{IN}	Input voltage	- 0.3	6	V
V _{OUT}	Output voltage	- 0.3	6	V
V _{ON}	Enable voltage	- 0.3	6	V
I _{MAX}	Maximum continuous switch current		2	A
I _{PLS}	Maximum pulsed switch current, pulse < 300-μs, 2% duty cycle		2.5	A
T _{J,MAX}	Maximum junction temperature		125	°C
T _{STG}	Storage temperature	- 65	150	°C
T _{LEAD}	Maximum Lead temperature (10-s soldering time)		300	°C

- (1) Stresses beyond those listed under *Absolute Maximum Ratings* may cause permanent damage to the device. These are stress ratings only, which do not imply functional operation of the device at these or any other conditions beyond those indicated under *Recommended Operating Conditions*. Exposure to absolute-maximum-rated conditions for extended periods may affect device reliability.

6.2 ESD Ratings

		VALUE	UNIT
V _(ESD)	Electrostatic discharge	±2000	V
		±500	

- (1) JEDEC document JEP155 states that 500-V HBM allows safe manufacturing with a standard ESD control process. Manufacturing with less than 500-V HBM is possible with the necessary precautions. Pins listed as ±2000 V may actually have higher performance.
- (2) JEDEC document JEP157 states that 250-V CDM allows safe manufacturing with a standard ESD control process. Manufacturing with less than 250-V CDM is possible with the necessary precautions. Pins listed as ±500 V may actually have higher performance.

6.3 Recommended Operating Conditions

Over operating free-air temperature range (unless otherwise noted)

		MIN	MAX	UNIT
V _{IN}	Input voltage	1	5.5	V
V _{OUT}	Output voltage	0	5.5	V
V _{IH}	High-level input voltage, ON	1	5.5	V
V _{IL}	Low-level input voltage, ON	0	0.35	V
T _A	Operating free-air temperature	- 40	85	°C

6.4 Thermal Information

Thermal Parameters ⁽¹⁾		TPS22916xx	UNIT
		YFP (WCSP)	
		4 PINS	
θ _{JA}	Junction-to-ambient thermal resistance	193	°C/W
θ _{JCtop}	Junction-to-case (top) thermal resistance	2.3	°C/W
θ _{JB}	Junction-to-board thermal resistance	36	°C/W
ψ _{JT}	Junction-to-top characterization parameter	12	°C/W
ψ _{JB}	Junction-to-board characterization parameter	36	°C/W

- (1) For more information about traditional and new thermal metrics, see the [Semiconductor and IC Package Thermal Metrics](#) application report.

6.5 Electrical Characteristics

Unless otherwise noted, the specification in the following table applies for all variants over the entire recommended power supply voltage range of 1 V to 5.5 V unless noted otherwise. Typical Values are at 25°C.

PARAMETER		TEST CONDITIONS	T _J	MIN	TYP	MAX	UNIT
INPUT SUPPLY (VIN)							
I _{Q,VIN}	V _{IN} Quiescent current	Enabled, V _{OUT} = Open	- 40°C to +85°C	0.5	1.0		μA
I _{SD,VIN}	V _{IN} Shutdown current	Disabled, V _{OUT} = GND (TPS22916B/C/CN)	- 40°C to +85°C	10	100		nA
		Disabled, V _{OUT} = GND (TPS22916BL/CL/CNL)	- 40°C to +85°C	100	300		nA
ON-RESISTANCE (R_{ON})							
R _{ON}	ON-Resistance	I _{OUT} = 200 mA	V _{IN} = 5 V	25°C	60	80	mΩ
				- 40°C to +85°C		100	
				- 40°C to +105°C		120	
			V _{IN} = 3.6 V	25°C	70	90	
				- 40°C to +85°C		120	
				- 40°C to +105°C		140	
			V _{IN} = 1.8 V	25°C	100	125	
				- 40°C to +85°C		150	
				- 40°C to +105°C		175	
			V _{IN} = 1.2 V	25°C	150	200	
				- 40°C to +85°C		250	
				- 40°C to +105°C		300	
V _{IN} = 1 V	25°C	200	275				
	- 40°C to +85°C		325				
	- 40°C to +105°C		375				
ENABLE PIN (ON)							
I _{ON}	ON Pin leakage	Enabled	- 40°C to +85°C	- 10		10	nA
R _{PD}	Smart Pull Down Resistance	Disabled	- 40°C to +85°C	750			kΩ
REVERSE CURRENT BLOCKING (RCB)							
I _{RCB}	RCB Activation Current	Enabled, V _{OUT} > V _{IN}	- 40°C to +85°C	-500			mA
t _{RCB}	RCB Activation time	Enabled, V _{OUT} > V _{IN} + 200mV	- 40°C to +85°C	10			μs
V _{RCB}	RCB Release Voltage	Enabled, V _{OUT} > V _{IN}	- 40°C to +85°C	25			mV
I _{IN,RCB}	VIN Reverse Leakage Current	0 V ≤ V _{IN} + V _{RCB} ≤ V _{OUT} ≤ 5.5 V	- 40°C to +85°C	-	300		nA
QUICK OUTPUT DISCHARGE (QOD)							
QOD ⁽¹⁾	Output discharge resistance	Disabled (Not in TPS22916CN/CNL)	- 40°C to +85°C	150			Ω

(1) For more information on which devices include quick output discharge, see the [Device Functional Modes](#) section.

6.6 Switching Characteristics

Unless otherwise noted, the typical characteristics in the following table applies over the entire recommended power supply voltage range of 1 V to 5.5 V at 25°C with a load of $C_L = 0.1\mu\text{F}$, $R_L = 10\Omega$.

PARAMETER		TEST CONDITIONS	MIN	TYP	MAX	UNIT
TPS22916B, TPS22916BL						
t_{ON}	Turn On Time	$V_{\text{IN}} = 5\text{ V}$		115		μs
		$V_{\text{IN}} = 3.6\text{ V}$		140		
		$V_{\text{IN}} = 1.8\text{ V}$		250		
		$V_{\text{IN}} = 1.2\text{ V}$		350		
		$V_{\text{IN}} = 1\text{ V}$		510		
t_{RISE}	Rise Time	$V_{\text{IN}} = 5\text{ V}$		70		μs
		$V_{\text{IN}} = 3.6\text{ V}$		80		
		$V_{\text{IN}} = 1.8\text{ V}$		130		
		$V_{\text{IN}} = 1.2\text{ V}$		190		
		$V_{\text{IN}} = 1\text{ V}$		240		
SR_{ON}	Slew Rate	$V_{\text{IN}} = 5\text{ V}$		57		$\text{mV}/\mu\text{s}$
		$V_{\text{IN}} = 3.6\text{ V}$		36		
		$V_{\text{IN}} = 1.8\text{ V}$		12		
		$V_{\text{IN}} = 1.2\text{ V}$		5.1		
		$V_{\text{IN}} = 1\text{ V}$		3.3		
t_{OFF}	Turn Off Time	$V_{\text{IN}} = 5\text{ V}$		5		μs
		$V_{\text{IN}} = 3.6\text{ V}$		5		
		$V_{\text{IN}} = 1.8\text{ V}$		10		
		$V_{\text{IN}} = 1.2\text{ V}$		15		
		$V_{\text{IN}} = 1\text{ V}$		25		
t_{FALL}	Fall Time	$C_L = 0.1\mu\text{F}$, $R_L = 10\Omega$ ⁽¹⁾		2.3		μs
		$C_L = 1\mu\text{F}$, $R_L = \text{Open}$ ⁽¹⁾		315		

6.6 Switching Characteristics (continued)

Unless otherwise noted, the typical characteristics in the following table applies over the entire recommended power supply voltage range of 1 V to 5.5 V at 25°C with a load of $C_L = 0.1\mu\text{F}$, $R_L = 10\Omega$.

PARAMETER	TEST CONDITIONS	MIN	TYP	MAX	UNIT
TPS22916C, TPS22916CN, TPS22916CL, TPS22916CNL					
t_{ON}	Turn On Time	$V_{IN} = 5\text{ V}$		1400	μs
		$V_{IN} = 3.6\text{ V}$		1700	
		$V_{IN} = 1.8\text{ V}$		3000	
		$V_{IN} = 1.2\text{ V}$		5000	
		$V_{IN} = 1\text{ V}$		6500	
t_{RISE}	Rise Time	$V_{IN} = 5\text{ V}$		800	μs
		$V_{IN} = 3.6\text{ V}$		900	
		$V_{IN} = 1.8\text{ V}$		1400	
		$V_{IN} = 1.2\text{ V}$		2300	
		$V_{IN} = 1\text{ V}$		3000	
SR_{ON}	Slew Rate	$V_{IN} = 5\text{ V}$		5	$\text{mV}/\mu\text{s}$
		$V_{IN} = 3.6\text{ V}$		3.2	
		$V_{IN} = 1.8\text{ V}$		1	
		$V_{IN} = 1.2\text{ V}$		0.4	
		$V_{IN} = 1\text{ V}$		0.3	
t_{OFF}	Turn Off Time	$V_{IN} = 5\text{ V}$		5	μs
		$V_{IN} = 3.6\text{ V}$		5	
		$V_{IN} = 1.8\text{ V}$		10	
		$V_{IN} = 1.2\text{ V}$		15	
		$V_{IN} = 1\text{ V}$		25	
t_{FALL}	Fall Time ⁽²⁾	$C_L = 0.1\mu\text{F}$, $R_L = 10\Omega$ ⁽¹⁾		2.3	μs
		$CL = 10\mu\text{F}$, $RL = \text{Open}$ ⁽¹⁾		3150	

- (1) See the [Fall Time \(\$t_{FALL}\$ \) and Quick Output Discharge \(QOD\)](#) section for information on how R_L and C_L affect Fall Time.
(2) Devices without Quick Output Discharge (QOD) may not discharge completely.

6.7 Typical Characteristics

6.7.1 Typical Electrical Characteristics

The typical characteristics curves in this section apply to all devices unless otherwise noted.



图 6-1. ON-Resistance vs Temperature



图 6-2. ON-Resistance vs Input voltage

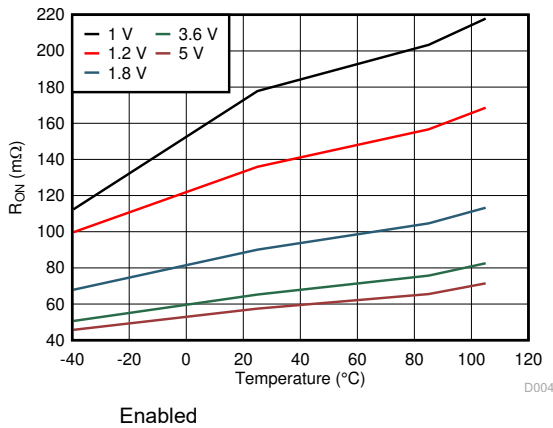

图 6-3. Shutdown Current

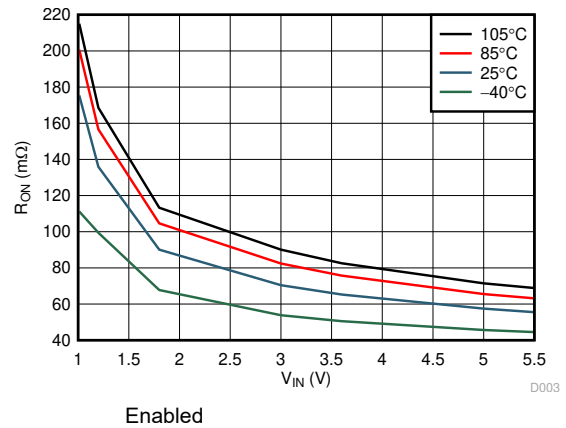

图 6-4. Shutdown Current (Active Low)

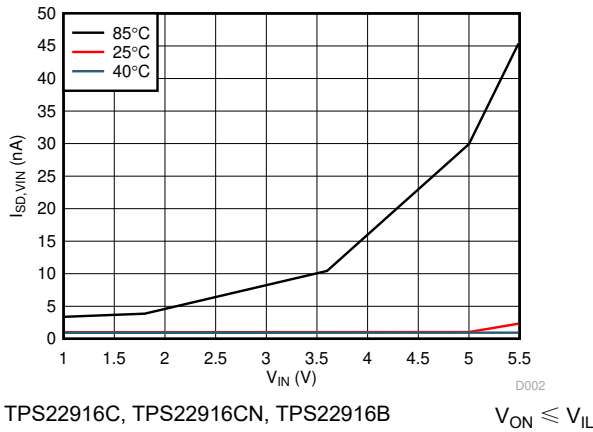

图 6-5. Quiescent Current

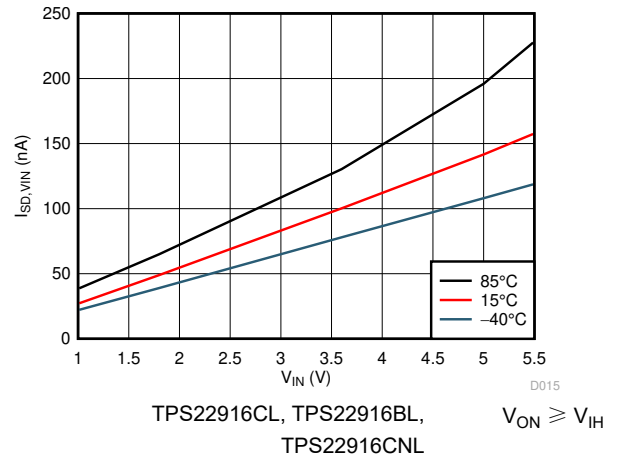

图 6-6. ON Pin Threshold

6.7.1 Typical Electrical Characteristics (continued)

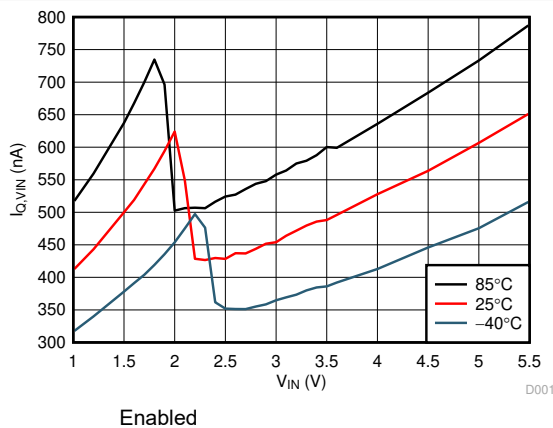
The typical characteristics curves in this section apply to all devices unless otherwise noted.

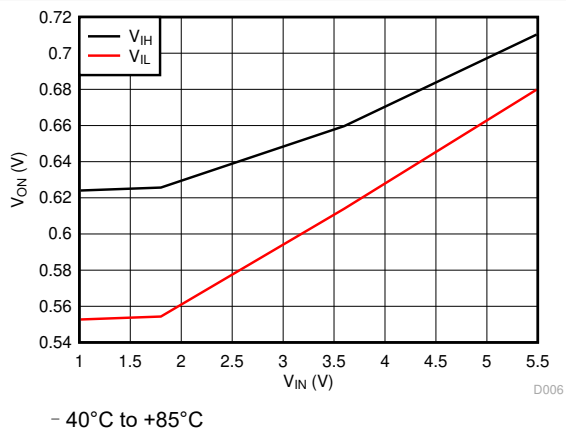
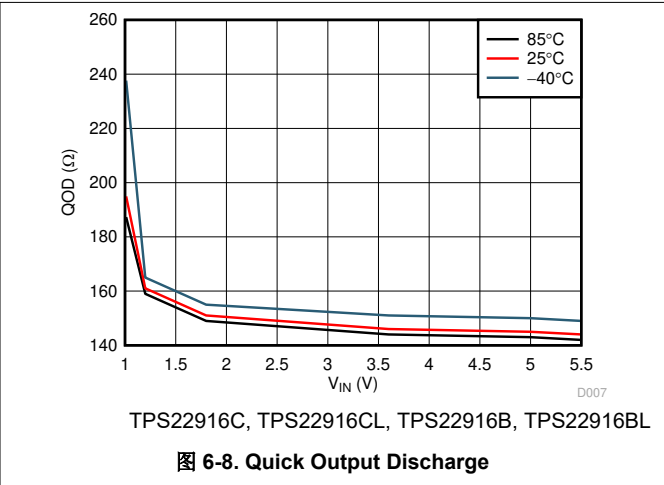
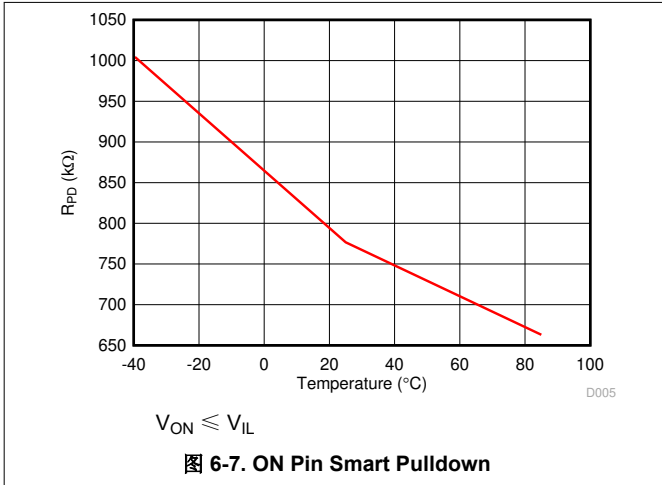

6.7.2 Typical Switching Characteristics



图 6-9. Fast Turn-On Time



图 6-10. Fast Turn-On at 5 V

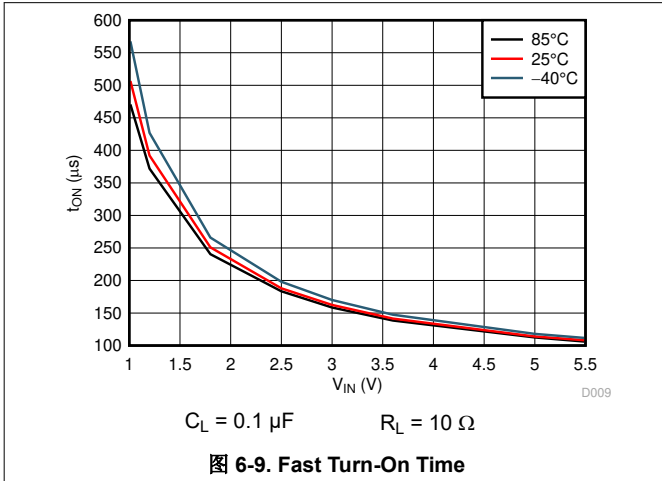

图 6-11. Fast Rise Time

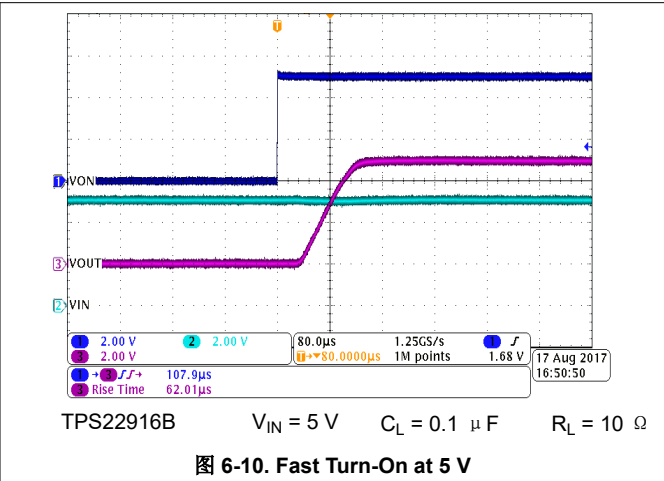

图 6-12. Fast Turn-On at 3.6 V

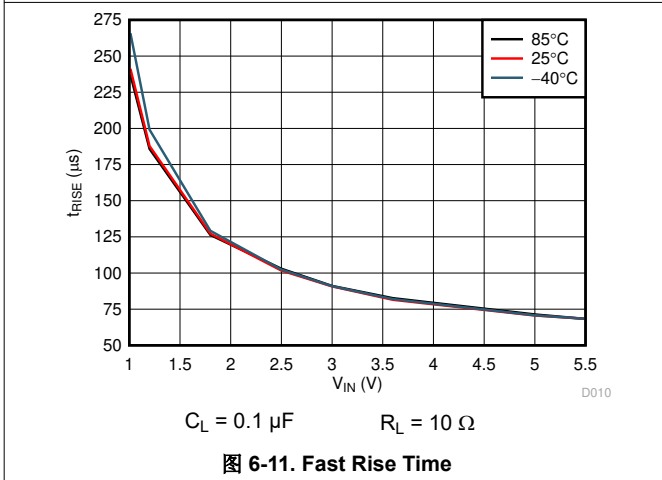

图 6-13. Fast Slew Rate

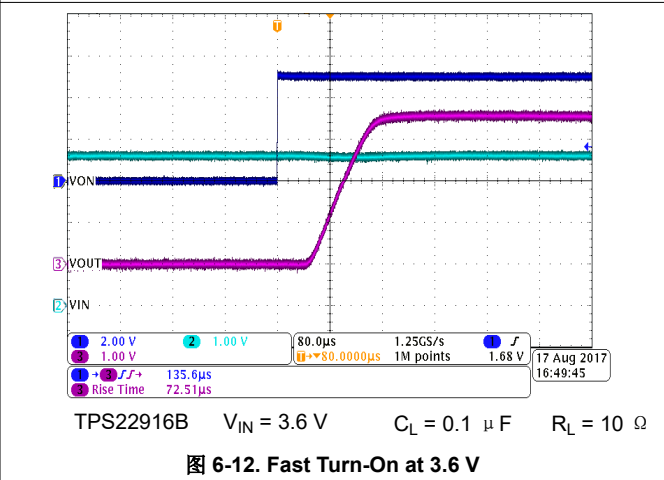

图 6-14. Fast Turn-On at 1 V

6.7.2 Typical Switching Characteristics (continued)

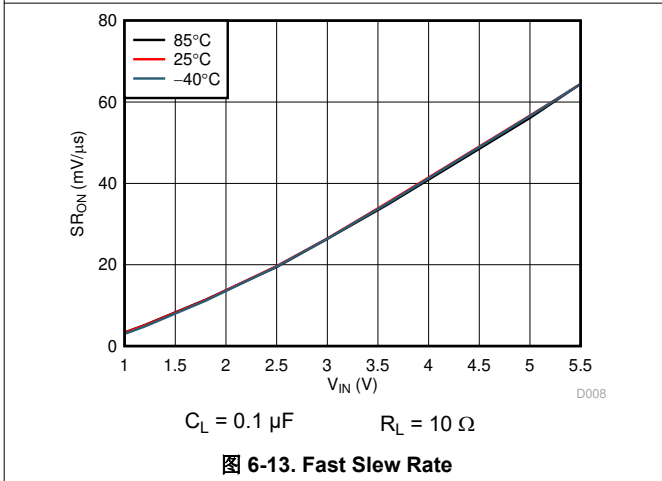

6.7.2 Typical Switching Characteristics (continued)

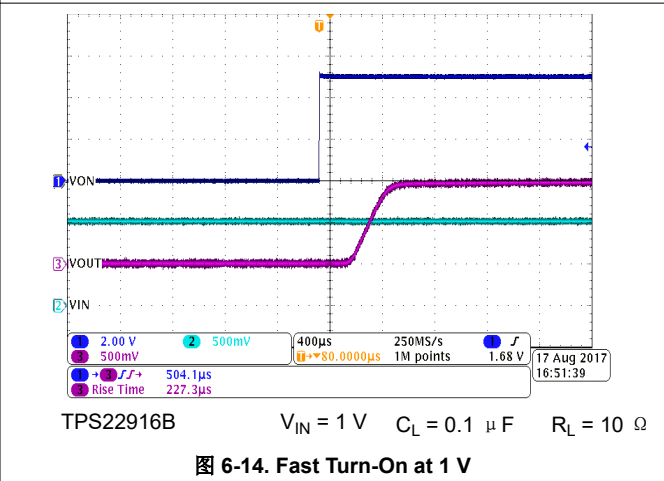
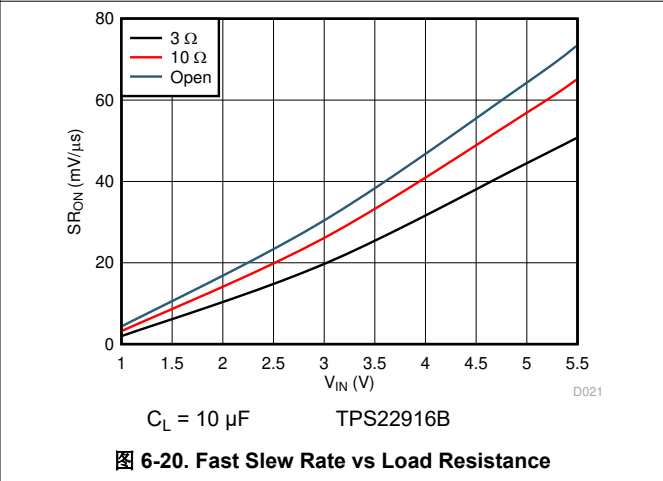
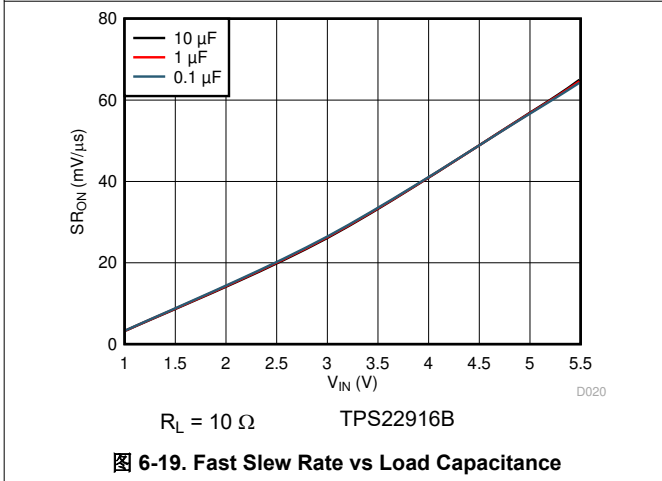
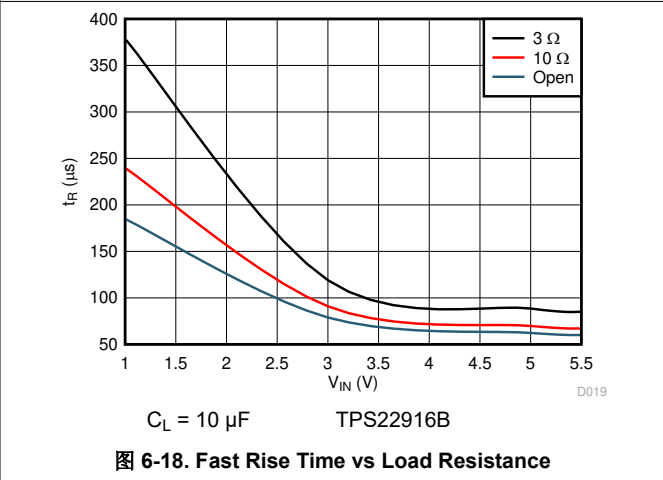
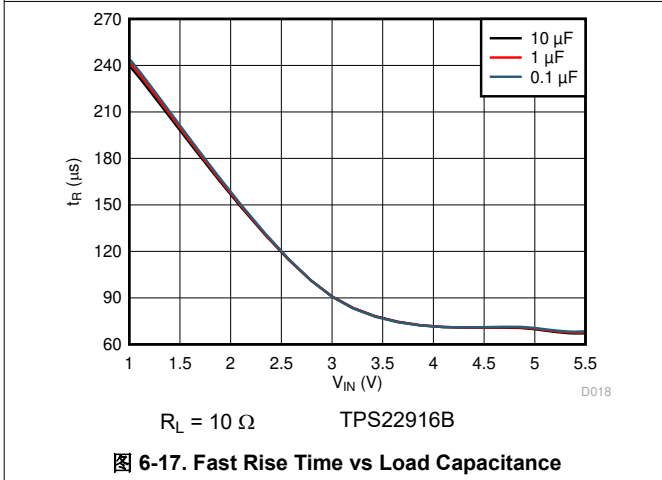
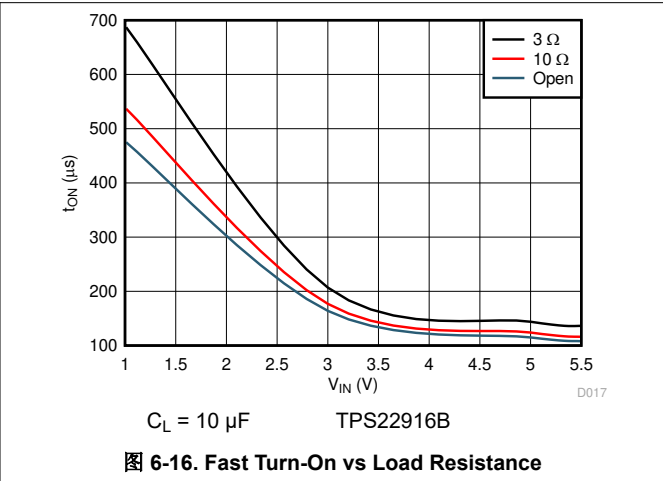
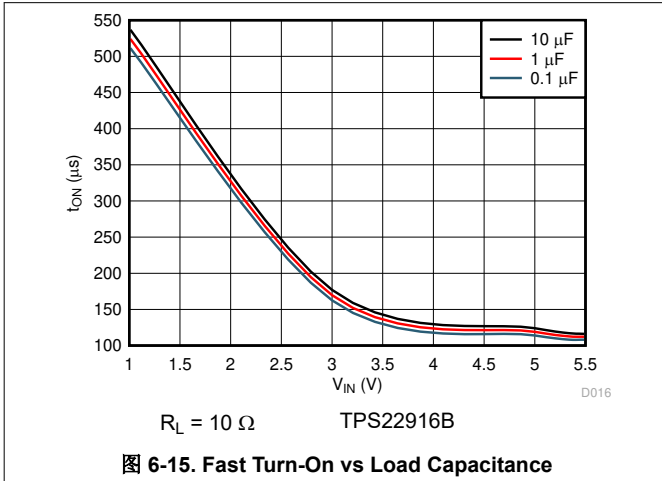

图 6-21. Slow Turn-On Time



图 6-22. Slow Turn-On at 5 V

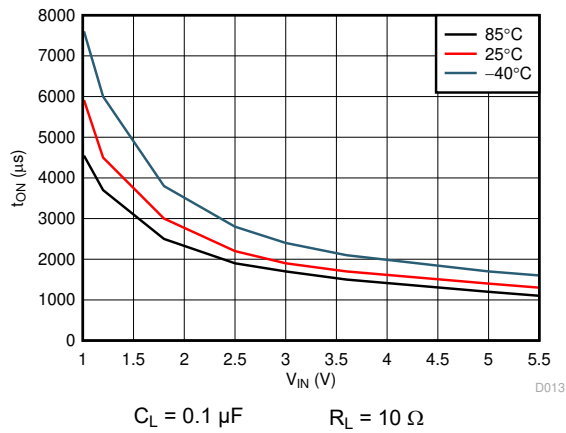

图 6-23. Slow Rise Time

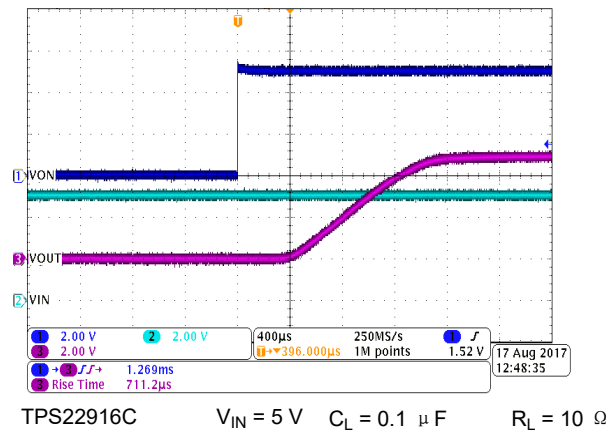

图 6-24. Slow Turn-On at 3.6 V

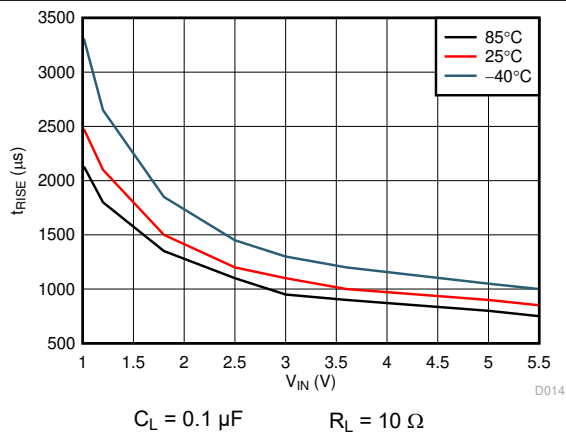

图 6-25. Slow Slew Rate

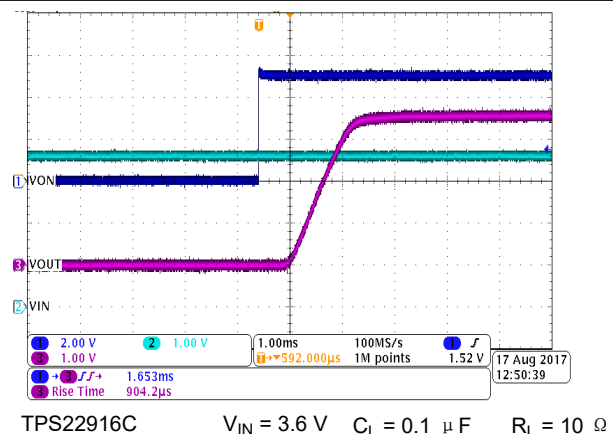

图 6-26. Slow Turn-On at 1 V

6.7.2 Typical Switching Characteristics (continued)

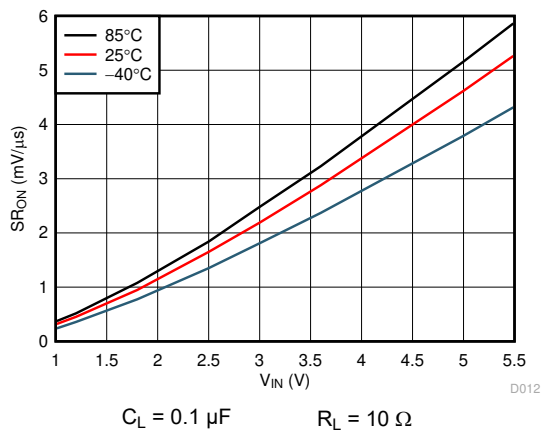

$R_L = 10 \Omega$ TPS22916C TPS22916CN TPS22916CL

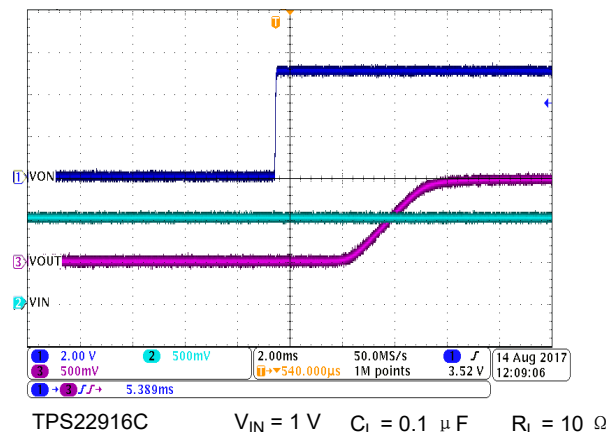
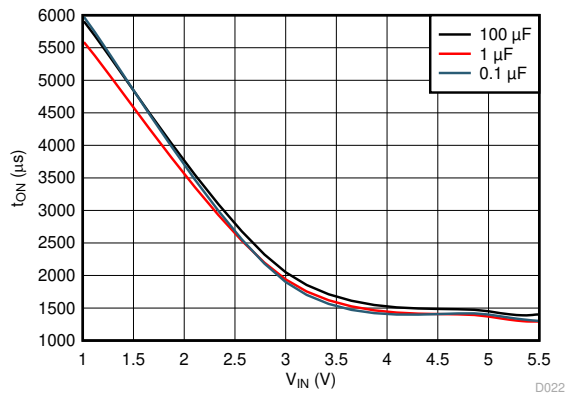
图 6-27. Slow Turn-On vs Load Capacitance

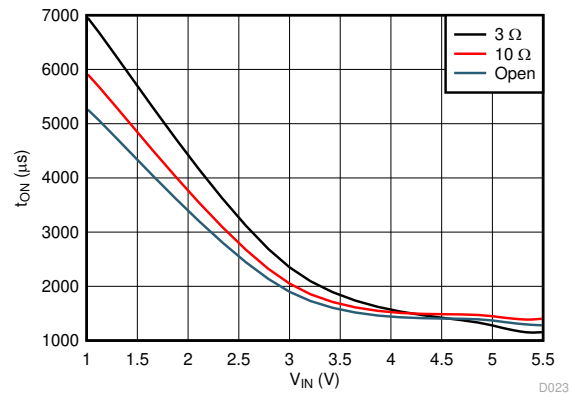

$C_L = 100 \mu\text{F}$ TPS22916C TPS22916CN TPS22916CL

图 6-28. Slow Turn-On vs Load Resistance

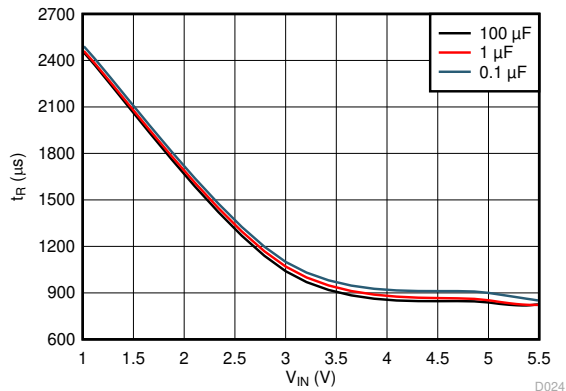

$R_L = 10 \Omega$ TPS22916C TPS22916CN TPS22916CL

图 6-29. Slow Rise Time vs Load Capacitance

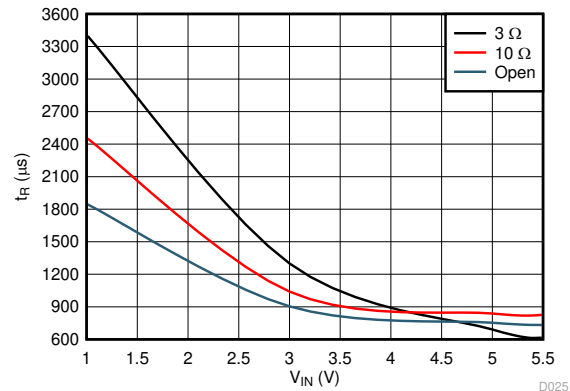

$C_L = 100 \mu\text{F}$ TPS22916C TPS22916CN TPS22916CL

图 6-30. Slow Rise Time vs Load Resistance

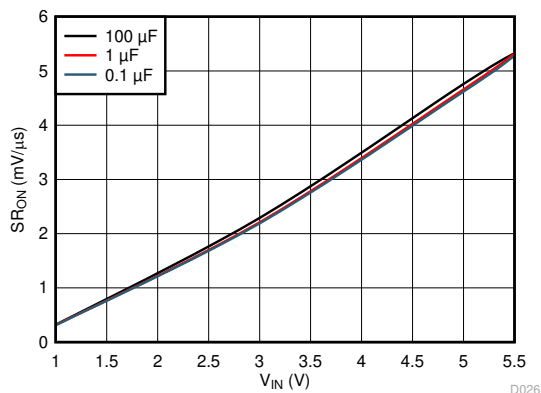

$R_L = 10 \Omega$ TPS22916C TPS22916CN TPS22916CL

图 6-31. Slow Slew Rate vs Load Capacitance

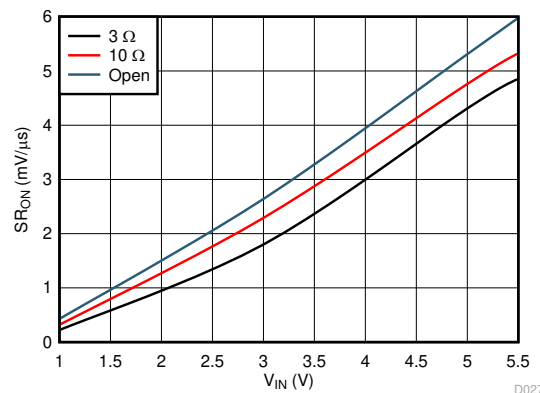

$C_L = 100 \mu\text{F}$ TPS22916C TPS22916CN TPS22916CL

图 6-32. Slow Slew Rate vs Load Resistance

6.7.2 Typical Switching Characteristics (continued)

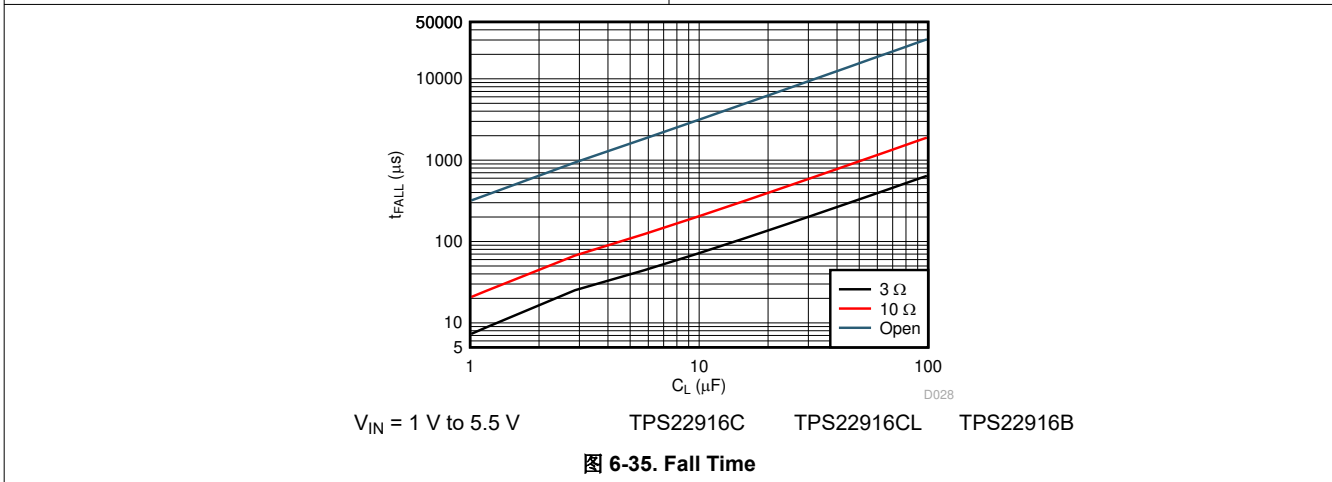
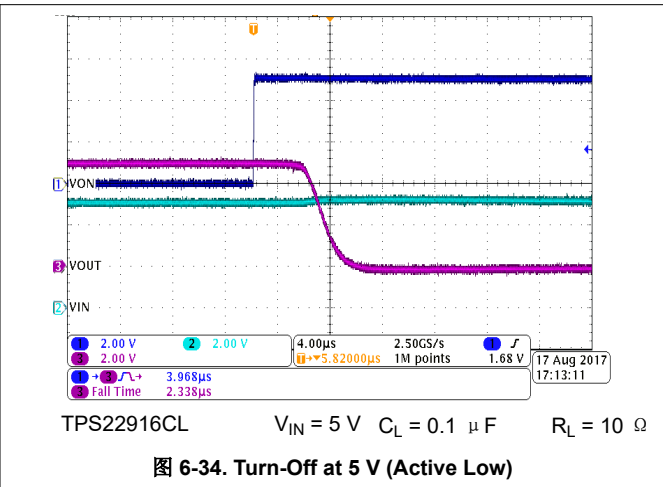
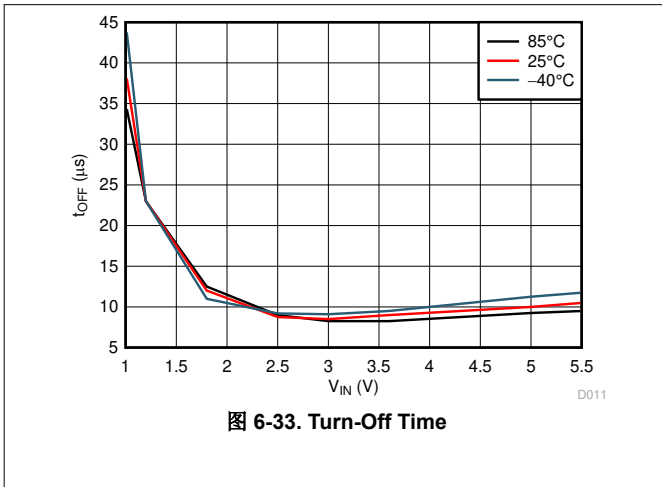

7 Parameter Measurement Information

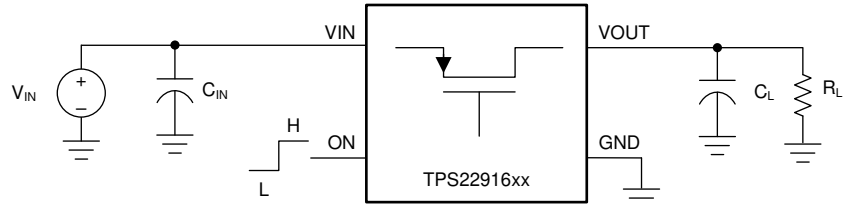

Copyright © 2017, Texas Instruments Incorporated

图 7-1. TPS22916 Test Circuit



图 7-2. TPS22916 Timing Waveform

8 Detailed Description

8.1 Overview

This family of devices are single channel, 2-A load switches in ultra-small, space saving 4-pin WCSP package. These devices implement a low resistance P-channel MOSFET with a controlled rise time for applications that must limit inrush current.

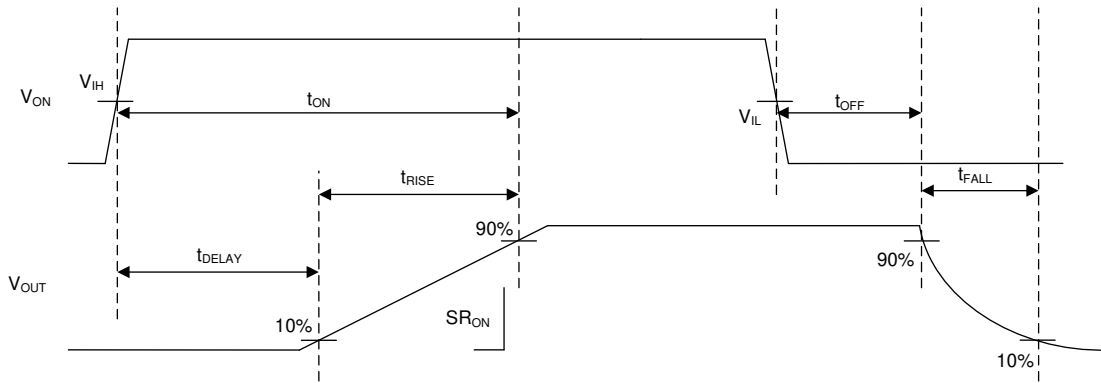
These devices are designed to have very low leakage current during OFF state. This design prevents downstream circuits from pulling high standby current from the supply. Integrated control logic, driver, power supply, and output discharge FET eliminates the need for additional external components, which reduces solution size and BOM count.

8.2 Functional Block Diagram

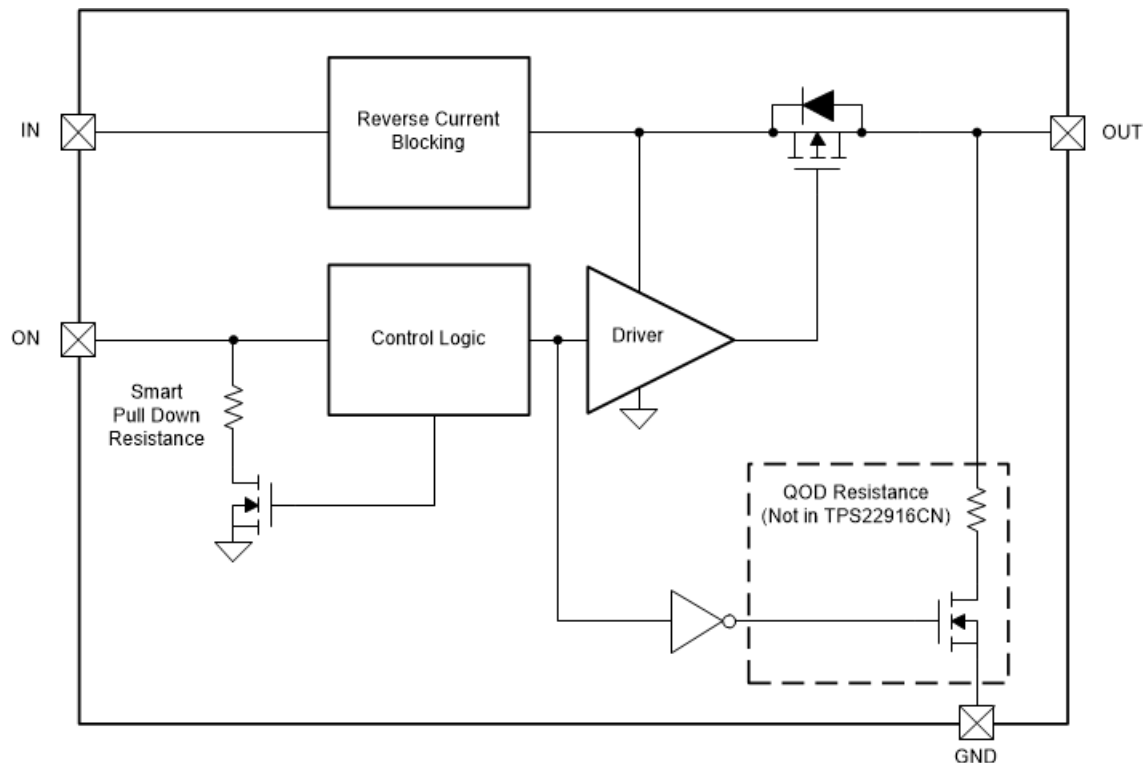

8.3 Feature Description

8.3.1 On and Off Control

The ON pin controls the state of the switch. The ON pin is compatible with standard GPIO logic threshold. the pin can be used with any microcontroller with 1.2-V, 1.8-V, 2.5-V, 3.3-V, or 5.5-V GPIO.

8.3.2 Fall Time (t_{FALL}) and Quick Output Discharge (QOD)

The TPS22916B, TPS22916BL, TPS22916C, and TPS22916CL include a Quick Output Discharge feature. When the switch is disabled, a discharge resistor is connected between VOUT and GND. This resistor has a typical value of QOD and prevents the output from floating while the switch is disabled.

As load capacitance and load resistance increase: t_{FALL} increases. The larger the load resistance or load capacitance is, the longer it takes to discharge the capacitor, resulting in a longer fall time.

The output fall time is determined by how quickly the load capacitance is discharged and can be found using 方程式 1 .

$$t_{FALL} = - (R_{DIS}) \times C_L \times \ln (V_{10\%} / V_{90\%}) \quad (1)$$

Where

- $V_{10\%}$ is 10% of the initial output voltage
- $V_{90\%}$ is 90% of the initial output voltage
- R_{DIS} is the result of the QOD resistance in parallel with the Load Resistance R_L
- C_L is the load capacitance

With the Quick Output Discharge feature, the QOD resistance is in parallel with R_L . This provides a lower total load resistance as seen from the load capacitance which discharges the capacitance faster resulting in a smaller t_{FALL} .

8.3.3 Full-Time Reverse Current Blocking

In a scenario where the device is enabled and V_{OUT} is greater than V_{IN} there is potential for reverse current to flow through the pass FET or the body diode. When the reverse current threshold (I_{RCB}) is exceeded, the switch is disabled within t_{RCB} . The switch remains off and block reverse current as long as the reverse voltage condition exists. After V_{OUT} has dropped below the V_{RCB} release threshold the TPS22916xx turns back on with slew rate control.

8.4 Device Functional Modes

表 8-1 describes the state for each variant as determined by the ON pin.

表 8-1. Device Function Table

ON	TPS22916B	TPS22916BL	TPS22916C	TPS22916CN	TPS22916CL	TPS22916CNL
$\leq V_{IL}$	Disabled	Enabled	Disabled	Disabled	Enabled	Enabled
$\geq V_{IH}$	Enabled	Disabled	Enabled	Enabled	Disabled	Disabled

表 8-2 shows when QOD is active for each variant.

表 8-2. QOD Function Table

Device	TPS22916B	TPS22916BL	TPS22916C	TPS22916CN	TPS22916CL	TPS22916CNL
Enabled	No	No	No	No	No	No
Disabled	Yes	Yes	Yes	No	Yes	No

表 8-3 shows when the ON pin smart pulldown is active.

表 8-3. Smart-ON Pulldown

V_{ON}	Pulldown
$\leq V_{IL}$	Connected
$\geq V_{IH}$	Disconnected

9 Application and Implementation

备注

以下应用部分中的信息不属于 TI 器件规格的范围，TI 不担保其准确性和完整性。TI 的客户应负责确定器件是否适用于其应用。客户应验证并测试其设计，以确保系统功能。

9.1 Application Information

This section highlights some of the design considerations when implementing this device in various applications. A PSPICE model for this device is also available in the product page of this device.

9.2 Typical Application

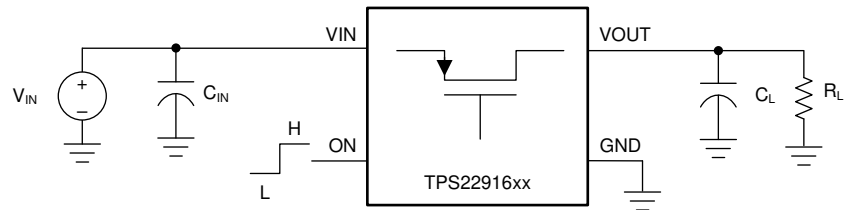

Copyright © 2017, Texas Instruments Incorporated

图 9-1. Typical Application

9.2.1 Design Requirements

For this design example, below, use the input parameters shown in 表 9-1.

表 9-1. Design Parameters

Design Parameter	Example Value
Input voltage (V_{IN})	3.6 V
Load capacitance (C_L)	47 μ F
Maximum inrush current (I_{RUSH})	300 mA

9.2.2 Detailed Design Procedure

9.2.2.1 Maximum Inrush Current

When the switch is enabled, the output capacitors must be charged up from 0 V to V_{IN} voltage. This charge arrives in the form of inrush current. Inrush current can be calculated using the following equation:

$$I_{RUSH} = C_L \times SR_{ON} \quad (2)$$

$$I_{RUSH} = 47 \mu\text{F} \times 3.2 \text{ mV}/\mu\text{s} \quad (3)$$

$$I_{RUSH} = 150 \text{ mA} \quad (4)$$

The TPS22916x offers multiple rise time options to control the inrush current during turn-on. The appropriate device can be selected based upon the maximum acceptable slew rate which can be calculated using the design requirements and the inrush current equation. In this case, the TPS22916C provides a slew rate slow enough to limit the inrush current to the desired amount.

9.2.3 Application Curve



图 9-2. Inrush Current

10 Power Supply Recommendations

The device is designed to operate with a V_{IN} range of 1 V to 5.5 V. The V_{IN} power supply must be well regulated and placed as close to the device terminal as possible. The power supply must be able to withstand all transient load current steps. In most situations, using an input capacitance (C_{IN}) of 1 μF is sufficient to prevent the supply voltage from dipping when the switch is turned on. In cases where the power supply is slow to respond to a large transient current or large load current step, additional bulk capacitance can be required on the input.

11 Layout

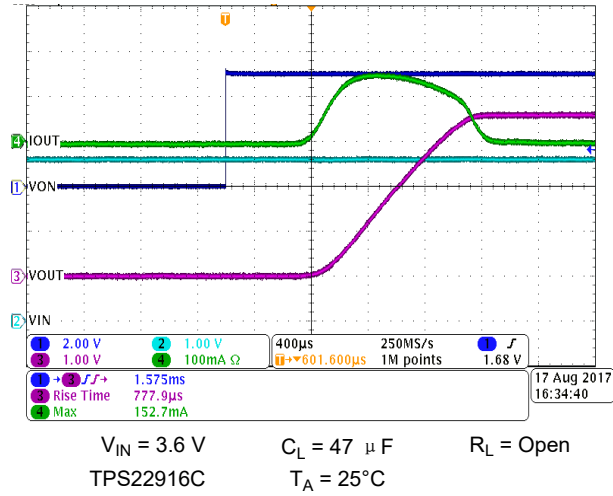
11.1 Layout Guidelines

For best performance, all traces must be as short as possible. To be most effective, the input and output capacitors must be placed close to the device to minimize the effects that parasitic trace inductances can have on normal operation. Using wide traces for VIN, VOUT, and GND helps minimize the parasitic electrical effects.

11.2 Layout Example

方程式 3 shows an example for these devices. Notice the connection to system ground between the V_{OUT} Bypass Capacitor ground and the GND pin of the load switch,. This connection creates a ground barrier which helps to reduce the ground noise seen by the device.



图 11-1. TPS22916xx Layout

11.3 Thermal Considerations

The maximum IC junction temperature must be restricted to 125°C under normal operating conditions. To calculate the maximum allowable dissipation, P_{D(max)} for a given output current and ambient temperature, use 方程式 5 as a guideline:

$$P_{D(MAX)} = \frac{T_{J(MAX)} - T_A}{R_{\theta JA}} \quad (5)$$

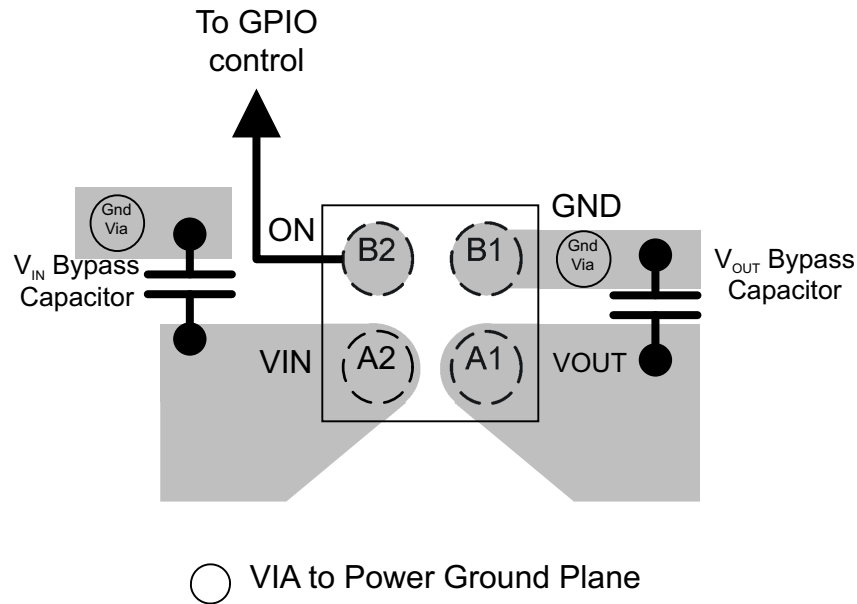
Where,

P_{D(max)} = maximum allowable power dissipation

T_{J(max)} = maximum allowable junction temperature

T_A = ambient temperature for the device

θ_{JA} = junction to air thermal impedance. See the [Thermal Information](#) section.

12 Device and Documentation Support

12.1 Documentation Support

12.1.1 Related Documentation

For related documentation see the following:

Texas Instruments, [TPS22916 Load Switch Evaluation Module User's Guide](#)

12.2 接收文档更新通知

要接收文档更新通知，请导航至 ti.com 上的器件产品文件夹。点击 [订阅更新](#) 进行注册，即可每周接收产品信息更改摘要。有关更改的详细信息，请查看任何已修订文档中包含的修订历史记录。

12.3 支持资源

[TI E2E™ 支持论坛](#) 是工程师的重要参考资料，可直接从专家获得快速、经过验证的解答和设计帮助。搜索现有解答或提出自己的问题可获得所需的快速设计帮助。

链接的内容由各个贡献者“按原样”提供。这些内容并不构成 TI 技术规范，并且不一定反映 TI 的观点；请参阅 TI 的 [《使用条款》](#)。

12.4 Trademarks

TI E2E™ is a trademark of Texas Instruments.

所有商标均为其各自所有者的财产。

12.5 Electrostatic Discharge Caution



This integrated circuit can be damaged by ESD. Texas Instruments recommends that all integrated circuits be handled with appropriate precautions. Failure to observe proper handling and installation procedures can cause damage.

ESD damage can range from subtle performance degradation to complete device failure. Precision integrated circuits may be more susceptible to damage because very small parametric changes could cause the device not to meet its published specifications.

12.6 术语表

[TI 术语表](#) 本术语表列出并解释了术语、首字母缩略词和定义。

13 Mechanical, Packaging, and Orderable Information

The following pages include mechanical, packaging, and orderable information. This information is the most current data available for the designated devices. This data is subject to change without notice and revision of this document. For browser-based versions of this data sheet, refer to the left-hand navigation.

13.1 Tape and Reel Information

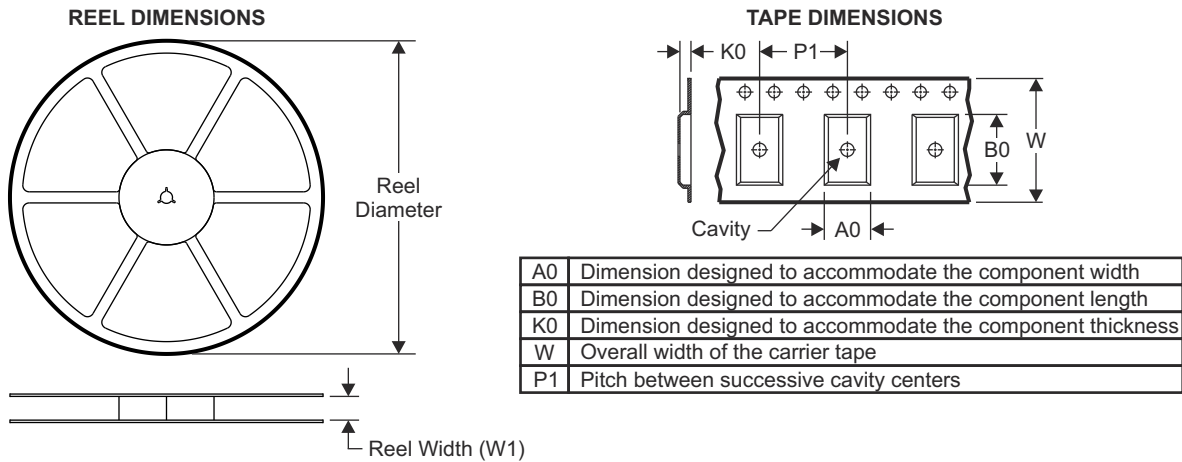

QUADRANT ASSIGNMENTS FOR PIN 1 ORIENTATION IN TAPE

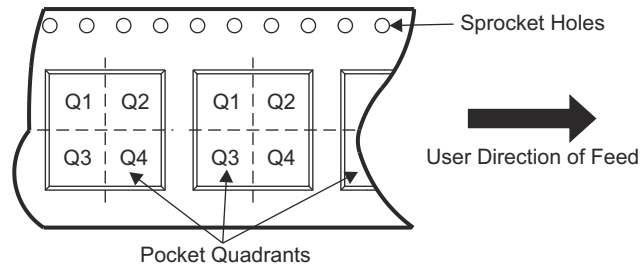

Device	Package Type	Package Drawing	Pins	SPQ	Reel Diameter (mm)	Reel Width W1 (mm)	A0 (mm)	B0 (mm)	K0 (mm)	P1 (mm)	W (mm)	Pin1 Quadrant
TPS22916BYFPR	DSBGA	YFP	4	3000	180.0	8.4	0.86	0.86	0.59	4.0	8.0	Q1
TPS22916BYFPT	DSBGA	YFP	4	250	180.0	8.4	0.86	0.86	0.59	4.0	8.0	Q1
TPS22916CLYFPR	DSBGA	YFP	4	3000	180.0	8.4	0.86	0.86	0.59	4.0	8.0	Q1
TPS22916CLYFPT	DSBGA	YFP	4	250	180.0	8.4	0.86	0.86	0.59	4.0	8.0	Q1
TPS22916CNYFPR	DSBGA	YFP	4	3000	180.0	8.4	0.86	0.86	0.59	4.0	8.0	Q1
TPS22916CNYFPT	DSBGA	YFP	4	250	180.0	8.4	0.86	0.86	0.59	4.0	8.0	Q1
TPS22916CYFPR	DSBGA	YFP	4	3000	180.0	8.4	0.86	0.86	0.59	4.0	8.0	Q1
TPS22916CYFPT	DSBGA	YFP	4	250	180.0	8.4	0.86	0.86	0.59	4.0	8.0	Q1
TPS22916CNLYFPR	DSBGA	YFP	4	3000	180.0	8.4	0.86	0.86	0.59	4.0	8.0	Q1
TPS22916BLYFPR	DSBGA	YFP	4	3000	180.0	8.4	0.86	0.86	0.59	4.0	8.0	Q1

TAPE AND REEL BOX DIMENSIONS

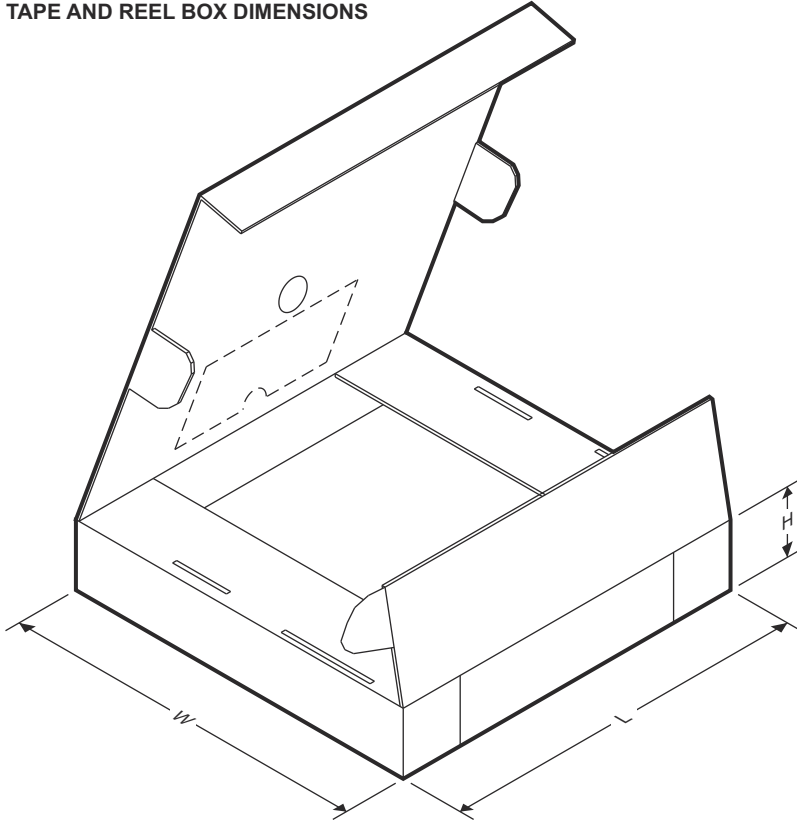

Device	Package Type	Package Drawing	Pins	SPQ	Length (mm)	Width (mm)	Height (mm)
TPS22916BYFPR	DSBGA	YFP	4	3000	182.0	182.0	20.0
TPS22916BYFPT	DSBGA	YFP	4	250	182.0	182.0	20.0
TPS22916CLYFPR	DSBGA	YFP	4	3000	182.0	182.0	20.0
TPS22916CLYFPT	DSBGA	YFP	4	250	182.0	182.0	20.0
TPS22916CNYFPR	DSBGA	YFP	4	3000	182.0	182.0	20.0
TPS22916CNYFPT	DSBGA	YFP	4	250	182.0	182.0	20.0
TPS22916CYFPR	DSBGA	YFP	4	3000	182.0	182.0	20.0
TPS22916CYFPT	DSBGA	YFP	4	250	182.0	182.0	20.0
TPS22916CNLYFPR	DSBGA	YFP	4	3000	182.0	182.0	20.0
TPS22916BLYFPR	DSBGA	YFP	4	3000	182.0	182.0	20.0



YFP0004

PACKAGE OUTLINE

DSBGA - 0.5 mm max height

DIE SIZE BALL GRID ARRAY

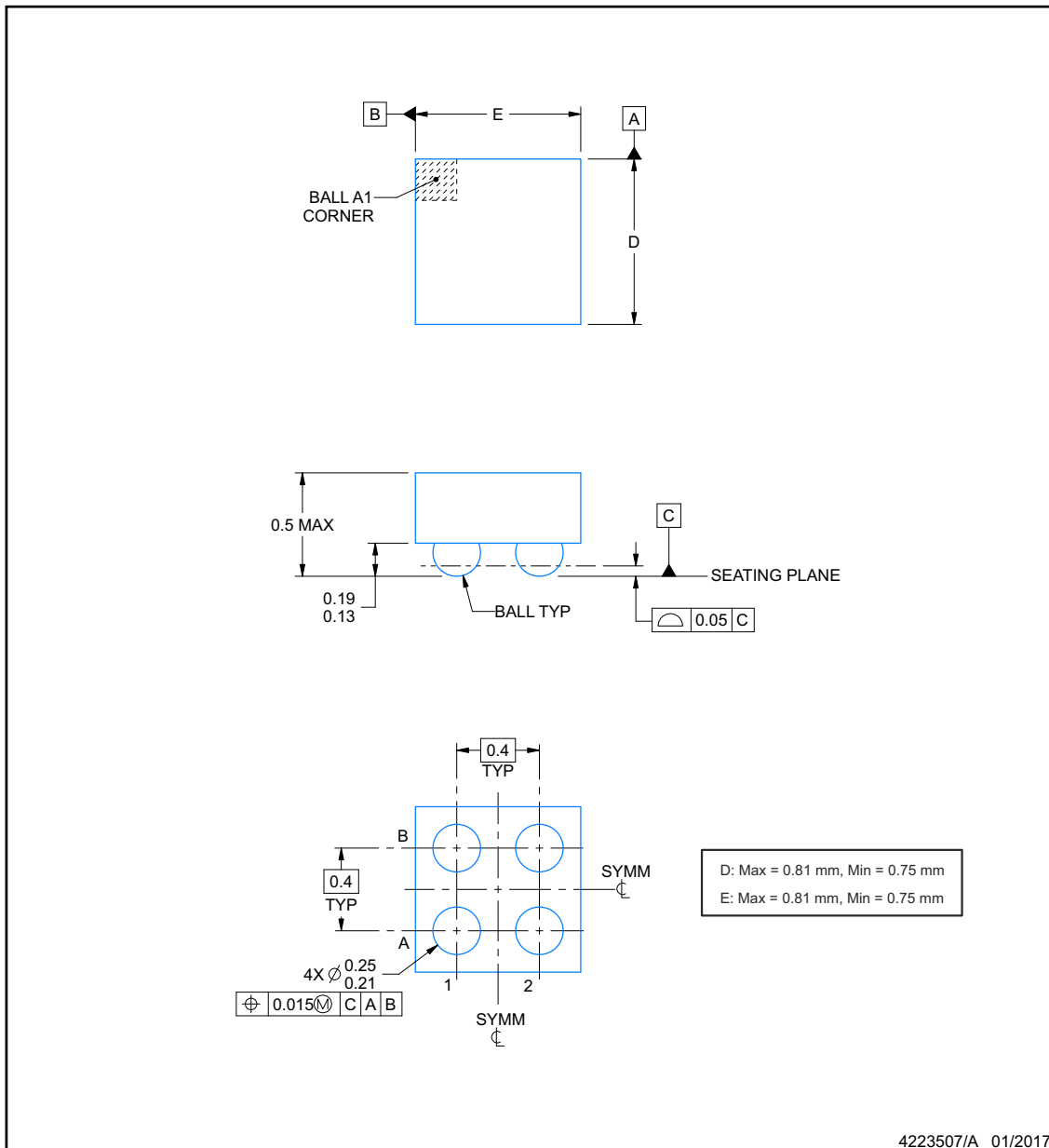

NOTES:

1. All linear dimensions are in millimeters. Any dimensions in parenthesis are for reference only. Dimensioning and tolerancing per ASME Y14.5M.
2. This drawing is subject to change without notice.

EXAMPLE BOARD LAYOUT

YFP0004

DSBGA - 0.5 mm max height

DIE SIZE BALL GRID ARRAY

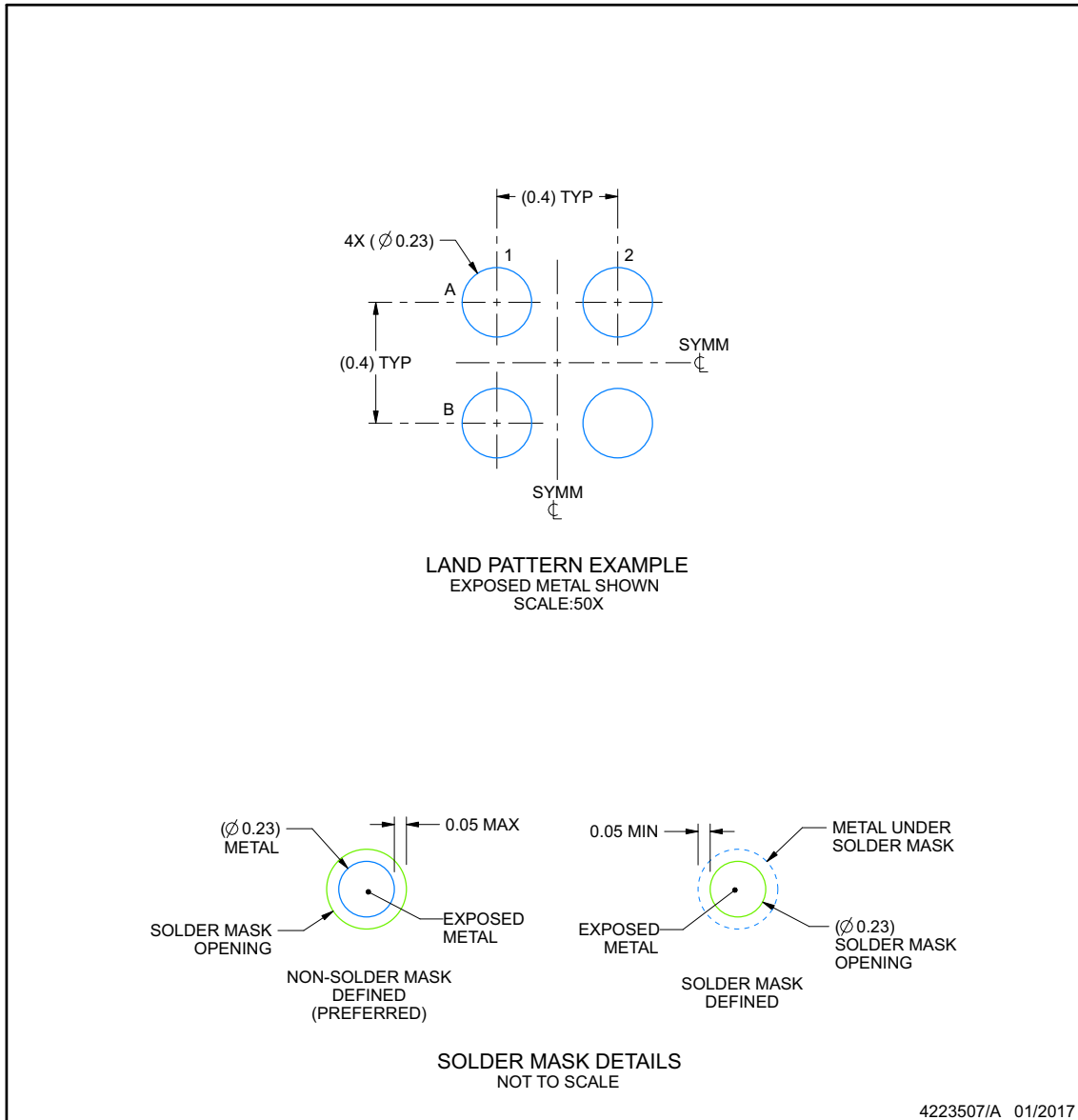

NOTES: (continued)

- Final dimensions may vary due to manufacturing tolerance considerations and also routing constraints. For more information, see Texas Instruments literature number SNVA009 (www.ti.com/lit/snva009).

EXAMPLE STENCIL DESIGN

YFP0004

DSBGA - 0.5 mm max height

DIE SIZE BALL GRID ARRAY

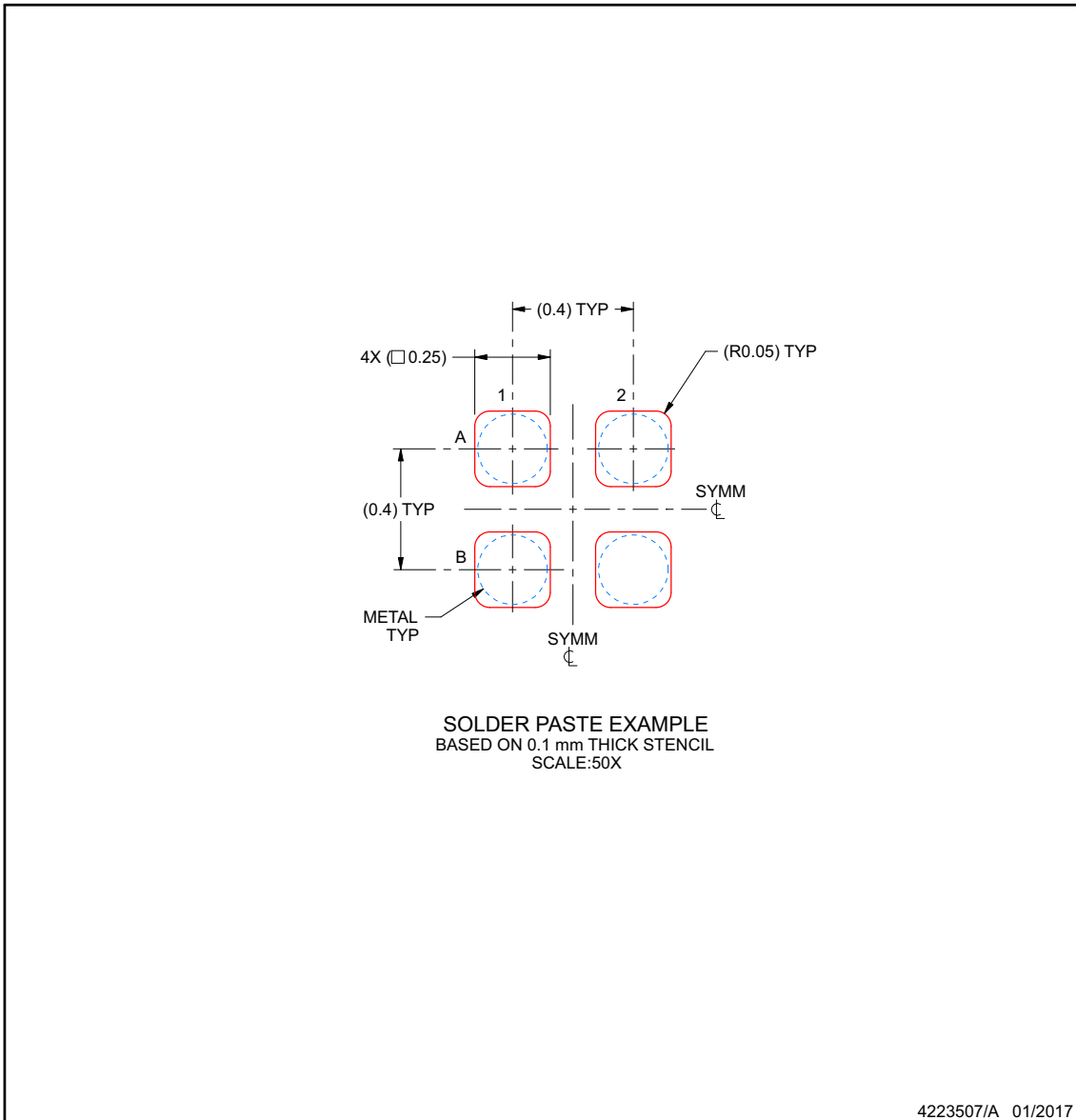

NOTES: (continued)

4. Laser cutting apertures with trapezoidal walls and rounded corners may offer better paste release.

PACKAGING INFORMATION

Orderable Device	Status (1)	Package Type	Package Drawing	Pins	Package Qty	Eco Plan (2)	Lead finish/ Ball material (6)	MSL Peak Temp (3)	Op Temp (°C)	Device Marking (4/5)	Samples
TPS22916BLYFPR	ACTIVE	DSBGA	YFP	4	3000	RoHS & Green	SNAGCU	Level-1-260C-UNLIM	-40 to 85	Q	Samples
TPS22916BYFPR	ACTIVE	DSBGA	YFP	4	3000	RoHS & Green	SAC396 SNAGCU	Level-1-260C-UNLIM	-40 to 85	(BA, R)	Samples
TPS22916BYFPT	ACTIVE	DSBGA	YFP	4	250	RoHS & Green	SAC396 SNAGCU	Level-1-260C-UNLIM	-40 to 85	(BA, R)	Samples
TPS22916CLYFPR	ACTIVE	DSBGA	YFP	4	3000	RoHS & Green	SAC396	Level-1-260C-UNLIM	-40 to 85	B9	Samples
TPS22916CLYFPT	ACTIVE	DSBGA	YFP	4	250	RoHS & Green	SAC396	Level-1-260C-UNLIM	-40 to 85	B9	Samples
TPS22916CNLYFPR	ACTIVE	DSBGA	YFP	4	3000	RoHS & Green	SNAGCU	Level-1-260C-UNLIM	-40 to 85	S	Samples
TPS22916CNYFPR	ACTIVE	DSBGA	YFP	4	3000	RoHS & Green	SAC396	Level-1-260C-UNLIM	-40 to 85	B8	Samples
TPS22916CNYFPT	ACTIVE	DSBGA	YFP	4	250	RoHS & Green	SAC396	Level-1-260C-UNLIM	-40 to 85	B8	Samples
TPS22916CYFPR	ACTIVE	DSBGA	YFP	4	3000	RoHS & Green	SAC396	Level-1-260C-UNLIM	-40 to 85	B7	Samples
TPS22916CYFPT	ACTIVE	DSBGA	YFP	4	250	RoHS & Green	SAC396	Level-1-260C-UNLIM	-40 to 85	B7	Samples

(1) The marketing status values are defined as follows:

ACTIVE: Product device recommended for new designs.

LIFEBUY: TI has announced that the device will be discontinued, and a lifetime-buy period is in effect.

NRND: Not recommended for new designs. Device is in production to support existing customers, but TI does not recommend using this part in a new design.

PREVIEW: Device has been announced but is not in production. Samples may or may not be available.

OBSELETE: TI has discontinued the production of the device.

(2) **RoHS:** TI defines "RoHS" to mean semiconductor products that are compliant with the current EU RoHS requirements for all 10 RoHS substances, including the requirement that RoHS substance do not exceed 0.1% by weight in homogeneous materials. Where designed to be soldered at high temperatures, "RoHS" products are suitable for use in specified lead-free processes. TI may reference these types of products as "Pb-Free".

RoHS Exempt: TI defines "RoHS Exempt" to mean products that contain lead but are compliant with EU RoHS pursuant to a specific EU RoHS exemption.

Green: TI defines "Green" to mean the content of Chlorine (Cl) and Bromine (Br) based flame retardants meet JS709B low halogen requirements of <=1000ppm threshold. Antimony trioxide based flame retardants must also meet the <=1000ppm threshold requirement.

(3) MSL, Peak Temp. - The Moisture Sensitivity Level rating according to the JEDEC industry standard classifications, and peak solder temperature.

(4) There may be additional marking, which relates to the logo, the lot trace code information, or the environmental category on the device.

⁽⁵⁾ Multiple Device Markings will be inside parentheses. Only one Device Marking contained in parentheses and separated by a "~" will appear on a device. If a line is indented then it is a continuation of the previous line and the two combined represent the entire Device Marking for that device.

⁽⁶⁾ Lead finish/Ball material - Orderable Devices may have multiple material finish options. Finish options are separated by a vertical ruled line. Lead finish/Ball material values may wrap to two lines if the finish value exceeds the maximum column width.

Important Information and Disclaimer:The information provided on this page represents TI's knowledge and belief as of the date that it is provided. TI bases its knowledge and belief on information provided by third parties, and makes no representation or warranty as to the accuracy of such information. Efforts are underway to better integrate information from third parties. TI has taken and continues to take reasonable steps to provide representative and accurate information but may not have conducted destructive testing or chemical analysis on incoming materials and chemicals. TI and TI suppliers consider certain information to be proprietary, and thus CAS numbers and other limited information may not be available for release.

In no event shall TI's liability arising out of such information exceed the total purchase price of the TI part(s) at issue in this document sold by TI to Customer on an annual basis.

重要声明和免责声明

TI“按原样”提供技术和可靠性数据（包括数据表）、设计资源（包括参考设计）、应用或其他设计建议、网络工具、安全信息和其他资源，不保证没有瑕疵且不做任何明示或暗示的担保，包括但不限于对适销性、某特定用途方面的适用性或不侵犯任何第三方知识产权的暗示担保。

这些资源可供使用 TI 产品进行设计的熟练开发人员使用。您将自行承担以下全部责任：(1) 针对您的应用选择合适的 TI 产品，(2) 设计、验证并测试您的应用，(3) 确保您的应用满足相应标准以及任何其他功能安全、信息安全、监管或其他要求。

这些资源如有变更，恕不另行通知。TI 授权您仅可将这些资源用于研发本资源所述的 TI 产品的应用。严禁对这些资源进行其他复制或展示。您无权使用任何其他 TI 知识产权或任何第三方知识产权。您应全额赔偿因在这些资源的使用中对 TI 及其代表造成的任何索赔、损害、成本、损失和债务，TI 对此概不负责。

TI 提供的产品受 [TI 的销售条款](#) 或 [ti.com](#) 上其他适用条款/TI 产品随附的其他适用条款的约束。TI 提供这些资源并不会扩展或以其他方式更改 TI 针对 TI 产品发布的适用的担保或担保免责声明。

TI 反对并拒绝您可能提出的任何其他或不同的条款。

邮寄地址：Texas Instruments, Post Office Box 655303, Dallas, Texas 75265

Copyright © 2022，德州仪器 (TI) 公司

单击下面可查看定价，库存，交付和生命周期等信息

[>>TI\(德州仪器\)](#)