

# TPS737 1-A Low-Dropout Regulator With Reverse Current Protection

## 1 Features

- Stable with 1- $\mu$ F or larger ceramic output capacitor
- Input voltage range: 2.2 V to 5.5 V
- Ultra-low dropout voltage
  - Legacy silicon: 130 mV typical at 1 A
  - New silicon, M3 suffix: 122 mV typical at 1 A
- Excellent load transient response—even with only 1- $\mu$ F output capacitor
- NMOS topology delivers low reverse leakage current
- Initial accuracy: 1%
- Overall accuracy over line, load, and temperature
  - Legacy silicon: 3%
  - New silicon, M3 suffix: 1.5%
- Less than 20 nA typical  $I_Q$  in shutdown mode
- Thermal shutdown and current limit for fault protection
- Available in multiple output voltage versions:
  - Adjustable output: 1.20 V to 5.5 V
  - Custom outputs available using factory package-level programming

## 2 Applications

- Point-of-load regulation for DSPs, [FPGAs](#), ASICs, and microprocessors
- Post-regulation for [switching supplies](#)
- [Portable and battery-powered equipment](#)

## 3 Description

The TPS737 linear low-dropout (LDO) voltage regulator uses an NMOS pass transistor in a voltage-follower configuration. This topology is relatively insensitive to the output capacitor value and ESR, allowing for a wide variety of load configurations. Load transient response is excellent, even with a small 1- $\mu$ F ceramic output capacitor. The NMOS topology also allows for very low dropout.

The TPS737 uses an advanced BiCMOS process to yield high precision while delivering very low dropout voltages and low ground pin current. Part numbers with the M3 suffix use an updated design on the latest TI process technology. Current consumption, when not enabled, is less than 20 nA and is designed for portable applications. This device is protected by thermal shutdown and foldback current limit.

For applications that require higher output voltage accuracy, consider TI's [TPS7A37](#) 1% overall accuracy, 1-A low-dropout voltage regulator.

### Package Information

| PART NUMBER | PACKAGE <sup>(1)</sup> | PACKAGE SIZE <sup>(2)</sup> |
|-------------|------------------------|-----------------------------|
| TPS737      | DRB (VSON, 8)          | 3 mm × 3 mm                 |
|             | DCQ (SOT-223, 6)       | 6.5 mm × 7.06 mm            |
|             | DRV (WSON, 6)          | 2 mm × 2 mm                 |

(1) For more information, see the [Mechanical, Packaging, and Orderable Information](#).

(2) The package size (length × width) is a nominal value and includes pins, where applicable.

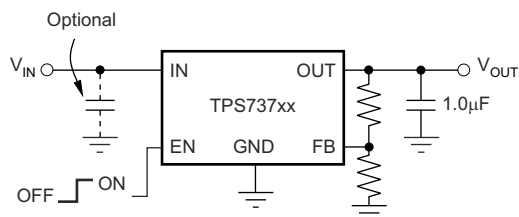

**Typical Application Circuit**



An IMPORTANT NOTICE at the end of this data sheet addresses availability, warranty, changes, use in safety-critical applications, intellectual property matters and other important disclaimers. PRODUCTION DATA.

## Table of Contents

|                                                |    |                                                                  |    |
|------------------------------------------------|----|------------------------------------------------------------------|----|
| <b>1 Features</b> .....                        | 1  | 7.1 Application Information.....                                 | 18 |
| <b>2 Applications</b> .....                    | 1  | 7.2 Typical Application.....                                     | 18 |
| <b>3 Description</b> .....                     | 1  | 7.3 Best Design Practices.....                                   | 20 |
| <b>4 Pin Configuration and Functions</b> ..... | 3  | 7.4 Power Supply Recommendations.....                            | 20 |
| <b>5 Specifications</b> .....                  | 4  | 7.5 Layout.....                                                  | 20 |
| 5.1 Absolute Maximum Ratings.....              | 4  | <b>8 Device and Documentation Support</b> .....                  | 25 |
| 5.2 ESD Ratings.....                           | 4  | 8.1 Device Support.....                                          | 25 |
| 5.3 Recommended Operating Conditions.....      | 4  | 8.2 Documentation Support.....                                   | 25 |
| 5.4 Thermal Information.....                   | 5  | 8.3 Receiving Notification of Documentation Updates....          | 25 |
| 5.5 Electrical Characteristics.....            | 6  | 8.4 Support Resources.....                                       | 25 |
| 5.6 Typical Characteristics.....               | 7  | 8.5 Trademarks.....                                              | 25 |
| <b>6 Detailed Description</b> .....            | 15 | 8.6 Electrostatic Discharge Caution.....                         | 26 |
| 6.1 Overview.....                              | 15 | 8.7 Glossary.....                                                | 26 |
| 6.2 Functional Block Diagrams .....            | 15 | <b>9 Revision History</b> .....                                  | 26 |
| 6.3 Feature Description.....                   | 16 | <b>10 Mechanical, Packaging, and Orderable Information</b> ..... | 26 |
| 6.4 Device Functional Modes.....               | 17 |                                                                  |    |
| <b>7 Application and Implementation</b> .....  | 18 |                                                                  |    |

## 4 Pin Configuration and Functions

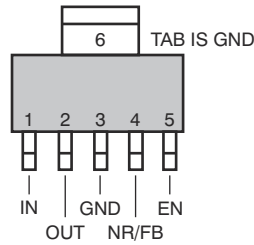

Figure 4-1. DCQ Package, 6-Pin SOT-223 (Top View)

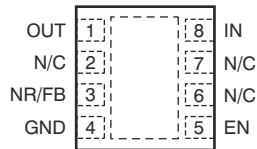

Figure 4-2. DRB Package, 8-Pin VSON (Top View)

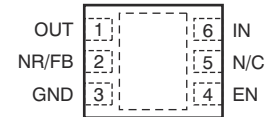

Figure 4-3. DRV Package<sup>(A)</sup>, 6-Pin WSON (Top View)

A. Power dissipation can limit operating range. Check the *Thermal Information* table.

Table 4-1. Pin Functions

| NAME | PIN     |         |        | I/O | DESCRIPTION                                                                                                                                                                                                                                                |
|------|---------|---------|--------|-----|------------------------------------------------------------------------------------------------------------------------------------------------------------------------------------------------------------------------------------------------------------|
|      | SOT-223 | VSON    | WSON   |     |                                                                                                                                                                                                                                                            |
| IN   | 1       | 8       | 6      | I   | Unregulated input supply                                                                                                                                                                                                                                   |
| GND  | 3, 6    | 4, Pad  | 3, Pad | —   | Ground                                                                                                                                                                                                                                                     |
| EN   | 5       | 5       | 4      | I   | Driving the enable pin (EN) high turns on the regulator. Driving this pin low puts the regulator into shutdown mode. See the <i>Enable Pin and Shutdown</i> section for more details. EN must not be left floating and can be connected to IN if not used. |
| NR   | 4       | 3       | 2      | —   | Fixed voltage versions only—connecting an external capacitor to this pin bypasses noise generated by the internal band gap, reducing output noise to very low levels.                                                                                      |
| FB   | 4       | 3       | 2      | I   | Adjustable voltage version only—this is the input to the control loop error amplifier, and is used to set the output voltage of the device.                                                                                                                |
| OUT  | 2       | 1       | 1      | O   | Regulator output. A 1.0- $\mu$ F or larger capacitor of any type is required for stability.                                                                                                                                                                |
| NC   | —       | 2, 6, 7 | 5      | —   | Not connected                                                                                                                                                                                                                                              |

## 5 Specifications

### 5.1 Absolute Maximum Ratings

over operating junction temperature range (unless otherwise noted) <sup>(1)</sup>

|                                    |                    | MIN                            | MAX | UNIT |
|------------------------------------|--------------------|--------------------------------|-----|------|
| Voltage                            | $V_{IN}$           | -0.3                           | 6   | V    |
|                                    | $V_{EN}$           | -0.3                           | 6   |      |
|                                    | $V_{OUT}$          | -0.3                           | 5.5 |      |
|                                    | $V_{NR}, V_{FB}$   | -0.3                           | 6   |      |
| Peak output current                | $I_{OUT}$          | Internally limited             |     |      |
| Output short-circuit duration      |                    | Indefinite                     |     |      |
| Continuous total power dissipation | $P_{DISS}$         | See <i>Thermal Information</i> |     |      |
| Temperature                        | Junction, $T_J$    | -55                            | 150 | °C   |
|                                    | Storage, $T_{stg}$ | -65                            | 150 |      |

- (1) Stresses beyond those listed under *Absolute Maximum Ratings* may cause permanent damage to the device. These are stress ratings only, which do not imply functional operation of the device at these or any other conditions beyond those indicated under *Recommended Operating Conditions*. Exposure to absolute-maximum-rated conditions for extended periods may affect device reliability.

### 5.2 ESD Ratings

|             |                         |                                                                                          | VALUE | UNIT |
|-------------|-------------------------|------------------------------------------------------------------------------------------|-------|------|
| $V_{(ESD)}$ | Electrostatic discharge | Human body model (HBM), per ANSI/ESDA/JEDEC JS-001, all pins <sup>(1)</sup>              | ±2000 | V    |
|             |                         | Charged device model (CDM), per JEDEC specification JESD22-C101, all pins <sup>(2)</sup> | ±500  |      |

- (1) JEDEC document JEP155 states that 500-V HBM allows safe manufacturing with a standard ESD control process.  
 (2) JEDEC document JEP157 states that 250-V CDM allows safe manufacturing with a standard ESD control process.

### 5.3 Recommended Operating Conditions

over operating junction temperature range (unless otherwise noted)

|           |                                | MIN | NOM | MAX | UNIT |
|-----------|--------------------------------|-----|-----|-----|------|
| $V_{IN}$  | Input supply voltage           | 2.2 |     | 5.5 | V    |
| $I_{OUT}$ | Output current                 | 0   |     | 1   | A    |
| $T_J$     | Operating junction temperature | -40 |     | 125 | °C   |

## 5.4 Thermal Information

| THERMAL METRIC <sup>(1)</sup> |                                                             | TPS737 <sup>(2)</sup> |                  |                  |                              | UNIT |
|-------------------------------|-------------------------------------------------------------|-----------------------|------------------|------------------|------------------------------|------|
|                               |                                                             | DRB<br>(VSON)         | DRB<br>(VSON) M3 | DCQ<br>(SOT-223) | DRV<br>(WSON) <sup>(3)</sup> |      |
|                               |                                                             | 8 PINS                | 8 PINS           | 6 PINS           | 6 PINS                       |      |
| R <sub>θJA</sub>              | Junction-to-ambient thermal resistance <sup>(4)</sup>       | 49.5                  | 47.7             | 53.1             | 67.2                         | °C/W |
| R <sub>θJC(top)</sub>         | Junction-to-case (top) thermal resistance <sup>(5)</sup>    | 58.9                  | 68.9             | 35.2             | 87.6                         | °C/W |
| R <sub>θJB</sub>              | Junction-to-board thermal resistance <sup>(6)</sup>         | 25.1                  | 20.6             | 7.8              | 36.8                         | °C/W |
| ψ <sub>JT</sub>               | Junction-to-top characterization parameter <sup>(7)</sup>   | 1.7                   | 3.4              | 2.9              | 1.8                          | °C/W |
| ψ <sub>JB</sub>               | Junction-to-board characterization parameter <sup>(8)</sup> | 25.2                  | 20.6             | 7.7              | 37.2                         | °C/W |
| R <sub>θJC(bot)</sub>         | Junction-to-case (bottom) thermal resistance <sup>(9)</sup> | 8.6                   | 3.5              | N/A              | 7.7                          | °C/W |

- (1) For more information about traditional and new thermal metrics, see the [Semiconductor and IC package thermal metrics application note](#).
- (2) Thermal data for the DRB, DCQ, and DRV packages are derived by thermal simulations based on JEDEC-standard methodology as specified in the JESD51 series. The following assumptions are used in the simulations:
  - a. i. DRB: The exposed pad is connected to the PCB ground layer through a 2 × 2 thermal via array.
  - ii. DCQ: The exposed pad is connected to the PCB ground layer through a 3 × 2 thermal via array.
  - iii. DRV: The exposed pad is connected to the PCB ground layer through a 2 × 2 thermal via array. Due to size limitation of thermal pad, 0.8-mm pitch array is used which is off the JEDEC standard.
  - b. The top copper layer has a detailed copper trace pattern. The bottom copper layer is assumed to have a 20% thermal conductivity of copper, representing a 20% copper coverage.
  - c. These data were generated with only a single device at the center of a JEDEC high-K (2s2p) board with 3-inch × 3-inch copper area. To understand the effects of the copper area on thermal performance, see the [Power Dissipation](#) and [Estimating Junction Temperature](#) sections of this data sheet.
- (3) Power dissipation can limit operating range.
- (4) The junction-to-ambient thermal resistance under natural convection is obtained in a simulation on a JEDEC-standard, high-K board, as specified in JESD51-7, in an environment described in JESD51-2a.
- (5) The junction-to-case (top) thermal resistance is obtained by simulating a cold plate test on the top of the package. No specific JEDEC-standard test exists, but a close description can be found in the ANSI SEMI standard G30-88.
- (6) The junction-to-board thermal resistance is obtained by simulating in an environment with a ring cold plate fixture to control the PCB temperature, as described in JESD51-8.
- (7) The junction-to-top characterization parameter, ψ<sub>JT</sub>, estimates the junction temperature of a device in a real system and is extracted from the simulation data to obtain R<sub>θJA</sub> using a procedure described in JESD51-2a (sections 6 and 7).
- (8) The junction-to-board characterization parameter, ψ<sub>JB</sub>, estimates the junction temperature of a device in a real system and is extracted from the simulation data to obtain R<sub>θJA</sub> using a procedure described in JESD51-2a (sections 6 and 7).
- (9) The junction-to-case (bottom) thermal resistance is obtained by simulating a cold plate test on the exposed (power) pad. No specific JEDEC standard test exists, but a close description can be found in the ANSI SEMI standard G30-88.

## 5.5 Electrical Characteristics

over operating temperature range ( $T_J = -40^\circ\text{C}$  to  $+125^\circ\text{C}$ ),  $V_{IN} = V_{OUT(nom)} + 1\text{ V}^{(1)}$ ,  $I_{OUT} = 10\text{ mA}$ ,  $V_{EN} = 2.2\text{ V}$ , and  $C_{OUT} = 2.2\text{ }\mu\text{F}$  (unless otherwise noted); typical values are at  $T_J = 25^\circ\text{C}$

| PARAMETER                        |                                                                                                                                  | TEST CONDITIONS                                                                                                  | MIN                                                                                                                                                                                  | TYP                 | MAX            | UNIT                |   |   |
|----------------------------------|----------------------------------------------------------------------------------------------------------------------------------|------------------------------------------------------------------------------------------------------------------|--------------------------------------------------------------------------------------------------------------------------------------------------------------------------------------|---------------------|----------------|---------------------|---|---|
| $V_{IN}$                         | Input voltage <sup>(1) (2)</sup>                                                                                                 |                                                                                                                  | 2.2                                                                                                                                                                                  |                     | 5.5            | V                   |   |   |
| $V_{FB}$                         | Internal reference (DCQ package)                                                                                                 | $T_J = 25^\circ\text{C}$                                                                                         | 1.198                                                                                                                                                                                | 1.204               | 1.21           | V                   |   |   |
|                                  | Internal reference (DRB and DRV packages)                                                                                        | $T_J = 25^\circ\text{C}$                                                                                         | 1.192                                                                                                                                                                                | 1.204               | 1.216          |                     |   |   |
| $V_{OUT}$                        | Output voltage (TPS73701) <sup>(3)</sup>                                                                                         |                                                                                                                  | $V_{FB}$                                                                                                                                                                             |                     | $5.5 - V_{DO}$ | V                   |   |   |
|                                  | Accuracy <sup>(1) (4)</sup>                                                                                                      | Nominal                                                                                                          | $T_J = 25^\circ\text{C}$                                                                                                                                                             | -1                  |                | 1                   | % |   |
|                                  |                                                                                                                                  |                                                                                                                  | $5.36\text{ V} < V_{IN} < 5.5\text{ V}$ , $V_{OUT} = 5.08\text{ V}$ ,<br>$10\text{ mA} < I_{OUT} < 800\text{ mA}$ ,<br>$-40^\circ\text{C} < T_J < 85^\circ\text{C}$ , TPS73701 (DCQ) |                     | -2             |                     |   | 2 |
|                                  |                                                                                                                                  | Over $V_{IN}$ , $I_{OUT}$ ,<br>and T                                                                             | $V_{OUT} + 0.5\text{ V} \leq V_{IN} \leq 5.5\text{ V}$ ;<br>$10\text{ mA} \leq I_{OUT} \leq 1\text{ A}$ , legacy silicon                                                             |                     | -3             | $\pm 0.5$           |   | 3 |
|                                  | $V_{OUT} + 0.5\text{ V} \leq V_{IN} \leq 5.5\text{ V}$ ;<br>$10\text{ mA} \leq I_{OUT} \leq 1\text{ A}$ , new silicon, M3 suffix |                                                                                                                  | -1.5                                                                                                                                                                                 | $\pm 0.5$           | 1.5            |                     |   |   |
| $\Delta V_{OUT(\Delta V_{IN})}$  | Line regulation <sup>(1)</sup>                                                                                                   | $V_{OUT(nom)} + 0.5\text{ V} \leq V_{IN} \leq 5.5\text{ V}$                                                      |                                                                                                                                                                                      | 0.01                |                | %/V                 |   |   |
| $\Delta V_{OUT(\Delta I_{OUT})}$ | Load regulation                                                                                                                  | $1\text{ mA} \leq I_{OUT} \leq 1\text{ A}$                                                                       |                                                                                                                                                                                      | 0.002               |                | %mA                 |   |   |
|                                  |                                                                                                                                  | $10\text{ mA} \leq I_{OUT} \leq 1\text{ A}$                                                                      |                                                                                                                                                                                      | 0.0005              |                |                     |   |   |
| $V_{DO}$                         | Dropout voltage <sup>(5)</sup><br>( $V_{IN} = V_{OUT(nom)} - 0.1\text{ V}$ )                                                     | $I_{OUT} = 1\text{ A}$ , legacy silicon                                                                          |                                                                                                                                                                                      | 130                 | 500            | mV                  |   |   |
|                                  |                                                                                                                                  | $I_{OUT} = 1\text{ A}$ , new silicon, M3 suffix                                                                  |                                                                                                                                                                                      | 122                 | 250            |                     |   |   |
| $Z_{OUT(DO)}$                    | Output impedance in dropout                                                                                                      | $2.2\text{ V} \leq V_{IN} \leq V_{OUT} + V_{DO}$                                                                 |                                                                                                                                                                                      | 0.25                |                | $\Omega$            |   |   |
| $I_{CL}$                         | Output current limit                                                                                                             | $V_{OUT} = 0.9 \times V_{OUT(nom)}$                                                                              | 1.05                                                                                                                                                                                 | 1.6                 | 2.2            | A                   |   |   |
| $I_{OS}$                         | Short-circuit current                                                                                                            | $V_{OUT} = 0\text{ V}$ , legacy silicon                                                                          |                                                                                                                                                                                      | 450                 |                | mA                  |   |   |
|                                  |                                                                                                                                  | $V_{OUT} = 0\text{ V}$ , new silicon, M3 suffix                                                                  |                                                                                                                                                                                      | 510                 |                |                     |   |   |
| $I_{REV}$                        | Reverse leakage current <sup>(6)</sup> ( $-I_{IN}$ )                                                                             | $V_{EN} \leq 0.5\text{ V}$ , $0\text{ V} \leq V_{IN} \leq V_{OUT}$                                               |                                                                                                                                                                                      | 0.1                 |                | $\mu\text{A}$       |   |   |
| $I_{GND}$                        | GND pin current                                                                                                                  | $I_{OUT} = 10\text{ mA}$                                                                                         |                                                                                                                                                                                      | 400                 |                | $\mu\text{A}$       |   |   |
|                                  |                                                                                                                                  | $I_{OUT} = 1\text{ A}$ , legacy silicon                                                                          |                                                                                                                                                                                      | 1300                |                |                     |   |   |
|                                  |                                                                                                                                  | $I_{OUT} = 1\text{ A}$ , new silicon, M3 suffix                                                                  |                                                                                                                                                                                      | 880                 |                |                     |   |   |
| $I_{SHDN}$                       | Shutdown current ( $I_{GND}$ )                                                                                                   | $V_{EN} \leq 0.5\text{ V}$ , $V_{OUT} \leq V_{IN} \leq 5.5$                                                      |                                                                                                                                                                                      | 20                  |                | nA                  |   |   |
| $I_{FB}$                         | FB pin current (TPS73701)                                                                                                        |                                                                                                                  |                                                                                                                                                                                      | 0.1                 | 0.6            | $\mu\text{A}$       |   |   |
| PSRR                             | Power-supply rejection ratio (ripple rejection)                                                                                  | $f = 100\text{ Hz}$ , $I_{OUT} = 1\text{ A}$                                                                     |                                                                                                                                                                                      | 58                  |                | dB                  |   |   |
|                                  |                                                                                                                                  | $f = 10\text{ kHz}$ , $I_{OUT} = 1\text{ A}$                                                                     |                                                                                                                                                                                      | 37                  |                |                     |   |   |
| $V_n$                            | Output noise voltage<br>BW = 10 Hz to 100 kHz                                                                                    | $C_{OUT} = 10\text{ }\mu\text{F}$                                                                                |                                                                                                                                                                                      | $27 \times V_{OUT}$ |                | $\mu\text{V}_{RMS}$ |   |   |
| $t_{STR}$                        | Start-up time                                                                                                                    | $V_{OUT} = 3\text{ V}$ , $R_L = 30\text{ }\Omega$ , $C_{OUT} = 1\text{ }\mu\text{F}$ ,<br>legacy silicon         |                                                                                                                                                                                      | 600                 |                | $\mu\text{s}$       |   |   |
|                                  |                                                                                                                                  | $V_{OUT} = 3\text{ V}$ , $R_L = 30\text{ }\Omega$ , $C_{OUT} = 1\text{ }\mu\text{F}$ , new<br>silicon, M3 suffix |                                                                                                                                                                                      | 431                 |                |                     |   |   |
| $V_{EN(HI)}$                     | EN pin high (enabled)                                                                                                            |                                                                                                                  | 1.7                                                                                                                                                                                  |                     | $V_{IN}$       | V                   |   |   |
| $V_{EN(LO)}$                     | EN pin low (shutdown)                                                                                                            |                                                                                                                  | 0                                                                                                                                                                                    |                     | 0.5            | V                   |   |   |
| $I_{EN(HI)}$                     | EN pin current (enabled)                                                                                                         | $V_{EN} = 5.5\text{ V}$                                                                                          |                                                                                                                                                                                      | 20                  |                | nA                  |   |   |
| $T_{sd}$                         | Thermal shutdown temperature                                                                                                     | Shutdown, temperature increasing                                                                                 |                                                                                                                                                                                      | 160                 |                | $^\circ\text{C}$    |   |   |
|                                  |                                                                                                                                  | Reset, temperature decreasing                                                                                    |                                                                                                                                                                                      | 140                 |                |                     |   |   |
| $T_J$                            | Operating junction temperature                                                                                                   |                                                                                                                  | -40                                                                                                                                                                                  |                     | 125            | $^\circ\text{C}$    |   |   |

(1) Minimum  $V_{IN} = V_{OUT} + V_{DO}$  or 2.2 V, whichever is greater.

(2) For  $V_{OUT(nom)} < 1.6\text{ V}$ , when  $V_{IN} \leq 1.6\text{ V}$ , the output locks to  $V_{IN}$  and can result in an overvoltage condition on the output. To avoid this situation, disable the device before powering down  $V_{IN}$ .

(3) The TPS73701 is tested at  $V_{OUT} = 1.2\text{ V}$ .

(4) Tolerance of external resistors not included in this specification.

(5)  $V_{DO}$  is not measured for fixed output versions with  $V_{OUT(nom)} < 2.3\text{ V}$  because minimum  $V_{IN} = 2.2\text{ V}$ .

(6) Fixed-voltage versions only; see the [Application Information](#) section for more information.

### 5.6 Typical Characteristics

for all voltage versions at  $T_J = 25^\circ\text{C}$ ,  $V_{IN} = V_{OUT(nom)} + 1\text{ V}$ ,  $I_{OUT} = 10\text{ mA}$ ,  $V_{EN} = 2.2\text{ V}$ , and  $C_{OUT} = 2.2\text{ }\mu\text{F}$  (unless otherwise noted)

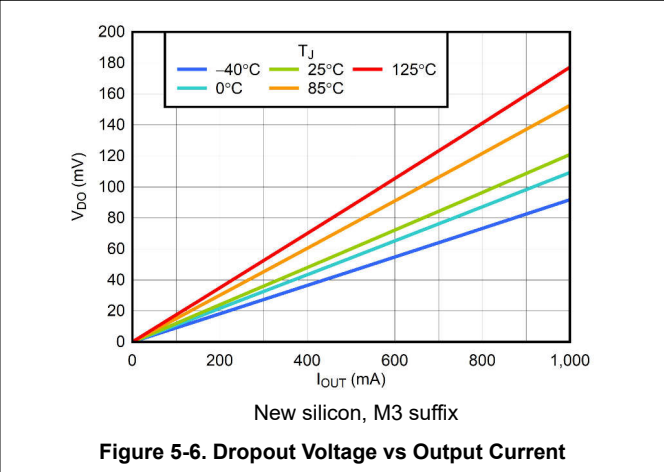
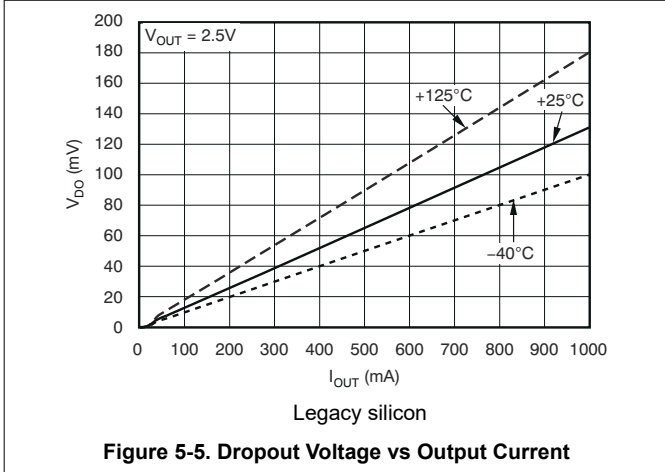
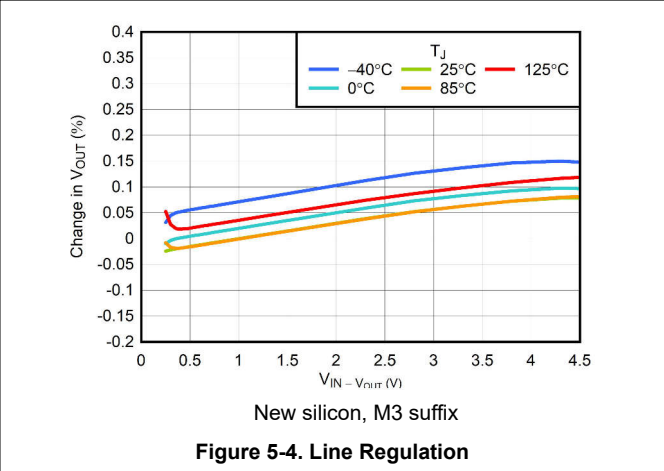
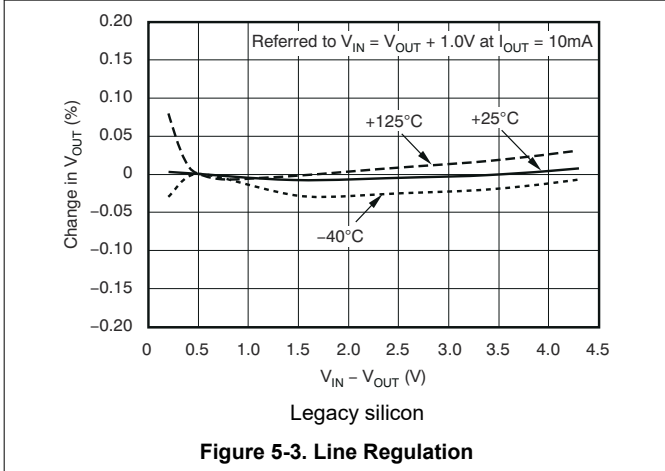
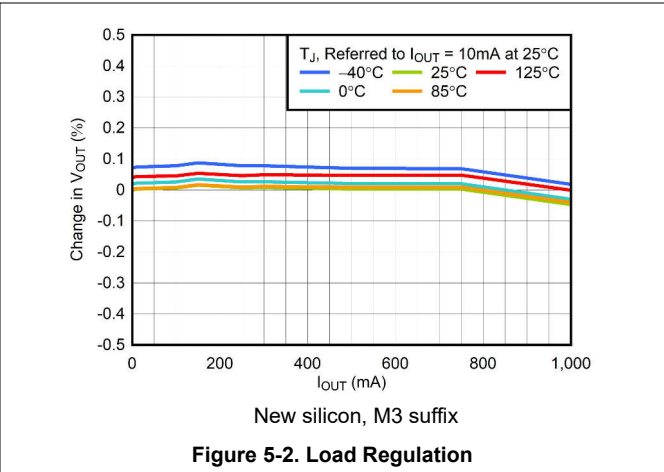
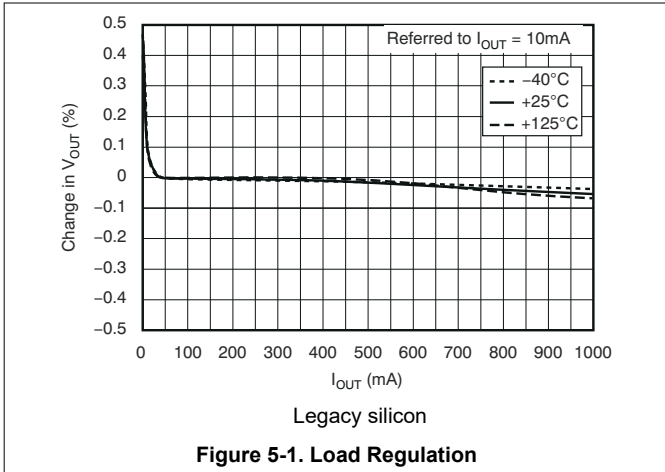

### 5.6 Typical Characteristics (continued)

for all voltage versions at  $T_J = 25^\circ\text{C}$ ,  $V_{IN} = V_{OUT(nom)} + 1\text{ V}$ ,  $I_{OUT} = 10\text{ mA}$ ,  $V_{EN} = 2.2\text{ V}$ , and  $C_{OUT} = 2.2\text{ }\mu\text{F}$  (unless otherwise noted)

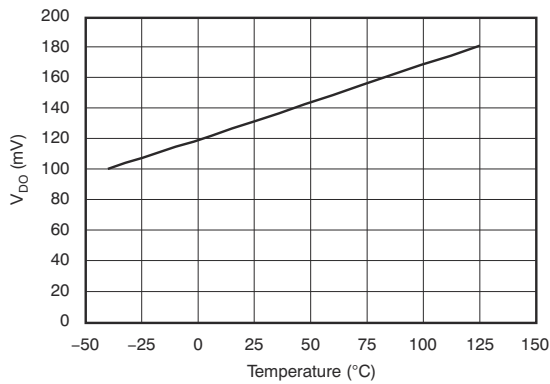

Legacy silicon  
**Figure 5-7. Dropout Voltage vs Temperature**

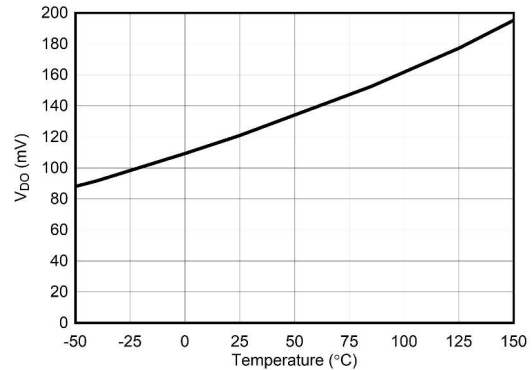

New silicon, M3 suffix  
**Figure 5-8. Dropout Voltage vs Temperature**

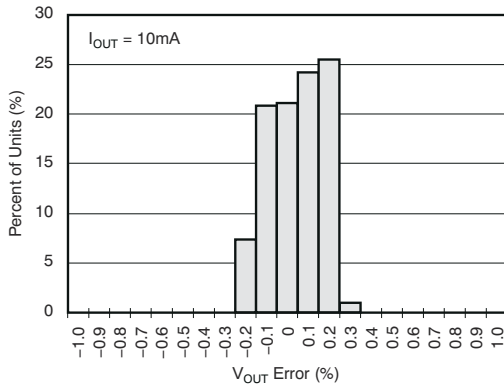

Legacy silicon  
**Figure 5-9. Output Voltage Histogram**

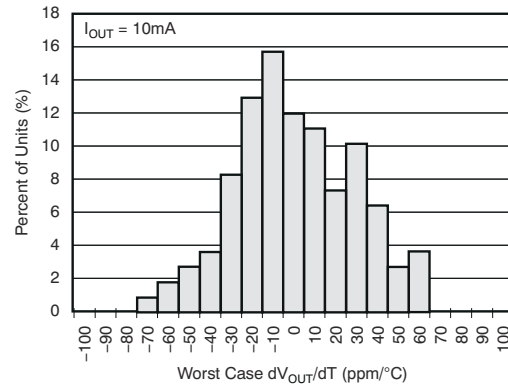

Legacy silicon  
**Figure 5-10. Output Voltage Drift Histogram**

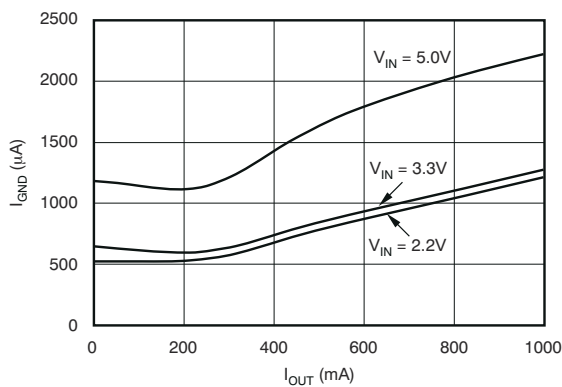

Legacy silicon  
**Figure 5-11. Ground Pin Current vs Output Current**

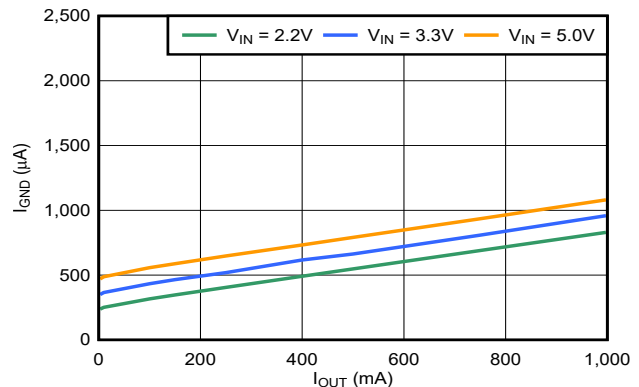

New silicon, M3 suffix  
**Figure 5-12. Ground Pin Current vs Output Current**



### 5.6 Typical Characteristics (continued)

for all voltage versions at  $T_J = 25^\circ\text{C}$ ,  $V_{IN} = V_{OUT(nom)} + 1\text{ V}$ ,  $I_{OUT} = 10\text{ mA}$ ,  $V_{EN} = 2.2\text{ V}$ , and  $C_{OUT} = 2.2\text{ }\mu\text{F}$  (unless otherwise noted)

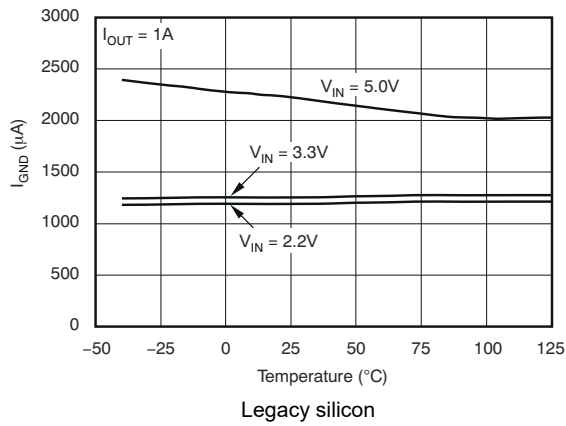

**Figure 5-13. Ground Pin Current vs Temperature**

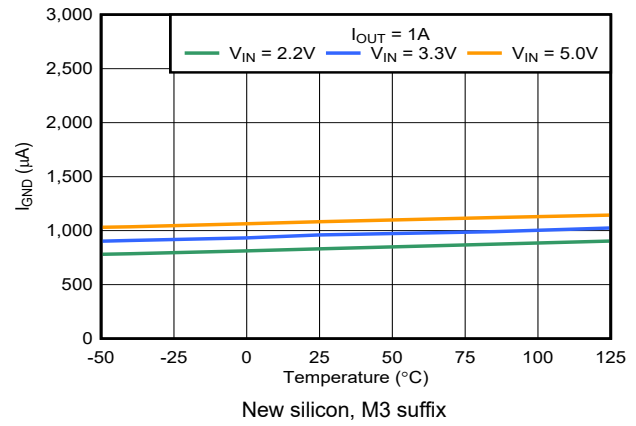

**Figure 5-14. Ground Pin Current vs Temperature**

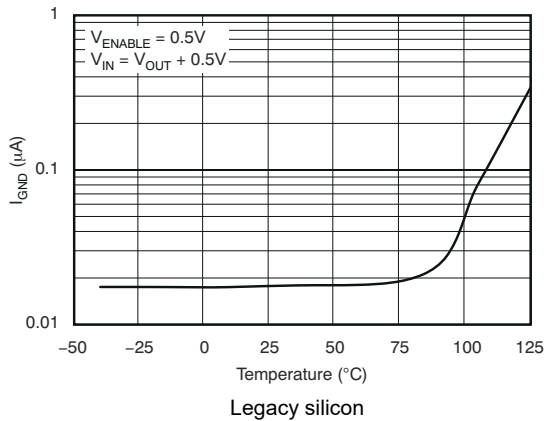

**Figure 5-15. Ground Pin Current in Shutdown vs Temperature**

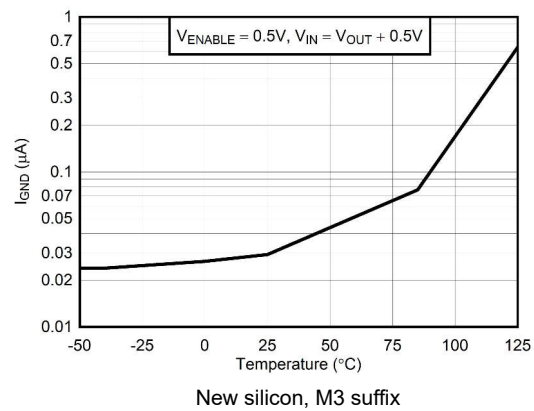

**Figure 5-16. Ground Pin Current in Shutdown vs Temperature**

### 5.6 Typical Characteristics (continued)

for all voltage versions at  $T_J = 25^\circ\text{C}$ ,  $V_{IN} = V_{OUT(nom)} + 1\text{ V}$ ,  $I_{OUT} = 10\text{ mA}$ ,  $V_{EN} = 2.2\text{ V}$ , and  $C_{OUT} = 2.2\text{ }\mu\text{F}$  (unless otherwise noted)

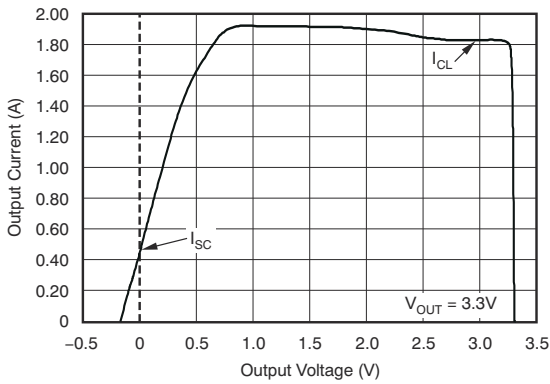

Legacy silicon

Figure 5-17. Current Limit vs  $V_{OUT}$  (Foldback)

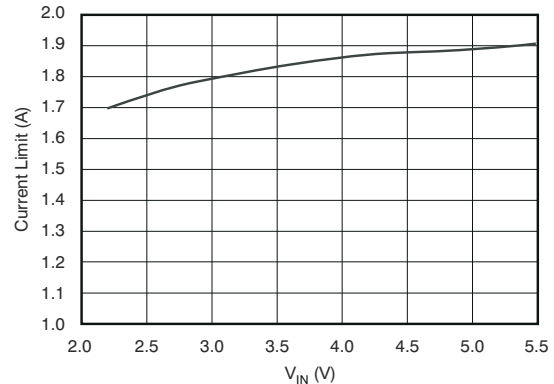

Legacy silicon

Figure 5-18. Current Limit vs  $V_{IN}$

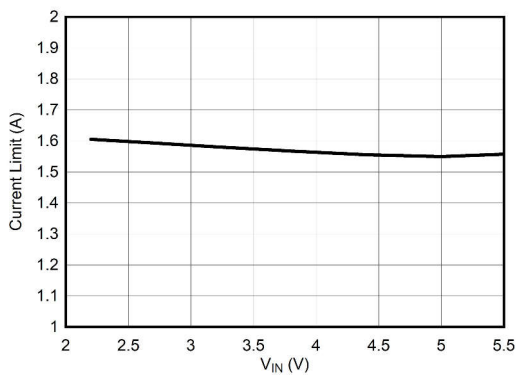

New silicon, M3 suffix

Figure 5-19. Current Limit vs  $V_{IN}$

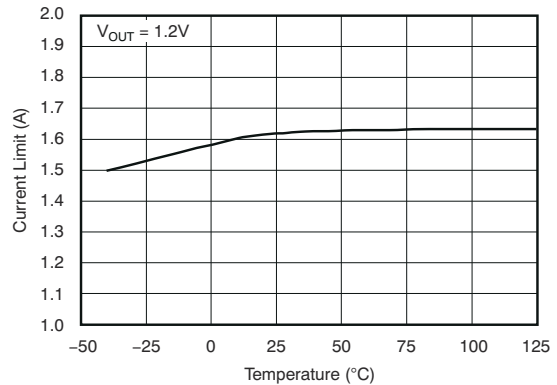

Legacy silicon

Figure 5-20. Current Limit vs Temperature

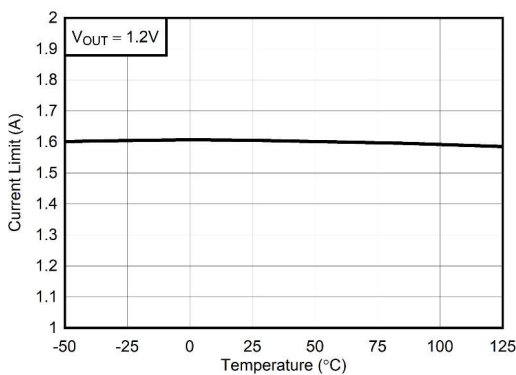

New silicon, M3 suffix

Figure 5-21. Current Limit vs Temperature

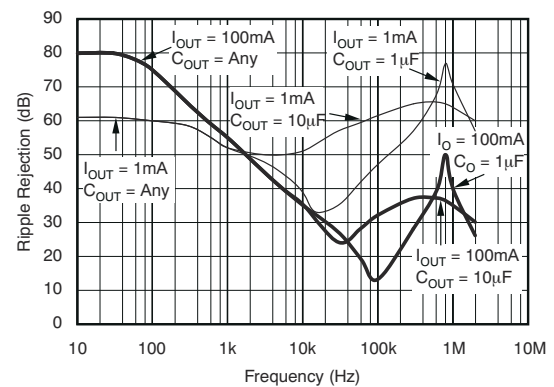

Legacy silicon

Figure 5-22. PSRR (Ripple Rejection) vs Frequency

### 5.6 Typical Characteristics (continued)

for all voltage versions at  $T_J = 25^\circ\text{C}$ ,  $V_{IN} = V_{OUT(nom)} + 1\text{ V}$ ,  $I_{OUT} = 10\text{ mA}$ ,  $V_{EN} = 2.2\text{ V}$ , and  $C_{OUT} = 2.2\text{ }\mu\text{F}$  (unless otherwise noted)

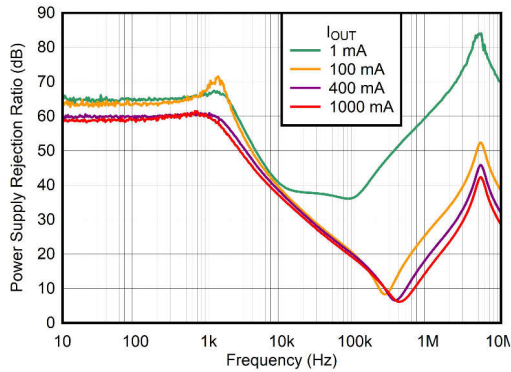

$C_{OUT} = 1\text{ }\mu\text{F}$ , new silicon, M3 suffix

**Figure 5-23. PSRR (Ripple Rejection) vs Frequency**

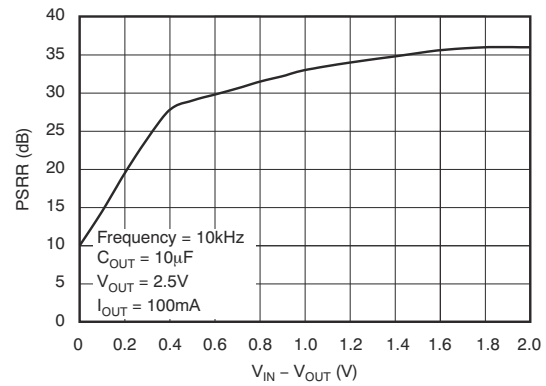

Legacy silicon

**Figure 5-24. PSRR (Ripple Rejection) vs  $(V_{IN} - V_{OUT})$**

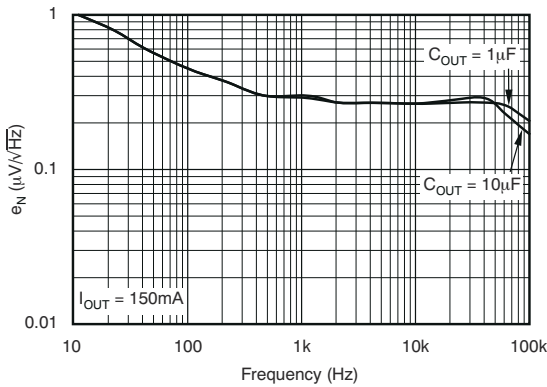

Legacy silicon

**Figure 5-25. Noise Spectral Density**

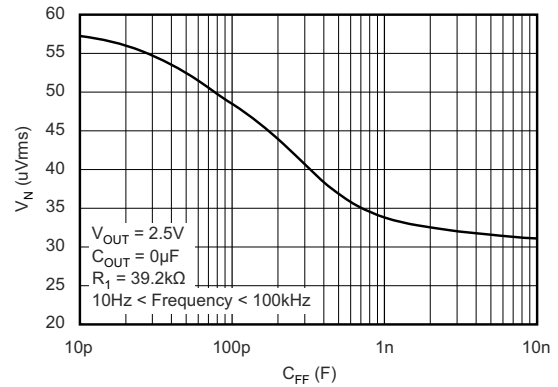

Legacy silicon

**Figure 5-26. TPS73701 RMS Noise Voltage vs  $C_{FB}$**

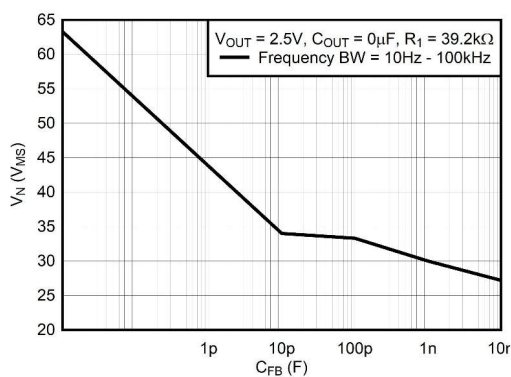

New silicon, M3 suffix

**Figure 5-27. TPS73701 RMS Noise Voltage vs  $C_{FB}$**

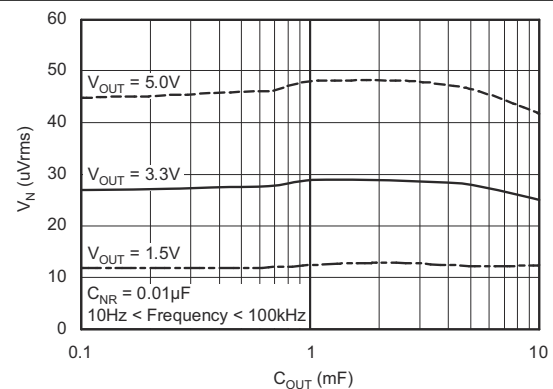

Legacy silicon

**Figure 5-28. RMS Noise Voltage vs  $C_{OUT}$**

### 5.6 Typical Characteristics (continued)

for all voltage versions at  $T_J = 25^\circ\text{C}$ ,  $V_{IN} = V_{OUT(nom)} + 1\text{ V}$ ,  $I_{OUT} = 10\text{ mA}$ ,  $V_{EN} = 2.2\text{ V}$ , and  $C_{OUT} = 2.2\ \mu\text{F}$  (unless otherwise noted)

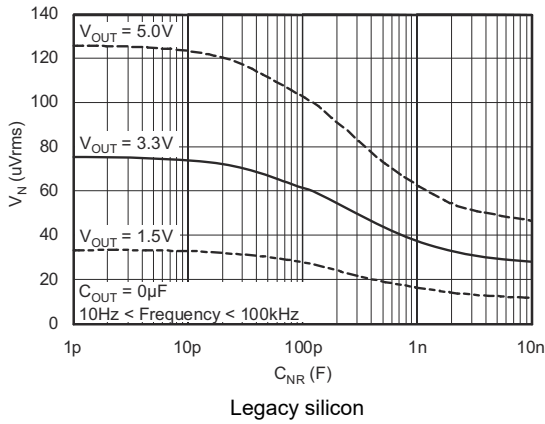

Figure 5-29. RMS Noise Voltage vs  $C_{NR}$

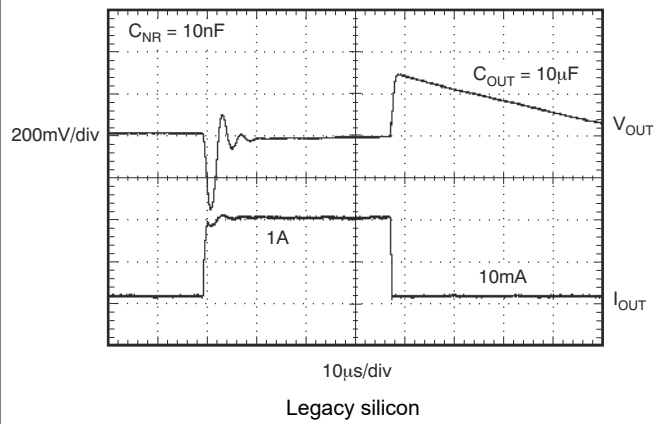

Figure 5-30. TPS73733 Load Transient Response

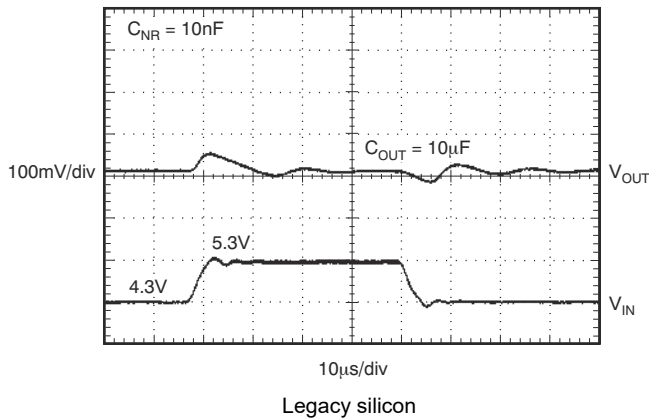

Figure 5-31. TPS73733 Line Transient Response

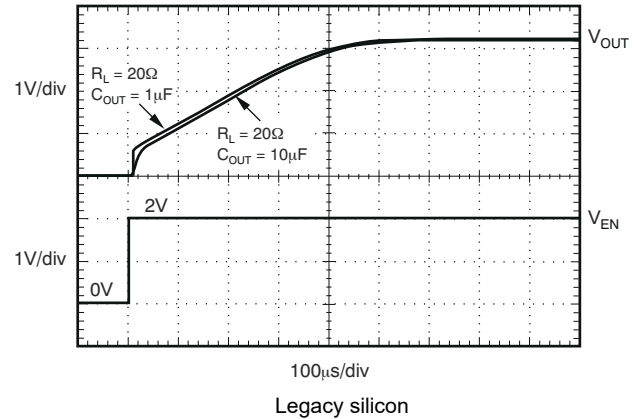

Figure 5-32. TPS73701 Turn-On Response

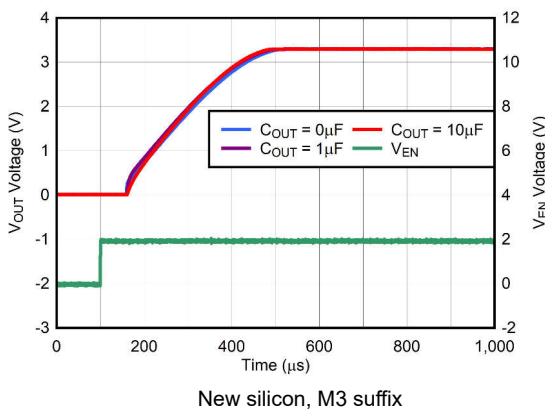

Figure 5-33. TPS73701 Turn-On Response

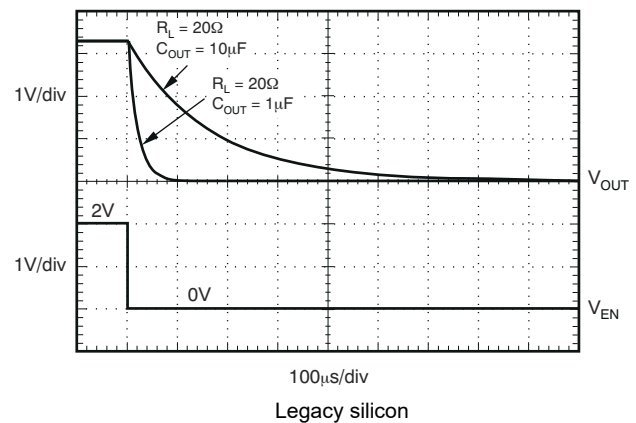

Figure 5-34. TPS73701 Turn-Off Response

### 5.6 Typical Characteristics (continued)

for all voltage versions at  $T_J = 25^\circ\text{C}$ ,  $V_{IN} = V_{OUT(nom)} + 1\text{ V}$ ,  $I_{OUT} = 10\text{ mA}$ ,  $V_{EN} = 2.2\text{ V}$ , and  $C_{OUT} = 2.2\text{ }\mu\text{F}$  (unless otherwise noted)

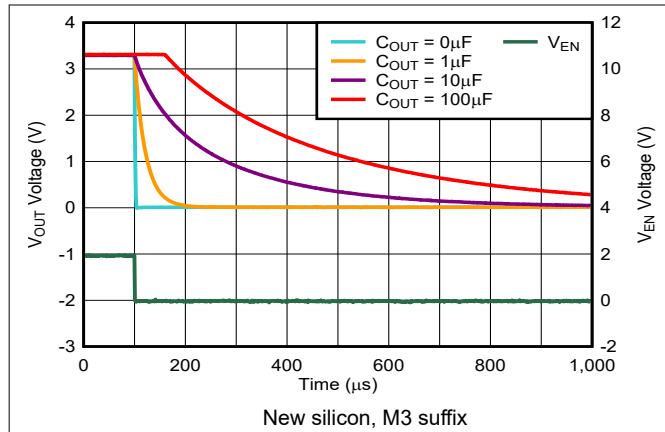

Figure 5-35. TPS73701 Turn-Off Response

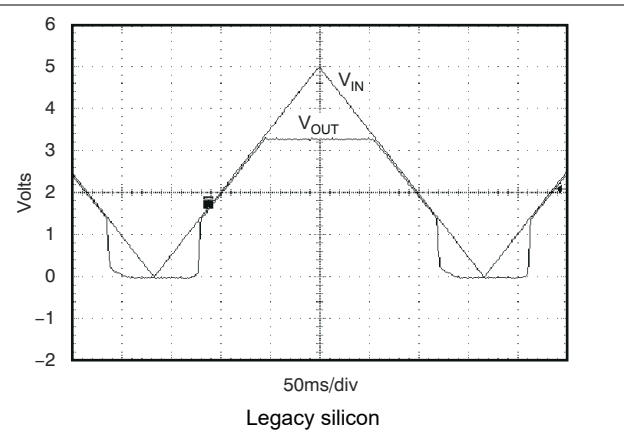

Figure 5-36. TPS73701,  $V_{OUT} = 3.3\text{-V}$  Power-Up and Power-Down

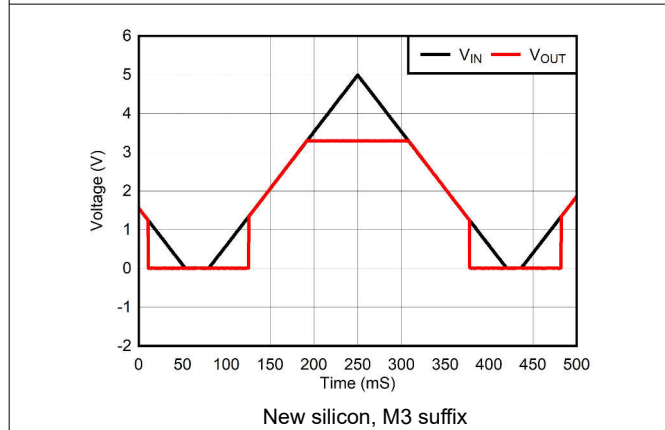

Figure 5-37. TPS73701,  $V_{OUT} = 3.3\text{-V}$  Power-Up and Power-Down

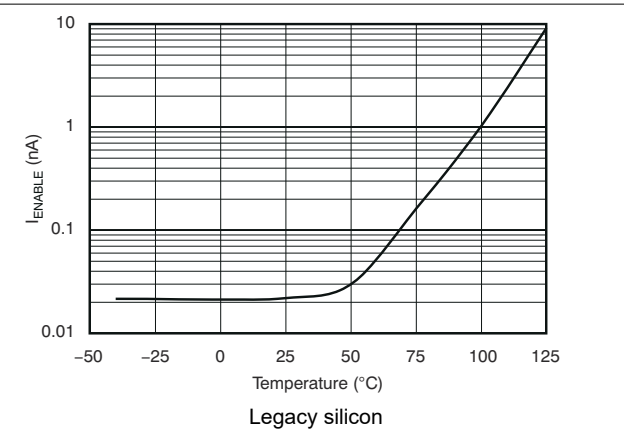

Figure 5-38.  $I_{EN}$  vs Temperature

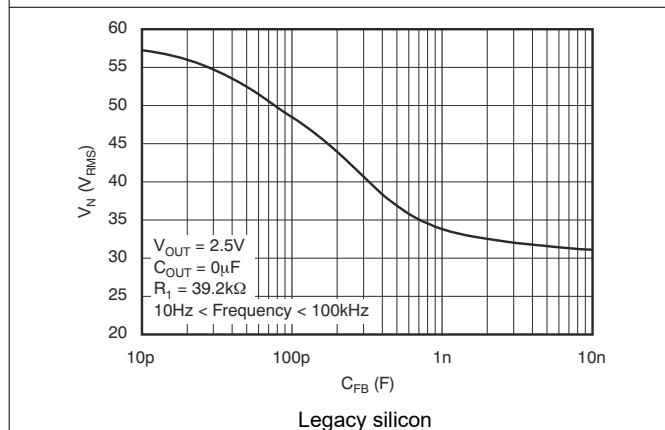

Figure 5-39. TPS73701 RMS Noise Voltage vs  $C_{FB}$

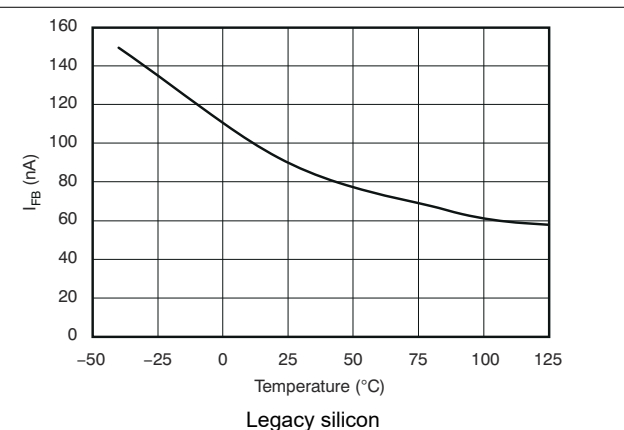

Figure 5-40. TPS73701  $I_{FB}$  vs Temperature

### 5.6 Typical Characteristics (continued)

for all voltage versions at  $T_J = 25^\circ\text{C}$ ,  $V_{IN} = V_{OUT(nom)} + 1\text{ V}$ ,  $I_{OUT} = 10\text{ mA}$ ,  $V_{EN} = 2.2\text{ V}$ , and  $C_{OUT} = 2.2\text{ }\mu\text{F}$  (unless otherwise noted)

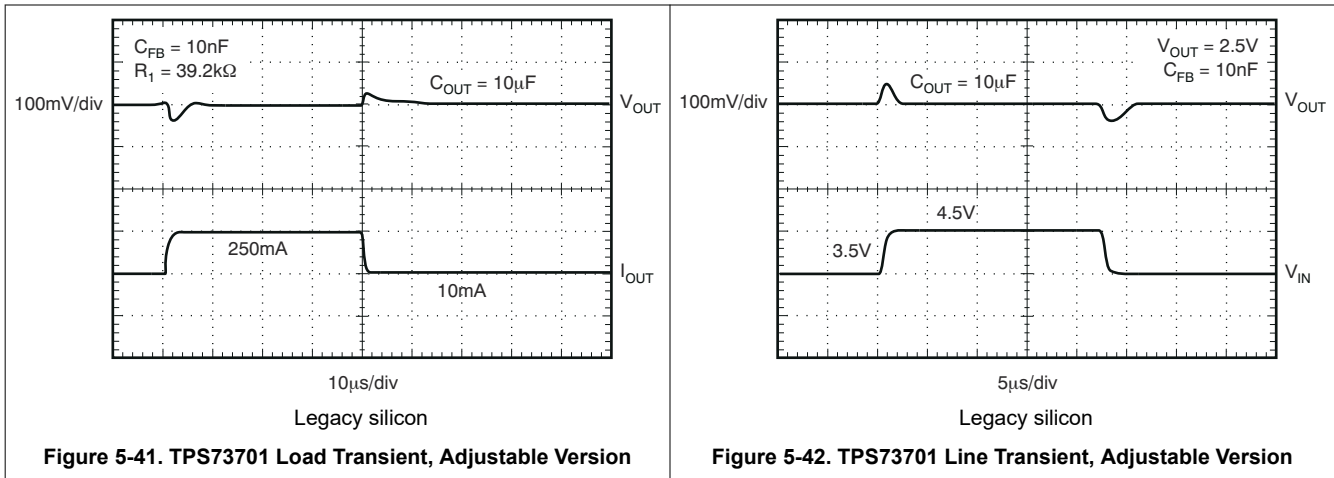

Figure 5-41. TPS73701 Load Transient, Adjustable Version

Figure 5-42. TPS73701 Line Transient, Adjustable Version

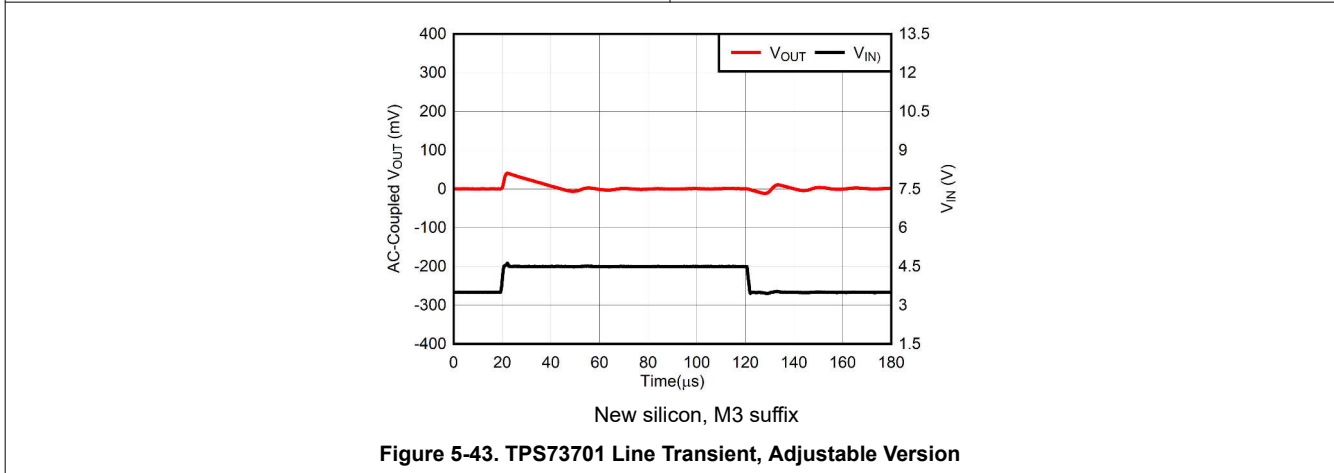

Figure 5-43. TPS73701 Line Transient, Adjustable Version

## 6 Detailed Description

### 6.1 Overview

The TPS737 is a low-dropout (LDO) regulator that uses an n-type field effect (NMOS) pass transistor to achieve ultra-low dropout performance, reverse current blockage, and freedom from output capacitor constraints. These features combined with an enable input make the TPS737 designed for portable applications. This regulator offers a wide selection of fixed-output voltage versions and an adjustable-output version. All versions have thermal and overcurrent protection, including foldback current limit.

### 6.2 Functional Block Diagrams

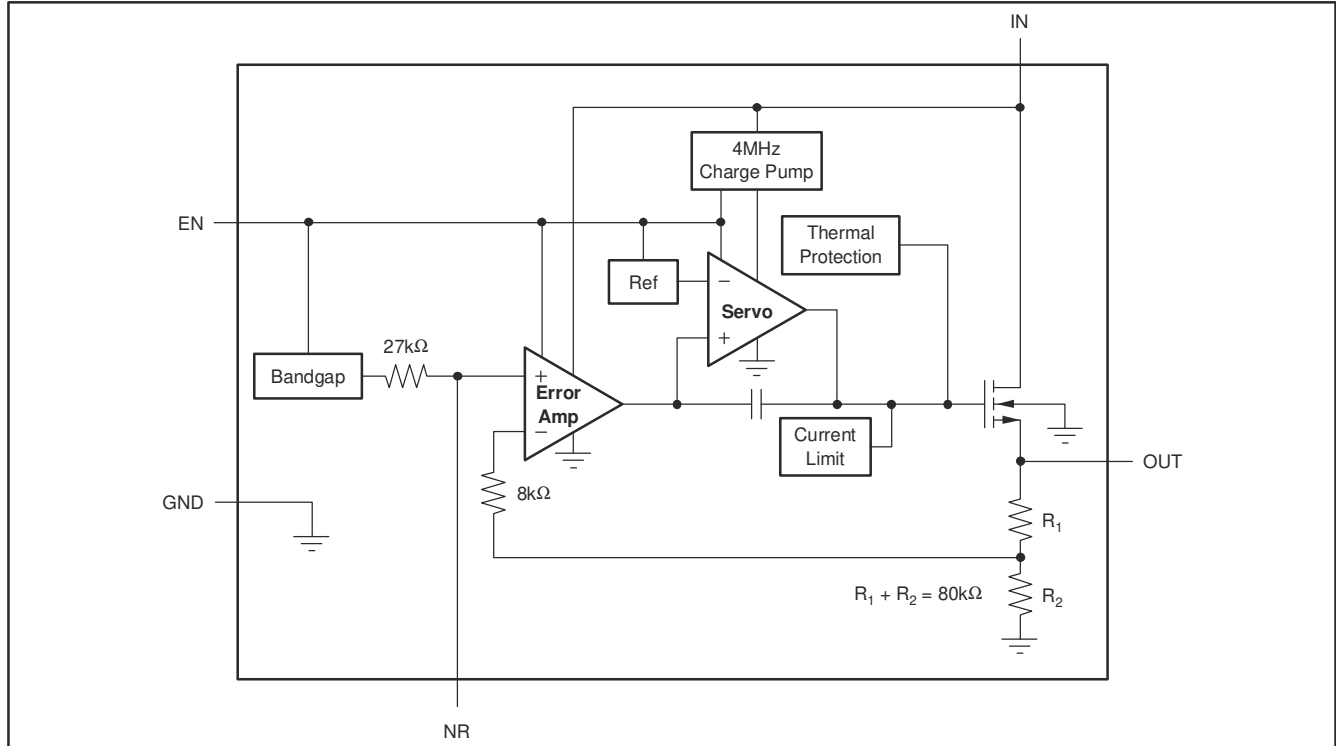
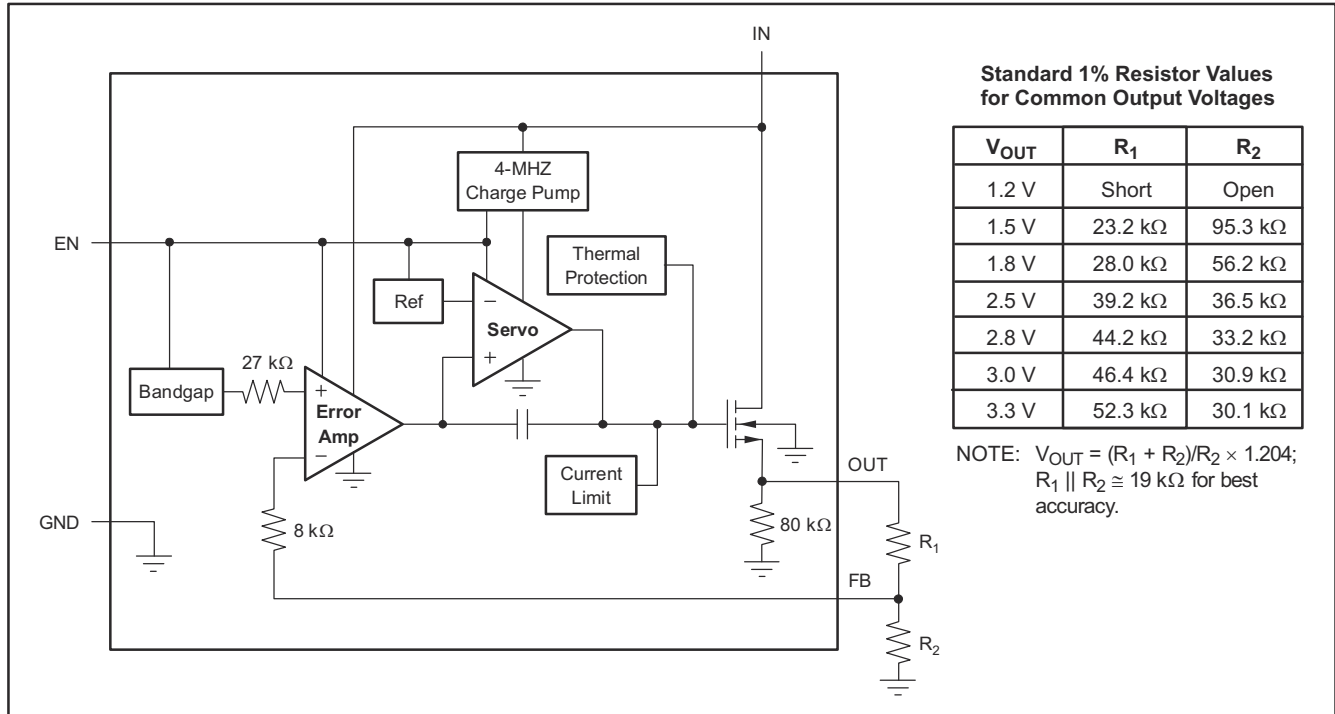

Figure 6-1. Fixed-Voltage Version



**Figure 6-2. Adjustable-Voltage Version**

## 6.3 Feature Description

### 6.3.1 Output Noise

A precision band-gap reference is used to generate the internal reference voltage,  $V_{ref}$ . This reference is the dominant noise source within the TPS737xx and generates approximately  $32 \mu\text{V}_{RMS}$  (10 Hz to 100 kHz) at the reference output (NR). The regulator control loop gains up the reference noise with the same gain as the reference voltage, so that the noise voltage of the regulator is approximately given by:

$$V_N = 32 \mu\text{V}_{RMS} \times \frac{(R_1 + R_2)}{R_2} = 32 \mu\text{V}_{RMS} \times \frac{V_{OUT}}{V_{REF}} \quad (1)$$

Because the value of  $V_R$  is 1.2 V, this relationship reduces to:

$$V_N (\mu\text{V}_{RMS}) = 27 \left( \frac{\mu\text{V}_{RMS}}{\text{V}} \right) \times V_{OUT} (\text{V}) \quad (2)$$

for the case of no  $C_{NR}$ .

An internal 27-kΩ resistor in series with the noise-reduction pin (NR) forms a low-pass filter for the voltage reference when an external noise-reduction capacitor,  $C_{NR}$ , is connected from NR to ground. For  $C_{NR} = 10 \text{ nF}$ , the total noise in the 10-Hz to 100-kHz bandwidth is reduced by a factor of approximately 3.2, giving the approximate relationship:

$$V_N (\mu\text{V}_{RMS}) = 8.5 \left( \frac{\mu\text{V}_{RMS}}{\text{V}} \right) \times V_{OUT} (\text{V}) \quad (3)$$

for  $C_{NR} = 10 \text{ nF}$ .

This noise reduction effect is shown as *RMS Noise Voltage vs  $C_{NR}$*  in the [Typical Characteristics](#) section.



The TPS73701 adjustable version does not have the NR pin available. However, connecting a feedback capacitor,  $C_{FB}$ , from the output to the feedback pin (FB) reduces output noise and improves load transient performance. Limit this capacitor to 0.1  $\mu$ F.

The TPS737 uses an internal charge pump to develop an internal supply voltage sufficient to drive the gate of the NMOS pass transistor above  $V_{OUT}$ . The charge pump generates approximately 250  $\mu$ V of switching noise at approximately 4 MHz; however, charge-pump noise contribution is negligible at the output of the regulator for most values of  $I_{OUT}$  and  $C_{OUT}$ .

### 6.3.2 Internal Current Limit

The TPS737 internal current limit helps protect the regulator during fault conditions. Foldback current limit helps protect the regulator from damage during output short-circuit conditions by reducing current limit when  $V_{OUT}$  drops below 0.5 V. See [Figure 5-17](#) in the *Typical Characteristics* section.

From [Figure 5-17](#), approximately  $-0.2$  V of  $V_{OUT}$  results in a current-limit of 0 mA. Therefore, if OUT is forced below  $-0.2$  V before EN goes high, the device can possibly not start up. In applications that work with both a positive and negative voltage supply, the TPS737 must be enabled first.

### 6.3.3 Enable Pin and Shutdown

The enable pin (EN) is active high and compatible with standard TTL-CMOS levels.  $V_{EN}$  below 0.5 V (maximum) turns the regulator off and drops the GND pin current to approximately 10 nA. When EN is used to shutdown the regulator, all charge is removed from the pass transistor gate, and the output ramps back up to a regulated  $V_{OUT}$  (see [Figure 5-32](#)).

When shutdown capability is not required, EN can be connected to  $V_{IN}$ . However, the pass transistor can possibly not be discharged using this configuration, and the pass transistor can be left on (enhanced) for a significant time after  $V_{IN}$  is removed. This scenario can result in reverse current flow (if the IN pin is low impedance) and faster ramp times upon power up. In addition, for  $V_{IN}$  ramp times slower than a few milliseconds, the output can overshoot upon power up.

Current limit foldback can prevent device start-up under some conditions. See the *Internal Current Limit* section for more information.

### 6.3.4 Reverse Current

The NMOS pass transistor of the TPS737 provides inherent protection against current flow from the output of the regulator to the input when the gate of the pass transistor is pulled low. To make sure that all charge is removed from the gate of the pass transistor, the EN pin must be driven low before the input voltage is removed. If the EN pin is not driven low, the pass transistor can be left on because of stored charge on the gate.

After the EN pin is driven low, no bias voltage is needed on any pin for reverse current blocking. Reverse current is specified as the current flowing out of the IN pin because of voltage applied on the OUT pin. There is additional current flowing into the OUT pin as a result of the 80-k $\Omega$  internal resistor divider to ground (see [Figure 6-1](#) and [Figure 6-2](#)).

For the TPS73701, reverse current can flow when  $V_{FB}$  is more than 1.0 V above  $V_{IN}$ .

## 6.4 Device Functional Modes

Driving the EN pin over 1.7 V turns on the regulator. Driving the EN pin below 0.5 V causes the regulator to enter shutdown mode. In shutdown, the current consumption of the device is reduced to 20 nA, typically.

## 7 Application and Implementation

### Note

Information in the following applications sections is not part of the TI component specification, and TI does not warrant its accuracy or completeness. TI's customers are responsible for determining suitability of components for their purposes, as well as validating and testing their design implementation to confirm system functionality.

### 7.1 Application Information

The TPS737 low-dropout (LDO) regulator uses an NMOS pass transistor to achieve ultra-low-dropout performance, reverse current blockage, and freedom from output capacitor constraints. These features, combined with low noise and an enable input, make the TPS737 designed for portable applications. This regulator offers a wide selection of fixed-output voltage versions and an adjustable-output version. All versions have thermal and overcurrent protection, including foldback current-limit.

### 7.2 Typical Application

Figure 7-1 shows the basic circuit connections for the fixed-voltage models. Figure 7-2 gives the connections for the adjustable output version (TPS73701).

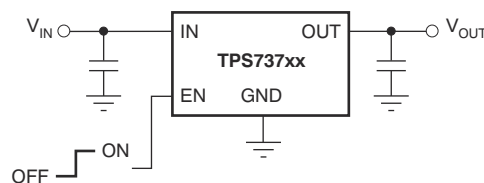

Figure 7-1. Typical Application Circuit for Fixed-Voltage Versions

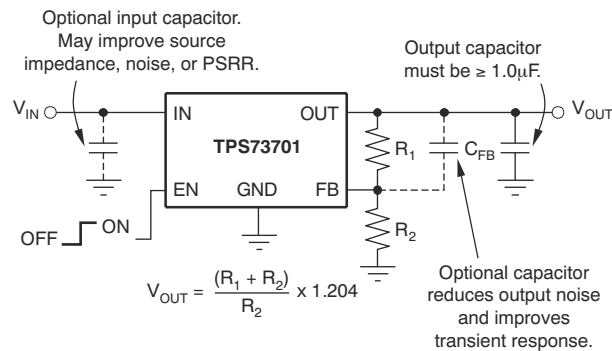

Figure 7-2. Typical Application Circuit for Adjustable-Voltage Version

#### 7.2.1 Design Requirements

$R_1$  and  $R_2$  can be calculated for any output voltage using the formula shown in Figure 7-2. Sample resistor values for common output voltages are given in Figure 6-2.

For best accuracy, make the parallel combination of  $R_1$  and  $R_2$  approximately equal to 19 k $\Omega$ . This 19 k $\Omega$ , in addition to the internal 8-k $\Omega$  resistor, presents the same impedance to the error amp as the 27-k $\Omega$  band-gap reference output. This impedance helps compensate for leakages into the error amplifier terminals.

#### 7.2.2 Detailed Design Procedure

Provide an input supply with adequate headroom to account for dropout and output current to compensate for the GND pin current and to power the load. Further, select adequate input and output capacitors as discussed in the [Input and Output Capacitor Requirements](#) section.

### 7.2.2.1 Input and Output Capacitor Requirements

Although an input capacitor is not required for stability if input impedance is very low, good analog design practice is to connect a 0.1- $\mu\text{F}$  to 1- $\mu\text{F}$  low equivalent series resistance (ESR) capacitor across the input supply near the regulator. This capacitor counteracts reactive input sources and improves transient response, noise rejection, and ripple rejection. A higher-value capacitor can be necessary if large, fast rise-time load transients are anticipated or the device is located several inches from the power source.

The TPS737 requires a 1- $\mu\text{F}$  output capacitor for stability. The device is designed to be stable for all available types and values of capacitors. In applications where multiple low-ESR capacitors are in parallel, ringing can occur when the product of  $C_{\text{OUT}}$  and total ESR drops below 50 nF. Total ESR includes all parasitic resistances, including capacitor ESR and board, socket, and solder joint resistance. In most applications, the sum of capacitor ESR and trace resistance meets this requirement.

### 7.2.2.2 Dropout Voltage

The TPS737 uses an NMOS pass transistor to achieve extremely low dropout. When  $(V_{\text{IN}} - V_{\text{OUT}})$  is less than the dropout voltage ( $V_{\text{DO}}$ ), the NMOS pass transistor is in the linear region of operation and the input-to-output resistance is the  $R_{\text{DS(on)}}$  of the NMOS pass transistor.

For large step changes in load current, the TPS737 requires a larger voltage drop from  $V_{\text{IN}}$  to  $V_{\text{OUT}}$  to avoid degraded transient response. The boundary of this transient dropout region is approximately twice the DC dropout. Values of  $(V_{\text{IN}} - V_{\text{OUT}})$  above this line ensure normal transient response.

Operating in the transient dropout region can cause an increase in recovery time. The time required to recover from a load transient is a function of the magnitude of the change in load current rate, the rate of change in load current, and the available headroom ( $V_{\text{IN-to-}V_{\text{OUT}}}$  voltage drop). Under worst-case conditions [full-scale instantaneous load change with  $(V_{\text{IN}} - V_{\text{OUT}})$  close to DC dropout levels], the TPS737 can take a couple of hundred microseconds to return to the specified regulation accuracy.

### 7.2.2.3 Transient Response

The low open-loop output impedance provided by the NMOS pass transistor in a voltage-follower configuration allows operation without a 1- $\mu\text{F}$  output capacitor. As with any regulator, the addition of additional capacitance from the OUT pin to ground reduces undershoot magnitude but increases undershoot duration. In the adjustable version, the addition of a capacitor,  $C_{\text{FB}}$ , from the OUT pin to the FB pin also improves the transient response.

The TPS737 does not have an active pulldown when the output is overvoltage. This architecture allows applications that connect higher voltage sources, such as alternate power supplies, to the output. This architecture also results in an output overshoot of several percent if the load current quickly drops to zero when a capacitor is connected to the output. The duration of overshoot can be reduced by adding a load resistor. The overshoot decays at a rate determined by output capacitor  $C_{\text{OUT}}$  and the internal and external load resistance. The rate of decay is given by:

(Fixed voltage version)

$$\frac{dV}{dT} = \frac{V_{\text{OUT}}}{C_{\text{OUT}} \times 80\text{k}\Omega \parallel R_{\text{LOAD}}} \quad (4)$$

(Adjustable voltage version)

$$\frac{dV}{dT} = \frac{V_{\text{OUT}}}{C_{\text{OUT}} \times 80\text{k}\Omega \parallel (R_1 + R_2) \parallel R_{\text{LOAD}}} \quad (5)$$

### 7.2.3 Application Curves

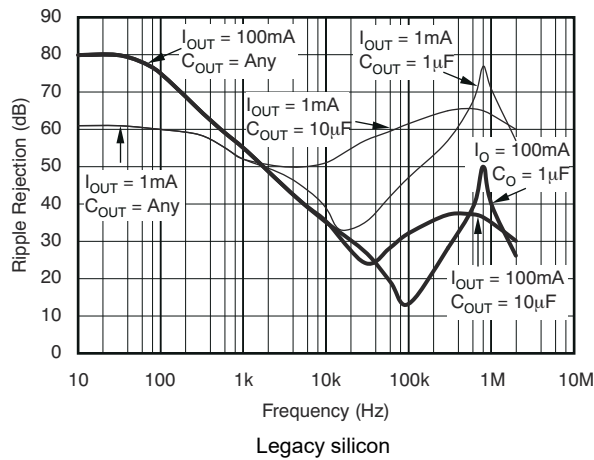

Figure 7-3. PSRR (Ripple Rejection) vs Frequency

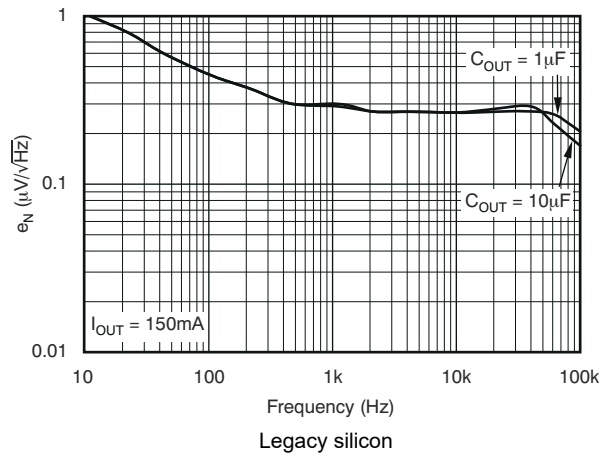

Figure 7-4. Noise Spectral Density

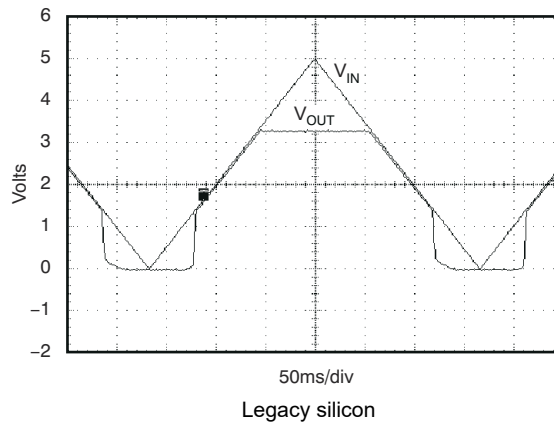

Figure 7-5. TPS73701,  $V_{OUT} = 3.3\text{-V}$  Power-Up and Power-Down

### 7.3 Best Design Practices

Place at least one 1- $\mu\text{F}$  ceramic capacitor as close as possible to the OUT pin of the regulator.

Do not place the output capacitor more than 10-mm away from the regulator.

Connect a 1- $\mu\text{F}$  low equivalent series resistance (ESR) capacitor across the IN pin and GND input of the regulator for improved transient performance.

Do not exceed the absolute maximum ratings.

### 7.4 Power Supply Recommendations

The device is designed to operate from an input voltage supply range between 2.2 V and 5.5 V. The input voltage range provides adequate headroom in order for the device to have a regulated output. This input supply must be well regulated. If the input supply is noisy, additional input capacitors with low ESR help improve the output noise performance.

### 7.5 Layout

#### 7.5.1 Layout Guidelines

To improve AC performance such as PSRR, output noise, and transient response, design the printed-circuit-board (PCB) with separate ground planes for  $V_{IN}$  and  $V_{OUT}$ , with each ground plane connected only at the GND

pin of the device. In addition, the ground connection for the bypass capacitor must connect directly to the GND pin of the device.

### 7.5.1.1 Power Dissipation

Knowing the device power dissipation and proper sizing of the thermal plane that is connected to the tab or pad is critical to avoiding thermal shutdown and to provide reliable operation.

Power dissipation of the device depends on input voltage and load conditions and can be calculated using Equation 6:

$$P_D = (V_{IN} - V_{OUT}) \times I_{OUT} \tag{6}$$

Power dissipation can be minimized and greater efficiency can be achieved by using the lowest possible input voltage necessary to achieve the required output voltage regulation.

On both the VSON (DRB) and WSON (DRV) packages, the primary conduction path for heat is through the exposed pad to the printed circuit board (PCB). The pad can be connected to ground or left floating; however, the pad must be attached to an appropriate amount of copper PCB area to make sure the device does not overheat. On the SOT-223 (DCQ) package, the primary conduction path for heat is through the tab to the PCB. That tab must be connected to ground. The maximum junction-to-ambient thermal resistance depends on the maximum ambient temperature, maximum device junction temperature, and power dissipation of the device and can be calculated using Equation 7:

$$R_{\theta JA} = \frac{(+125^{\circ}\text{C} - T_A)}{P_D} \tag{7}$$

Knowing the maximum  $R_{\theta JA}$ , the minimum amount of PCB copper area needed for appropriate heat sinking can be estimated using Figure 7-6.

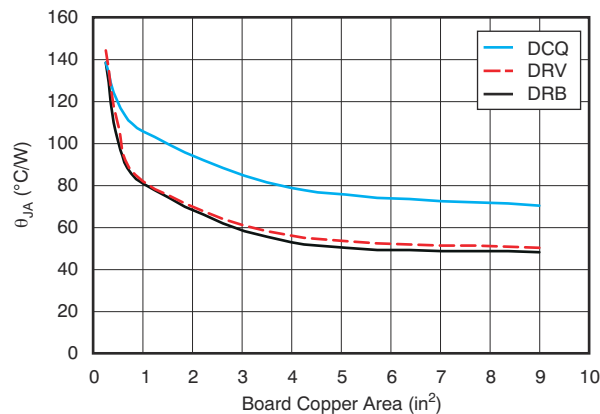

$R_{\theta JA}$  value at board size of 9 in<sup>2</sup> (that is, 3 in × 3 in) is a JEDEC standard.

**Figure 7-6.  $R_{\theta JA}$  vs Board Size**

Figure 7-6 shows the variation of  $R_{\theta JA}$  as a function of ground plane copper area in the board. Figure 7-6 is intended only as a guideline to demonstrate the effects of heat spreading in the ground plane and is not intended to be used to estimate actual thermal performance in real application environments.

**Note**

When the device is mounted on an application PCB, use  $\Psi_{JT}$  and  $\Psi_{JB}$ , as explained in the *Thermal Information* table.

### 7.5.1.2 Thermal Protection

Thermal protection disables the output when the junction temperature rises to approximately 160°C, allowing the device to cool. When the junction temperature cools to approximately 140°C, the output circuitry is again enabled. Depending on power dissipation, thermal resistance, and ambient temperature, the thermal protection circuit can cycle on and off. This cycling limits the dissipation of the regulator, protecting the regulator from damage caused by overheating.

Any tendency to activate the thermal protection circuit indicates excessive power dissipation or an inadequate heat sink. For reliable operation, limit junction temperature to 125°C maximum. To estimate the margin of safety in a complete design (including heat sink), increase the ambient temperature until the thermal protection is triggered; use worst-case loads and signal conditions. For good reliability, thermal protection must trigger at least 35°C above the maximum expected ambient condition of the application. This buffer produces a worst-case junction temperature of 125°C at the highest expected ambient temperature and worst-case load.

The internal protection circuitry of the TPS737 is designed to protect against overload conditions. This circuitry is not intended to replace proper heat sinking. Continuously running the TPS737 into thermal shutdown degrades device reliability.

### 7.5.1.3 Estimating Junction Temperature

Using the thermal metrics  $\Psi_{JT}$  and  $\Psi_{JB}$ , as shown in the *Thermal Information* table, the junction temperature can be estimated with corresponding formulas (given in Equation 8). For backward compatibility, an older  $\theta_{JC, Top}$  parameter is listed as well.

$$\begin{aligned}\Psi_{JT}: T_J &= T_T + \Psi_{JT} \cdot P_D \\ \Psi_{JB}: T_J &= T_B + \Psi_{JB} \cdot P_D\end{aligned}\tag{8}$$

where:

- $P_D$  is the power dissipation shown by Equation 6
- $T_T$  is the temperature at the center-top of the device package
- $T_B$  is the PCB temperature measured 1-mm away from the device package *on the PCB surface* (as Figure 7-8 shows)

---

#### Note

Both  $T_T$  and  $T_B$  can be measured on actual application boards using a thermo-gun (an infrared thermometer).

---

For more information about measuring  $T_T$  and  $T_B$ , see the *Using New Thermal Metrics application note*, available for download at [www.ti.com](http://www.ti.com).

As Figure 7-7 shows, the new thermal metrics ( $\Psi_{JT}$  and  $\Psi_{JB}$ ) have very little dependency on board size. That is, using  $\Psi_{JT}$  or  $\Psi_{JB}$  with Equation 8 is a good way to estimate  $T_J$  by simply measuring  $T_T$  or  $T_B$ , regardless of the application board size.

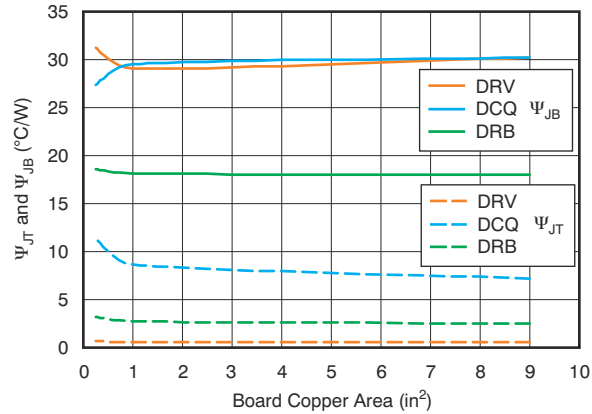

Figure 7-7.  $\Psi_{JT}$  and  $\Psi_{JB}$  vs Board Size

For a more detailed discussion of why TI does not recommend using  $\theta_{JC(top)}$  to determine thermal characteristics, see the [Using New Thermal Metrics application note](#), available for download at [www.ti.com](http://www.ti.com). For further information, see the [Semiconductor and IC Package Thermal Metrics application note](#), also available on the TI website. Figure 7-8 shows the measuring points for DRB, DRV, and DCQ packages.

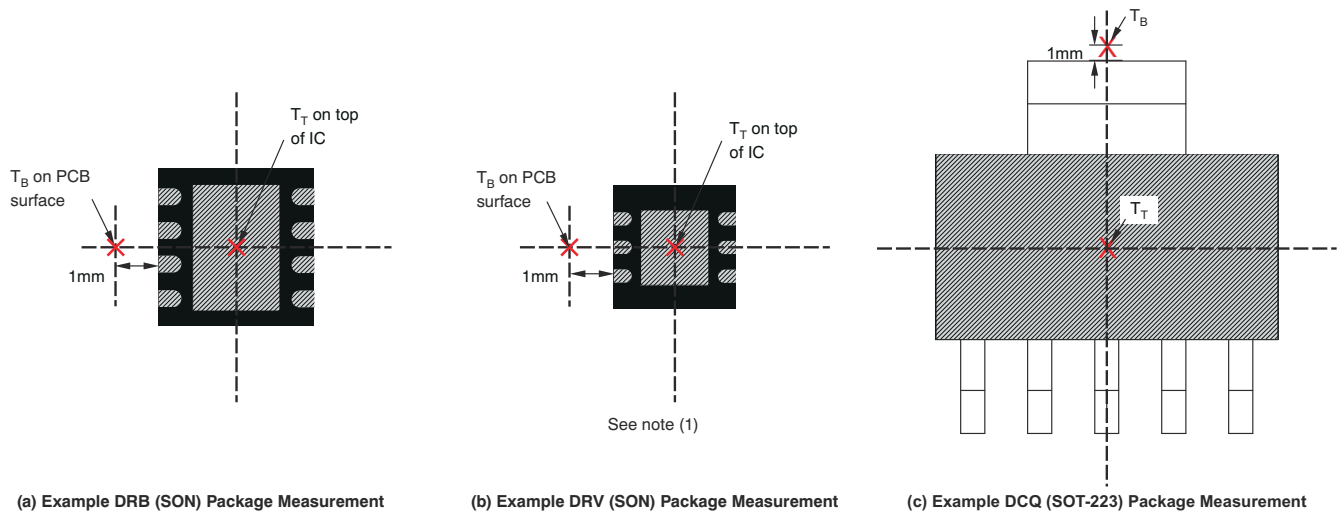
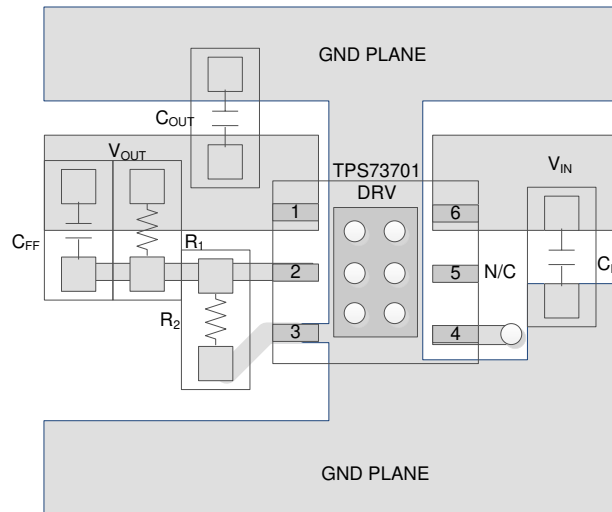

Figure 7-8. Measuring Points for  $T_T$  and  $T_B$

A. Power dissipation can limit operating range. Check the *Thermal Information* table.

### 7.5.2 Layout Example



**Figure 7-9. Layout Example**



## 8 Device and Documentation Support

### 8.1 Device Support

#### 8.1.1 Development Support

##### 8.1.1.1 Evaluation Modules

An evaluation module (EVM) is available to assist in the initial circuit performance evaluation using the TPS737. The [TPS73701DRVEVM-529 evaluation module](#) (and related [user's guide](#)) can be requested at the Texas Instruments website through the product folders or purchased directly from the [TI eStore](#).

##### 8.1.1.2 Spice Models

Computer simulation of circuit performance using SPICE is often useful when analyzing the performance of analog circuits and systems. A SPICE model for the TPS737 is available through the product folders under *Tools & Software*.

#### 8.1.2 Device Nomenclature

**Table 8-1. Ordering Information<sup>(1)</sup>**

| PRODUCT          | V <sub>OUT</sub> <sup>(1)</sup>                                                                                                                                                                                                                                                                                                                                                                                                                                                                                                                                                                            |
|------------------|------------------------------------------------------------------------------------------------------------------------------------------------------------------------------------------------------------------------------------------------------------------------------------------------------------------------------------------------------------------------------------------------------------------------------------------------------------------------------------------------------------------------------------------------------------------------------------------------------------|
| TPS737xxyyyz(M3) | <p><b>xx</b> is the nominal output voltage (for example, 25 = 2.5 V, 01 = Adjustable<sup>(2)</sup>).</p> <p><b>yyy</b> is the package designator.</p> <p><b>z</b> is the package quantity.</p> <p><b>M3</b> is a suffix designator for devices that only use the latest manufacturing flow (CSO: RFB). Devices without this suffix can ship with the <i>legacy silicon</i> (CSO: DLN) or the <i>new silicon</i> (CSO: RFB). The reel packaging label provides CSO information to distinguish which chip is being used. Device performance for new and legacy chips is denoted throughout the document.</p> |

- (1) For the most current package and ordering information see the Package Option Addendum at the end of this document, or see the device product folder at [www.ti.com](#).  
 (2) For fixed 1.20-V operation, tie FB to OUT.

### 8.2 Documentation Support

#### 8.2.1 Related Documentation

For related documentation see the following:

- Texas Instruments, [Using New Thermal Metrics application note](#)
- Texas Instruments, [TPS73701DRVEVM-529 User's Guide user guide](#)
- Texas Instruments, [TMS320DM644x Power Reference Design application note](#)
- Texas Instruments, [TPS73x01DRBEVM-518 User's Guide user guide](#)

#### 8.3 Receiving Notification of Documentation Updates

To receive notification of documentation updates, navigate to the device product folder on [ti.com](#). Click on *Notifications* to register and receive a weekly digest of any product information that has changed. For change details, review the revision history included in any revised document.

#### 8.4 Support Resources

[TI E2E™ support forums](#) are an engineer's go-to source for fast, verified answers and design help — straight from the experts. Search existing answers or ask your own question to get the quick design help you need.

Linked content is provided "AS IS" by the respective contributors. They do not constitute TI specifications and do not necessarily reflect TI's views; see TI's [Terms of Use](#).

#### 8.5 Trademarks

TI E2E™ is a trademark of Texas Instruments.  
 All trademarks are the property of their respective owners.

## 8.6 Electrostatic Discharge Caution



This integrated circuit can be damaged by ESD. Texas Instruments recommends that all integrated circuits be handled with appropriate precautions. Failure to observe proper handling and installation procedures can cause damage.

ESD damage can range from subtle performance degradation to complete device failure. Precision integrated circuits may be more susceptible to damage because very small parametric changes could cause the device not to meet its published specifications.

## 8.7 Glossary

[TI Glossary](#) This glossary lists and explains terms, acronyms, and definitions.

## 9 Revision History

NOTE: Page numbers for previous revisions may differ from page numbers in the current version.

| Changes from Revision S (November 2023) to Revision T (December 2023)                      | Page              |
|--------------------------------------------------------------------------------------------|-------------------|
| • Changed M3 device status from <i>Advance Information</i> to <i>Production Data</i> ..... | <a href="#">1</a> |
| • Added M3 suffix curves to <i>Typical Characteristics</i> section.....                    | <a href="#">7</a> |

| Changes from Revision R (December 2019) to Revision S (November 2023) | Page              |
|-----------------------------------------------------------------------|-------------------|
| • Added M3 devices to document.....                                   | <a href="#">1</a> |
| • Added DRB data to <i>Thermal Information</i> table.....             | <a href="#">5</a> |
| • Changed <i>Electrical Characteristics</i> table.....                | <a href="#">6</a> |

## 10 Mechanical, Packaging, and Orderable Information

The following pages include mechanical, packaging, and orderable information. This information is the most current data available for the designated devices. This data is subject to change without notice and revision of this document. For browser-based versions of this data sheet, refer to the left-hand navigation.

**PACKAGING INFORMATION**

| Orderable Device | Status<br>(1) | Package Type | Package Drawing | Pins | Package Qty | Eco Plan<br>(2) | Lead finish/<br>Ball material<br>(6) | MSL Peak Temp<br>(3) | Op Temp (°C) | Device Marking<br>(4/5) | Samples                 |
|------------------|---------------|--------------|-----------------|------|-------------|-----------------|--------------------------------------|----------------------|--------------|-------------------------|-------------------------|
| PS73701DRBRM3    | ACTIVE        | SON          | DRB             | 8    | 3000        | TBD             | Call TI                              | Call TI              | -40 to 125   |                         | <a href="#">Samples</a> |
| TPS73701DCQ      | ACTIVE        | SOT-223      | DCQ             | 6    | 78          | RoHS & Green    | SN                                   | Level-2-260C-1 YEAR  | -40 to 125   | TPS73701                | <a href="#">Samples</a> |
| TPS73701DCQG4    | ACTIVE        | SOT-223      | DCQ             | 6    | 78          | RoHS & Green    | NIPDAU                               | Level-2-260C-1 YEAR  | -40 to 125   | TPS73701                | <a href="#">Samples</a> |
| TPS73701DCQR     | ACTIVE        | SOT-223      | DCQ             | 6    | 2500        | RoHS & Green    | SN                                   | Level-2-260C-1 YEAR  | -40 to 125   | TPS73701                | <a href="#">Samples</a> |
| TPS73701DCQRG4   | ACTIVE        | SOT-223      | DCQ             | 6    | 2500        | RoHS & Green    | NIPDAU                               | Level-2-260C-1 YEAR  | -40 to 125   | TPS73701                | <a href="#">Samples</a> |
| TPS73701DRBR     | ACTIVE        | SON          | DRB             | 8    | 3000        | RoHS & Green    | NIPDAU                               | Level-2-260C-1 YEAR  | -40 to 125   | BZN                     | <a href="#">Samples</a> |
| TPS73701DRBRG4   | ACTIVE        | SON          | DRB             | 8    | 3000        | RoHS & Green    | NIPDAU                               | Level-2-260C-1 YEAR  | -40 to 125   | BZN                     | <a href="#">Samples</a> |
| TPS73701DRBRM3   | ACTIVE        | SON          | DRB             | 8    | 3000        | RoHS & Green    | NIPDAU                               | Level-1-260C-UNLIM   | -40 to 125   | BZN                     | <a href="#">Samples</a> |
| TPS73701DRBT     | ACTIVE        | SON          | DRB             | 8    | 250         | RoHS & Green    | NIPDAU                               | Level-2-260C-1 YEAR  | -40 to 125   | BZN                     | <a href="#">Samples</a> |
| TPS73701DRVR     | ACTIVE        | WSON         | DRV             | 6    | 3000        | RoHS & Green    | NIPDAU                               | Level-2-260C-1 YEAR  | -40 to 125   | QTN                     | <a href="#">Samples</a> |
| TPS73701DRV      | ACTIVE        | WSON         | DRV             | 6    | 250         | RoHS & Green    | NIPDAU                               | Level-2-260C-1 YEAR  | -40 to 125   | QTN                     | <a href="#">Samples</a> |
| TPS73718DCQ      | ACTIVE        | SOT-223      | DCQ             | 6    | 78          | RoHS & Green    | SN                                   | Level-2-260C-1 YEAR  | -40 to 125   | TPS73718                | <a href="#">Samples</a> |
| TPS73718DCQR     | ACTIVE        | SOT-223      | DCQ             | 6    | 2500        | RoHS & Green    | SN                                   | Level-2-260C-1 YEAR  | -40 to 125   | TPS73718                | <a href="#">Samples</a> |
| TPS73718DCQRG4   | ACTIVE        | SOT-223      | DCQ             | 6    | 2500        | RoHS & Green    | NIPDAU                               | Level-2-260C-1 YEAR  | -40 to 125   | TPS73718                | <a href="#">Samples</a> |
| TPS73718DRBR     | ACTIVE        | SON          | DRB             | 8    | 3000        | RoHS & Green    | NIPDAU                               | Level-2-260C-1 YEAR  | -40 to 125   | RAL                     | <a href="#">Samples</a> |
| TPS73718DRBT     | LIFEBUY       | SON          | DRB             | 8    | 250         | RoHS & Green    | NIPDAU                               | Level-2-260C-1 YEAR  | -40 to 125   | RAL                     |                         |
| TPS73725DCQ      | LIFEBUY       | SOT-223      | DCQ             | 6    | 78          | RoHS & Green    | NIPDAU                               | Level-2-260C-1 YEAR  | -40 to 125   | TPS73725                |                         |
| TPS73725DCQR     | ACTIVE        | SOT-223      | DCQ             | 6    | 2500        | RoHS & Green    | SN                                   | Level-2-260C-1 YEAR  | -40 to 125   | TPS73725                | <a href="#">Samples</a> |
| TPS73730DRBR     | ACTIVE        | SON          | DRB             | 8    | 3000        | RoHS & Green    | NIPDAU                               | Level-2-260C-1 YEAR  | -40 to 125   | CVT                     | <a href="#">Samples</a> |
| TPS73730DRBT     | LIFEBUY       | SON          | DRB             | 8    | 250         | RoHS & Green    | NIPDAU                               | Level-2-260C-1 YEAR  | -40 to 125   | CVT                     |                         |
| TPS73733DCQ      | ACTIVE        | SOT-223      | DCQ             | 6    | 78          | RoHS & Green    | SN                                   | Level-2-260C-1 YEAR  | -40 to 125   | TPS73733                | <a href="#">Samples</a> |

| Orderable Device | Status<br>(1) | Package Type | Package Drawing | Pins | Package Qty | Eco Plan<br>(2) | Lead finish/<br>Ball material<br>(6) | MSL Peak Temp<br>(3) | Op Temp (°C) | Device Marking<br>(4/5) | Samples                 |
|------------------|---------------|--------------|-----------------|------|-------------|-----------------|--------------------------------------|----------------------|--------------|-------------------------|-------------------------|
| TPS73733DCQG4    | ACTIVE        | SOT-223      | DCQ             | 6    | 78          | RoHS & Green    | NIPDAU                               | Level-2-260C-1 YEAR  | -40 to 125   | TPS73733                | <a href="#">Samples</a> |
| TPS73733DCQR     | ACTIVE        | SOT-223      | DCQ             | 6    | 2500        | RoHS & Green    | SN                                   | Level-2-260C-1 YEAR  | -40 to 125   | TPS73733                | <a href="#">Samples</a> |
| TPS73733DCQRG4   | ACTIVE        | SOT-223      | DCQ             | 6    | 2500        | RoHS & Green    | NIPDAU                               | Level-2-260C-1 YEAR  | -40 to 125   | TPS73733                | <a href="#">Samples</a> |
| TPS73733DRVR     | ACTIVE        | WSON         | DRV             | 6    | 3000        | RoHS & Green    | NIPDAU                               | Level-2-260C-1 YEAR  | -40 to 125   | SIJ                     | <a href="#">Samples</a> |
| TPS73733DRVT     | LIFEBUY       | WSON         | DRV             | 6    | 250         | RoHS & Green    | NIPDAU                               | Level-2-260C-1 YEAR  | -40 to 125   | SIJ                     |                         |
| TPS73734DCQ      | ACTIVE        | SOT-223      | DCQ             | 6    | 78          | RoHS & Green    | NIPDAU                               | Level-2-260C-1 YEAR  | -40 to 125   | OCH                     | <a href="#">Samples</a> |
| TPS73734DCQR     | ACTIVE        | SOT-223      | DCQ             | 6    | 2500        | RoHS & Green    | NIPDAU                               | Level-2-260C-1 YEAR  | -40 to 125   | OCH                     | <a href="#">Samples</a> |

(1) The marketing status values are defined as follows:

**ACTIVE:** Product device recommended for new designs.

**LIFEBUY:** TI has announced that the device will be discontinued, and a lifetime-buy period is in effect.

**NRND:** Not recommended for new designs. Device is in production to support existing customers, but TI does not recommend using this part in a new design.

**PREVIEW:** Device has been announced but is not in production. Samples may or may not be available.

**OBSELETE:** TI has discontinued the production of the device.

(2) **RoHS:** TI defines "RoHS" to mean semiconductor products that are compliant with the current EU RoHS requirements for all 10 RoHS substances, including the requirement that RoHS substance do not exceed 0.1% by weight in homogeneous materials. Where designed to be soldered at high temperatures, "RoHS" products are suitable for use in specified lead-free processes. TI may reference these types of products as "Pb-Free".

**RoHS Exempt:** TI defines "RoHS Exempt" to mean products that contain lead but are compliant with EU RoHS pursuant to a specific EU RoHS exemption.

**Green:** TI defines "Green" to mean the content of Chlorine (Cl) and Bromine (Br) based flame retardants meet JS709B low halogen requirements of <=1000ppm threshold. Antimony trioxide based flame retardants must also meet the <=1000ppm threshold requirement.

(3) MSL, Peak Temp. - The Moisture Sensitivity Level rating according to the JEDEC industry standard classifications, and peak solder temperature.

(4) There may be additional marking, which relates to the logo, the lot trace code information, or the environmental category on the device.

(5) Multiple Device Markings will be inside parentheses. Only one Device Marking contained in parentheses and separated by a "~" will appear on a device. If a line is indented then it is a continuation of the previous line and the two combined represent the entire Device Marking for that device.

(6) Lead finish/Ball material - Orderable Devices may have multiple material finish options. Finish options are separated by a vertical ruled line. Lead finish/Ball material values may wrap to two lines if the finish value exceeds the maximum column width.

**Important Information and Disclaimer:**The information provided on this page represents TI's knowledge and belief as of the date that it is provided. TI bases its knowledge and belief on information provided by third parties, and makes no representation or warranty as to the accuracy of such information. Efforts are underway to better integrate information from third parties. TI has taken and continues to take reasonable steps to provide representative and accurate information but may not have conducted destructive testing or chemical analysis on incoming materials and chemicals. TI and TI suppliers consider certain information to be proprietary, and thus CAS numbers and other limited information may not be available for release.

In no event shall TI's liability arising out of such information exceed the total purchase price of the TI part(s) at issue in this document sold by TI to Customer on an annual basis.

**OTHER QUALIFIED VERSIONS OF TPS737 :**

- Automotive : [TPS737-Q1](#)

NOTE: Qualified Version Definitions:

- Automotive - Q100 devices qualified for high-reliability automotive applications targeting zero defects

**TAPE AND REEL INFORMATION**

**QUADRANT ASSIGNMENTS FOR PIN 1 ORIENTATION IN TAPE**

\*All dimensions are nominal

| Device         | Package Type | Package Drawing | Pins | SPQ  | Reel Diameter (mm) | Reel Width W1 (mm) | A0 (mm) | B0 (mm) | K0 (mm) | P1 (mm) | W (mm) | Pin1 Quadrant |
|----------------|--------------|-----------------|------|------|--------------------|--------------------|---------|---------|---------|---------|--------|---------------|
| TPS73701DCQR   | SOT-223      | DCQ             | 6    | 2500 | 330.0              | 12.4               | 6.85    | 7.3     | 1.88    | 8.0     | 12.0   | Q3            |
| TPS73701DCQRG4 | SOT-223      | DCQ             | 6    | 2500 | 330.0              | 12.4               | 7.1     | 7.45    | 1.88    | 8.0     | 12.0   | Q3            |
| TPS73701DRBR   | SON          | DRB             | 8    | 3000 | 330.0              | 12.4               | 3.3     | 3.3     | 1.1     | 8.0     | 12.0   | Q2            |
| TPS73701DRBRM3 | SON          | DRB             | 8    | 3000 | 330.0              | 12.4               | 3.3     | 3.3     | 1.1     | 8.0     | 12.0   | Q2            |
| TPS73701DRBT   | SON          | DRB             | 8    | 250  | 180.0              | 12.4               | 3.3     | 3.3     | 1.1     | 8.0     | 12.0   | Q2            |
| TPS73701DRVR   | WSON         | DRV             | 6    | 3000 | 179.0              | 8.4                | 2.2     | 2.2     | 1.2     | 4.0     | 8.0    | Q2            |
| TPS73701DRVT   | WSON         | DRV             | 6    | 250  | 179.0              | 8.4                | 2.2     | 2.2     | 1.2     | 4.0     | 8.0    | Q2            |
| TPS73718DCQR   | SOT-223      | DCQ             | 6    | 2500 | 330.0              | 12.4               | 6.85    | 7.3     | 1.88    | 8.0     | 12.0   | Q3            |
| TPS73718DCQRG4 | SOT-223      | DCQ             | 6    | 2500 | 330.0              | 12.4               | 7.1     | 7.45    | 1.88    | 8.0     | 12.0   | Q3            |
| TPS73718DRBR   | SON          | DRB             | 8    | 3000 | 330.0              | 12.4               | 3.3     | 3.3     | 1.1     | 8.0     | 12.0   | Q2            |
| TPS73718DRBT   | SON          | DRB             | 8    | 250  | 180.0              | 12.4               | 3.3     | 3.3     | 1.1     | 8.0     | 12.0   | Q2            |
| TPS73725DCQR   | SOT-223      | DCQ             | 6    | 2500 | 330.0              | 12.4               | 6.85    | 7.3     | 1.88    | 8.0     | 12.0   | Q3            |
| TPS73730DRBR   | SON          | DRB             | 8    | 3000 | 330.0              | 12.4               | 3.3     | 3.3     | 1.1     | 8.0     | 12.0   | Q2            |
| TPS73730DRBT   | SON          | DRB             | 8    | 250  | 180.0              | 12.4               | 3.3     | 3.3     | 1.1     | 8.0     | 12.0   | Q2            |
| TPS73733DCQR   | SOT-223      | DCQ             | 6    | 2500 | 330.0              | 12.4               | 6.85    | 7.3     | 1.88    | 8.0     | 12.0   | Q3            |
| TPS73733DCQRG4 | SOT-223      | DCQ             | 6    | 2500 | 330.0              | 12.4               | 7.1     | 7.45    | 1.88    | 8.0     | 12.0   | Q3            |

| Device       | Package Type | Package Drawing | Pins | SPQ  | Reel Diameter (mm) | Reel Width W1 (mm) | A0 (mm) | B0 (mm) | K0 (mm) | P1 (mm) | W (mm) | Pin1 Quadrant |
|--------------|--------------|-----------------|------|------|--------------------|--------------------|---------|---------|---------|---------|--------|---------------|
| TPS73733DRVR | WSON         | DRV             | 6    | 3000 | 179.0              | 8.4                | 2.2     | 2.2     | 1.2     | 4.0     | 8.0    | Q2            |
| TPS73733DRVT | WSON         | DRV             | 6    | 250  | 180.0              | 8.4                | 2.2     | 2.2     | 1.2     | 4.0     | 8.0    | Q2            |
| TPS73734DCQR | SOT-223      | DCQ             | 6    | 2500 | 330.0              | 12.4               | 7.1     | 7.45    | 1.88    | 8.0     | 12.0   | Q3            |

**TAPE AND REEL BOX DIMENSIONS**

\*All dimensions are nominal

| Device         | Package Type | Package Drawing | Pins | SPQ  | Length (mm) | Width (mm) | Height (mm) |
|----------------|--------------|-----------------|------|------|-------------|------------|-------------|
| TPS73701DCQR   | SOT-223      | DCQ             | 6    | 2500 | 356.0       | 356.0      | 35.0        |
| TPS73701DCQRG4 | SOT-223      | DCQ             | 6    | 2500 | 346.0       | 346.0      | 29.0        |
| TPS73701DRBR   | SON          | DRB             | 8    | 3000 | 552.0       | 346.0      | 36.0        |
| TPS73701DRBRM3 | SON          | DRB             | 8    | 3000 | 367.0       | 367.0      | 35.0        |
| TPS73701DRBT   | SON          | DRB             | 8    | 250  | 552.0       | 185.0      | 36.0        |
| TPS73701DRVR   | WSON         | DRV             | 6    | 3000 | 213.0       | 191.0      | 35.0        |
| TPS73701DRVT   | WSON         | DRV             | 6    | 250  | 213.0       | 191.0      | 35.0        |
| TPS73718DCQR   | SOT-223      | DCQ             | 6    | 2500 | 356.0       | 356.0      | 35.0        |
| TPS73718DCQRG4 | SOT-223      | DCQ             | 6    | 2500 | 346.0       | 346.0      | 29.0        |
| TPS73718DRBR   | SON          | DRB             | 8    | 3000 | 356.0       | 356.0      | 35.0        |
| TPS73718DRBT   | SON          | DRB             | 8    | 250  | 210.0       | 185.0      | 35.0        |
| TPS73725DCQR   | SOT-223      | DCQ             | 6    | 2500 | 356.0       | 356.0      | 35.0        |
| TPS73730DRBR   | SON          | DRB             | 8    | 3000 | 356.0       | 356.0      | 35.0        |
| TPS73730DRBT   | SON          | DRB             | 8    | 250  | 210.0       | 185.0      | 35.0        |
| TPS73733DCQR   | SOT-223      | DCQ             | 6    | 2500 | 356.0       | 356.0      | 35.0        |
| TPS73733DCQRG4 | SOT-223      | DCQ             | 6    | 2500 | 346.0       | 346.0      | 41.0        |
| TPS73733DRVR   | WSON         | DRV             | 6    | 3000 | 213.0       | 191.0      | 35.0        |
| TPS73733DRVT   | WSON         | DRV             | 6    | 250  | 213.0       | 191.0      | 35.0        |



---

| Device       | Package Type | Package Drawing | Pins | SPQ  | Length (mm) | Width (mm) | Height (mm) |
|--------------|--------------|-----------------|------|------|-------------|------------|-------------|
| TPS73734DCQR | SOT-223      | DCQ             | 6    | 2500 | 346.0       | 346.0      | 41.0        |

**TUBE**

\*All dimensions are nominal

| Device         | Package Name | Package Type | Pins | SPQ  | L (mm) | W (mm) | T (μm) | B (mm) |
|----------------|--------------|--------------|------|------|--------|--------|--------|--------|
| TPS73701DCQ    | DCQ          | SOT-223      | 6    | 78   | 543    | 8.6    | 3606.8 | 2.67   |
| TPS73701DCQG4  | DCQ          | SOT-223      | 6    | 78   | 532.13 | 8.63   | 3.6    | 3.68   |
| TPS73701DRBR   | DRB          | VSON         | 8    | 3000 | 381    | 4.83   | 2286   | 0      |
| TPS73701DRBRG4 | DRB          | VSON         | 8    | 3000 | 381    | 4.83   | 2286   | 0      |
| TPS73701DRBT   | DRB          | VSON         | 8    | 250  | 381    | 4.83   | 2286   | 0      |
| TPS73718DCQ    | DCQ          | SOT-223      | 6    | 78   | 543    | 8.6    | 3606.8 | 2.67   |
| TPS73725DCQ    | DCQ          | SOT-223      | 6    | 78   | 532.13 | 8.63   | 3.6    | 3.68   |
| TPS73733DCQ    | DCQ          | SOT-223      | 6    | 78   | 543    | 8.6    | 3606.8 | 2.67   |
| TPS73733DCQG4  | DCQ          | SOT-223      | 6    | 78   | 532.13 | 8.63   | 3.6    | 3.68   |
| TPS73734DCQ    | DCQ          | SOT-223      | 6    | 78   | 532.13 | 8.63   | 3.6    | 3.68   |

DCQ0006A

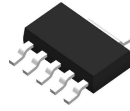

PACKAGE OUTLINE

SOT - 1.8 mm max height

PLASTIC SMALL OUTLINE

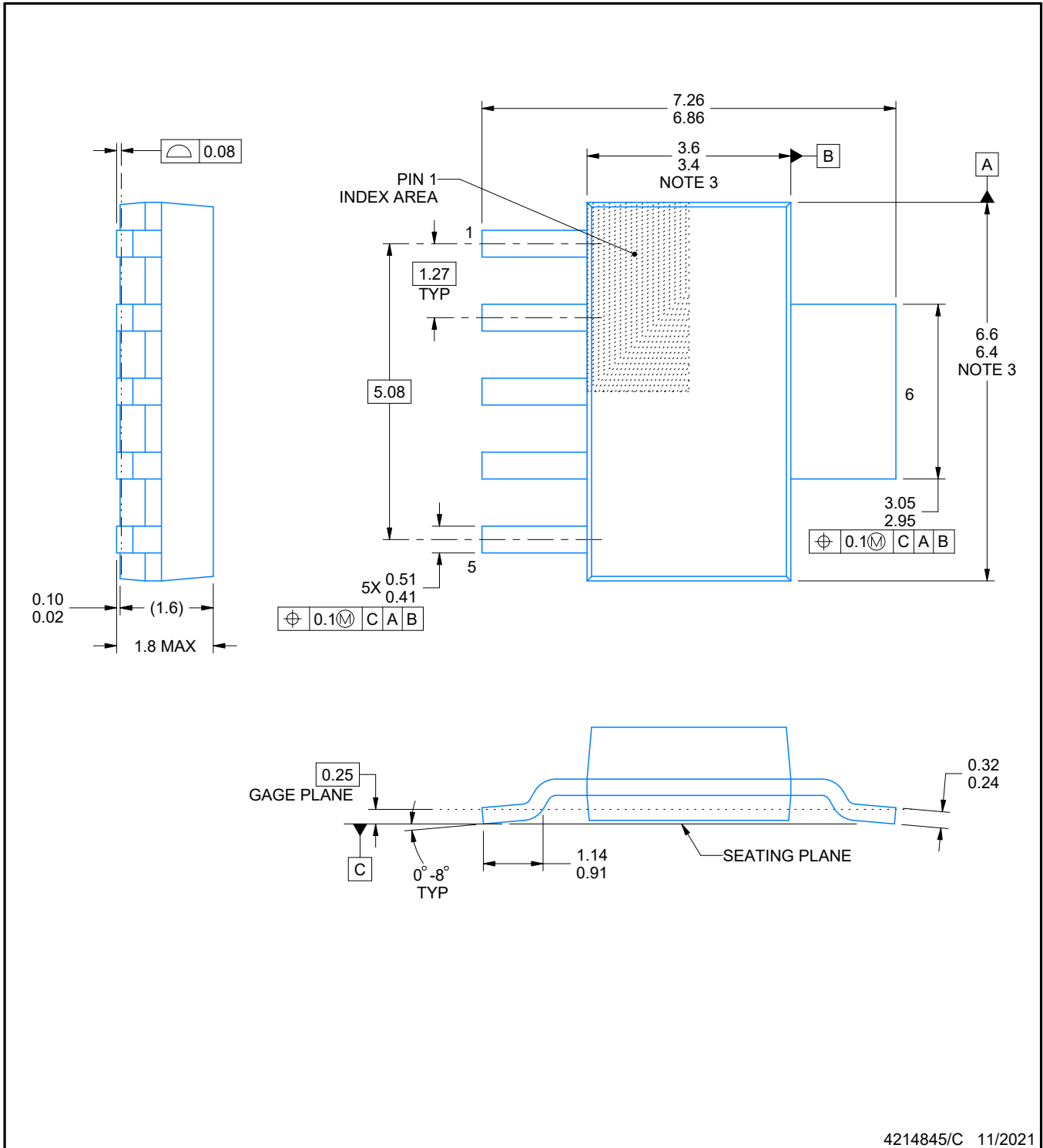

4214845/C 11/2021

NOTES:

1. All linear dimensions are in millimeters. Any dimensions in parenthesis are for reference only. Dimensioning and tolerancing per ASME Y14.5M.
2. This drawing is subject to change without notice.
3. This dimension does not include mold flash, protrusions, or gate burrs. Mold flash, protrusions, or gate burrs shall not exceed 0.15 mm per side.

# EXAMPLE BOARD LAYOUT

DCQ0006A

SOT - 1.8 mm max height

PLASTIC SMALL OUTLINE

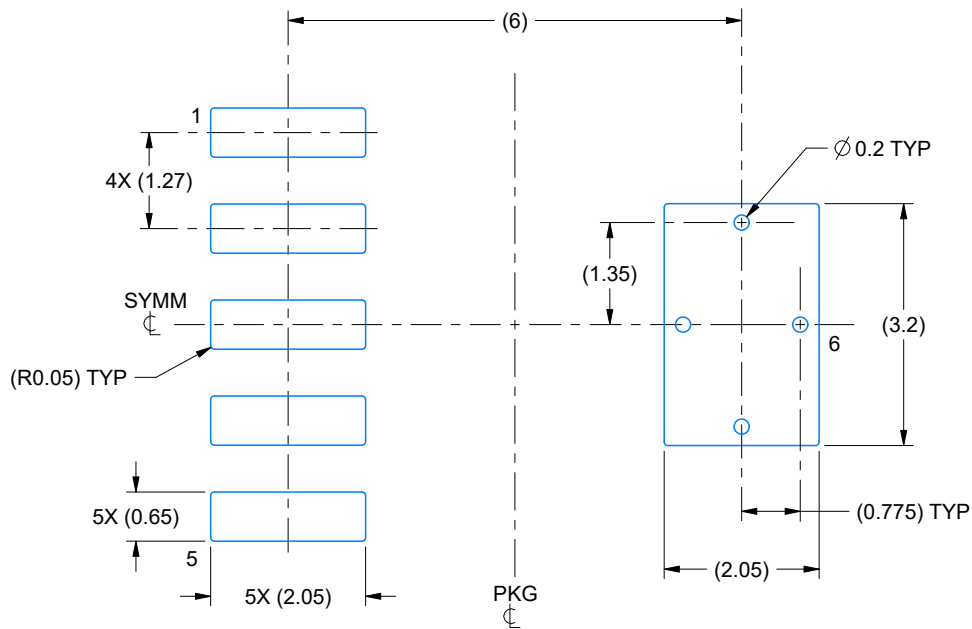

LAND PATTERN EXAMPLE  
EXPOSED METAL SHOWN  
SCALE: 10X

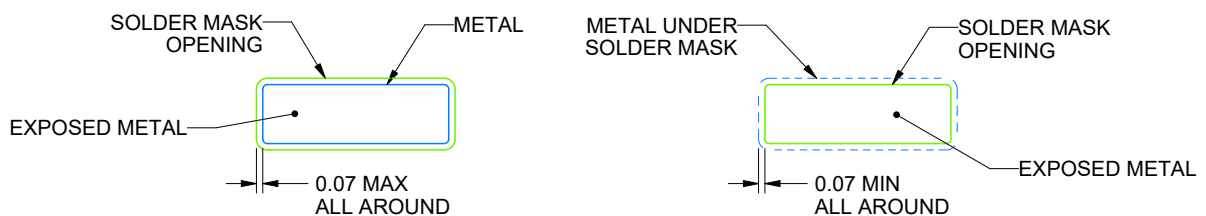

SOLDER MASK DETAILS

4214845/C 11/2021

NOTES: (continued)

4. Publication IPC-7351 may have alternate designs.
5. Solder mask tolerances between and around signal pads can vary based on board fabrication site.
6. Vias are optional depending on application, refer to device data sheet. If any vias are implemented, refer to their locations shown on this view. It is recommended that vias under paste be filled, plugged or tented.

# EXAMPLE STENCIL DESIGN

DCQ0006A

SOT - 1.8 mm max height

PLASTIC SMALL OUTLINE

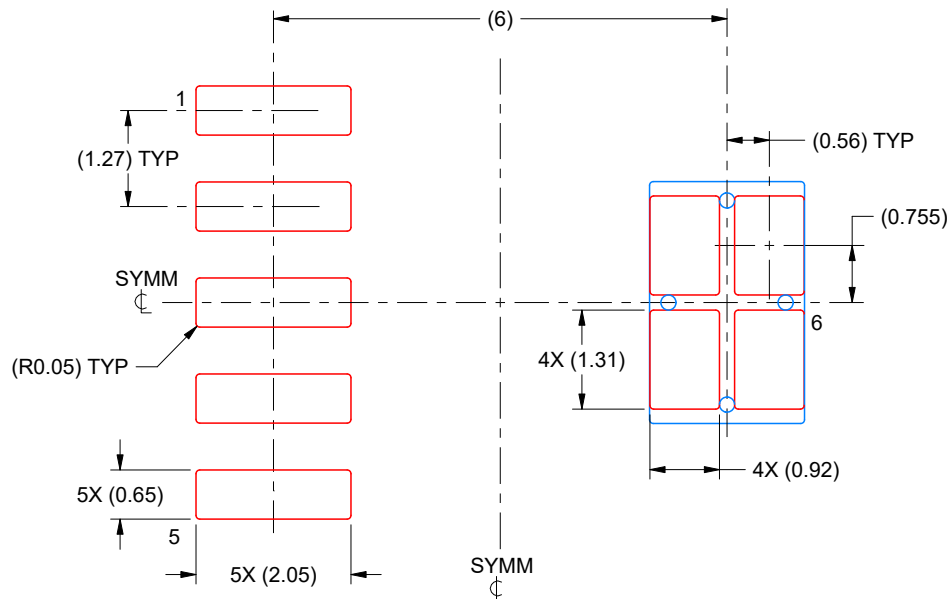

SOLDER PASTE EXAMPLE  
BASED ON 0.125 mm THICK STENCIL  
SCALE: 10X

4214845/C 11/2021

NOTES: (continued)

7. Laser cutting apertures with trapezoidal walls and rounded corners may offer better paste release. IPC-7525 may have alternate design recommendations.
8. Board assembly site may have different recommendations for stencil design.

## GENERIC PACKAGE VIEW

DRV 6

WSON - 0.8 mm max height

PLASTIC SMALL OUTLINE - NO LEAD



Images above are just a representation of the package family, actual package may vary.  
Refer to the product data sheet for package details.

4206925/F



NOTES:

1. All linear dimensions are in millimeters. Any dimensions in parenthesis are for reference only. Dimensioning and tolerancing per ASME Y14.5M.
2. This drawing is subject to change without notice.
3. The package thermal pad must be soldered to the printed circuit board for thermal and mechanical performance.

# EXAMPLE BOARD LAYOUT

DRV0006D

WSON - 0.8 mm max height

PLASTIC SMALL OUTLINE - NO LEAD



LAND PATTERN EXAMPLE  
EXPOSED METAL SHOWN  
SCALE:25X



SOLDER MASK DETAILS

4225563/A 12/2019

NOTES: (continued)

4. This package is designed to be soldered to a thermal pad on the board. For more information, see Texas Instruments literature number SLUA271 ([www.ti.com/lit/sluea271](http://www.ti.com/lit/sluea271)).
5. Vias are optional depending on application, refer to device data sheet. If some or all are implemented, recommended via locations are shown.



# EXAMPLE STENCIL DESIGN

DRV0006D

WSON - 0.8 mm max height

PLASTIC SMALL OUTLINE - NO LEAD



SOLDER PASTE EXAMPLE  
BASED ON 0.125 mm THICK STENCIL

EXPOSED PAD #7  
88% PRINTED SOLDER COVERAGE BY AREA UNDER PACKAGE  
SCALE:30X

4225563/A 12/2019

NOTES: (continued)

6. Laser cutting apertures with trapezoidal walls and rounded corners may offer better paste release. IPC-7525 may have alternate design recommendations.

**DRB 8**

**GENERIC PACKAGE VIEW**

**VSON - 1 mm max height**

PLASTIC SMALL OUTLINE - NO LEAD



Images above are just a representation of the package family, actual package may vary.  
Refer to the product data sheet for package details.

4203482/L



DRB0008B



# PACKAGE OUTLINE

VSON - 1 mm max height

PLASTIC SMALL OUTLINE - NO LEAD

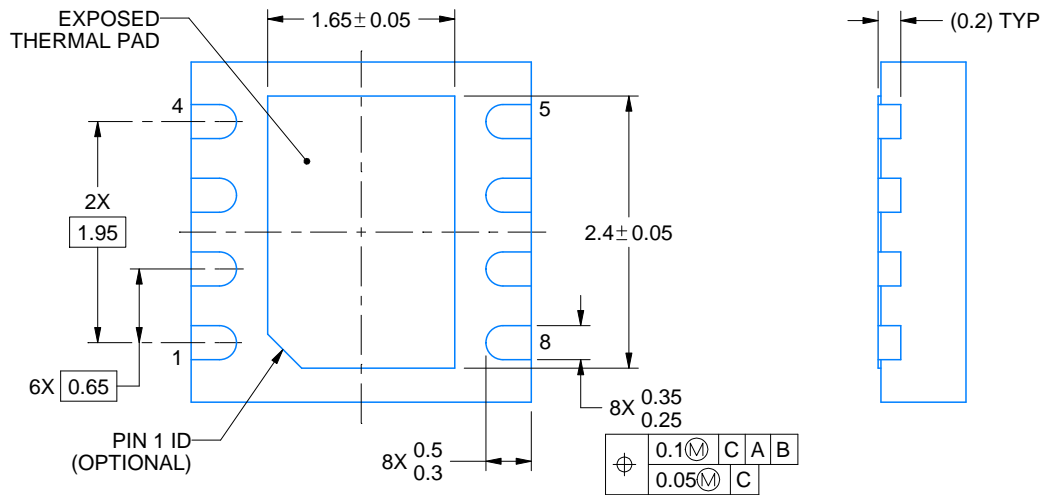
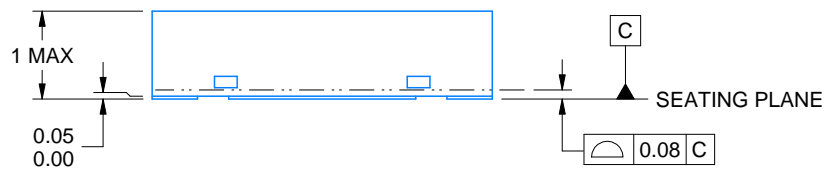
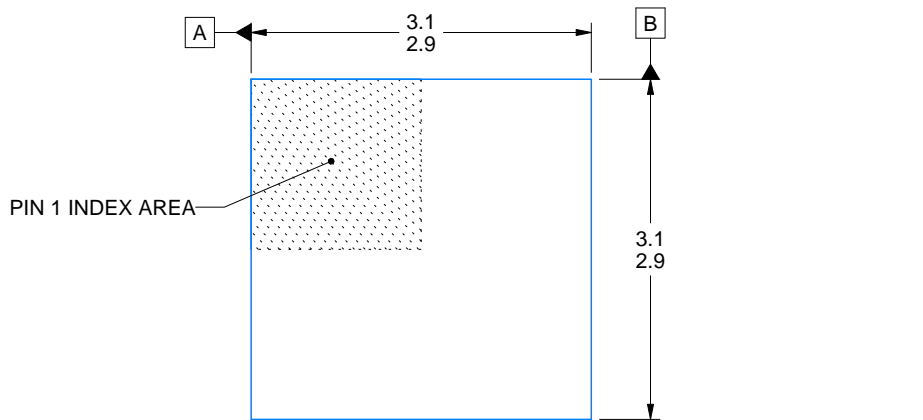

4218876/A 12/2017

## NOTES:

1. All linear dimensions are in millimeters. Any dimensions in parenthesis are for reference only. Dimensioning and tolerancing per ASME Y14.5M.
2. This drawing is subject to change without notice.
3. The package thermal pad must be soldered to the printed circuit board for thermal and mechanical performance.

# EXAMPLE BOARD LAYOUT

DRB0008B

VSON - 1 mm max height

PLASTIC SMALL OUTLINE - NO LEAD



LAND PATTERN EXAMPLE  
SCALE:20X



SOLDER MASK DETAILS

4218876/A 12/2017

NOTES: (continued)

4. This package is designed to be soldered to a thermal pad on the board. For more information, see Texas Instruments literature number SLUA271 ([www.ti.com/lit/sluea271](http://www.ti.com/lit/sluea271)).
5. Vias are optional depending on application, refer to device data sheet. If any vias are implemented, refer to their locations shown on this view. It is recommended that vias under paste be filled, plugged or tented.

# EXAMPLE STENCIL DESIGN

DRB0008B

VSON - 1 mm max height

PLASTIC SMALL OUTLINE - NO LEAD



SOLDER PASTE EXAMPLE  
BASED ON 0.125 mm THICK STENCIL

EXPOSED PAD  
81% PRINTED SOLDER COVERAGE BY AREA  
SCALE:25X

4218876/A 12/2017

NOTES: (continued)

6. Laser cutting apertures with trapezoidal walls and rounded corners may offer better paste release. IPC-7525 may have alternate design recommendations.

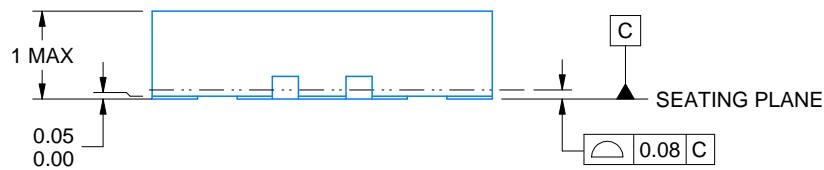
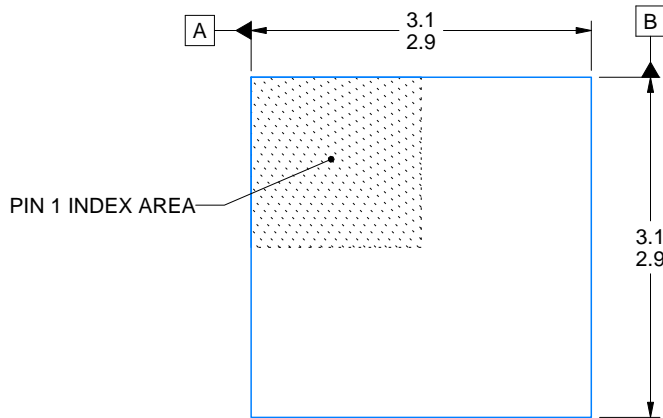

| DIM A |       |
|-------|-------|
| OPT 1 | OPT 2 |
| (0.1) | (0.2) |

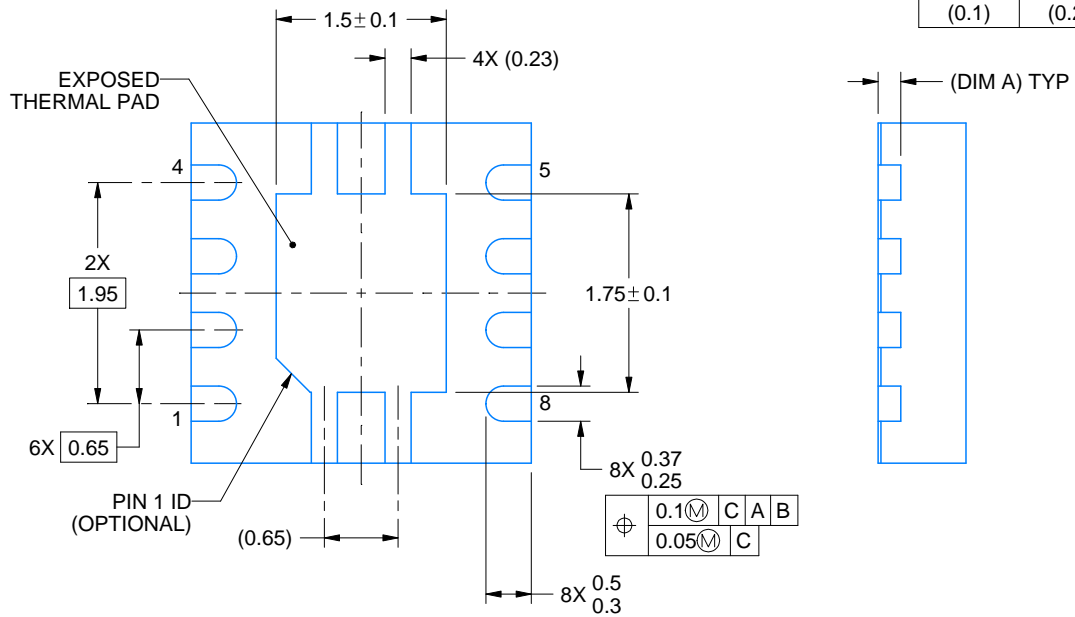

4218875/A 01/2018

NOTES:

1. All linear dimensions are in millimeters. Any dimensions in parenthesis are for reference only. Dimensioning and tolerancing per ASME Y14.5M.
2. This drawing is subject to change without notice.
3. The package thermal pad must be soldered to the printed circuit board for thermal and mechanical performance.

# EXAMPLE BOARD LAYOUT

DRB0008A

VSON - 1 mm max height

PLASTIC SMALL OUTLINE - NO LEAD

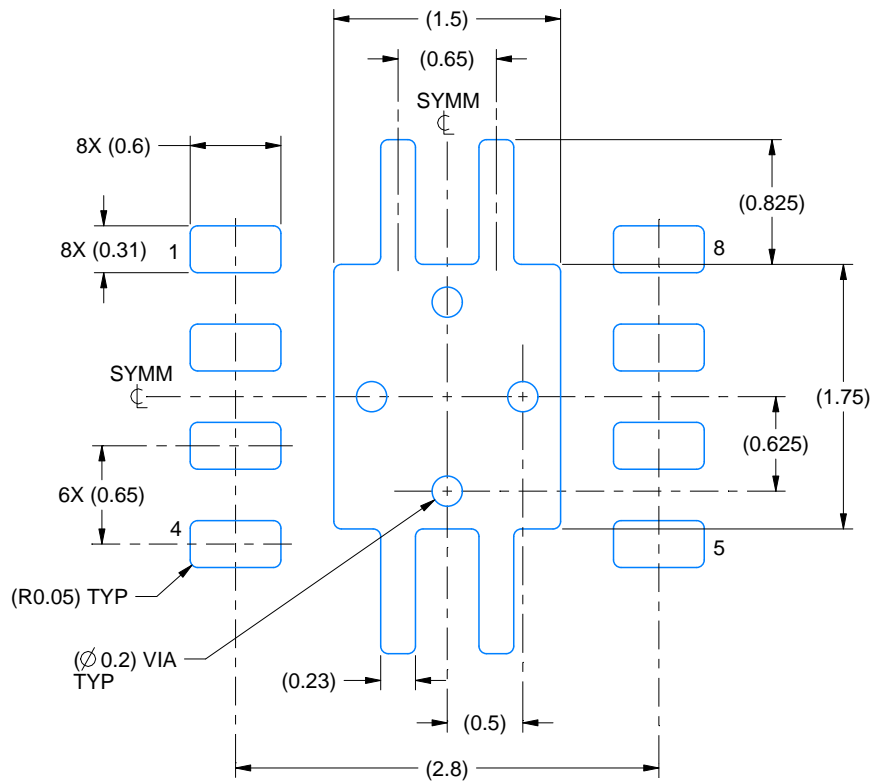

LAND PATTERN EXAMPLE  
EXPOSED METAL SHOWN  
SCALE:20X

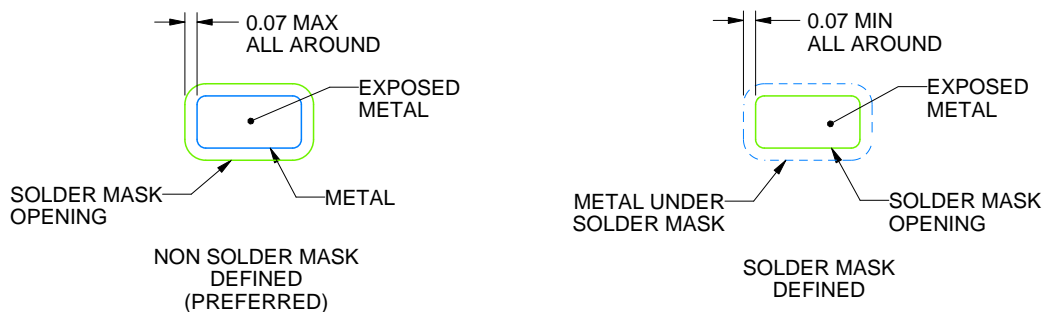

SOLDER MASK DETAILS

4218875/A 01/2018

NOTES: (continued)

4. This package is designed to be soldered to a thermal pad on the board. For more information, see Texas Instruments literature number SLUA271 ([www.ti.com/lit/sluea271](http://www.ti.com/lit/sluea271)).
5. Vias are optional depending on application, refer to device data sheet. If any vias are implemented, refer to their locations shown on this view. It is recommended that vias under paste be filled, plugged or tented.

# EXAMPLE STENCIL DESIGN

DRB0008A

VSON - 1 mm max height

PLASTIC SMALL OUTLINE - NO LEAD



SOLDER PASTE EXAMPLE  
BASED ON 0.125 mm THICK STENCIL

EXPOSED PAD  
84% PRINTED SOLDER COVERAGE BY AREA  
SCALE:25X

4218875/A 01/2018

NOTES: (continued)

6. Laser cutting apertures with trapezoidal walls and rounded corners may offer better paste release. IPC-7525 may have alternate design recommendations.



## IMPORTANT NOTICE AND DISCLAIMER

TI PROVIDES TECHNICAL AND RELIABILITY DATA (INCLUDING DATA SHEETS), DESIGN RESOURCES (INCLUDING REFERENCE DESIGNS), APPLICATION OR OTHER DESIGN ADVICE, WEB TOOLS, SAFETY INFORMATION, AND OTHER RESOURCES "AS IS" AND WITH ALL FAULTS, AND DISCLAIMS ALL WARRANTIES, EXPRESS AND IMPLIED, INCLUDING WITHOUT LIMITATION ANY IMPLIED WARRANTIES OF MERCHANTABILITY, FITNESS FOR A PARTICULAR PURPOSE OR NON-INFRINGEMENT OF THIRD PARTY INTELLECTUAL PROPERTY RIGHTS.

These resources are intended for skilled developers designing with TI products. You are solely responsible for (1) selecting the appropriate TI products for your application, (2) designing, validating and testing your application, and (3) ensuring your application meets applicable standards, and any other safety, security, regulatory or other requirements.

These resources are subject to change without notice. TI grants you permission to use these resources only for development of an application that uses the TI products described in the resource. Other reproduction and display of these resources is prohibited. No license is granted to any other TI intellectual property right or to any third party intellectual property right. TI disclaims responsibility for, and you will fully indemnify TI and its representatives against, any claims, damages, costs, losses, and liabilities arising out of your use of these resources.

TI's products are provided subject to [TI's Terms of Sale](#) or other applicable terms available either on [ti.com](https://www.ti.com) or provided in conjunction with such TI products. TI's provision of these resources does not expand or otherwise alter TI's applicable warranties or warranty disclaimers for TI products.

TI objects to and rejects any additional or different terms you may have proposed.

Mailing Address: Texas Instruments, Post Office Box 655303, Dallas, Texas 75265  
Copyright © 2024, Texas Instruments Incorporated

单击下面可查看定价，库存，交付和生命周期等信息

[>>TI\(德州仪器\)](#)