

# CC1125 超高性能射频 (RF) 窄带收发器

## 1 器件概述

### 1.1 特性

- 高性能、单芯片收发器
  - 邻信道选择性: 6.25kHz 偏移时为 67dB
  - 阻断性能: 10MHz 时为 104dB
  - 出色的接收器灵敏度:
    - 300bps 时为 -129dBm
    - 1.2kbps 时为 -123dBm
    - 50kbps 时为 -110dBm
  - 极低相位噪声: 10kHz 偏移时为 -115dBc/Hz
- 适合于面向 ETSI Category 1 的系统
- 独立的 128 字节 RX 和 TX 先进先出 (FIFO)
- 支持与 CC1190 器件无缝集成以实现范围扩展, 从而使灵敏度提升 3dB 并且实现高达 +27dBm 的输出功率
- 高频谱效率 (12.5kHz 信道中为 9.6kbps, 符合 FCC 窄带要求)
- 电源
  - 宽电源电压范围 (2.0V 至 3.6V)
  - 低功耗:
    - RX: 在 RX 嗅探模式中为 2mA
    - RX: 在低功率模式中, 峰值电流为 17mA
    - RX: 在高性能模式中, 峰值电流为 26mA
    - TX: +14dBm 时为 47mA
  - 断电: 0.12 $\mu$ A (增强型无线电唤醒 (eWOR) 定时器运行时为 0.5 $\mu$ A)
- 步长为 0.4dB 时可编程输出功率高达 +16dBm
- 自动输出功率递增
- 可配置数据速率: 0 至 200kbps
- 所支持的调制格式: 2 - 频移键控 (FSK), 2 - 高斯频移键控 (GFSK), 4-FSK, 4-GFSK, 最小频移键控 (MSK), 开关键控 (OOK)
- 波形监视: 针对经改进同步检测性能的高级数字信号处理
- 符合 RoHS 标准的 5mm x 5mm 无脚四方扁平无引线 (QFN) 32 引脚封装 (RHB)
- 法规 - 适用于符合下列标准的系统
  - 欧洲: ETSI EN 300 220 Category 1, ETSI EN 54-25, ETSI EN 300 113 和 EN 301 166
  - 美国: FCC CFR47 部分 15, 24, 90, 101
  - 日本: ARIB RCR STD-T30, T-67, T-108
- 外设和支持功能
  - 针对自动低功率接收轮询的 eWOR 功能
  - 包括针对天线多样性支持的功能
  - 支持重传
  - 支持自动确认接收到的数据包
  - TCXO 支持和控制, 同样适用于功率模式
  - 针对载波监听 (LBT) 系统的自动空闲信道评估 (CCA)
  - 增加范围和提高稳定耐用性的内置编码增益支持
  - 数字接收信号强度指示 (RSSI) 测量
  - 温度传感器

### 1.2 应用范围

- 警报系统
- 信道间隔低至 4kHz 的窄带超低功率无线系统
- 169、315、433、868、915、920、950MHz ISM/SRD 频带系统
- 无线计量和无线智能电网 (自动计量读取 (AMR) 和自动计量基础设施 (AMI))
- IEEE 802.15.4g 系统
- 家庭和楼宇自动化
- 无线警报和安全系统
- 工业用监控和控制
- 无线医疗应用
- 无线传感器网络和有源射频识别 (RFID)
- 私人移动无线电通信

### 1.3 说明

CC1125 是一款全集成单芯片射频收发器, 此器件设计用于在成本有效无线系统中实现极低功耗和低压运行的高性能。所有滤波器都已集成, 因此无需昂贵的外部表面声波 (SAW) 和中频 (IF) 滤波器。该器件主要用于 ISM (工业、科学和医疗) 以及处于 164-192MHz, 274-320MHz, 410-480MHz 和 820-960MHz 的 SRD (短程设备) 频带。

CC1125 器件提供广泛硬件支持, 以实现数据包处理、数据缓冲、突发传输、空闲信道评估、链路质量指示和无线电唤醒。CC1125 器件的主要运行参数可由 SPI 接口控制。在典型系统中, CC1125 器件将与微控制器和极少的外部无源组件配合使用。



器件信息(1)

部件号	封装	封装尺寸
CC1125RHB	超薄四方扁平无引线 (VQFN) (32)	5.00mm x 5.00mm

(1) 更多信息请参见 节 8, 机械封装和可订购产品信息

1.4 功能方框图

图 1-1 显示 CC1125 器件的系统方框图。

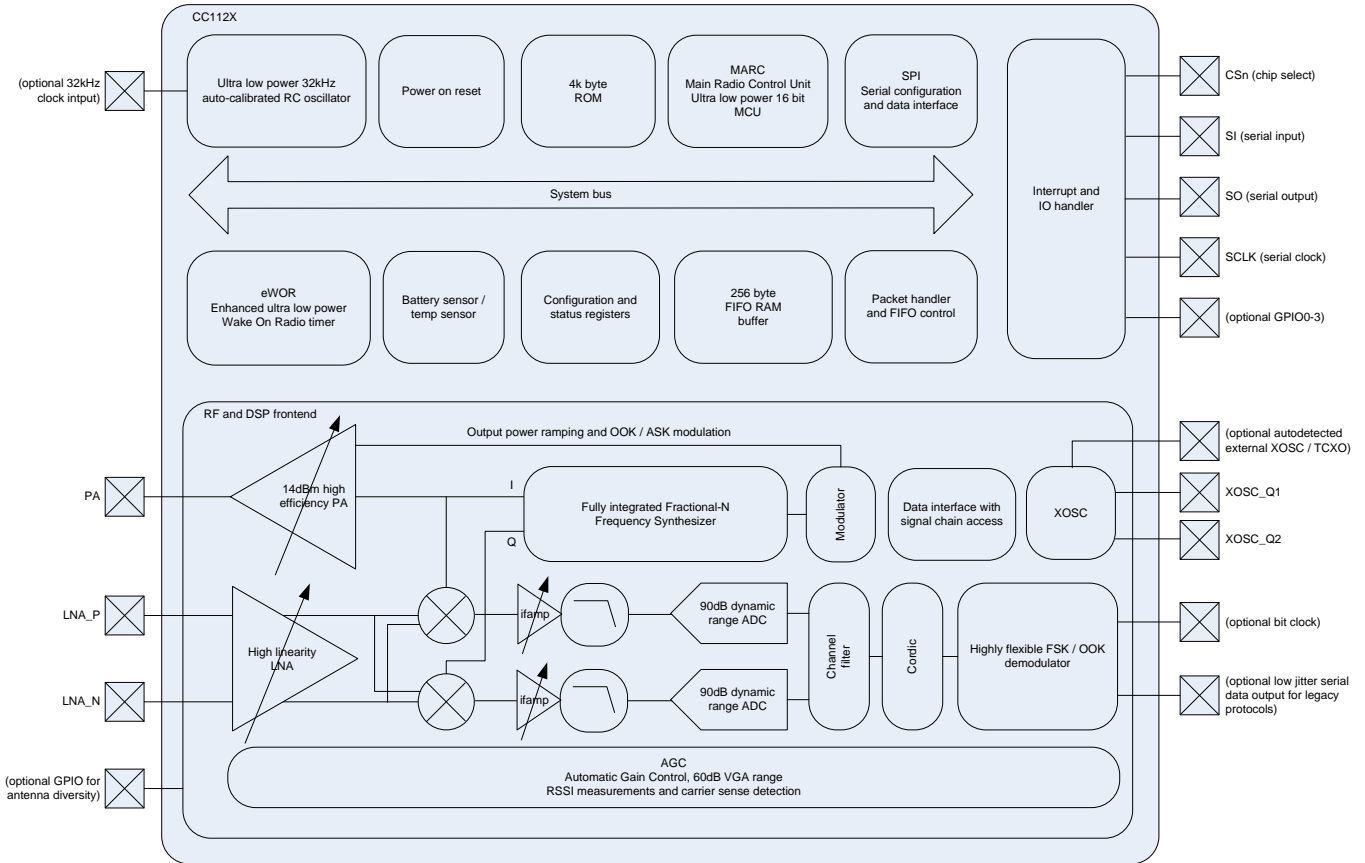


图 1-1. 功能方框图

## 内容

<b>1</b>	<b>器件概述</b> .....	<b>1</b>	4.15	High-Speed Clock Input (TCXO) .....	<b>19</b>
1.1	特性 .....	<b>1</b>	4.16	32-kHz Clock Input .....	<b>19</b>
1.2	应用范围 .....	<b>1</b>	4.17	Low Speed RC Oscillator .....	<b>20</b>
1.3	说明 .....	<b>1</b>	4.18	I/O and Reset .....	<b>20</b>
1.4	功能方框图 .....	<b>2</b>	4.19	Temperature Sensor .....	<b>20</b>
<b>2</b>	<b>修订历史记录</b> .....	<b>4</b>	4.20	Typical Characteristics .....	<b>21</b>
<b>3</b>	<b>Terminal Configuration and Functions</b> .....	<b>5</b>	<b>5</b>	<b>Detailed Description</b> .....	<b>24</b>
3.1	Pin Diagram .....	<b>5</b>	5.1	Block Diagram .....	<b>24</b>
3.2	Pin Configuration .....	<b>6</b>	5.2	Frequency Synthesizer .....	<b>24</b>
<b>4</b>	<b>Specifications</b> .....	<b>7</b>	5.3	Receiver .....	<b>25</b>
4.1	Absolute Maximum Ratings .....	<b>7</b>	5.4	Transmitter .....	<b>25</b>
4.2	Handling Ratings .....	<b>7</b>	5.5	Radio Control and User Interface .....	<b>25</b>
4.3	Recommended Operating Conditions (General Characteristics) .....	<b>7</b>	5.6	4.5 Enhanced Wake-On-Radio (eWOR) .....	<b>25</b>
4.4	Thermal Resistance Characteristics for RHB Package .....	<b>7</b>	5.7	Sniff Mode .....	<b>26</b>
4.5	RF Characteristics .....	<b>8</b>	5.8	Antenna Diversity .....	<b>26</b>
4.6	Regulatory Standards .....	<b>8</b>	5.9	WaveMatch .....	<b>27</b>
4.7	Current Consumption, Static Modes .....	<b>9</b>	<b>6</b>	<b>Typical Application Circuit</b> .....	<b>28</b>
4.8	Current Consumption, Transmit Modes .....	<b>9</b>	<b>7</b>	<b>器件和文档支持</b> .....	<b>29</b>
4.9	Current Consumption, Receive Modes .....	<b>10</b>	7.1	器件支持 .....	<b>29</b>
4.10	Receive Parameters .....	<b>11</b>	7.2	文档支持 .....	<b>30</b>
4.11	Transmit Parameters .....	<b>17</b>	7.3	社区资源 .....	<b>30</b>
4.12	PLL Parameters .....	<b>18</b>	7.4	商标 .....	<b>30</b>
4.13	Wake-up and Timing .....	<b>19</b>	7.5	静电放电警告 .....	<b>30</b>
4.14	High-Speed Crystal Oscillator .....	<b>19</b>	7.6	术语表 .....	<b>30</b>
			<b>8</b>	<b>机械封装和可订购信息</b> .....	<b>31</b>

## 2 修订历史记录

NOTE: Page numbers for previous revisions may differ from page numbers in the current version.

本数据手册修订历史记录强调了使 SWRS120D 器件专用数据手册变为 SWRS120E 修订版本所做的更改。

Changes from Revision D (June 2014) to Revision E	Page
• Added Ambient to the temperature range condition and removed Tj from Temperature range .....	<a href="#">7</a>
• Added data to TCXO table .....	<a href="#">19</a>

### 3 Terminal Configuration and Functions

#### 3.1 Pin Diagram

Figure 3-1 shows pin names and locations for the CC1125 device.

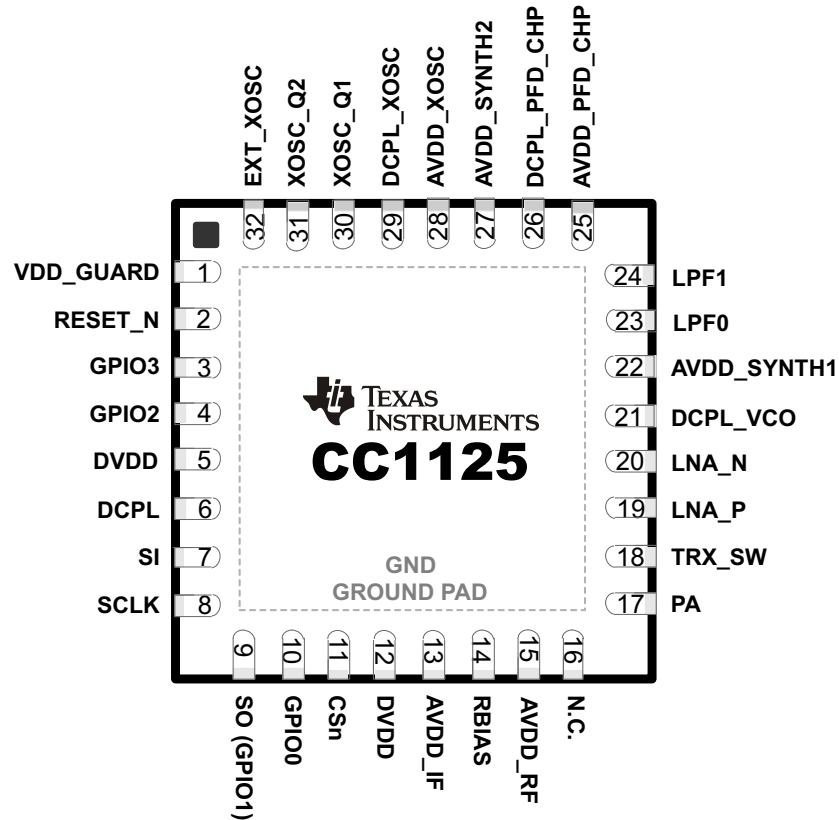


Figure 3-1. Package 5-mm x 5-mm QFN

## 3.2 Pin Configuration

The following table lists the pin-out configuration for the CC1125 device.

PIN NO.	PIN NAME	TYPE / DIRECTION	DESCRIPTION
1	VDD_GUARD	Power	2.0–3.6 V VDD
2	RESET_N	Digital input	Asynchronous, active-low digital reset
3	GPIO3	Digital I/O	General-purpose I/O
4	GPIO2	Digital I/O	General-purpose I/O
5	DVDD	Power	2.0–3.6 VDD to internal digital regulator
6	DCPL	Power	Digital regulator output to external decoupling capacitor
7	SI	Digital input	Serial data in
8	SCLK	Digital input	Serial data clock
9	SO(GPIO1)	Digital I/O	Serial data out (general-purpose I/O)
10	GPIO0	Digital I/O	General-purpose I/O
11	CSn	Digital input	Active-low chip select
12	DVDD	Power	2.0–3.6 V VDD
13	AVDD_IF	Power	2.0–3.6 V VDD
14	RBIAS	Analog	External high-precision resistor
15	AVDD_RF	Power	2.0–3.6 V VDD
16	N.C.		Not connected
17	PA	Analog	Single-ended TX output (requires DC path to VDD)
18	TRX_SW	Analog	TX and RX switch. Connected internally to GND in TX and floating (high-impedance) in RX.
19	LNA_P	Analog	Differential RX input (requires DC path to GND)
20	LNA_N	Analog	Differential RX input (requires DC path to GND)
21	DCPL_VCO	Power	Pin for external decoupling of VCO supply regulator
22	AVDD_SYNTH1	Power	2.0–3.6 V VDD
23	LPF0	Analog	External loop filter components
24	LPF1	Analog	External loop filter components
25	AVDD_PFD_CHP	Power	2.0–3.6 V VDD
26	DCPL_PFD_CHP	Power	Pin for external decoupling of PFD and CHP regulator
27	AVDD_SYNTH2	Power	2.0–3.6 V VDD
28	AVDD_XOSC	Power	2.0–3.6 V VDD
29	DCPL_XOSC	Power	Pin for external decoupling of XOSC supply regulator
30	XOSC_Q1	Analog	Crystal oscillator pin 1 (must be grounded if a TCXO or other external clock connected to EXT_XOSC is used)
31	XOSC_Q2	Analog	Crystal oscillator pin 2 (must be left floating if a TCXO or other external clock connected to EXT_XOSC is used)
32	EXT_XOSC	Digital input	Pin for external clock input (must be grounded if a regular crystal connected to XOSC_Q1 and XOSC_Q2 is used)
–	GND	Ground pad	The ground pad must be connected to a solid ground plane.

## 4 Specifications

All measurements performed on CC1120EM\_868\_915 rev.1.0.1, CC1120EM\_955 rev.1.2.1, CC1120EM\_420\_470 rev.1.0.1 or CC1120EM\_169 rev.1.2 ( $f_{\text{xosc}} = 32$  MHz), and CC1125EM\_868\_915 rev.1.1.0, CC1125EM\_420\_470 rev.1.1.0, CC1125EM\_169 rev.1.1.0, CC1125EM-Cat1-868 ( $f_{\text{xosc}} = 40$  MHz).

### 4.1 Absolute Maximum Ratings<sup>(1)(2)</sup>

PARAMETER	MIN	MAX	UNIT	CONDITION
Supply voltage (VDD, AVDD_x)	-0.3	3.9	V	All supply pins must have the same voltage
Solder reflow temperature		260	°C	According to IPC/JEDEC J-STD-020
Input RF level		+10	dBm	
Voltage on any digital pin	-0.3	VDD+0.3	V	max 3.9
Voltage on analog pins (including DCPL pins)	-0.3	2.0	V	

- Stresses beyond those listed under absolute maximum ratings may cause permanent damage to the device. These are stress ratings only, and functional operation of the device at these or any other conditions beyond those indicated under general characteristics is not implied. Exposure to absolute-maximum-rated conditions for extended periods may affect device reliability.
- All voltage values are with respect to  $V_{\text{SS}}$ , unless otherwise noted.

### 4.2 Handling Ratings

		MIN	MAX	UNIT
$T_{\text{stg}}$	Storage temperature range	-40	125	°C
$V_{\text{ESD}}$	Electrostatic discharge (ESD) performance:	Human body model (HBM), per ANSI/ESDA/JEDEC JS001 <sup>(1)</sup>		kV
		Charged device model (CDM), per JESD22-C101 <sup>(2)</sup>		V
		-500	500	All pins

- JEDEC document JEP155 states that 500-V HBM allows safe manufacturing with a standard ESD control process.
- JEDEC document JEP157 states that 250-V HBM allows safe manufacturing with a standard ESD control process.

### 4.3 Recommended Operating Conditions (General Characteristics)

PARAMETER	MIN	TYP	MAX	UNIT	CONDITION
Voltage supply range	2.0		3.6	V	All supply pins must have the same voltage
Voltage on digital inputs	0		VDD	V	
Temperature range	-40		85	°C	Ambient

### 4.4 Thermal Resistance Characteristics for RHB Package

	°C/W <sup>(1)</sup>	AIR FLOW (m/s) <sup>(2)</sup>
$R\theta_{\text{JC}}$ Junction-to-case (top)	21.1	0.00
$R\theta_{\text{JB}}$ Junction-to-board	5.3	0.00
$R\theta_{\text{JA}}$ Junction-to-free air	31.3	0.00
$\Psi_{\text{JT}}$ Junction-to-package top	0.2	0.00
$\Psi_{\text{JB}}$ Junction-to-board	5.3	0.00
$R\theta_{\text{JC}}$ Junction-to-case (bottom)	0.8	0.00

- These values are based on a JEDEC-defined 2S2P system (with the exception of the Theta JC [ $R\theta_{\text{JC}}$ ] value, which is based on a JEDEC-defined 1S0P system) and will change based on environment as well as application. For more information, see these EIA/JEDEC standards:
  - JESD51-2, *Integrated Circuits Thermal Test Method Environmental Conditions - Natural Convection (Still Air)*
  - JESD51-3, *Low Effective Thermal Conductivity Test Board for Leaded Surface Mount Packages*
  - JESD51-7, *High Effective Thermal Conductivity Test Board for Leaded Surface Mount Packages*
  - JESD51-9, *Test Boards for Area Array Surface Mount Package Thermal Measurements*
Power dissipation of 40 mW and an ambient temperature of 25°C is assumed.
- m/s = meters per second

## 4.5 RF Characteristics

PARAMETER	MIN	TYP	MAX	UNIT	CONDITION
Frequency bands	820		960	MHz	
	410		480	MHz	
	(273.3)		(320)	MHz	See <a href="#">SWRA398</a> for more information.
	164		192	MHz	
	(205)		(240)	MHz	Contact TI for more information about the use of these frequency bands.
(136.7)		(160)	MHz		
Frequency resolution		30		Hz	In 820–950 MHz band
		15		Hz	In 410–480 MHz band
		6		Hz	In 164–192 MHz band
Data rate	0		200	kbps	Packet mode
	0		100	kbps	Transparent mode
Data rate step size		1e-4		bps	

## 4.6 Regulatory Standards

PERFORMANCE MODE	Frequency Band	Suitable for compliance with	Comments
High-performance mode	820–960 MHz	ARIB T-108 ARIB T-96 ETSI EN 300 220 category 1 ETSI EN 54-25 FCC PART 101 FCC PART 24 SUBMASK D FCC PART 15.247 FCC PART 15.249 FCC PART 90 MASK G FCC PART 90 MASK J	Performance also suitable for systems targeting maximum allowed output power in the respective bands, using a range extender such as the CC1190 device
	410–480 MHz	ARIB T-67 ARIB RCR STD-30 ETSI EN 301 166 ETSI EN 300 113 ETSI EN 300 220 category 1 FCC PART 90 MASK D FCC PART 90 MASK E FCC PART 90 MASK G	Performance also suitable for systems targeting maximum allowed output power in the respective bands, using a range extender
	164–192 MHz	ETSI EN 300 220 category 1 ETSI EN 301 166 ETSI EN 300 113 FCC PART 90 MASK C FCC PART 90 MASK D FCC PART 90 MASK E	Performance also suitable for systems targeting maximum allowed output power in the respective bands, using a range extender
Low-power mode	820–960 MHz	ETSI EN 300 220 category 2 FCC PART 15.247 FCC PART 15.249	
	410–480 MHz	ETSI EN 300 220 category 2	
	164–192 MHz	ETSI EN 300 220 category 2	



## 4.7 Current Consumption, Static Modes

 $T_A = 25^\circ\text{C}$ ,  $V_{DD} = 3.0\text{ V}$ ,  $f_{\text{xosc}} = 32\text{ MHz}$  if nothing else stated.

PARAMETER	MIN	TYP	MAX	UNIT	CONDITION
Power down with retention		0.12	1	$\mu\text{A}$	
		0.5		$\mu\text{A}$	Low-power RC oscillator running
XOFF mode		170		$\mu\text{A}$	Crystal oscillator / TCXO disabled
IDLE mode		1.3		$\text{mA}$	Clock running, system waiting with no radio activity

## 4.8 Current Consumption, Transmit Modes

### 4.8.1 950-MHz Band (High-Performance Mode)

 $T_A = 25^\circ\text{C}$ ,  $V_{DD} = 3.0\text{ V}$ ,  $f_{\text{xosc}} = 32\text{ MHz}$  if nothing else stated

PARAMETER	MIN	TYP	MAX	UNIT	CONDITION
TX current consumption +10 dBm		37		$\text{mA}$	
TX current consumption 0 dBm		26		$\text{mA}$	

### 4.8.2 868-, 915-, and 920-MHz Bands (High-Performance Mode)

 $T_A = 25^\circ\text{C}$ ,  $V_{DD} = 3.0\text{ V}$ ,  $f_{\text{xosc}} = 40\text{ MHz}$  if nothing else stated

PARAMETER	MIN	TYP	MAX	UNIT	CONDITION
TX current consumption +14 dBm		47		$\text{mA}$	
TX current consumption +10 dBm		38		$\text{mA}$	

### 4.8.3 434-MHz Band (High-Performance Mode)

 $T_A = 25^\circ\text{C}$ ,  $V_{DD} = 3.0\text{ V}$ ,  $f_{\text{xosc}} = 40\text{ MHz}$  if nothing else stated

PARAMETER	MIN	TYP	MAX	UNIT	CONDITION
TX current consumption +15 dBm		51		$\text{mA}$	
TX current consumption +14 dBm		47		$\text{mA}$	
TX current consumption +10 dBm		36		$\text{mA}$	

### 4.8.4 169-MHz Band (High Performance Mode)

 $T_A = 25^\circ\text{C}$ ,  $V_{DD} = 3.0\text{ V}$ ,  $f_{\text{xosc}} = 40\text{ MHz}$  if nothing else stated

PARAMETER	MIN	TYP	MAX	UNIT	CONDITION
TX current consumption +15 dBm		56		$\text{mA}$	
TX current consumption +14 dBm		52		$\text{mA}$	
TX current consumption +10 dBm		40		$\text{mA}$	

### 4.8.5 Low-Power Mode

 $T_A = 25^\circ\text{C}$ ,  $V_{DD} = 3.0\text{ V}$ ,  $f_c = 869.5\text{ MHz}$ ,  $f_{\text{xosc}} = 32\text{ MHz}$  if nothing else stated

PARAMETER	MIN	TYP	MAX	UNIT	CONDITION
TX current consumption +10 dBm		32		$\text{mA}$	

## 4.9 Current Consumption, Receive Modes

### 4.9.1 High-Performance Mode

$T_A = 25^\circ\text{C}$ ,  $V_{DD} = 3.0\text{ V}$ ,  $f_c = 869.5\text{ MHz}$ ,  $f_{xosc} = 32\text{ MHz}$  if nothing else stated

PARAMETER	MIN	TYP	MAX	UNIT	CONDITION
RX wait for sync 1.2 kbps, 4-byte preamble 38.4 kbps, 4-byte preamble		2 13.4		mA mA	Using RX sniff mode, where the receiver wakes up at regular intervals to look for an incoming packet
RX peak current, $f_{xosc} = 40\text{ MHz}$ 433-, 868-, 915-, and 920-MHz bands 169-MHz band		26 27		mA mA	Peak current consumption during packet reception at the sensitivity threshold
Average current consumption Check for data packet every 1 second using wake on radio		15		$\mu\text{A}$	50 kbps, 5-byte preamble, 40-kHz RC oscillator used as sleep timer

### 4.9.2 Low-Power Mode

$T_A = 25^\circ\text{C}$ ,  $V_{DD} = 3.0\text{ V}$ ,  $f_c = 869.5\text{ MHz}$ ,  $f_{xosc} = 32\text{ MHz}$  if nothing else stated

PARAMETER	MIN	TYP	MAX	UNIT	CONDITION
RX peak current low-power RX mode 1.2 kbps		17		mA	Peak current consumption during packet reception at the sensitivity level

## 4.10 Receive Parameters

All RX measurements made at the antenna connector, to a bit error rate (BER) limit of 1%.

### 4.10.1 General Receive Parameters (High-Performance Mode)

$T_A = 25^\circ\text{C}$ ,  $V_{DD} = 3.0\text{ V}$ ,  $f_c = 869.5\text{ MHz}$  if nothing else stated

PARAMETER	MIN	TYP	MAX	UNIT	CONDITION
Saturation		+10		dBm	
Digital channel filter programmable bandwidth					
$f_{\text{xosc}} = 32\text{ MHz}$	2.8		200	kHz	
$f_{\text{xosc}} = 40\text{ MHz}$	3.5		250	kHz	
IIP3, normal mode		-14		dBm	At maximum gain
IIP3, high linearity mode		-8		dBm	Using 6-dB gain reduction in front end
Datarate offset tolerance		$\pm 12$		%	With carrier sense detection enabled and assuming 4-byte preamble
		$\pm 0.2$		%	With carrier sense detection disabled
Spurious emissions					
1–13 GHz (VCO leakage at 3.5 GHz)		-56		dBm	Radiated emissions measured according to ETSI EN 300 220, $f_c = 869.5\text{ MHz}$
30 MHz to 1 GHz		< -57		dBm	
Optimum source impedance					(Differential or single-ended RX configurations)
868-, 915-, and 920-MHz bands		$60 + j60 / 30 + j30$		$\Omega$	
433-MHz band		$100 + j60 / 50 + j30$		$\Omega$	
169-MHz band		$140 + j40 / 70 + j20$		$\Omega$	

#### 4.10.2 RX Performance in 950-MHz Band (High-Performance Mode)

$T_A = 25^\circ\text{C}$ ,  $V_{DD} = 3.0\text{ V}$ ,  $f_{xosc} = 32\text{ MHz}$  if nothing else stated

PARAMETER	MIN	TYP	MAX	UNIT	CONDITION
Sensitivity Note: Sensitivity can be improved if the TX and RX matching networks are separated.		-120		dBm	1.2 kbps, DEV=4 kHz CHF=10 kHz <sup>(1)</sup>
		-107		dBm	50 kbps 2GFSK, DEV=25 kHz, CHF=100 kHz
		-100		dBm	200 kbps, DEV=83 kHz (outer symbols), CHF=200 kHz, 4GFSK <sup>(2)</sup>
Blocking and Selectivity 1.2 kbps 2-FSK, 12.5-kHz channel separation, 4-kHz deviation, 10-kHz channel filter		51		dB	$\pm 12.5\text{ kHz}$ (adjacent channel)
		52		dB	$\pm 25\text{ kHz}$ (alternate channel)
		73		dB	$\pm 1\text{ MHz}$
		76		dB	$\pm 2\text{ MHz}$
Blocking and Selectivity 50 kbps 2-GFSK, 200-kHz channel separation, 25-kHz deviation, 100-kHz channel filter (Same modulation format as 802.15.4g Mandatory Mode)		43		dB	$\pm 200\text{ kHz}$ (adjacent channel)
		51		dB	$\pm 400\text{ kHz}$ (alternate channel)
		62		dB	$\pm 1\text{ MHz}$
		65		dB	$\pm 2\text{ MHz}$
Blocking and Selectivity 200 kbps 4-GFSK, 83-kHz deviation (outer symbols), 200-kHz channel filter, zero IF		71		dB	$\pm 10\text{ MHz}$
		37		dB	$\pm 200\text{ kHz}$ (adjacent channel)
		44		dB	$\pm 400\text{ kHz}$ (alternate channel)
		55		dB	$\pm 1\text{ MHz}$
	58		dB	$\pm 2\text{ MHz}$	
	64		dB	$\pm 10\text{ MHz}$	

(1) DEV is short for deviation, CHF is short for channel filter bandwidth

(2) BT=0.5 is used in all GFSK measurements

### 4.10.3 RX Performance in 868-, 915-, and 920-MHz Bands (High-Performance Mode)

$T_A = 25^\circ\text{C}$ ,  $V_{DD} = 3.0\text{ V}$ ,  $f_{\text{xosc}} = 32\text{ MHz}$  if nothing else stated if nothing else stated

PARAMETER	MIN	TYP	MAX	UNIT	CONDITION
Sensitivity		-129		dBm	300 bps, DEV=1 kHz CHF=3.8 kHz <sup>(1)</sup> , $f_{\text{xosc}} = 40\text{ MHz}$
		-123		dBm	1.2 kbps, DEV=20 kHz CHF=50 kHz
		-114		dBm	4.8 kbps OOK
		-110		dBm	38.4 kbps, DEV=20 kHz CHF=100 kHz
		-110		dBm	50 kbps 2GFSK, DEV=25 kHz, CHF=100 kHz
Blocking and Selectivity 0.3-kbps 2-FSK, 6.25-kHz channel separation, 1-kHz deviation, 3.8-kHz channel filter $f_{\text{xosc}} = 40\text{ MHz}$ using TCXO		62		dB	$\pm 6.25\text{ kHz}$ (adjacent channel)
		63		dB	$\pm 12.5\text{ kHz}$ (alternate channel)
		83		dB	$\pm 1\text{ MHz}$
		87		dB	$\pm 2\text{ MHz}$
		91		dB	$\pm 10\text{ MHz}$
Blocking and Selectivity 1.2-kbps 2-FSK, 12.5-kHz channel separation, 4-kHz deviation, 10-kHz channel filter $f_{\text{xosc}} = 40\text{ MHz}$ using TCXO		58		dB	+ 12.5 kHz (adjacent channel)
		58		dB	$\pm 25\text{ kHz}$ (alternate channel)
		78		dB	$\pm 1\text{ MHz}$
		82		dB	$\pm 2\text{ MHz}$
		86		dB	$\pm 10\text{ MHz}$
Blocking and Selectivity 1.2-kbps 2-GFSK, 25-kHz channel separation, 4-kHz deviation, 16-kHz channel filter $f_{\text{xosc}} = 40\text{ MHz}$ using TCXO Using external SAW filter for compliance with ETSI category 1		58		dB	$\pm 25\text{ kHz}$ (alternate channel)
		77		dB	$\pm 1\text{ MHz}$
		106		dB	$\pm 2\text{ MHz}$
		101		dB	$\pm 10\text{ MHz}$
		42		dB	$\pm 100\text{ kHz}$ (adjacent channel)
Blocking and Selectivity 38.4-kbps 2-GFSK, 100-kHz channel separation, 20-kHz deviation, 100- kHz channel filter		43		dB	$\pm 200\text{ kHz}$ (alternate channel)
		62		dB	$\pm 1\text{ MHz}$
		66		dB	$\pm 2\text{ MHz}$
		74		dB	$\pm 10\text{ MHz}$
		43		dB	$\pm 200\text{ kHz}$ (adjacent channel)
Blocking and Selectivity 50-kbps 2-GFSK, 200-kHz channel separation, 25-kHz deviation, 100- kHz channel filter (Same modulation format as 802.15.4g Mandatory Mode)		50		dB	$\pm 400\text{ kHz}$ (alternate channel)
		61		dB	$\pm 1\text{ MHz}$
		65		dB	$\pm 2\text{ MHz}$
		74		dB	$\pm 10\text{ MHz}$
		36		dB	$\pm 200\text{ kHz}$ (adjacent channel)
Blocking and Selectivity 200-kbps 4-GFSK, 83-kHz deviation (outer symbols), 200-kHz channel filter, zero IF		44		dB	$\pm 400\text{ kHz}$ (alternate channel)
		55		dB	$\pm 1\text{ MHz}$
		59		dB	$\pm 2\text{ MHz}$
		67		dB	$\pm 10\text{ MHz}$
	Image rejection (Image compensation enabled) $f_{\text{xosc}} = 40\text{ MHz}$ using TCXO		58		dB

(1) DEV is short for deviation, CHF is short for channel filter bandwidth

#### 4.10.4 RX Performance in 434-MHz Band (High-Performance Mode)

$T_A = 25^\circ\text{C}$ ,  $V_{DD} = 3.0\text{ V}$ ,  $f_{\text{xosc}} = 32\text{ MHz}$  if nothing else stated if nothing else stated

PARAMETER	MIN	TYP	MAX	UNIT	CONDITION
Sensitivity		-129		dBm	300 bps, DEV=1 kHz, CHF=3.8 kHz <sup>(1)</sup> $f_{\text{xosc}} = 40\text{ MHz}$
		-123		dBm	1.2 kbps, DEV=4 kHz CHF=10 kHz <sup>(1)</sup>
		-109		dBm	50-kbps 2-GFSK, DEV=25 kHz, CHF=100 kHz <sup>(1)</sup>
		-116		dBm	1.2 kbps, DEV=20 kHz CHF=50 kHz <sup>(1)</sup>
Blocking and Selectivity 0.3-kbps 2-FSK, 6.25-kHz channel separation, 1-kHz deviation, 3.8-kHz channel filter $f_{\text{xosc}} = 40\text{ MHz}$ using TCXO		65		dB	+ 6.25 kHz (adjacent channel)
		66		dB	+ 12.5 kHz (alternate channel)
		86		dB	$\pm 1\text{ MHz}$
		90		dB	$\pm 2\text{ MHz}$
		95		dB	$\pm 10\text{ MHz}$
Blocking and Selectivity 1.2-kbps 2-FSK, 12.5-kHz channel separation, 4-kHz deviation, 10-kHz channel filter $f_{\text{xosc}} = 40\text{ MHz}$ using TCXO		60		dB	+ 12.5 kHz (adjacent channel)
		61		dB	$\pm 25\text{ kHz}$ (alternate channel)
		80		dB	$\pm 1\text{ MHz}$
		85		dB	$\pm 2\text{ MHz}$
		91		dB	$\pm 10\text{ MHz}$
Blocking and Selectivity 38.4-kbps 2-GFSK, 100-kHz channel separation, 20-kHz deviation, 100-kHz channel filter		47		dB	+ 100 kHz (adjacent channel)
		50		dB	$\pm 200\text{ kHz}$ (alternate channel)
		67		dB	$\pm 1\text{ MHz}$
		71		dB	$\pm 2\text{ MHz}$
		78		dB	$\pm 10\text{ MHz}$

(1) DEV is short for deviation, CHF is short for channel filter bandwidth

#### 4.10.5 RX Performance in 169-MHz Band (High-Performance Mode)

 $T_A = 25^\circ\text{C}$ ,  $V_{DD} = 3.0\text{ V}$ ,  $f_{xosc} = 32\text{ MHz}$  if nothing else stated

PARAMETER	MIN	TYP	MAX	UNIT	CONDITION
Sensitivity		-129		dBm	300 bps, DEV=1 kHz, CHF=3.8 kHz <sup>(1)</sup> $f_{xosc} = 40\text{ MHz}$
		-123		dBm	1.2 kbps, DEV=4 kHz CHF=10 kHz <sup>(1)</sup>
Blocking and Selectivity 0.3-kbps 2-FSK, 6.25-kHz channel separation, 1-kHz deviation, 3.8-kHz channel filter $f_{xosc} = 40\text{ MHz}$ using TCXO		67		dB	$\pm 6.25\text{ kHz}$ (adjacent channel)
		67		dB	+ 12.5 kHz (alternate channel)
		88		dB	$\pm 1\text{ MHz}$
		101		dB	-2 MHz
		104		dB	$\pm 10\text{ MHz}$
Blocking and Selectivity 1.2-kbps 2-FSK, 12.5-kHz channel separation, 4-kHz deviation, 10-kHz channel filter $f_{xosc} = 40\text{ MHz}$ using TCXO		63		dB	$\pm 12.5\text{ kHz}$ (adjacent channel)
		65		dB	$\pm 25\text{ kHz}$ (alternate channel)
		82		dB	$\pm 1\text{ MHz}$
		86		dB	$\pm 2\text{ MHz}$
		93		dB	-10 MHz
Spurious Response Rejection 1.2-kbps 2-FSK, 12.5-kHz channel separation, 4-kHz deviation, 10-kHz channel filter		70		dB	
Image Rejection (Image compensation enabled)		66		dB	1.2 kbps, DEV=4 kHz CHF=10 kHz <sup>(1)</sup> , image at -125 kHz

(1) DEV is short for deviation, CHF is short for channel filter bandwidth

#### 4.10.6 RX Performance in Low-Power Mode

$T_A = 25^\circ\text{C}$ ,  $V_{DD} = 3.0\text{ V}$ ,  $f_c = 869.5\text{ MHz}$ ,  $f_{xosc} = 32\text{ MHz}$  if nothing else stated

PARAMETER	MIN	TYP	MAX	UNIT	CONDITION
Sensitivity		-111		dBm	1.2 kbps, DEV=4 kHz CHF=10 kHz <sup>(1)</sup>
		-99		dBm	38.4 kbps, DEV=50 kHz CHF=100 kHz <sup>(1)</sup>
		-99		dBm	50-kbps 2-GFSK, DEV=25 kHz, CHF=100 kHz <sup>(1)</sup>
Blocking and Selectivity 1.2-kbps 2-FSK, 12.5-kHz channel separation, 4-kHz deviation, 10-kHz channel filter		46		dB	± 12.5 kHz (adjacent channel)
		46		dB	± 25 kHz (alternate channel)
		73		dB	± 1 MHz
		78		dB	± 2 MHz
		79		dB	± 10 MHz
Blocking and Selectivity 1.2-kbps 2-FSK, 50-kHz channel separation, 20-kHz deviation, 50-kHz channel filter		43		dB	± 50 kHz (adjacent channel)
		45		dB	+ 100 kHz (alternate channel)
		71		dB	± 1 MHz
		74		dB	± 2 MHz
		75		dB	± 10 MHz
Blocking and Selectivity 38.4-kbps 2-GFSK, 100-kHz channel separation, 20-kHz deviation, 100-kHz channel filter		37		dB	+ 100 kHz (adjacent channel)
		43		dB	+ 200 kHz (alternate channel)
		58		dB	± 1 MHz
		62		dB	± 2 MHz
		64		dB	+ 10 MHz
Blocking and Selectivity 50-kbps 2-GFSK, 200-kHz channel separation, 25-kHz deviation, 100-kHz channel filter (Same modulation format as 802.15.4g Mandatory Mode)		43		dB	+ 200 kHz (adjacent channel)
		52		dB	+ 400 kHz (alternate channel)
		60		dB	± 1 MHz
		64		dB	± 2 MHz
		65		dB	± 10 MHz
Saturation		+10		dBm	

(1) DEV is short for deviation, CHF is short for channel filter bandwidth



## 4.11 Transmit Parameters

 $T_A = 25^\circ\text{C}$ ,  $V_{DD} = 3.0\text{ V}$ ,  $f_c = 869.5\text{ MHz}$ ,  $f_{\text{xosc}} = 32\text{ MHz}$  if nothing else stated

PARAMETER	MIN	TYP	MAX	UNIT	CONDITION
Max output power		+12		dBm	At 950 MHz
		+14		dBm	At 915- and 920-MHz
		+15		dBm	At 915- and 920-MHz with $V_{DD} = 3.6\text{ V}$
		+15		dBm	At 868 MHz
		+16		dBm	At 868 MHz with $V_{DD} = 3.6\text{ V}$
		+15		dBm	At 433 MHz
Min output power		-11		dBm	Within fine step size range
		-40		dBm	Within coarse step size range
Output power step size		0.4		dB	Within fine step size range
Adjacent channel power		-75		dBc	4-GFSK 9.6 kbps in 12.5-kHz channel, measured in 100-Hz bandwidth at 434 MHz (FCC Part 90 Mask D compliant)
		-58		dBc	4-GFSK 9.6 kbps in 12.5-kHz channel, measured in 8.75-kHz bandwidth (ETSI 300 220 compliant)
		-61		dBc	2-GFSK 2.4 kbps in 12.5-kHz channel, 1.2-kHz deviation
Spurious emissions (not including harmonics)		<-60		dBm	
Harmonics					Transmission at +14 dBm (or maximum allowed in applicable band where this is less than +14 dBm) using TI reference design. Emissions measured according to ARIB T-96 in 950-MHz band, ETSI EN 300-220 in 169-, 433-, and 868-MHz bands and FCC part 15.247 in 450- and 915-MHz band. Fourth harmonic in 915-MHz band will require extra filtering to meet FCC requirements if transmitting for long intervals (>50-ms periods).
Second Harm, 169 MHz		-39		dBm	
Third Harm, 169 MHz		-58		dBm	
Second Harm, 433 MHz		-56		dBm	
Third Harm, 433 MHz		-51		dBm	
Second Harm, 450 MHz		-60		dBm	
Third Harm, 450 MHz		-45		dBm	
Second Harm, 868 MHz		-40		dBm	
Third Harm, 868 MHz		-42		dBm	
Second Harm, 915 MHz		56		dBuV/m	
Third Harm, 915 MHz		52		dBuV/m	
Fourth Harm, 915 MHz		60		dBuV/m	
Second Harm, 950 MHz		-58		dBm	
Third Harm, 950 MHz		-42		dBm	
Optimum load					
Impedance 868-, 915-, and 920-MHz bands		35 + j35		$\Omega$	
433-MHz band		55 + j25		$\Omega$	
169-MHz band		80 + j0		$\Omega$	

## 4.12 PLL Parameters

### 4.12.1 High-Performance Mode

$T_A = 25^\circ\text{C}$ ,  $V_{DD} = 3.0\text{ V}$ ,  $f_c = 869.5\text{ MHz}$ ,  $f_{xosc} = 40\text{ MHz}$  using TCXO if nothing else stated

PARAMETER	MIN	TYP	MAX	UNIT	CONDITION
Phase noise in 950-MHz band $f_{xosc} = 32\text{ MHz}$		-100		dBc/Hz	$\pm 10\text{ kHz offset}$
		-103		dBc/Hz	$\pm 100\text{ kHz offset}$
		-123		dBc/Hz	$\pm 1\text{ MHz offset}$
Phase noise in 868-, 915-, 920-MHz bands		-101		dBc/Hz	$\pm 10\text{ kHz offset}$
		-102		dBc/Hz	$\pm 100\text{ kHz offset}$
		-124		dBc/Hz	$\pm 1\text{ MHz offset}$
Phase noise in 433-MHz band		-107		dBc/Hz	$\pm 10\text{ kHz offset}$
		-110		dBc/Hz	$\pm 100\text{ kHz offset}$
		-130		dBc/Hz	$\pm 1\text{ MHz offset}$
Phase noise in 169-MHz band		-115		dBc/Hz	$\pm 10\text{ kHz offset}$
		-115		dBc/Hz	$\pm 100\text{ kHz offset}$
		-135		dBc/Hz	$\pm 1\text{ MHz offset}$

### 4.12.2 Low-Power Mode

$T_A = 25^\circ\text{C}$ ,  $V_{DD} = 3.0\text{ V}$ ,  $f_c = 869.5\text{ MHz}$ ,  $f_{xosc} = 32\text{ MHz}$  if nothing else stated

PARAMETER	MIN	TYP	MAX	UNIT	CONDITION
Phase noise in 950-MHz band		-90		dBc/Hz	$\pm 10\text{ kHz offset}$
		-92		dBc/Hz	$\pm 100\text{ kHz offset}$
		-124		dBc/Hz	$\pm 1\text{ MHz offset}$
Phase noise in 868-, 915-, and 920-MHz bands		-95		dBc/Hz	$\pm 10\text{ kHz offset}$
		-95		dBc/Hz	$\pm 100\text{ kHz offset}$
		-124		dBc/Hz	$\pm 1\text{ MHz offset}$
Phase noise in 433-MHz band		-98		dBc/Hz	$\pm 10\text{ kHz offset}$
		-102		dBc/Hz	$\pm 100\text{ kHz offset}$
		-129		dBc/Hz	$\pm 1\text{ MHz offset}$
Phase noise in 169-MHz band		-106		dBc/Hz	$\pm 10\text{ kHz offset}$
		-110		dBc/Hz	$\pm 100\text{ kHz offset}$
		-136		dBc/Hz	$\pm 1\text{ MHz offset}$

### 4.13 Wake-up and Timing

 $T_A = 25^\circ\text{C}$ ,  $V_{DD} = 3.0\text{ V}$ ,  $f_c = 869.5\text{ MHz}$ ,  $f_{\text{XOSC}} = 32\text{ MHz}$  if nothing else stated

PARAMETER	MIN	TYP	MAX	UNIT	CONDITION
Powerdown to IDLE		0.4		ms	Depends on crystal
IDLE to RX/TX		166		$\mu\text{s}$	Calibration disabled
		461		$\mu\text{s}$	Calibration enabled
RX/TX turnaround		50		$\mu\text{s}$	
RX/TX to IDLE time		296		$\mu\text{s}$	Calibrate when leaving RX/TX enabled
		0		$\mu\text{s}$	Calibrate when leaving RX/TX disabled
Frequency synthesizer calibration		391		$\mu\text{s}$	When using SCAL strobe
Minimum required number of preamble bytes		0.5		bytes	Required for RF front-end gain settling only. Digital demodulation does not require preamble for settling.
Time from start RX until valid RSSI, including gain settling (function of channel bandwidth. Programmable for trade-off between speed and accuracy)		4.6		ms	12.5-kHz channels
		0.3		ms	200-kHz channels

### 4.14 High-Speed Crystal Oscillator

 $T_A = 25^\circ\text{C}$ ,  $V_{DD} = 3.0\text{ V}$  if nothing else stated

PARAMETER	MIN	TYP	MAX	UNIT	CONDITION
Crystal frequency	32		44	MHz	It is expected that there will be degraded sensitivity at multiples of XOSC/2 in RX, and an increase in spurious emissions when the RF channel is close to multiples of XOSC in TX. We recommend that the RF channel is kept RX_BW/2 away from XOSC/2 in RX, and that the level of spurious emissions be evaluated if the RF channel is closer than 1 MHz to multiples of XOSC in TX.
Load capacitance ( $C_L$ )		10		pF	
ESR		<50		$\Omega$	
Start-up time		0.4		ms	Depends on crystal

### 4.15 High-Speed Clock Input (TCXO)

 $T_A = 25^\circ\text{C}$ ,  $V_{DD} = 3.0\text{ V}$  if nothing else stated

PARAMETER	MIN	TYP	MAX	UNIT	CONDITION
Clock frequency	32		44	MHz	
TCXO with CMOS output					TCXO with CMOS output directly coupled to pin EXT_OSC
High input voltage	1.4		VDD	V	
Low input voltage	0		0.6	V	
Rise / Fall time			2	ns	
Clipped sine output					TCXO clipped sine output connected to pin EXT_OSC through series capacitor
Clock input amplitude (peak-to-peak)	0.8		1.5	V	

### 4.16 32-kHz Clock Input

 $T_A = 25^\circ\text{C}$ ,  $V_{DD} = 3.0\text{ V}$  if nothing else stated

PARAMETER	MIN	TYP	MAX	UNIT	CONDITION
Clock frequency		32		kHz	
32-kHz clock input pin input high voltage	0.8xVDD			V	
32-kHz clock input pin input low voltage			0.2xVDD	V	

#### 4.17 Low Speed RC Oscillator

$T_A = 25^\circ\text{C}$ ,  $V_{DD} = 3.0\text{ V}$  if nothing else stated

PARAMETER	MIN	TYP	MAX	UNIT	CONDITION
Frequency		32/40		kHz	After calibration (calibrated against the high-speed XOSC)
Frequency accuracy after calibration		$\pm 0.1$		%	Relative to frequency reference (for example, 32-MHz crystal or TCXO)
Initial calibration time		1.6		ms	

#### 4.18 I/O and Reset

$T_A = 25^\circ\text{C}$ ,  $V_{DD} = 3.0\text{ V}$  if nothing else stated

PARAMETER	MIN	TYP	MAX	UNIT	CONDITION
Logic input high voltage	$0.8 \times V_{DD}$			V	
Logic input low voltage			$0.2 \times V_{DD}$	V	
Logic output high voltage	$0.8 \times V_{DD}$			V	At 4-mA output load or less
Logic output low voltage			$0.2 \times V_{DD}$	V	
Power-on reset threshold		1.3		V	Voltage on DVDD pin

#### 4.19 Temperature Sensor

$T_A = 25^\circ\text{C}$ ,  $V_{DD} = 3.0\text{ V}$  if nothing else stated

PARAMETER	MIN	TYP	MAX	UNIT	CONDITION
Temperature sensor range	-40		85	$^\circ\text{C}$	
Temperature coefficient		2.66		$\text{mV} / ^\circ\text{C}$	Change in sensor output voltage versus change in temperature
Typical output voltage		794		mV	Typical sensor output voltage at $T_A = 25^\circ\text{C}$ , $V_{DD} = 3.0\text{ V}$
VDD coefficient		1.17		$\text{mV} / \text{V}$	Change in sensor output voltage versus change in VDD

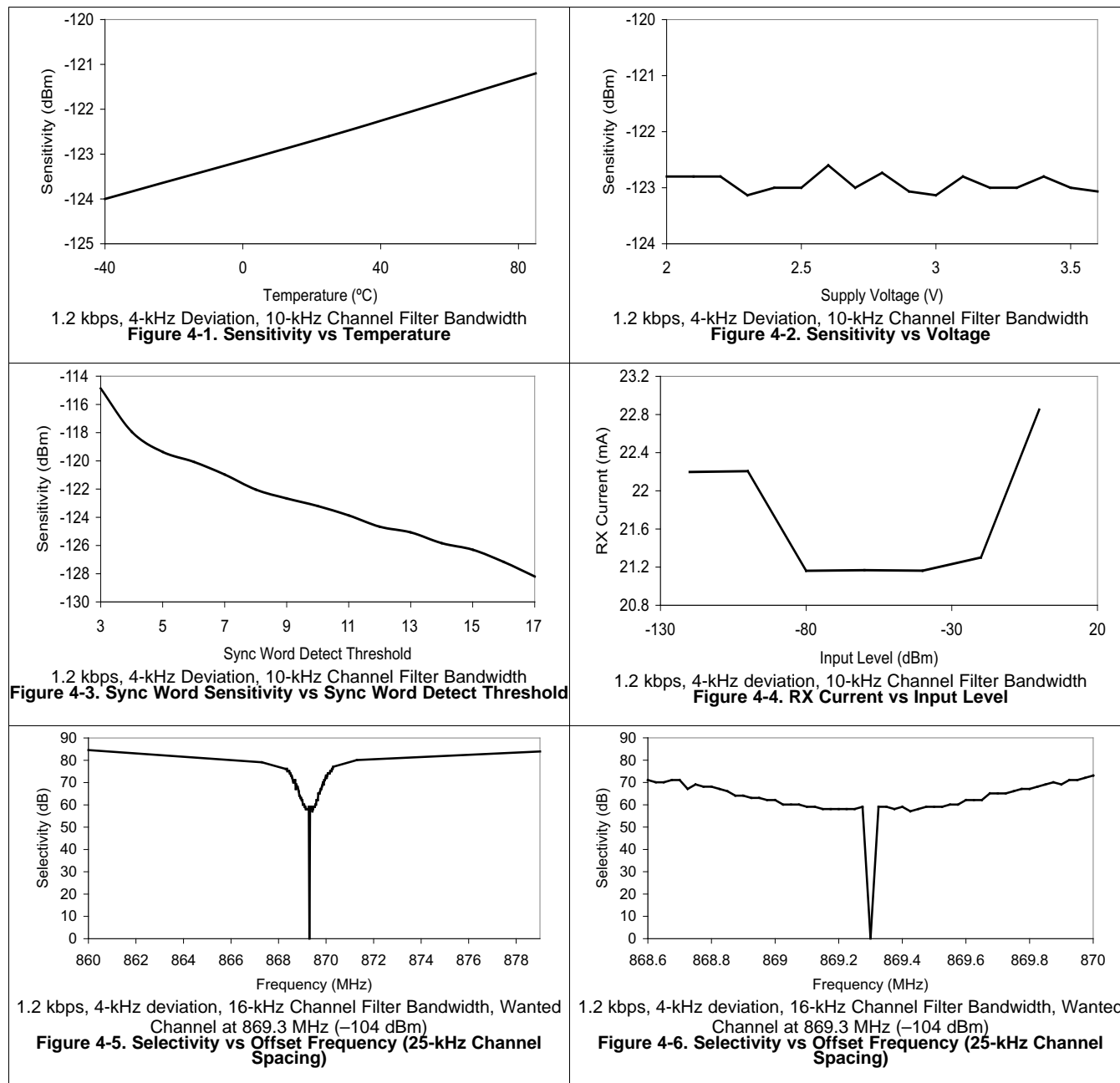
The CC1125 device can be configured to provide a voltage proportional to temperature on GPIO1. The temperature can be estimated by measuring this voltage (see [Section 4.19, Temperature Sensor](#)). For more information, see the temperature sensor design note ([SWRA415](#)).

## 4.20 Typical Characteristics

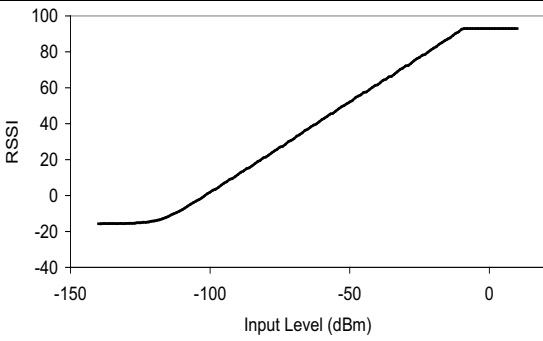
$T_A = 25^\circ\text{C}$ ,  $V_{DD} = 3.0\text{ V}$ ,  $f_c = 869.5\text{ MHz}$  if nothing else stated.

All measurements performed on CC1120EM\_868\_915 rev.1.0.1, CC1120EM\_955 rev.1.2.1, CC1120EM\_420\_470 rev.1.0.1 or CC1120EM\_169 rev.1.2 ( $f_{\text{xosc}} = 32\text{ MHz}$ ), and CC1125EM\_868\_915 rev.1.1.0, CC1125EM\_420\_470 rev.1.1.0, CC1125EM\_169 rev.1.1.0, CC1125EM-Cat1-868 ( $f_{\text{xosc}} = 40\text{ MHz}$ ).

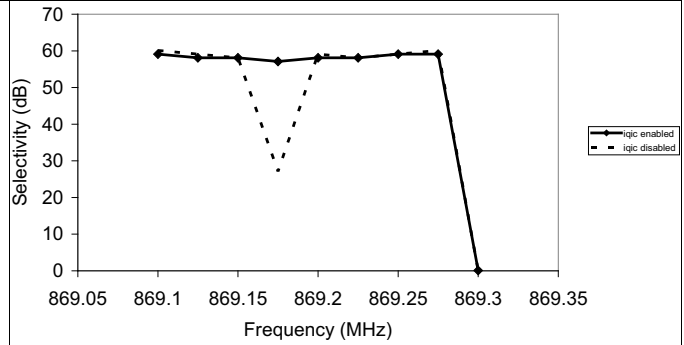
Figure 4-16 was measured at the 50- $\Omega$  antenna connector.



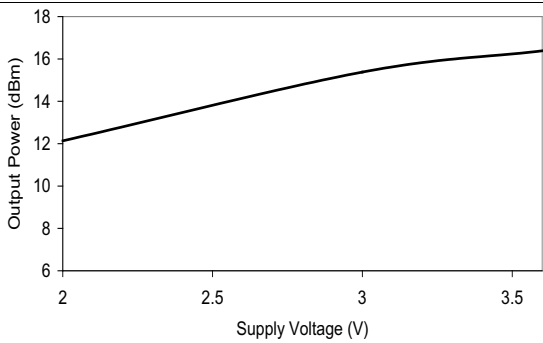
**Typical Characteristics (continued)**



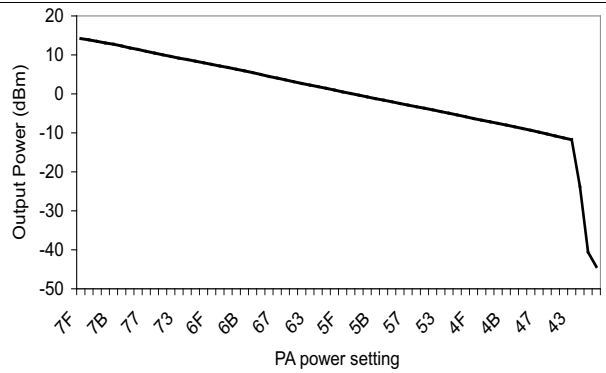
**Figure 4-7. RSSI vs Input Level**



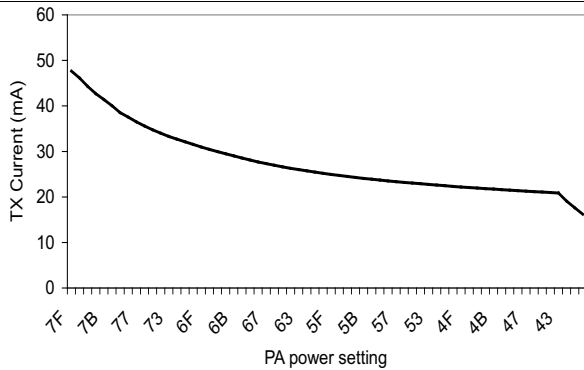
**Figure 4-8. Automatic Image Cancellation**



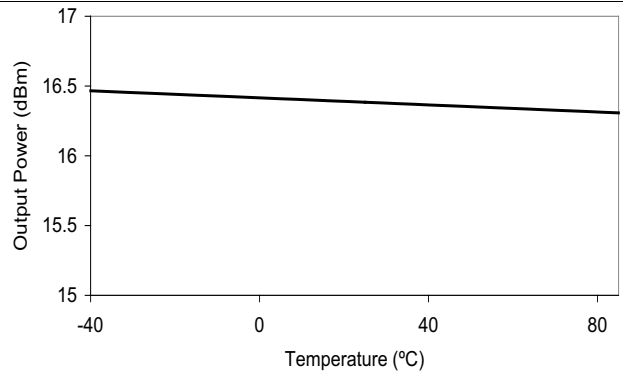
**Figure 4-9. Output Power vs Voltage  
Max Setting, 170 MHz**



**Figure 4-10. Output Power at 868 MHz  
vs PA Power Setting**

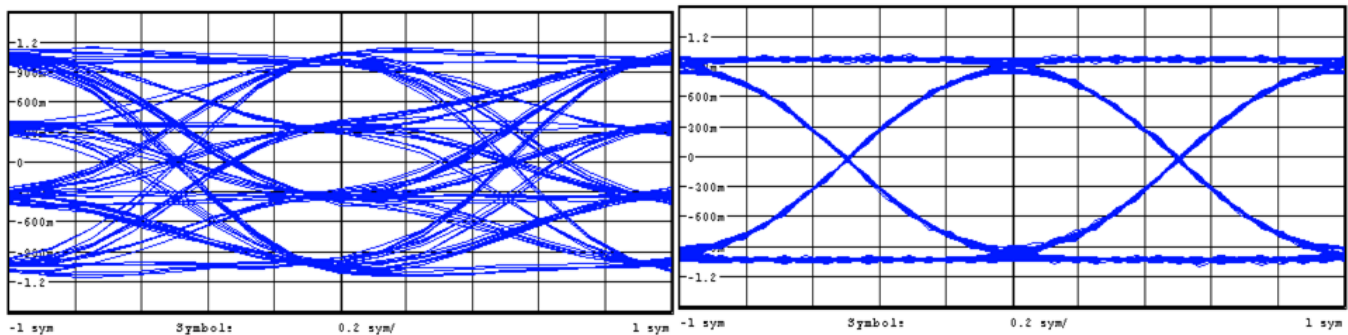


**Figure 4-11. TX Current at 868 MHz  
vs PA Power Setting**



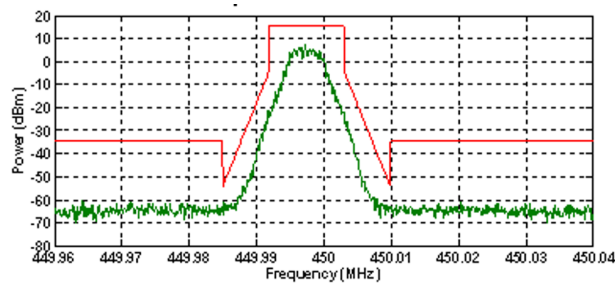
**Figure 4-12. Output Power vs Temperature  
Max Setting, 170 MHz, 3.6 V**

Typical Characteristics (continued)



200 kbps, DEV = 83 kHz (Outer Symbols), 4GFSK  
Figure 4-13. Eye Diagram

1.2 kbps 2-FSK, DEV = 4 kHz  
Figure 4-14. Eye Diagram



9.6 kbps in 12.5 kHz Channel  
Figure 4-15. FCC Part 90 Mask D

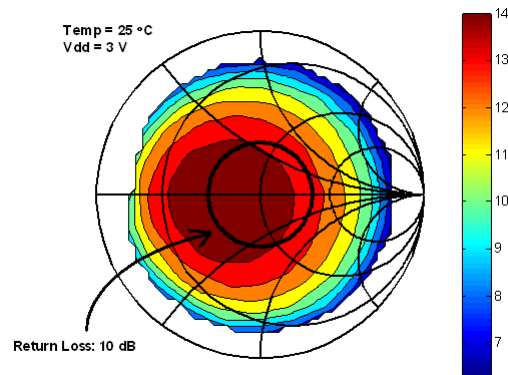


Figure 4-16. Output Power vs Load Impedance (+14-dBm Setting)

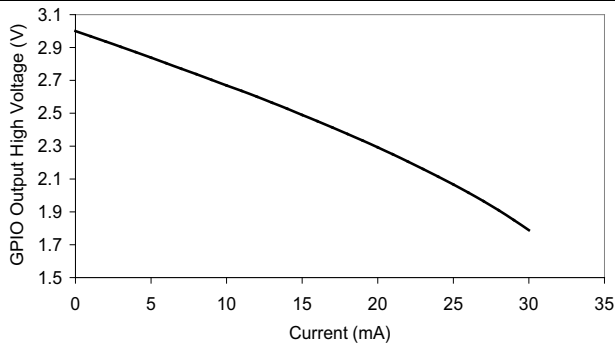


Figure 4-17. GPIO Output High Voltage vs Current Being Sourced

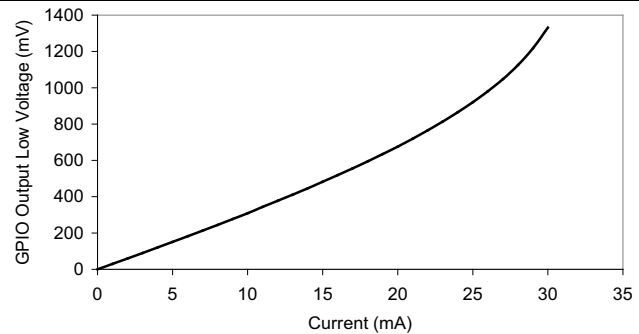


Figure 4-18. GPIO Output Low Voltage vs Current Being Sunk

## 5 Detailed Description

### 5.1 Block Diagram

Figure 5-1 shows the system block diagram of the CC1125 device.

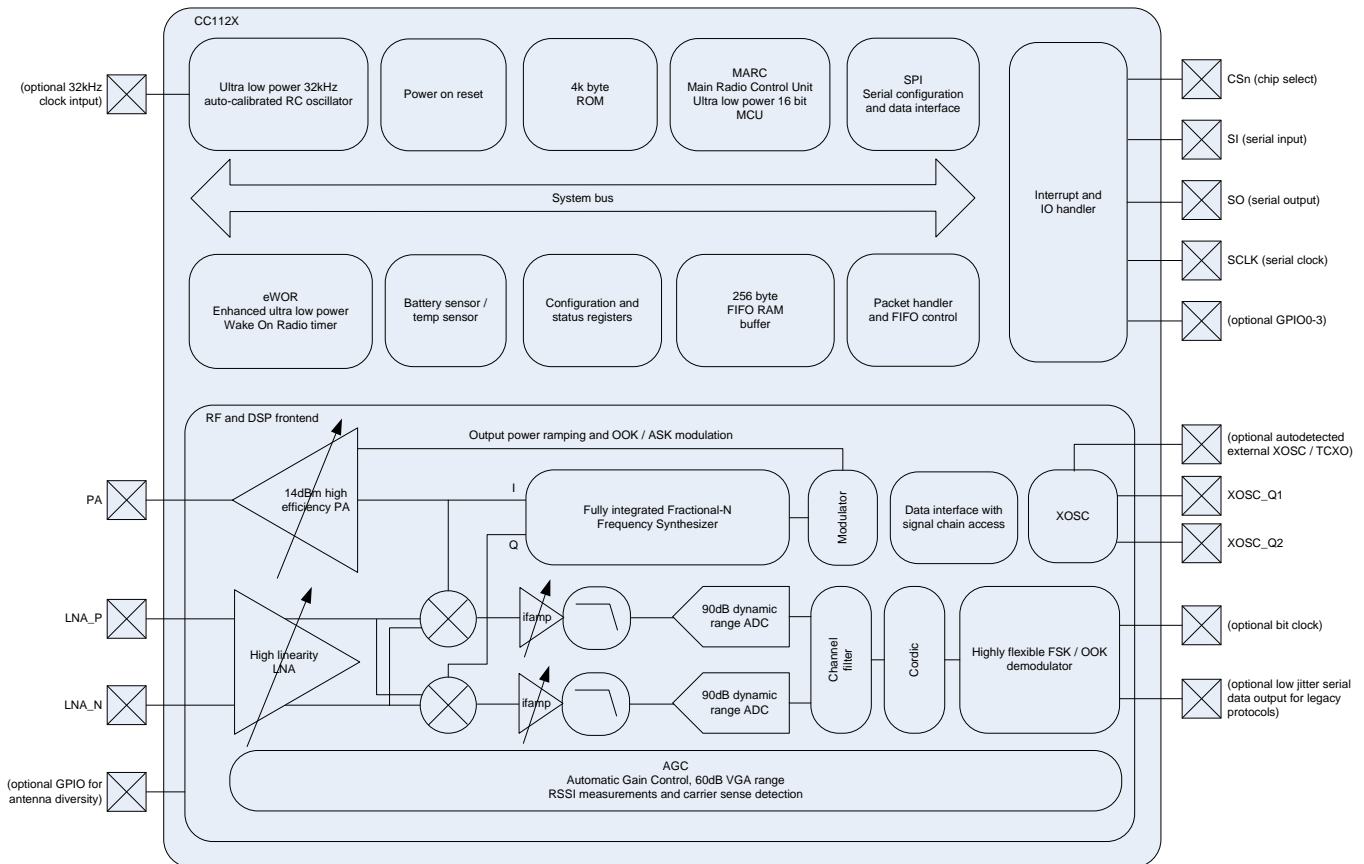


Figure 5-1. System Block Diagram

### 5.2 Frequency Synthesizer

At the center of the CC1125 device there is a fully integrated, fractional-N, ultra-high-performance frequency synthesizer. The frequency synthesizer is designed for excellent phase noise performance, providing very high selectivity and blocking performance. The system is designed to comply with the most stringent regulatory spectral masks at maximum transmit power.

Either a crystal can be connected to XOSC\_Q1 and XOSC\_Q2, or a TCXO can be connected to the EXT\_XOSC input. The oscillator generates the reference frequency for the synthesizer, as well as clocks for the analog-to-digital converter (ADC) and the digital part. To reduce system cost, CC1125 device has high-accuracy frequency estimation and compensation registers to measure and compensate for crystal inaccuracies. This compensation enables the use of lower cost crystals. If a TCXO is used, the CC1125 device automatically turns on and off the TCXO when needed to support low-power modes and Wake-On-Radio operation.



### 5.3 Receiver

The CC1125 device features a highly flexible receiver. The received RF signal is amplified by the low-noise amplifier (LNA) and is down-converted in quadrature (I/Q) to the intermediate frequency (IF). At IF, the I/Q signals are digitized by the high dynamic-range ADCs.

An advanced automatic gain control (AGC) unit adjusts the front-end gain, and enables the CC1125 device to receive strong and weak signals, even in the presence of strong interferers. High-attenuation channels and data filtering enable reception with strong neighbor channel interferers. The I/Q signal is converted to a phase and magnitude signal to support the FSK and OOK modulation schemes.

---

#### NOTE

A unique I/Q compensation algorithm removes any problem of I/Q mismatch, thus avoiding time-consuming and costly I/Q image calibration steps.

---

### 5.4 Transmitter

The CC1125 transmitter is based on direct synthesis of the RF frequency (in-loop modulation). To use the spectrum effectively, the CC1125 device has extensive data filtering and shaping in TX mode to support high throughput data communication in narrowband channels. The modulator also controls power ramping to remove issues such as spectral splattering when driving external high-power RF amplifiers.

### 5.5 Radio Control and User Interface

The CC1125 digital control system is built around the main radio control (MARC), which is implemented using an internal high-performance, 16-bit ultra-low-power processor. MARC handles power modes, radio sequencing, and protocol timing.

A 4-wire SPI serial interface is used for configuration and data buffer access. The digital baseband includes support for channel configuration, packet handling, and data buffering. The host MCU can stay in power-down mode until a valid RF packet is received. This greatly reduces power consumption. When the host MCU receives a valid RF packet, it burst-reads the data. This reduces the required computing power.

The CC1125 radio control and user interface are based on the widely used CC1101 transceiver. This relationship enables an easy transition between the two platforms. The command strobes and the main radio states are the same for the two platforms.

For legacy formats, the CC1125 device also supports two serial modes.

- Synchronous serial mode: The CC1125 device performs bit synchronization and provides the MCU with a bit clock with associated data.
- Transparent mode: The CC1125 device outputs the digital baseband signal using a digital interpolation filter to eliminate jitter introduced by digital filtering and demodulation.

### 5.6 4.5 Enhanced Wake-On-Radio (eWOR)

eWOR, using a flexible integrated sleep timer, enables automatic receiver polling with no intervention from the MCU. When the CC1125 device enters RX mode, it listens and then returns to sleep if a valid RF packet is not received. The sleep interval and duty cycle can be configured to make a trade-off between network latency and power consumption. Incoming messages are time-stamped to simplify timer re-synchronization.

The eWOR timer runs off an ultra-low-power 32-kHz RC oscillator. To improve timing accuracy, the RC oscillator can be automatically calibrated to the RF crystal in configurable intervals.

## 5.7 Sniff Mode

The CC1125 device supports quick start up times, and requires few preamble bits. Sniff mode uses these conditions to dramatically reduce the current consumption while the receiver is waiting for data.

Because the CC1125 device can wake up and settle much faster than the duration of most preambles, it is not required to be in RX mode continuously while waiting for a packet to arrive. Instead, the enhanced Wake-On-Radio feature can be used to put the device into sleep mode periodically. By setting an appropriate sleep time, the CC1125 device can wake up and receive the packet when it arrives with no performance loss. This sequence removes the need for accurate timing synchronization between transmitter and receiver, and lets the user trade off current consumption between the transmitter and receiver.

For more information, see the sniff mode design note ([SWRA428](#)).

## 5.8 Antenna Diversity

Antenna diversity can increase performance in a multipath environment. An external antenna switch is required. The CC1201 device uses one of the GPIO pins to automatically control the switch. This device also supports differential output control signals typically used in RF switches.

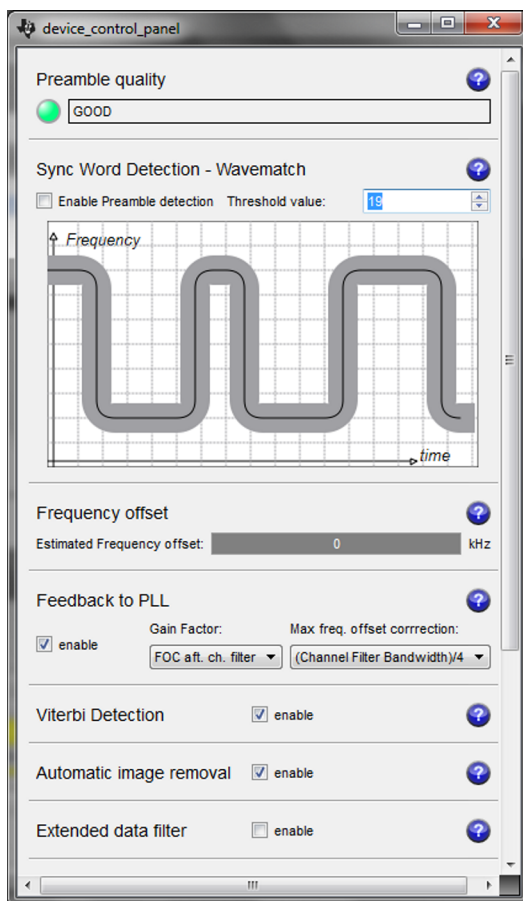
If antenna diversity is enabled, the GPIO alternates between high and low states until a valid RF input signal is detected. An optional acknowledge packet can be transmitted without changing the state of the GPIO.

An incoming RF signal can be validated by received signal strength or by using the automatic preamble detector. Using the automatic preamble detector ensures a more robust system and avoids the need to set a defined signal strength threshold (such a threshold sets the sensitivity limit of the system).

## 5.9 WaveMatch

Advanced capture logic locks onto the synchronization word and does not require preamble settling bytes. Therefore, receiver settling time is reduced to the settling time of the AGC, typically 4 bits.

The WaveMatch feature also greatly reduces false sync triggering on noise, further reducing the power consumption and improving sensitivity and reliability. The same logic can also be used as a high-performance preamble detector to reliably detect a valid preamble in the channel.



See [SWRC046](#) for more information.

**Figure 5-2. Receiver Configurator in SmartRF™ Studio**

## 6 Typical Application Circuit

### NOTE

This section is intended only as an introduction.

Very few external components are required for the operation of the CC1125 device. Figure 6-1 shows a typical application circuit. The board layout will greatly influence the RF performance of the CC1125 device. Figure 6-1 does not show decoupling capacitors for power pins.

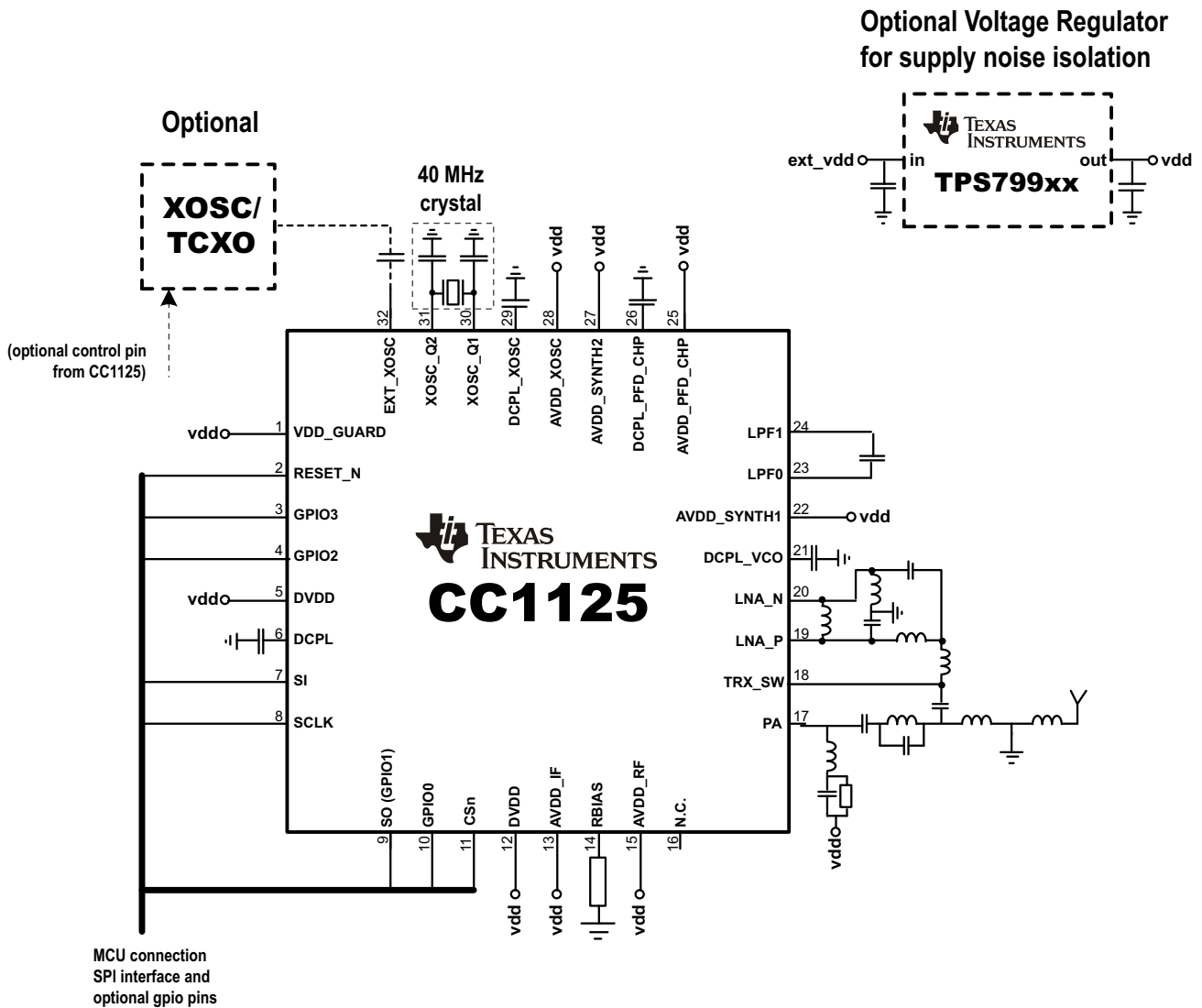


Figure 6-1. Typical Application Circuit

For more information, see the reference designs available for the CC1125 device in [节 7.2, Documentation Support](#).

## 7 器件和文档支持

### 7.1 器件支持

#### 7.1.1 开发支持

##### 7.1.1.1 配置软件

CC1125 器件可使用 SmartRF Studio 软件 ([SWRC046](#)) 进行配置。强烈建议使用 SmartRF Studio 软件来获取最优寄存器设置并评估相关性能和功能。

#### 7.1.2 器件和支持开发工具命名规则

为了指出产品开发周期所处的阶段，TI 为所有微处理器 (MPU) 和支持工具的产品型号分配了前缀。每个器件都具有以下三个前缀中的一个：X、P 或无（无前缀）（例如，CC1125）。德州仪器 (TI) 建议为其支持的工具使用三个可用前缀指示符中的两个：TMDX 和 TMDS。这些前缀代表了产品开发的发展阶段，即从工程原型 (TMDX) 直到完全合格的生产器件和工具 (TMDS)。

器件开发进化流程：

- X**            试验器件不一定代表最终器件的电气规范标准并且不可使用生产组装流程。
- P**            原型器件不一定是最终芯片模型并且不一定符合最终电气标准规范。
- 无            完全合格的芯片模型的生产版本。

支持工具开发发展流程：

- TMDX**        还未经德州仪器 (TI) 完整内部质量测试的开发支持产品。
- TMDS**        完全合格的开发支持产品。

X 和 P 器件和 TMDX 开发支持工具在供货时附带如下免责条款：

“开发的产品用于内部评估用途。”

生产器件和 TMDS 开发支持工具已进行完全特性描述，并且器件的质量和可靠性已经完全论证。TI 的标准保修证书适用。

预测显示原型器件 (X 或者 P) 的故障率大于标准生产器件。由于它们的预计的最终使用故障率仍未定义，德州仪器 (TI) 建议不要将这些器件用于任何生产系统。只有合格的产品器件将被使用。

TI 器件的命名规则也包括一个带有器件系列名称的后缀。这个后缀表示封装类型（例如，RHB），温度范围（例如，“空白”是默认的商业级温度范围）以及器件速度范围（以 MHz 为单位），并且提供了读取任一 CC1125 器件完整器件名称的图例。

要获得 QFN 封装类型的 CC1125 器件订购部件号，请参见本文档的“封装选项附录”（TI 网站 [www.ti.com](http://www.ti.com)），或者联系您的 TI 销售代表。

## 7.2 文档支持

以下文档对 CC1125 处理器加以补充。 [www.ti.com](http://www.ti.com) 网站上提供了这些文档的副本。 提示：请在 [www.ti.com](http://www.ti.com) 上提供的搜索框中输入文献编号。

- [SWRR106](#) CC112x IPC 868MHz 和 915MHz 2 层参考设计
- [SWRR107](#) CC112x IPC 868MHz 和 915MHz 4 层参考设计
- [SWRR100](#) CC1125EM 169MHz 参考设计
- [SWRR101](#) CC1125EM 420MHz 至 470MHz 参考设计
- [SWRR102](#) CC1121EM 868MHz 至 915MHz 参考设计
- [SWRR097](#) CC1120EM CAT1 868MHz 参考设计
- [SWRC046](#) SmartRF Studio 软件
- [SWRA428](#) CC112x/CC120x 嗅探模式应用手册

## 7.3 社区资源

下列链接提供到 TI 社区资源的连接。链接的内容由各个分销商“按照原样”提供。这些内容并不构成 TI 技术规范 and 标准且不一定反映 TI 的观点；请见 TI 的 [使用条款](#)。

[TI E2E™ 在线社区](#) [TI 工程师对工程师 \(E2E\) 社区](#)。此社区的创建目的是为了促进工程师之间协作。在 [e2e.ti.com](http://e2e.ti.com) 中，您可以咨询问题、共享知识、探索思路，在同领域工程师的帮助下解决问题。

[德州仪器 \(TI\) 嵌入式处理器维基网站](#) [德州仪器 \(TI\) 嵌入式处理器维基网站](#)。此网站的建立是为了帮助开发人员从德州仪器 (TI) 的嵌入式处理器入门并且也为了促进与这些器件相关的硬件和软件的总体知识的创新和增长。

## 7.4 商标

SmartRF, E2E are trademarks of Texas Instruments.

## 7.5 静电放电警告



ESD 可能会损坏该集成电路。德州仪器 (TI) 建议通过适当的预防措施处理所有集成电路。如果不遵守正确的处理措施和安装程序，可能会损坏集成电路。

ESD 的损坏小至导致微小的性能降级，大至整个器件故障。精密的集成电路可能更容易受到损坏，这是因为非常细微的参数更改都可能会导致器件与其发布的规格不相符。

## 7.6 术语表

[SLYZ022](#) — TI 术语表。

这份术语表列出并解释术语、首字母缩略词和定义。

## 8 机械封装和可订购信息

以下页中包括机械封装和可订购信息。 这些信息是针对指定器件可提供的最新数据。 这些数据会在无通知且不对本文档进行修订的情况下发生改变。 欲获得该数据表的浏览器版本，请查阅左侧的导航栏。

**PACKAGING INFORMATION**

Orderable Device	Status (1)	Package Type	Package Drawing	Pins	Package Qty	Eco Plan (2)	Lead finish/ Ball material (6)	MSL Peak Temp (3)	Op Temp (°C)	Device Marking (4/5)	Samples
CC1125RHBR	ACTIVE	VQFN	RHB	32	3000	RoHS & Green	NIPDAU   NIPDAUAG	Level-3-260C-168 HR	-40 to 85	CC1125	<a href="#">Samples</a>
CC1125RHBT	ACTIVE	VQFN	RHB	32	250	RoHS & Green	NIPDAU   NIPDAUAG	Level-3-260C-168 HR	-40 to 85	CC1125	<a href="#">Samples</a>

(1) The marketing status values are defined as follows:

**ACTIVE:** Product device recommended for new designs.

**LIFEBUY:** TI has announced that the device will be discontinued, and a lifetime-buy period is in effect.

**NRND:** Not recommended for new designs. Device is in production to support existing customers, but TI does not recommend using this part in a new design.

**PREVIEW:** Device has been announced but is not in production. Samples may or may not be available.

**OBSELETE:** TI has discontinued the production of the device.

(2) **RoHS:** TI defines "RoHS" to mean semiconductor products that are compliant with the current EU RoHS requirements for all 10 RoHS substances, including the requirement that RoHS substance do not exceed 0.1% by weight in homogeneous materials. Where designed to be soldered at high temperatures, "RoHS" products are suitable for use in specified lead-free processes. TI may reference these types of products as "Pb-Free".

**RoHS Exempt:** TI defines "RoHS Exempt" to mean products that contain lead but are compliant with EU RoHS pursuant to a specific EU RoHS exemption.

**Green:** TI defines "Green" to mean the content of Chlorine (Cl) and Bromine (Br) based flame retardants meet JS709B low halogen requirements of <=1000ppm threshold. Antimony trioxide based flame retardants must also meet the <=1000ppm threshold requirement.

(3) MSL, Peak Temp. - The Moisture Sensitivity Level rating according to the JEDEC industry standard classifications, and peak solder temperature.

(4) There may be additional marking, which relates to the logo, the lot trace code information, or the environmental category on the device.

(5) Multiple Device Markings will be inside parentheses. Only one Device Marking contained in parentheses and separated by a "~" will appear on a device. If a line is indented then it is a continuation of the previous line and the two combined represent the entire Device Marking for that device.

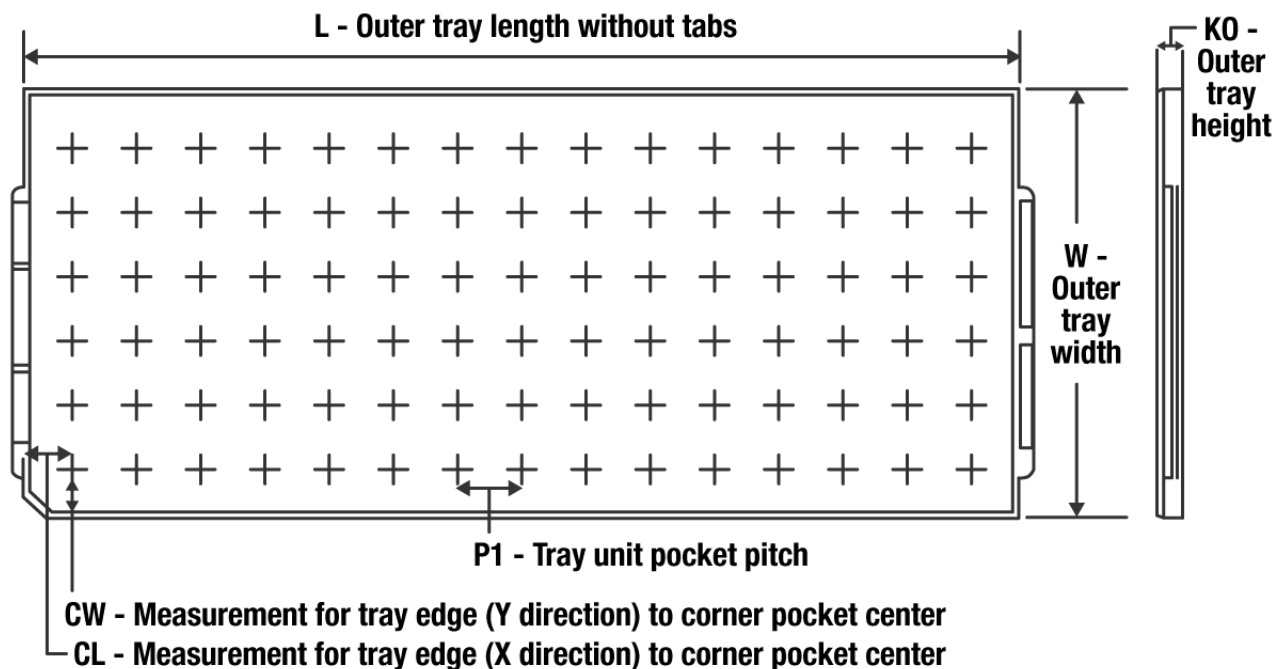
(6) Lead finish/Ball material - Orderable Devices may have multiple material finish options. Finish options are separated by a vertical ruled line. Lead finish/Ball material values may wrap to two lines if the finish value exceeds the maximum column width.

**Important Information and Disclaimer:**The information provided on this page represents TI's knowledge and belief as of the date that it is provided. TI bases its knowledge and belief on information provided by third parties, and makes no representation or warranty as to the accuracy of such information. Efforts are underway to better integrate information from third parties. TI has taken and continues to take reasonable steps to provide representative and accurate information but may not have conducted destructive testing or chemical analysis on incoming materials and chemicals. TI and TI suppliers consider certain information to be proprietary, and thus CAS numbers and other limited information may not be available for release.

In no event shall TI's liability arising out of such information exceed the total purchase price of the TI part(s) at issue in this document sold by TI to Customer on an annual basis.





**TRAY**


Chamfer on Tray corner indicates Pin 1 orientation of packed units.

\*All dimensions are nominal

Device	Package Name	Package Type	Pins	SPQ	Unit array matrix	Max temperature (°C)	L (mm)	W (mm)	K0 (µm)	P1 (mm)	CL (mm)	CW (mm)
CC1125RHBR	RHB	VQFN	32	3000	14 x 35	150	315	135.9	7620	8.8	7.9	8.15
CC1125RHBR	RHB	VQFN	32	3000	14 x 35	150	315	135.9	7620	8.8	7.9	8.15
CC1125RHBT	RHB	VQFN	32	250	14 x 35	150	315	135.9	7620	8.8	7.9	8.15
CC1125RHBT	RHB	VQFN	32	250	14 x 35	150	315	135.9	7620	8.8	7.9	8.15

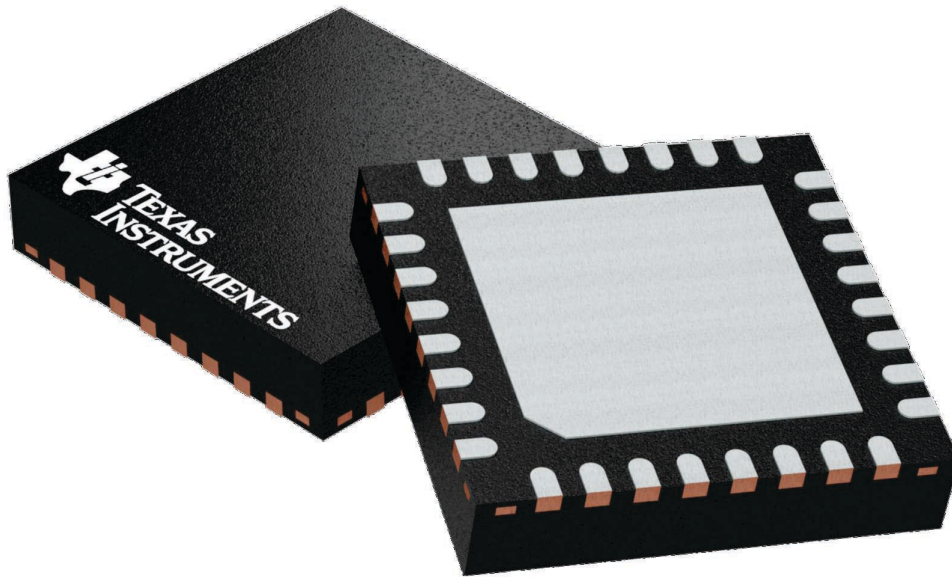
## GENERIC PACKAGE VIEW

**RHB 32**

**VQFN - 1 mm max height**

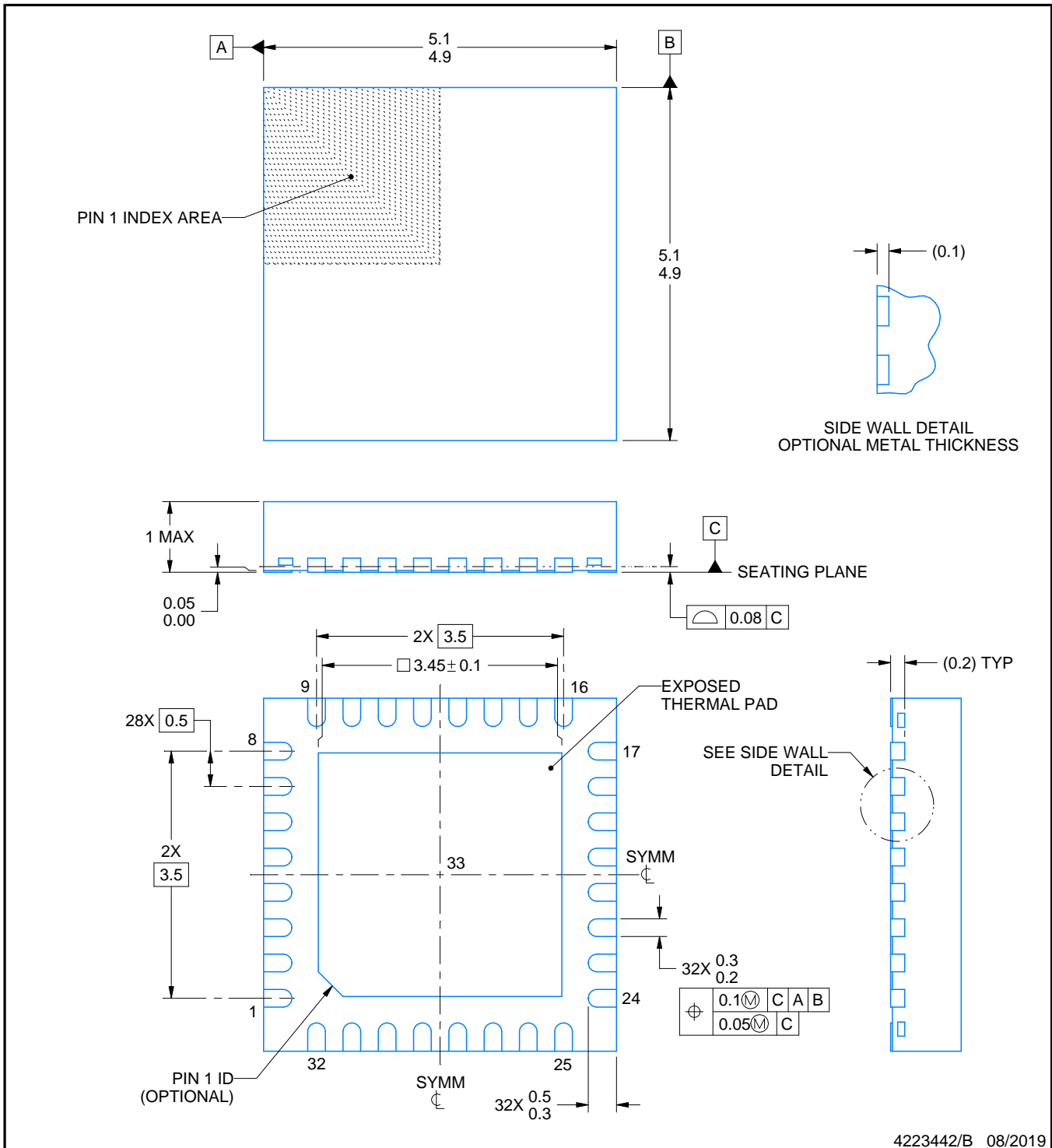
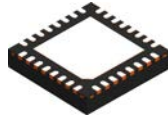
5 x 5, 0.5 mm pitch

PLASTIC QUAD FLATPACK - NO LEAD



Images above are just a representation of the package family, actual package may vary.  
Refer to the product data sheet for package details.

4224745/A



4223442/B 08/2019

NOTES:

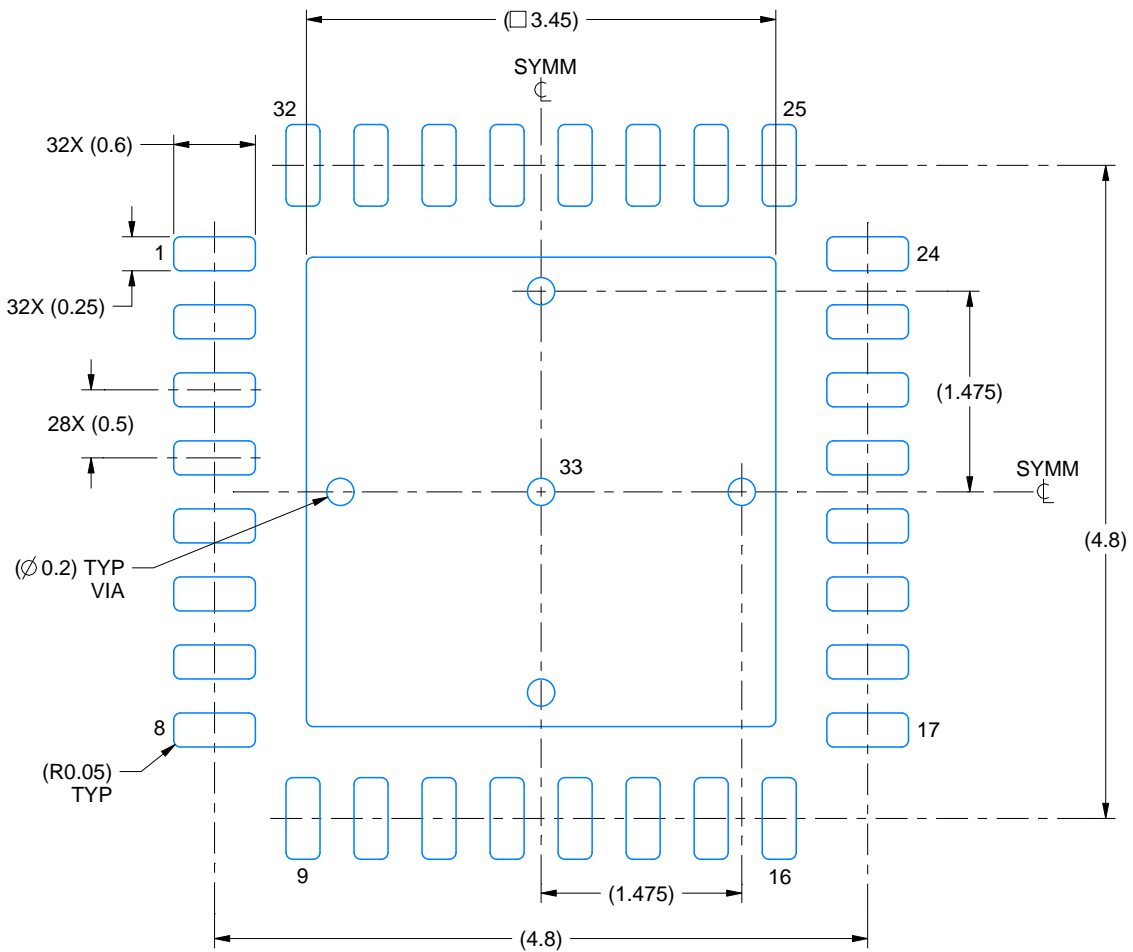
1. All linear dimensions are in millimeters. Any dimensions in parenthesis are for reference only. Dimensioning and tolerancing per ASME Y14.5M.
2. This drawing is subject to change without notice.
3. The package thermal pad must be soldered to the printed circuit board for thermal and mechanical performance.

# EXAMPLE BOARD LAYOUT

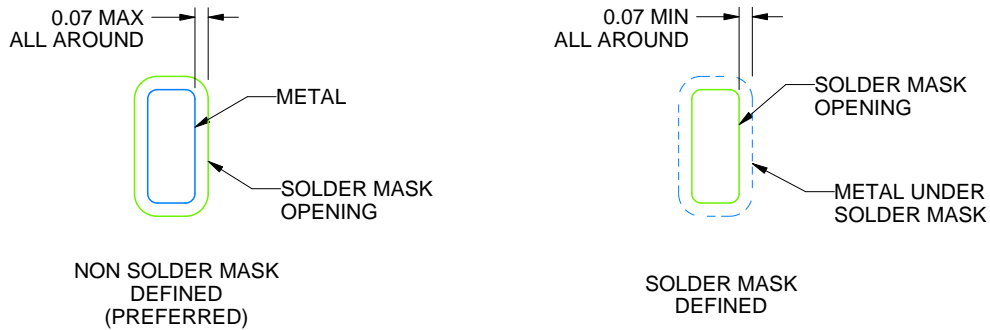
RHB0032E

VQFN - 1 mm max height

PLASTIC QUAD FLATPACK - NO LEAD



LAND PATTERN EXAMPLE  
SCALE:18X



SOLDER MASK DETAILS

4223442/B 08/2019

NOTES: (continued)

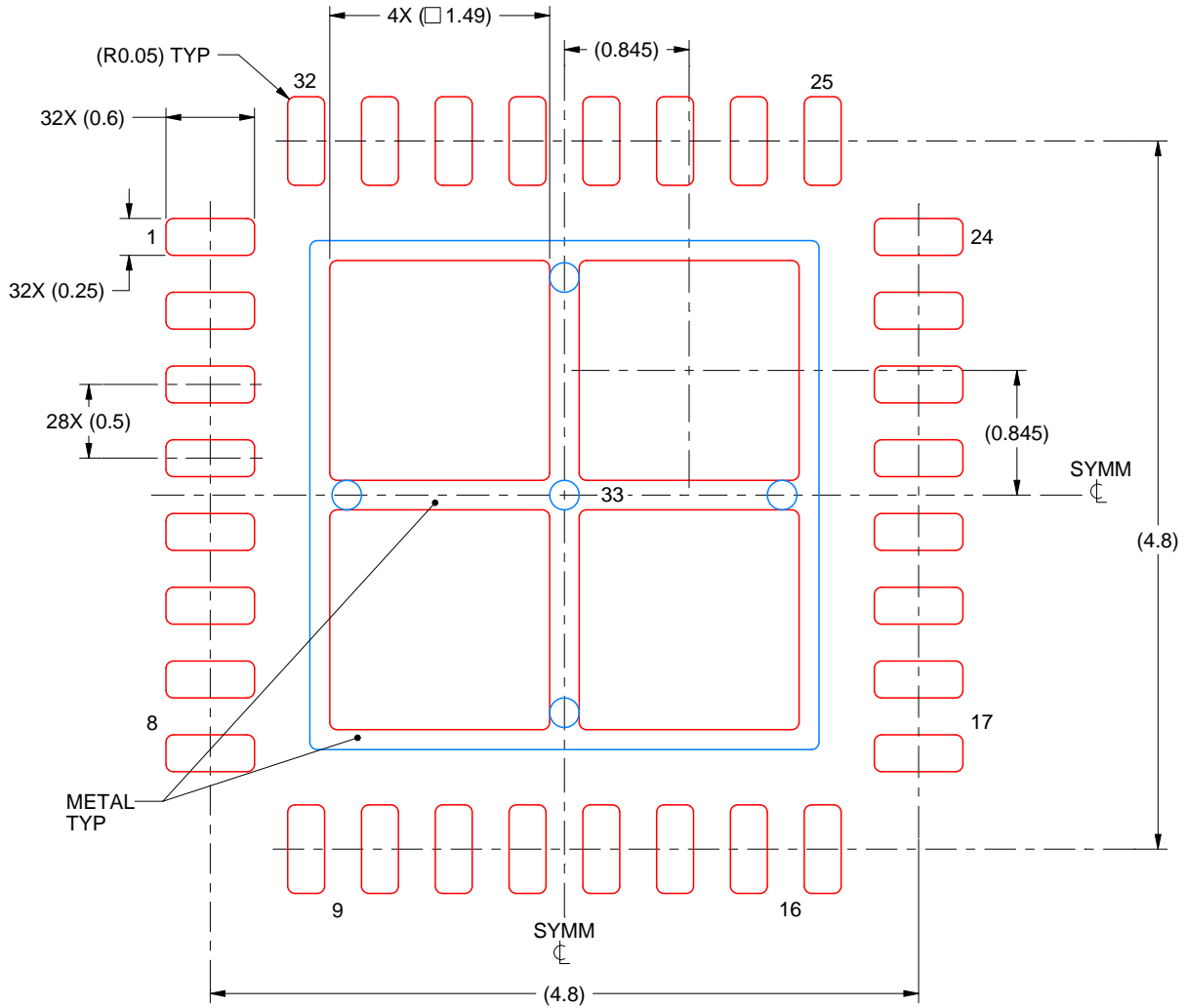
4. This package is designed to be soldered to a thermal pad on the board. For more information, see Texas Instruments literature number SLUA271 ([www.ti.com/lit/slua271](http://www.ti.com/lit/slua271)).
5. Vias are optional depending on application, refer to device data sheet. If any vias are implemented, refer to their locations shown on this view. It is recommended that vias under paste be filled, plugged or tented.

# EXAMPLE STENCIL DESIGN

RHB0032E

VQFN - 1 mm max height

PLASTIC QUAD FLATPACK - NO LEAD



**SOLDER PASTE EXAMPLE**  
 BASED ON 0.125 mm THICK STENCIL

EXPOSED PAD 33:  
 75% PRINTED SOLDER COVERAGE BY AREA UNDER PACKAGE  
 SCALE:20X

4223442/B 08/2019

NOTES: (continued)

6. Laser cutting apertures with trapezoidal walls and rounded corners may offer better paste release. IPC-7525 may have alternate design recommendations.

## 重要声明和免责声明

TI“按原样”提供技术和可靠性数据（包括数据表）、设计资源（包括参考设计）、应用或其他设计建议、网络工具、安全信息和其他资源，不保证没有瑕疵且不做任何明示或暗示的担保，包括但不限于对适销性、某特定用途方面的适用性或不侵犯任何第三方知识产权的暗示担保。

这些资源可供使用 TI 产品进行设计的熟练开发人员使用。您将自行承担以下全部责任：(1) 针对您的应用选择合适的 TI 产品，(2) 设计、验证并测试您的应用，(3) 确保您的应用满足相应标准以及任何其他功能安全、信息安全、监管或其他要求。

这些资源如有变更，恕不另行通知。TI 授权您仅可将这些资源用于研发本资源所述的 TI 产品的应用。严禁对这些资源进行其他复制或展示。您无权使用任何其他 TI 知识产权或任何第三方知识产权。您应全额赔偿因在这些资源的使用中对 TI 及其代表造成的任何索赔、损害、成本、损失和债务，TI 对此概不负责。

TI 提供的产品受 [TI 的销售条款](#) 或 [ti.com](#) 上其他适用条款/TI 产品随附的其他适用条款的约束。TI 提供这些资源并不会扩展或以其他方式更改 TI 针对 TI 产品发布的适用的担保或担保免责声明。

TI 反对并拒绝您可能提出的任何其他或不同的条款。

邮寄地址：Texas Instruments, Post Office Box 655303, Dallas, Texas 75265

Copyright © 2022，德州仪器 (TI) 公司

单击下面可查看定价，库存，交付和生命周期等信息

[>>TI\(德州仪器\)](#)