

## TPS7B81-Q1 150-mA, Off-Battery, Ultra-Low- $I_Q$ (3- $\mu$ A), Low-Dropout Regulator

### 1 Features

- AEC-Q100 qualified for automotive applications:
  - Temperature grade 1:  $-40^{\circ}\text{C}$  to  $125^{\circ}\text{C}$ ,  $T_A$
- Device junction temperature range:  $-40^{\circ}\text{C}$  to  $150^{\circ}\text{C}$
- 3-V to 40-V wide  $V_{IN}$  input voltage range with up to 45-V transient
- Maximum output current: 150 mA
- Low quiescent current  $I_Q$ :
  - 300 nA typical when EN = low (shutdown mode)
  - 2.7  $\mu\text{A}$  typical at light loads
  - 4.5  $\mu\text{A}$  maximum at light loads
- 1.5% output-voltage accuracy over line, load and temperature
- Maximum dropout voltage: 540 mV at 150-mA load current for fixed 5-V output version
- Stable with low-ESR (0.001- $\Omega$  to 5- $\Omega$ ) ceramic output-stability capacitor (1  $\mu\text{F}$  to 200  $\mu\text{F}$ )
- Fixed 5-V, 3.3-V and 2.5-V output voltage
- Integrated fault protection:
  - Thermal shutdown
  - Short-circuit and overcurrent protection
- Packages:
  - DGN (8-pin HVSSOP),  $R_{\theta JA} = 63.9^{\circ}\text{C/W}$
  - DRV (6-pin WSON),  $R_{\theta JA} = 72.8^{\circ}\text{C/W}$
  - KVU (5-pin TO-252),  $R_{\theta JA} = 38.8^{\circ}\text{C/W}$

### 2 Applications

- [Automotive head units](#)
- [Headlights](#)
- [Battery management systems \(BMS\)](#)
- [Inverter and motor controls](#)

### 3 Description

In automotive battery-connected applications, low quiescent current ( $I_Q$ ) is important to conserve energy and to extend battery lifetime. Always-on systems must have ultralow  $I_Q$  over an extended temperature range to enable sustained operation when the vehicle ignition is off.

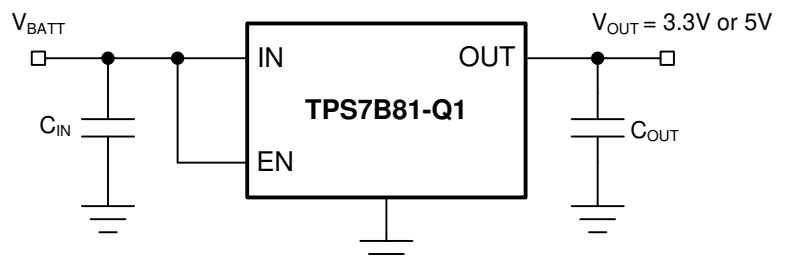
The TPS7B81-Q1 is a low-dropout (LDO) linear regulator designed for up to 40-V  $V_{IN}$  applications. With only a 2.7- $\mu\text{A}$  typical quiescent current at light load, the device is an optimal solution for powering microcontrollers and controller area network and local interconnect network (CAN/LIN) transceivers in standby systems.

The device features integrated short-circuit and overcurrent protection. This device operates in ambient temperatures from  $-40^{\circ}\text{C}$  to  $+125^{\circ}\text{C}$  and with junction temperatures from  $-40^{\circ}\text{C}$  to  $+150^{\circ}\text{C}$ . Additionally, this device is available in several packages of varying size and thermal conductivity. The small WSON package facilitates the most compact PCB design and the TO-252 package enables sustained operation despite significant dissipation across the device. These features make the device well suited as a power supply for various battery-connected automotive applications.

#### Device Information

PART NUMBER (1)	PACKAGE	BODY SIZE (NOM)
TPS7B81-Q1	HVSSOP (8)	3.00 mm $\times$ 3.00 mm
	WSON (6)	2.00 mm $\times$ 2.00 mm
	TO-252 (5)	6.10 mm $\times$ 6.60 mm

(1) For all available packages, see the orderable addendum at the end of the data sheet.



Typical Application Schematic



An IMPORTANT NOTICE at the end of this data sheet addresses availability, warranty, changes, use in safety-critical applications, intellectual property matters and other important disclaimers. PRODUCTION DATA.

## Table of Contents

<b>1 Features</b> .....	1	7.4 Device Functional Modes.....	13
<b>2 Applications</b> .....	1	<b>8 Application and Implementation</b> .....	14
<b>3 Description</b> .....	1	8.1 Application Information.....	14
<b>4 Revision History</b> .....	2	8.2 Typical Application.....	18
<b>5 Pin Configuration and Functions</b> .....	3	<b>9 Power Supply Recommendations</b> .....	19
Pin Functions.....	4	<b>10 Layout</b> .....	20
<b>6 Specifications</b> .....	5	10.1 Layout Guidelines.....	20
6.1 Absolute Maximum Ratings.....	5	10.2 Layout Example.....	20
6.2 ESD Ratings.....	5	<b>11 Device and Documentation Support</b> .....	21
6.3 Recommended Operating Conditions.....	5	11.1 Receiving Notification of Documentation Updates..	21
6.4 Thermal Information.....	5	11.2 Support Resources.....	21
6.5 Electrical Characteristics.....	6	11.3 Trademarks.....	21
6.6 Typical Characteristics.....	8	11.4 Electrostatic Discharge Caution.....	21
<b>7 Detailed Description</b> .....	12	11.5 Glossary.....	21
7.1 Overview.....	12	<b>12 Mechanical, Packaging, and Orderable</b>	
7.2 Functional Block Diagram.....	12	<b>Information</b> .....	21
7.3 Feature Description.....	12		

## 4 Revision History

NOTE: Page numbers for previous revisions may differ from page numbers in the current version.

### Changes from Revision C (April 2020) to Revision D (June 2020) Page

- Changed the numbering format for tables, figures, and cross-references throughout the document..... 1
- Added footnote and deleted  $V_{OUT} = 2.5\text{ V}$  rows from *Dropout voltage* parameter..... 6

### Changes from Revision B (August 2019) to Revision C (April 2020) Page

- Changed KVVU package from preview to production data..... 1
- Changed *Applications* section ..... 1

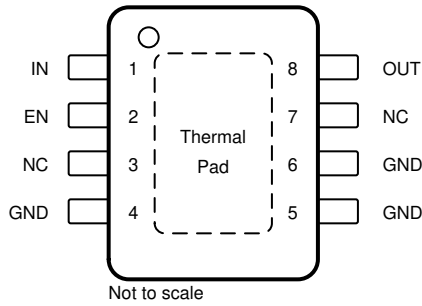
### Changes from Revision A (June 2019) to Revision B (August 2019) Page

- Changed DGN package from preview to production data ..... 1
- Changed *525 mV* to *540 mV* in *Maximum dropout voltage* Features bullet..... 1
- Added  $R_{\theta JA}$  versus *Cu Area for the HVSSOP (DGN) Package* through  $\psi_{JB}$  versus *Cu Area for the TO-252 (KVVU) Package* figures to *Power Dissipation* section..... 14
- Deleted values from capacitors  $C_{IN}$  and  $C_{OUT}$  in [Figure 8-7](#) ..... 18

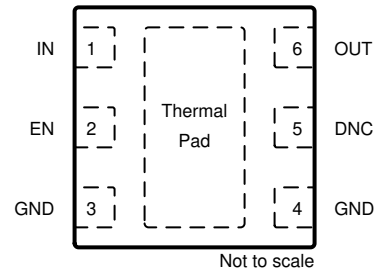
### Changes from Revision \* (May 2019) to Revision A (June 2019) Page

- Changed Advance Information to Production Data ..... 1

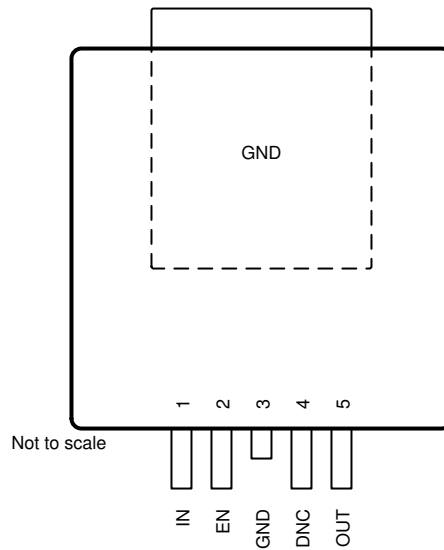
## 5 Pin Configuration and Functions



**Figure 5-1. DGN Package, 8-Pin HVSSOP PowerPAD™, Top View**



**Figure 5-2. DRV Package, 6-Pin WSON PowerPAD™, Top View**



**Figure 5-3. KVU Package, 5-Pin TO-252, Top View**

## Pin Functions

NAME	PIN			I/O	DESCRIPTION
	NO.				
	DGN	DRV	KVU		
DNC	—	5	4	—	Do not connect to a biased voltage. Tie this pin to ground or leave floating.
EN	2	2	2	I	Enable input pin. Drive EN greater than $V_{IH}$ to turn on the regulator. Drive EN less than $V_{IL}$ to put the low-dropout (LDO) into shutdown mode.
GND	4, 5, 6	3,4	3, TAB	—	Ground reference
IN	1	1	1	I	Input power-supply pin. For best transient response and to minimize input impedance, use the recommended value or larger ceramic capacitor from IN to ground as listed in the <a href="#">Recommended Operating Conditions</a> table and the <a href="#">Input Capacitor</a> section. Place the input capacitor as close to the output of the device as possible.
NC	3, 7	—	—	—	Not internally connected
OUT	8	6	5	O	Regulated output voltage pin. A capacitor is required from OUT to ground for stability. For best transient response, use the nominal recommended value or larger ceramic capacitor from OUT to ground; see the <a href="#">Recommended Operating Conditions</a> table and the <a href="#">Output Capacitor</a> section. Place the output capacitor as close to output of the device as possible.
Thermal pad				—	Connect the thermal pad to a large-area GND plane for improved thermal performance.

## 6 Specifications

### 6.1 Absolute Maximum Ratings

over operating ambient temperature range (unless otherwise noted)<sup>(1) (2)</sup>

		MIN	MAX	UNIT
V <sub>IN</sub>	Unregulated input <sup>(3)</sup>	-0.3	45	V
V <sub>EN</sub>	Enable input <sup>(3)</sup>	-0.3	V <sub>IN</sub>	V
V <sub>OUT</sub>	Regulated output	-0.3	7	V
T <sub>J</sub>	Junction temperature range	-40	150	°C
T <sub>stg</sub>	Storage temperature range	-40	150	°C

- (1) Stresses beyond those listed under *Absolute Maximum Ratings* may cause permanent damage to the device. These are stress ratings only, which do not imply functional operation of the device at these or any other conditions beyond those indicated under *Recommended Operating Conditions*. Exposure to absolute-maximum-rated conditions for extended periods may affect device reliability.
- (2) All voltage values are with respect to GND.
- (3) Absolute maximum voltage, can withstand 45 V for 200 ms.

### 6.2 ESD Ratings

			VALUE	UNIT	
V <sub>(ESD)</sub>	Electrostatic discharge	Human-body model (HBM), per AEC Q100-002 <sup>(1)</sup>	±2000	V	
		Charged-device model (CDM), per AEC Q100-011	Corner pins		±750
			Other pins		±500

- (1) AEC Q100-002 indicates that HBM stressing shall be in accordance with the ANSI/ESDA/JEDEC JS-001 specification.

### 6.3 Recommended Operating Conditions

over operating ambient temperature range (unless otherwise noted)

		MIN	MAX	UNIT
V <sub>IN</sub>	Unregulated input voltage	3	40	V
V <sub>EN</sub>	Enable input voltage	0	V <sub>IN</sub>	V
C <sub>OUT</sub>	Output capacitor requirements <sup>(1)</sup>	1	200	μF
ESR	Output capacitor ESR requirements <sup>(2)</sup>	0.001	5	Ω
T <sub>A</sub>	Ambient temperature range	-40	125	°C
T <sub>J</sub>	Junction temperature range	-40	150	°C

- (1) The output capacitance range specified in the table is the effective value.
- (2) Relevant ESR value at f = 10 kHz

### 6.4 Thermal Information

THERMAL METRIC <sup>(1)</sup>		TPS7B81-Q1			UNIT
		DGN (HVSSOP)	DRV (WSON)	KVU (TO-252)	
		8 PINS	6 PINS	5 PINS	
R <sub>θJA</sub>	Junction-to-ambient thermal resistance	63.9	72.8	31.1	°C/W
R <sub>θJC(top)</sub>	Junction-to-case (top) thermal resistance	50.2	85.8	39.9	°C/W
R <sub>θJB</sub>	Junction-to-board thermal resistance	22.6	37.4	9.9	°C/W
ψ <sub>JT</sub>	Junction-to-top characterization parameter	1.8	2.7	4.2	°C/W
ψ <sub>JB</sub>	Junction-to-board characterization parameter	22.3	37.3	9.9	°C/W

**TPS7B81-Q1**

SBVS370D – MAY 2019 – REVISED JUNE 2020

THERMAL METRIC <sup>(1)</sup>		TPS7B81-Q1			UNIT
		DGN (HVSSOP)	DRV (WSON)	KVU (TO-252)	
		8 PINS	6 PINS	5 PINS	
R <sub>θJC(bot)</sub>	Junction-to-case (bottom) thermal resistance	12.1	13.8	2.8	°C/W

(1) For more information about traditional and new thermal metrics, see the [Semiconductor and IC Package Thermal Metrics application report](#).

## 6.5 Electrical Characteristics

over operating ambient temperature range, T<sub>J</sub> = –40°C to +150°C, V<sub>IN</sub> = 14 V, and 10-μF ceramic output capacitor (unless otherwise noted)

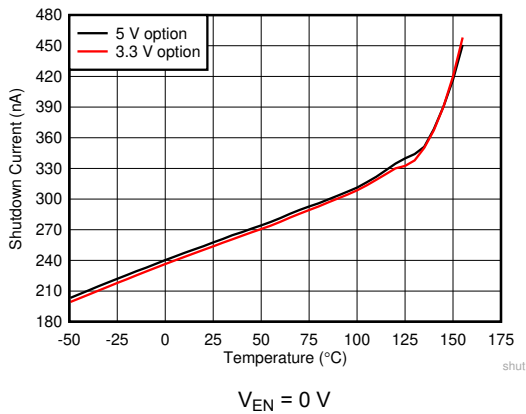
PARAMETER		TEST CONDITIONS		MIN	TYP	MAX	UNIT
<b>SUPPLY VOLTAGE AND CURRENT (IN)</b>							
V <sub>IN</sub>	Input voltage			V <sub>OUT(Nom)</sub> + V <sub>(Dropout)</sub>		40	V
I <sub>(SD)</sub>	Shutdown current	EN = 0 V		0.3	1		μA
I <sub>(Q)</sub>	Quiescent current	V <sub>IN</sub> = 6 V to 40 V, EN ≥ 2 V, I <sub>OUT</sub> = 0 mA		1.9	3.5		μA
		V <sub>IN</sub> = 6 V to 40 V, EN ≥ 2 V, I <sub>OUT</sub> = 0.2 mA	DGN package	2.7	6.5		
			DRV and KVU packages	2.7	4.5		
V <sub>(IN, UVLO)</sub>	V <sub>IN</sub> undervoltage detection	Ramp V <sub>IN</sub> down until the output turns off				2.7	V
		Hysteresis				200	mV
<b>ENABLE INPUT (EN)</b>							
V <sub>IL</sub>	Logic-input low level					0.7	V
V <sub>IH</sub>	Logic-input high level			2			V
I <sub>EN</sub>	Enable current			10			nA
<b>REGULATED OUTPUT (OUT)</b>							
V <sub>OUT</sub>	Regulated output	V <sub>IN</sub> = V <sub>OUT</sub> + V <sub>(Dropout)</sub> to 40 V, I <sub>OUT</sub> = 1 mA to 150 mA		–1.5%	1.5%		
V <sub>(Line-Reg)</sub>	Line regulation	V <sub>IN</sub> = 6 V to 40 V, I <sub>OUT</sub> = 10 mA				10	mV
V <sub>(Load-Reg)</sub>	Load regulation	V <sub>IN</sub> = 14 V, I <sub>OUT</sub> = 1 mA to 150 mA		DGN package		20	mV
				DRV and KVU packages		10	
V <sub>(Dropout)</sub>	Dropout voltage <sup>(1)</sup>	V <sub>OUT</sub> = 5 V	I <sub>OUT</sub> = 150 mA	DGN package		270	540
				DRV and KVU packages		325	585
			I <sub>OUT</sub> = 100 mA	DGN package		180	350
		DRV and KVU packages		200	390		
		V <sub>OUT</sub> = 3.3 V	I <sub>OUT</sub> = 150 mA	DGN package		650	
				DRV and KVU packages		345	675
		I <sub>OUT</sub> = 100 mA		255		450	
I <sub>OUT</sub>	Output current	V <sub>OUT</sub> in regulation, V <sub>IN</sub> = 7 V for the fixed 5-V option, V <sub>IN</sub> = 5.8 V for the fixed 3.3-V option		0	150		mA
I <sub>(CL)</sub>	Output current limit	V <sub>OUT</sub> short to 90% × V <sub>OUT</sub>		180	510	690	mA
PSRR	Power-supply ripple rejection	V <sub>(Ripple)</sub> = 0.5 V <sub>PP</sub> , I <sub>OUT</sub> = 10 mA, frequency = 100 Hz, C <sub>OUT</sub> = 2.2 μF		60			dB
<b>OPERATING TEMPERATURE RANGE</b>							

PARAMETER		TEST CONDITIONS	MIN	TYP	MAX	UNIT
$T_{(SD)}$	Junction shutdown temperature			175		°C
$T_{(HYST)}$	Hysteresis of thermal shutdown			20		°C

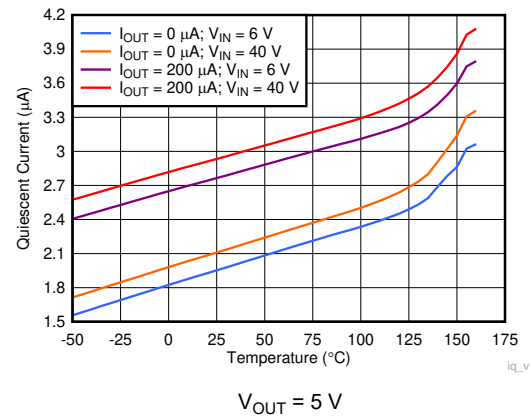
(1) Dropout is not valid for the 2.5-V output because of the minimum input voltage limits.

## 6.6 Typical Characteristics

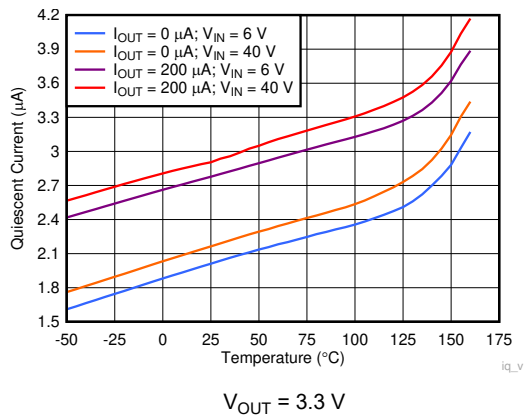
at  $T_J = -40^\circ\text{C}$  to  $+150^\circ\text{C}$ ,  $V_{IN} = 14\text{ V}$ , and  $V_{EN} \geq 2\text{ V}$  (unless otherwise noted)



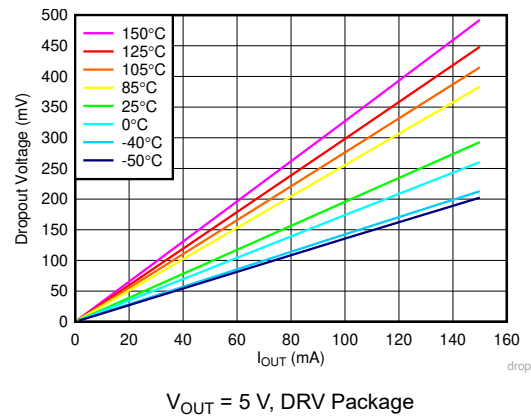
**Figure 6-1. Shutdown Current vs Ambient Temperature**



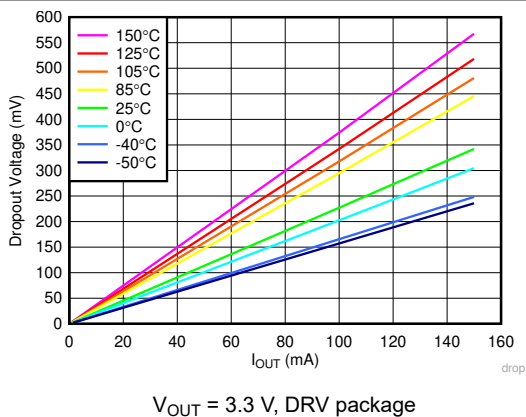
**Figure 6-2. Quiescent Current vs Ambient Temperature**



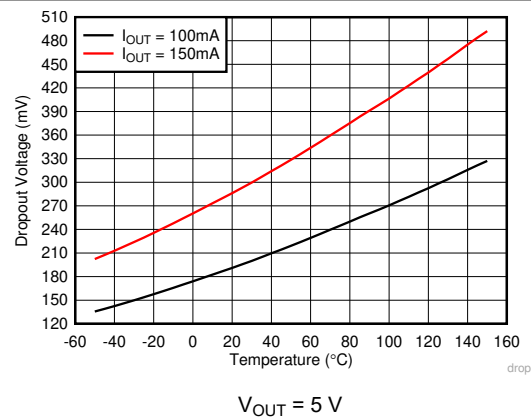
**Figure 6-3. Quiescent Current vs Ambient Temperature**



**Figure 6-4. Dropout Voltage vs Output Current**

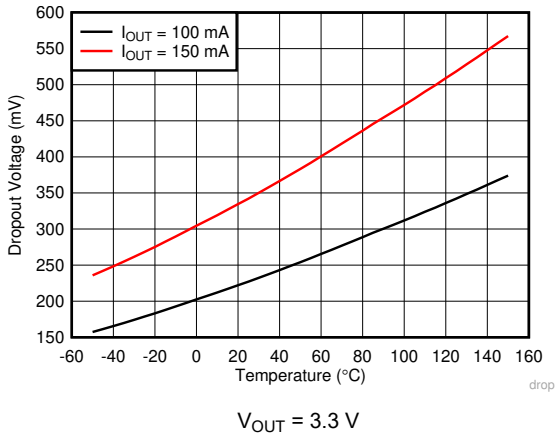


**Figure 6-5. Dropout Voltage vs Output Current**

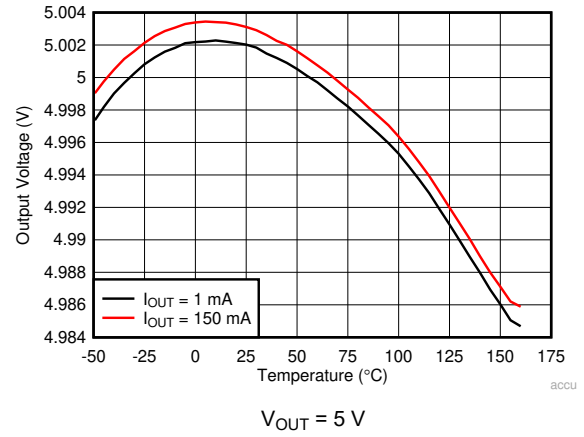


**Figure 6-6. Dropout Voltage vs Ambient Temperature**

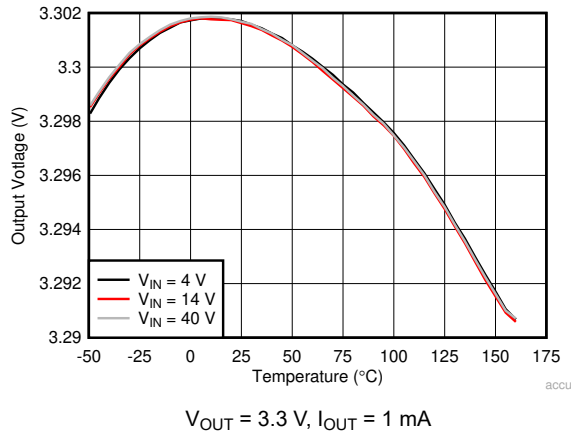




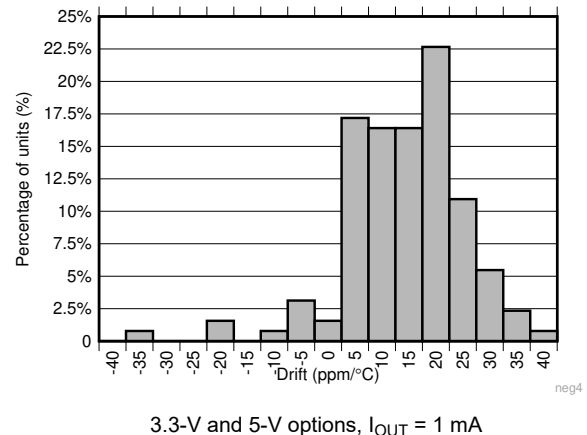
**Figure 6-7. Dropout Voltage vs Ambient Temperature**



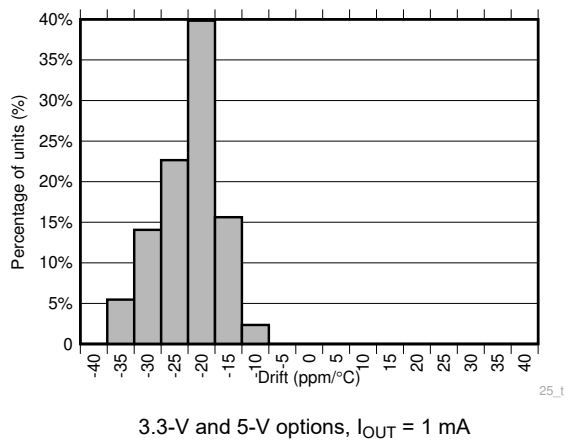
**Figure 6-8. Output Voltage vs Ambient Temperature**



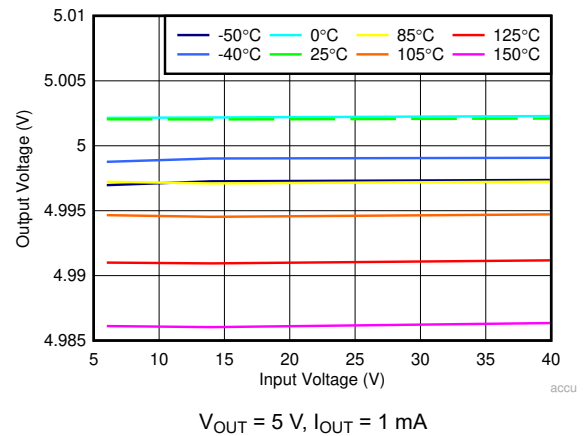
**Figure 6-9. Output Voltage vs Ambient Temperature**



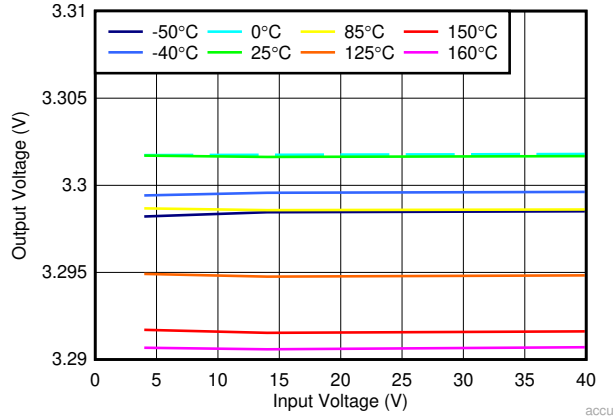
**Figure 6-10. Temperature Drift Histogram (-40°C to +25°C)**



**Figure 6-11. Temperature Drift Histogram (25°C to 150°C)**

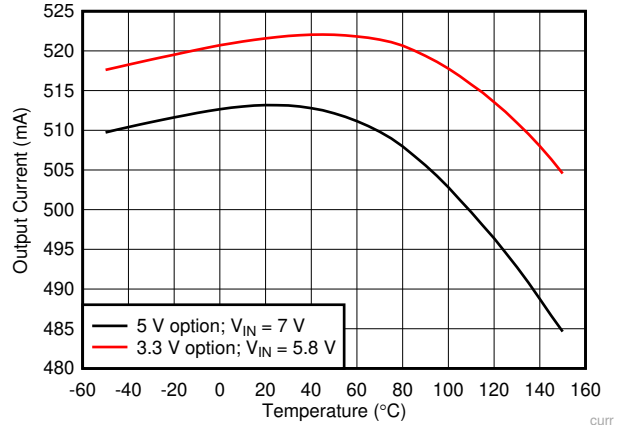


**Figure 6-12. Output Voltage vs Input Voltage**



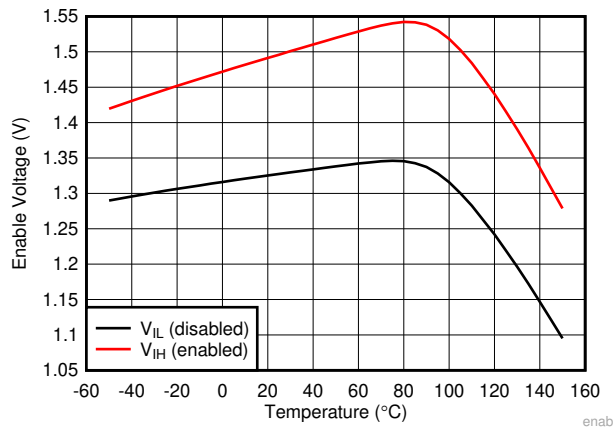
$V_{OUT} = 3.3\text{ V}, I_{OUT} = 1\text{ mA}$

**Figure 6-13. Output Voltage vs Input Voltage**

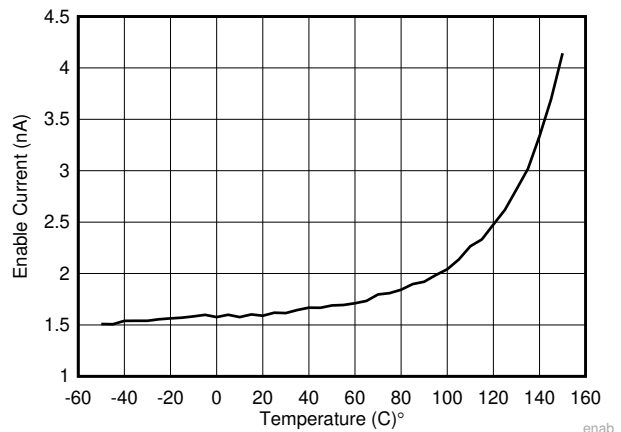


$V_{OUT}$  is shorted to  $90\% \times V_{OUT(NOM)}$

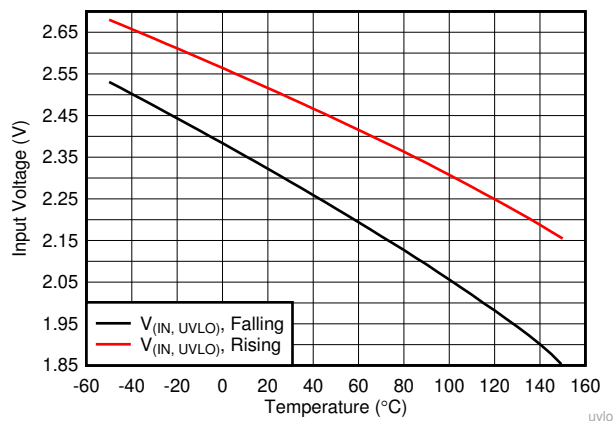
**Figure 6-14. Output Current Limit vs Ambient Temperature**



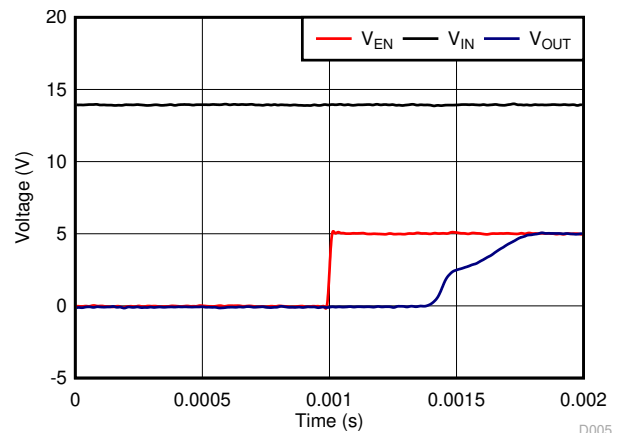
**Figure 6-15. Enable Voltage vs Ambient Temperature**



**Figure 6-16. Enable Current vs Ambient Temperature**

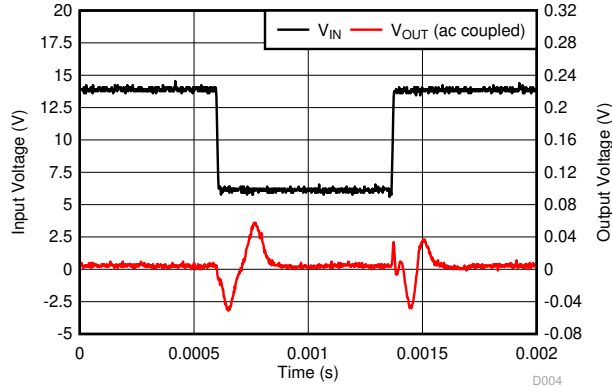


**Figure 6-17. UVLO vs Ambient Temperature**



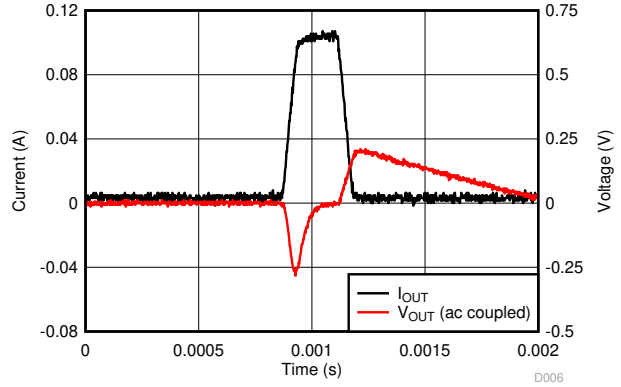
$V_{OUT} = 5\text{ V}, C_{IN} = 1\ \mu\text{F}, C_{OUT} = 1\ \mu\text{F}$

**Figure 6-18. Startup With Enable**



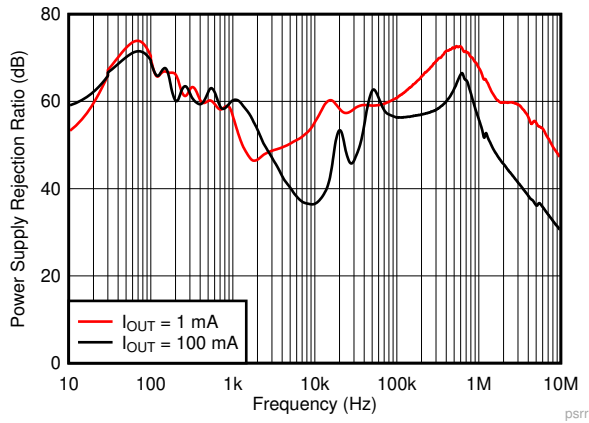
$V_{OUT} = 3.3\text{ V}$ ,  $C_{IN} = 0\ \mu\text{F}$ ,  $C_{OUT} = 1\ \mu\text{F}$ ,  $I_{OUT} = 100\text{ mA}$ , Slew rate =  $1\text{ V}/\mu\text{s}$

Figure 6-19. Line Transient



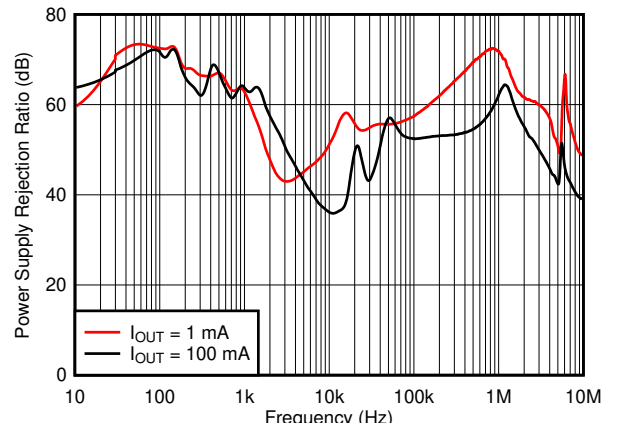
$V_{OUT} = 5\text{ V}$ ,  $C_{IN} = 1\ \mu\text{F}$ ,  $C_{OUT} = 1\ \mu\text{F}$ ,  $I_{OUT} = 1\text{ mA} \rightarrow 100\text{ mA}$  →  $1\text{ mA}$ , Slew rate =  $1\text{ mA}/\mu\text{s}$

Figure 6-20. Load Transient



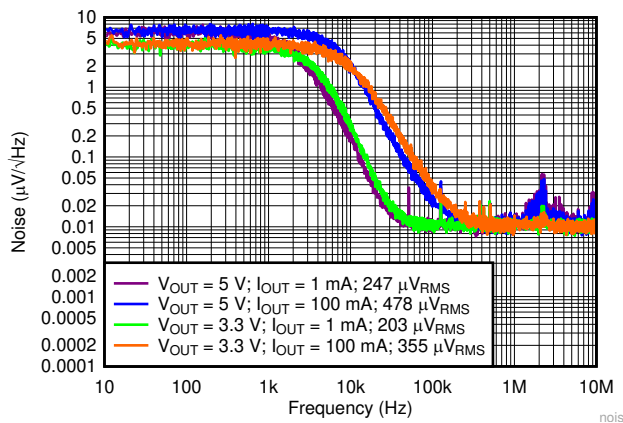
$V_{OUT} = 5\text{ V}$ ,  $C_{IN} = 0\ \mu\text{F}$ ,  $C_{OUT} = 10\ \mu\text{F}$

Figure 6-21. PSRR vs Frequency



$V_{OUT} = 3.3\text{ V}$ ,  $C_{IN} = 0\ \mu\text{F}$ ,  $C_{OUT} = 10\ \mu\text{F}$

Figure 6-22. PSRR vs Frequency



$C_{IN} = 0.1\ \mu\text{F}$ ,  $C_{OUT} = 10\ \mu\text{F}$

Figure 6-23. Noise vs Frequency

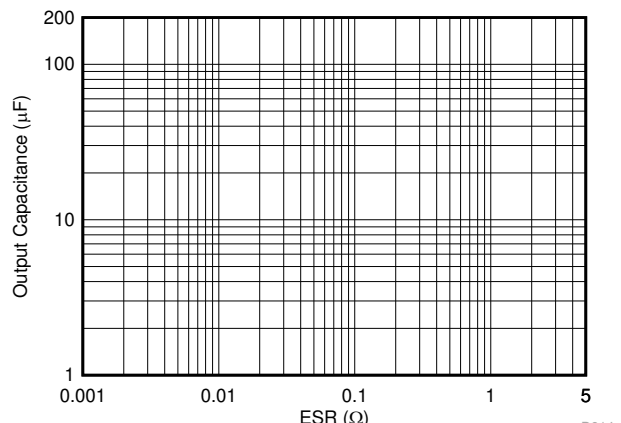


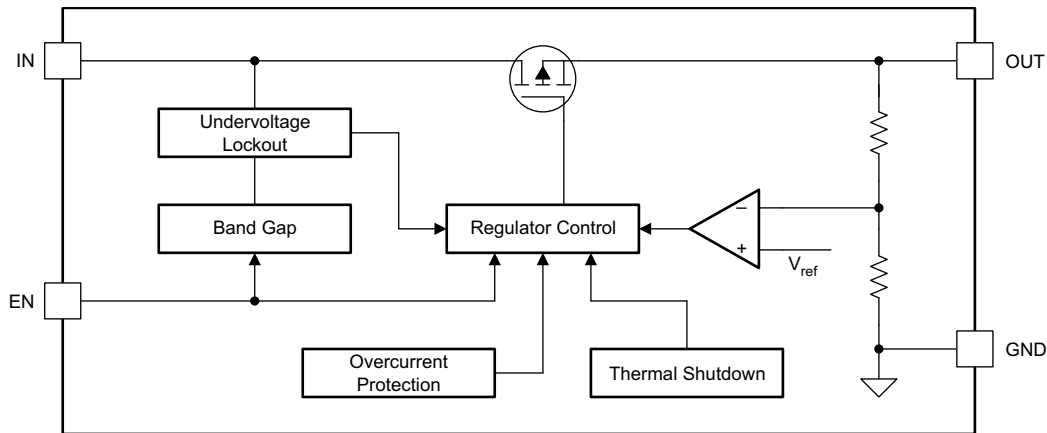
Figure 6-24. Output Capacitance vs ESR Stability

## 7 Detailed Description

### 7.1 Overview

The TPS7B81-Q1 is a 40-V, 150-mA, low-dropout (LDO) linear regulator with ultralow quiescent current. This voltage regulator consumes only 3  $\mu\text{A}$  of quiescent current at light load, and is quite suitable for the automotive always-on application.

### 7.2 Functional Block Diagram



### 7.3 Feature Description

#### 7.3.1 Device Enable (EN)

The EN pin is a high-voltage-tolerant pin. A high input activates the device and turns the regulation on. Connect this pin to an external microcontroller or a digital circuit to enable and disable the device, or connect to the IN pin for self-bias applications.

#### 7.3.2 Undervoltage Shutdown

This device has an integrated undervoltage lockout (UVLO) circuit to shut down the output if the input voltage ( $V_{\text{IN}}$ ) falls below an internal UVLO threshold ( $V_{\text{UVLO}}$ ). This feature ensures that the regulator does not latch into an unknown state during low-input-voltage conditions. If the input voltage has a negative transient that drops below the UVLO threshold and recovers, the regulator shuts down and powers up with a normal power-up sequence when the input voltage is above the required level.

#### 7.3.3 Current Limit

This device features current-limit protection to keep the device in a safe operating area when an overload or output short-to-ground condition occurs. This feature protects the device from excessive power dissipation. For example, during a short-circuit condition on the output, the fault protection limits the current through the pass element to  $I_{\text{LIM}}$  to protect the device from excessive power dissipation.

#### 7.3.4 Thermal Shutdown

This device incorporates a thermal shutdown (TSD) circuit as protection from overheating. For continuous normal operation, the junction temperature must not exceed the TSD trip point. If the junction temperature exceeds the TSD trip point, the output turns off. When the junction temperature falls below the TSD trip point minus the thermal shutdown hysteresis, the output turns on again.

## 7.4 Device Functional Modes

### 7.4.1 Operation With $V_{IN}$ Lower Than 3 V

The device normally operates with input voltages above 3 V. The device can also operate at lower input voltages; the maximum UVLO voltage is 2.7 V. The device does not operate at input voltages below the actual UVLO voltage.

### 7.4.2 Operation With $V_{IN}$ Larger Than 3 V

When  $V_{IN}$  is greater than 3 V, if  $V_{IN}$  is also higher than the output set value plus the device dropout voltage,  $V_{OUT}$  is equal to the set value. Otherwise,  $V_{OUT}$  is equal to  $V_{IN}$  minus the dropout voltage.

**Table 7-1. Device Functional Mode Comparison**

OPERATING MODE	PARAMETER			
Normal mode	$V_{IN} > V_{OUT(nom)} + V_{(Dropout)}$ and $V_{IN} \geq 3\text{ V}$	$V_{EN} > V_{IH}$	$I_{OUT} < I_{CL}$	$T_J < 160^\circ\text{C}$
Dropout mode	$3\text{ V} \leq V_{IN} < V_{OUT(nom)} + V_{(Dropout)}$	$V_{EN} > V_{IH}$	$I_{OUT} < I_{CL}$	$T_J < 160^\circ\text{C}$
Disabled mode (any true condition disables the device)	$V_{IN} < V_{(IN, UVLO)}$	$V_{EN} < V_{IL}$	—	$T_J > 160^\circ\text{C}$

## 8 Application and Implementation

### Note

Information in the following applications sections is not part of the TI component specification, and TI does not warrant its accuracy or completeness. TI's customers are responsible for determining suitability of components for their purposes. Customers should validate and test their design implementation to confirm system functionality.

### 8.1 Application Information

The TPS7B81-Q1 is a 150-mA, 40-V, low-dropout (LDO) linear regulator with ultralow quiescent current. The PSpice transient model is available for download on the product folder and can be used to evaluate the basic function of the device.

#### 8.1.1 Power Dissipation

Circuit reliability demands that proper consideration is given to device power dissipation, location of the circuit on the printed circuit board (PCB), and correct sizing of the thermal plane. The PCB area around the regulator must be as free as possible of other heat-generating devices that cause added thermal stresses.

As a first-order approximation, power dissipation in the regulator depends on the input-to-output voltage difference and load conditions.  $P_D$  can be approximated using [Equation 1](#):

$$P_D = (V_{IN} - V_{OUT}) \times I_{OUT} \quad (1)$$

An important note is that power dissipation can be minimized, and thus greater efficiency achieved, by proper selection of the system voltage rails. Proper selection allows the minimum input-to-output voltage differential to be obtained. The low dropout of the device allows for maximum efficiency across a wide range of output voltages.

The main heat conduction path for the device is through the thermal pad on the package. As such, the thermal pad must be soldered to a copper pad area under the device. This pad area contains an array of plated vias that conduct heat to any inner plane areas or to a bottom-side copper plane.

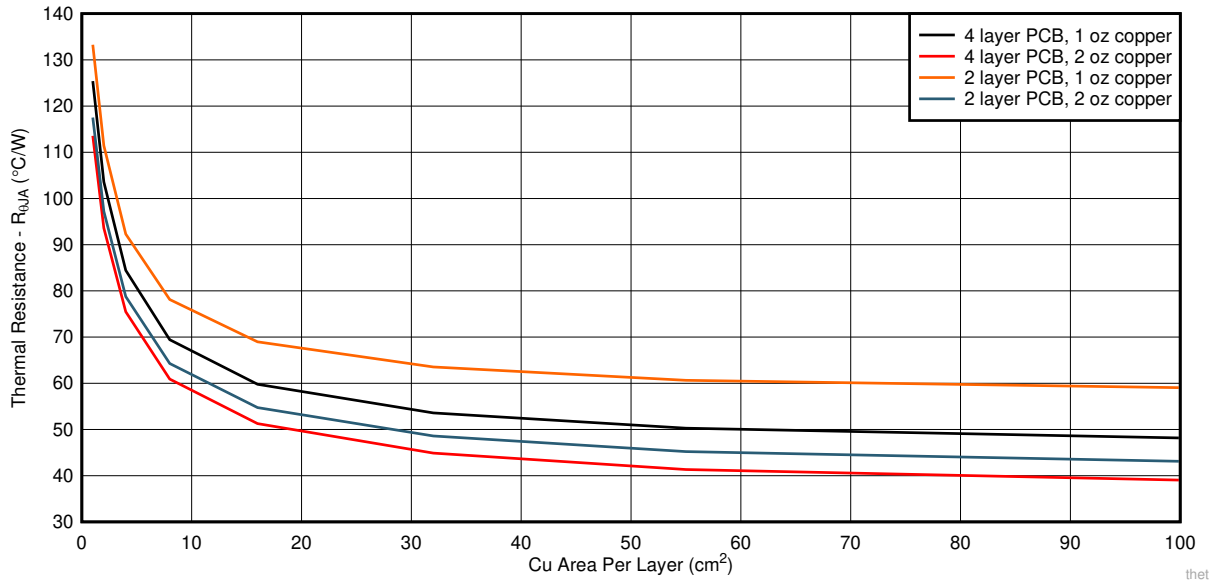
The maximum power dissipation determines the maximum allowable junction temperature ( $T_J$ ) for the device. Power dissipation and junction temperature are most often related by the junction-to-ambient thermal resistance ( $R_{\theta JA}$ ) of the combined PCB, device package, and the temperature of the ambient air ( $T_A$ ), according to [Equation 1](#). The equation is rearranged for output current in [Equation 1](#).

$$T_J = T_A + R_{\theta JA} \times P_D \quad (2)$$

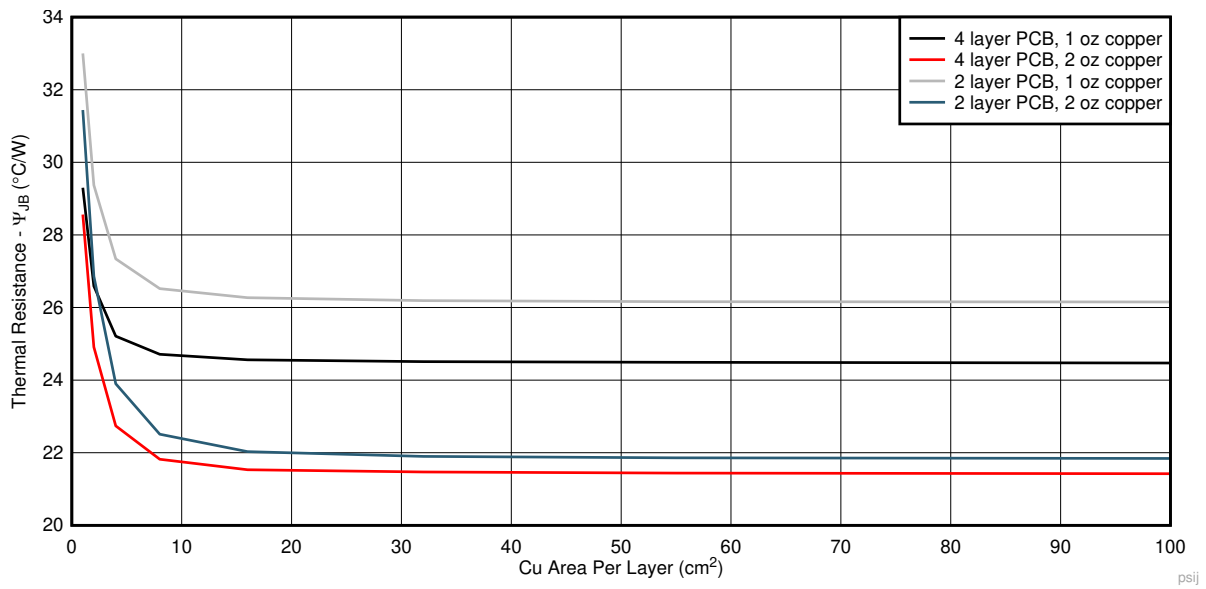
$$I_{OUT} = (T_J - T_A) / [R_{\theta JA} \times (V_{IN} - V_{OUT})] \quad (3)$$

Unfortunately, this thermal resistance ( $R_{\theta JA}$ ) is highly dependent on the heat-spreading capability built into the particular PCB design, and therefore varies according to the total copper area, copper weight, and location of the planes. The  $R_{\theta JA}$  recorded in the v table is determined by the JEDEC standard, PCB, and copper-spreading area, and is only used as a relative measure of package thermal performance. Note that for a well-designed thermal layout,  $R_{\theta JA}$  is actually the sum of the package junction-to-case (bottom) thermal resistance ( $R_{\theta JCbot}$ ) plus the thermal resistance contribution by the PCB copper.

[Figure 8-1](#) through [Figure 8-6](#) show the functions of  $R_{\theta JA}$  and  $\psi_{JB}$  vs. copper area and thickness. These plots are generated with a 101.6 mm x 101.6 mm x 1.6mm PCB of two and four layers. For the four layer board, inner planes use 1 oz copper thickness. Outer layers are simulated with both 1 oz and 2 oz copper thickness. A 2 x 1 array of thermal vias of 300  $\mu$ m drill diameter and 25  $\mu$ m Cu plating is located beneath the thermal pad of the device. The thermal vias connect the top layer, the bottom layer and, in the case of the 4-layer board, the first inner GND plane. Each of the layers has a copper plane of equal area.



**Figure 8-1.  $R_{\theta JA}$  versus Cu Area for the WSON (DRV) Package**



**Figure 8-2.  $\psi_{JB}$  versus Cu Area for the WSON (DRV) Package**

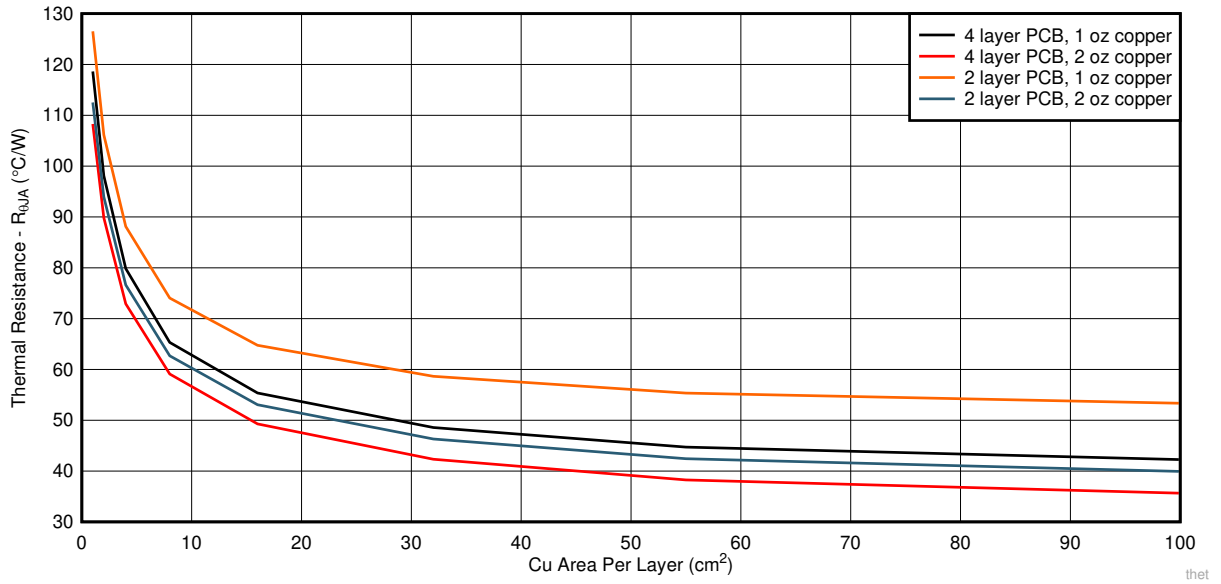


Figure 8-3.  $R_{\theta JA}$  versus Cu Area for the HVSSOP (DGN) Package

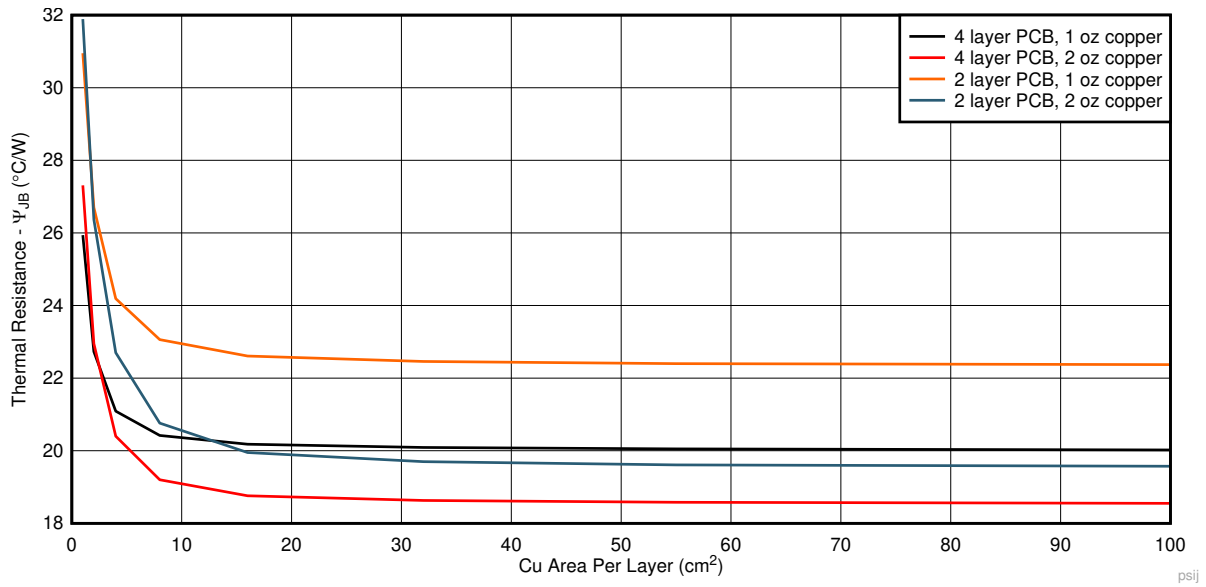
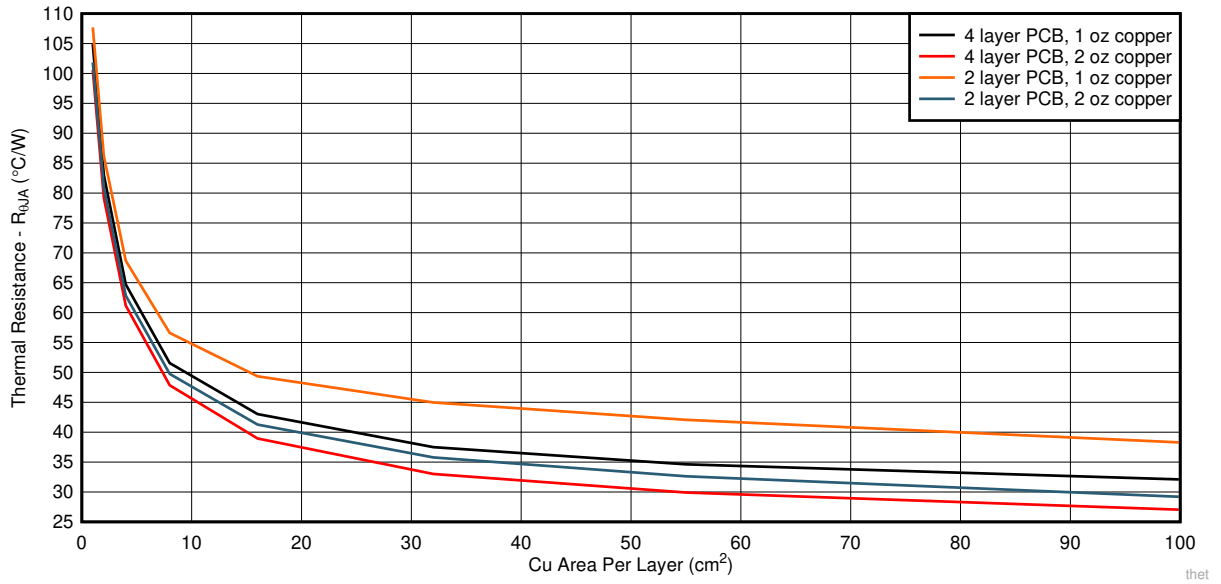
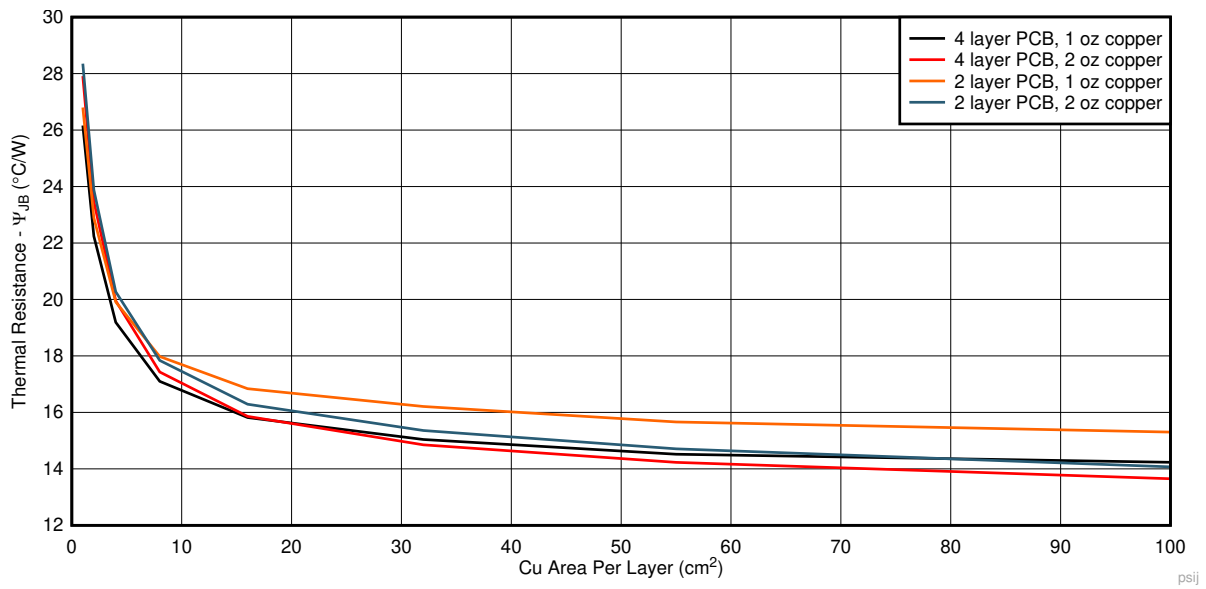


Figure 8-4.  $\psi_{JB}$  versus Cu Area for the HVSSOP (DGN) Package





**Figure 8-5.  $R_{\theta JA}$  versus Cu Area for the TO-252 (KVU) Package**



**Figure 8-6.  $\psi_{JB}$  versus Cu Area for the TO-252 (KVU) Package**

### 8.1.1.1 Estimating Junction Temperature

The JEDEC standard now recommends the use of psi ( $\Psi$ ) thermal metrics to estimate the junction temperatures of the LDO when in-circuit on a typical PCB board application. These metrics are not strictly speaking thermal resistances, but rather offer practical and relative means of estimating junction temperatures. These psi metrics are determined to be significantly independent of the copper-spreading area. The key thermal metrics ( $\Psi_{JT}$  and  $\Psi_{JB}$ ) are given in the [Section 6.4](#) table and are used in accordance with [Equation 1](#).

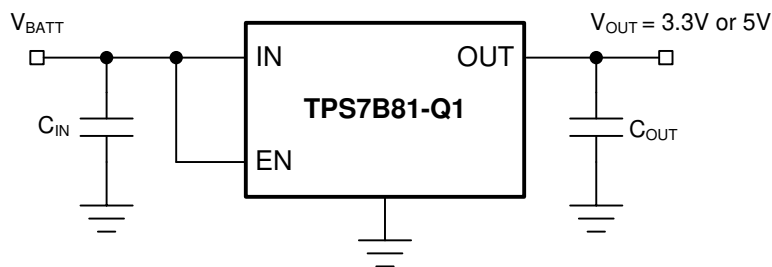
$$\begin{aligned} \Psi_{JT}: T_J &= T_T + \Psi_{JT} \times P_D \\ \Psi_{JB}: T_J &= T_B + \Psi_{JB} \times P_D \end{aligned} \tag{4}$$

where:

- $P_D$  is the power dissipated as explained in [Equation 1](#)
- $T_T$  is the temperature at the center-top of the device package, and
- $T_B$  is the PCB surface temperature measured 1 mm from the device package and centered on the package edge

## 8.2 Typical Application

[Figure 8-7](#) shows a typical application circuit for the TPS7B81-Q1. Different external component values can be used, depending on the end application. An application may require a larger output capacitor during fast load steps to prevent a large drop on the output voltage. TI recommends using a low-equivalent series resistance (ESR) ceramic capacitor with an X5R- or X7R-type dielectric.



**Figure 8-7. TPS7B81-Q1 Typical Application Schematic**

### 8.2.1 Design Requirements

Use the parameters listed in [Table 8-1](#) for this design example.

**Table 8-1. Design Requirements Parameters**

PARAMETER	VALUE
Input voltage range	3 V to 40 V
Output voltage	5 V or 3.3 V
Output current	150 mA maximum

### 8.2.2 Detailed Design Procedure

To begin the design process, determine the following:

- Input voltage range
- Output voltage
- Output current

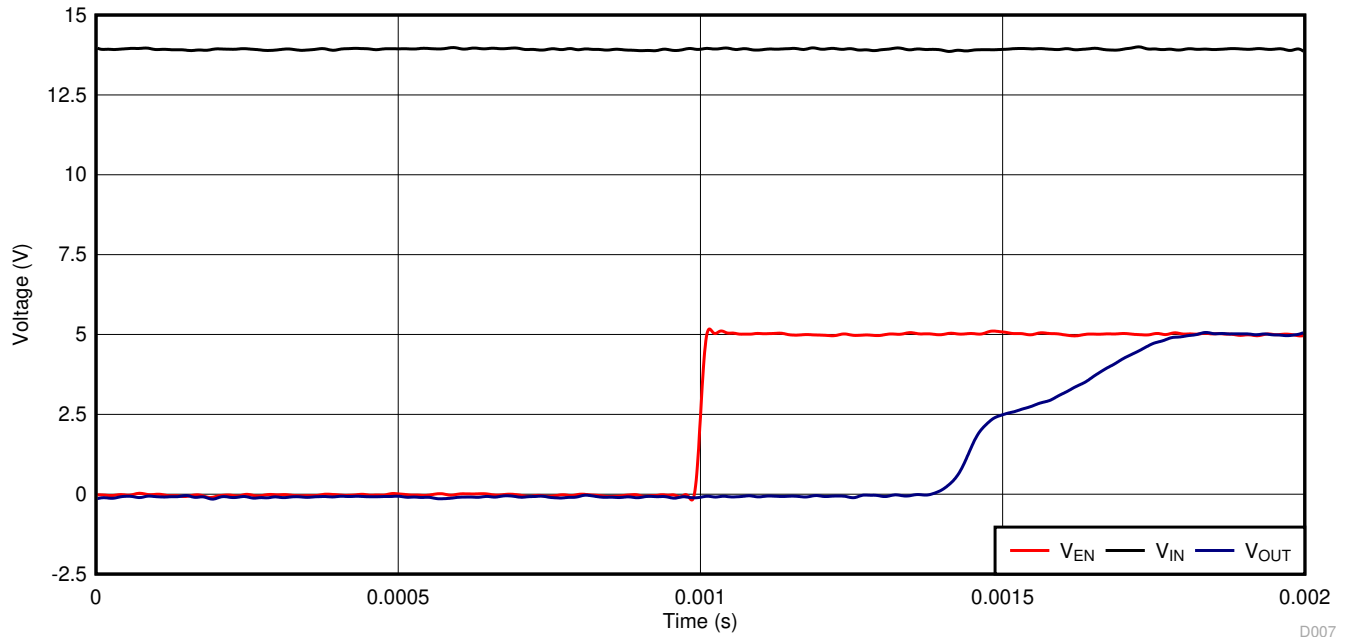
#### 8.2.2.1 Input Capacitor

Although an input capacitor is not required for stability, good analog design practice is to connect a 10- $\mu$ F to 22- $\mu$ F capacitor from IN to GND. This capacitor counteracts reactive input sources and improves transient response, input ripple rejection, and PSRR. The voltage rating must be greater than the maximum input voltage.

### 8.2.2.2 Output Capacitor

To ensure the stability of the TPS7B81-Q1, the device requires an output capacitor with a value in the range from 1  $\mu\text{F}$  to 200  $\mu\text{F}$  and with an ESR range between 0.001  $\Omega$  and 5  $\Omega$ . TI recommends selecting a ceramic capacitor with low ESR to improve the load transient response.

### 8.2.3 Application Curve



**Figure 8-8. TPS7B81-Q1 Power-Up Waveform (5 V)**

## 9 Power Supply Recommendations

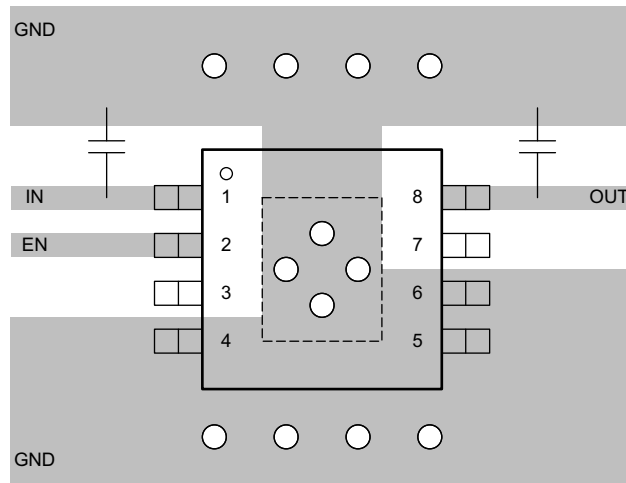
The device is designed to operate from an input-voltage supply range from 3 V to 40 V. The input supply must be well regulated. If the input supply is located more than a few inches from the TPS7B81-Q1, TI recommends adding a capacitor with a value greater than or equal to 10  $\mu\text{F}$  with a 0.1- $\mu\text{F}$  bypass capacitor in parallel at the input.

## 10 Layout

### 10.1 Layout Guidelines

Layout is an important step for LDO power supplies, especially for high-voltage and large-output-current supplies. If the layout is not carefully designed, the regulator can fail to deliver enough output current because of thermal limitations. To improve the thermal performance of the device, and to maximize the current output at high ambient temperature, spread the copper under the thermal pad as far as possible and put enough thermal vias on the copper under the thermal pad. [Figure 10-1](#) shows an example layout.

### 10.2 Layout Example



**Figure 10-1. TPSB81-Q1 Example Layout Diagram**

## 11 Device and Documentation Support

### 11.1 Receiving Notification of Documentation Updates

To receive notification of documentation updates, navigate to the device product folder on [ti.com](http://ti.com). Click on *Subscribe to updates* to register and receive a weekly digest of any product information that has changed. For change details, review the revision history included in any revised document.

### 11.2 Support Resources

[TI E2E™ support forums](#) are an engineer's go-to source for fast, verified answers and design help — straight from the experts. Search existing answers or ask your own question to get the quick design help you need.

Linked content is provided "AS IS" by the respective contributors. They do not constitute TI specifications and do not necessarily reflect TI's views; see TI's [Terms of Use](#).

### 11.3 Trademarks

PowerPAD™ and TI E2E™ are trademarks of Texas Instruments Incorporated. All other trademarks are the property of their respective owners.

### 11.4 Electrostatic Discharge Caution



This integrated circuit can be damaged by ESD. Texas Instruments recommends that all integrated circuits be handled with appropriate precautions. Failure to observe proper handling and installation procedures can cause damage.

ESD damage can range from subtle performance degradation to complete device failure. Precision integrated circuits may be more susceptible to damage because very small parametric changes could cause the device not to meet its published specifications.

### 11.5 Glossary

[TI Glossary](#) This glossary lists and explains terms, acronyms, and definitions.

## 12 Mechanical, Packaging, and Orderable Information

The following pages include mechanical, packaging, and orderable information. This information is the most current data available for the designated devices. This data is subject to change without notice and revision of this document. For browser-based versions of this data sheet, refer to the left-hand navigation.

## PACKAGING INFORMATION

Orderable Device	Status (1)	Package Type	Package Drawing	Pins	Package Qty	Eco Plan (2)	Lead finish/ Ball material (6)	MSL Peak Temp (3)	Op Temp (°C)	Device Marking (4/5)	Samples
TPS7B8125QDGNRQ1	ACTIVE	HVSSOP	DGN	8	2500	RoHS & Green	NIPDAUAG	Level-2-260C-1 YEAR	-40 to 150	26GX	<a href="#">Samples</a>
TPS7B8133QDGNRQ1	ACTIVE	HVSSOP	DGN	8	2500	RoHS & Green	NIPDAUAG	Level-2-260C-1 YEAR	-40 to 150	1VTX	<a href="#">Samples</a>
TPS7B8133QDRVRQ1	ACTIVE	WSO	DRV	6	3000	RoHS & Green	NIPDAU	Level-2-260C-1 YEAR	-40 to 150	1X2H	<a href="#">Samples</a>
TPS7B8133QKVURQ1	ACTIVE	TO-252	KVU	5	2500	RoHS & Green	SN	Level-3-260C-168 HR	-40 to 150	7B8133Q1	<a href="#">Samples</a>
TPS7B8150QDGNRQ1	ACTIVE	HVSSOP	DGN	8	2500	RoHS & Green	NIPDAUAG	Level-2-260C-1 YEAR	-40 to 150	1VUX	<a href="#">Samples</a>
TPS7B8150QDRVRQ1	ACTIVE	WSO	DRV	6	3000	RoHS & Green	NIPDAU	Level-2-260C-1 YEAR	-40 to 150	1WNH	<a href="#">Samples</a>
TPS7B8150QKVURQ1	ACTIVE	TO-252	KVU	5	2500	RoHS & Green	SN	Level-3-260C-168 HR	-40 to 150	7B8150Q1	<a href="#">Samples</a>

(1) The marketing status values are defined as follows:

**ACTIVE:** Product device recommended for new designs.

**LIFEBUY:** TI has announced that the device will be discontinued, and a lifetime-buy period is in effect.

**NRND:** Not recommended for new designs. Device is in production to support existing customers, but TI does not recommend using this part in a new design.

**PREVIEW:** Device has been announced but is not in production. Samples may or may not be available.

**OBSOLETE:** TI has discontinued the production of the device.

(2) **RoHS:** TI defines "RoHS" to mean semiconductor products that are compliant with the current EU RoHS requirements for all 10 RoHS substances, including the requirement that RoHS substance do not exceed 0.1% by weight in homogeneous materials. Where designed to be soldered at high temperatures, "RoHS" products are suitable for use in specified lead-free processes. TI may reference these types of products as "Pb-Free".

**RoHS Exempt:** TI defines "RoHS Exempt" to mean products that contain lead but are compliant with EU RoHS pursuant to a specific EU RoHS exemption.

**Green:** TI defines "Green" to mean the content of Chlorine (Cl) and Bromine (Br) based flame retardants meet JS709B low halogen requirements of <=1000ppm threshold. Antimony trioxide based flame retardants must also meet the <=1000ppm threshold requirement.

(3) MSL, Peak Temp. - The Moisture Sensitivity Level rating according to the JEDEC industry standard classifications, and peak solder temperature.

(4) There may be additional marking, which relates to the logo, the lot trace code information, or the environmental category on the device.

(5) Multiple Device Markings will be inside parentheses. Only one Device Marking contained in parentheses and separated by a "-" will appear on a device. If a line is indented then it is a continuation of the previous line and the two combined represent the entire Device Marking for that device.

<sup>(6)</sup> Lead finish/Ball material - Orderable Devices may have multiple material finish options. Finish options are separated by a vertical ruled line. Lead finish/Ball material values may wrap to two lines if the finish value exceeds the maximum column width.

**Important Information and Disclaimer:**The information provided on this page represents TI's knowledge and belief as of the date that it is provided. TI bases its knowledge and belief on information provided by third parties, and makes no representation or warranty as to the accuracy of such information. Efforts are underway to better integrate information from third parties. TI has taken and continues to take reasonable steps to provide representative and accurate information but may not have conducted destructive testing or chemical analysis on incoming materials and chemicals. TI and TI suppliers consider certain information to be proprietary, and thus CAS numbers and other limited information may not be available for release.

In no event shall TI's liability arising out of such information exceed the total purchase price of the TI part(s) at issue in this document sold by TI to Customer on an annual basis.

**OTHER QUALIFIED VERSIONS OF TPS7B81-Q1 :**

- Catalog : [TPS7B81](#)

NOTE: Qualified Version Definitions:

- Catalog - TI's standard catalog product

**TAPE AND REEL INFORMATION**

**QUADRANT ASSIGNMENTS FOR PIN 1 ORIENTATION IN TAPE**


\*All dimensions are nominal

Device	Package Type	Package Drawing	Pins	SPQ	Reel Diameter (mm)	Reel Width W1 (mm)	A0 (mm)	B0 (mm)	K0 (mm)	P1 (mm)	W (mm)	Pin1 Quadrant
TPS7B8125QDGNRQ1	HVSSOP	DGN	8	2500	330.0	12.4	5.3	3.4	1.4	8.0	12.0	Q1
TPS7B8133QDGNRQ1	HVSSOP	DGN	8	2500	330.0	12.4	5.3	3.4	1.4	8.0	12.0	Q1
TPS7B8133QDRVRQ1	WSOP	DRV	6	3000	180.0	8.4	2.3	2.3	1.15	4.0	8.0	Q2
TPS7B8133QKVURQ1	TO-252	KVU	5	2500	330.0	16.4	6.9	10.5	2.7	8.0	16.0	Q2
TPS7B8150QDGNRQ1	HVSSOP	DGN	8	2500	330.0	12.4	5.3	3.4	1.4	8.0	12.0	Q1
TPS7B8150QDRVRQ1	WSOP	DRV	6	3000	180.0	8.4	2.3	2.3	1.15	4.0	8.0	Q2
TPS7B8150QKVURQ1	TO-252	KVU	5	2500	330.0	16.4	6.9	10.5	2.7	8.0	16.0	Q2



## TAPE AND REEL BOX DIMENSIONS

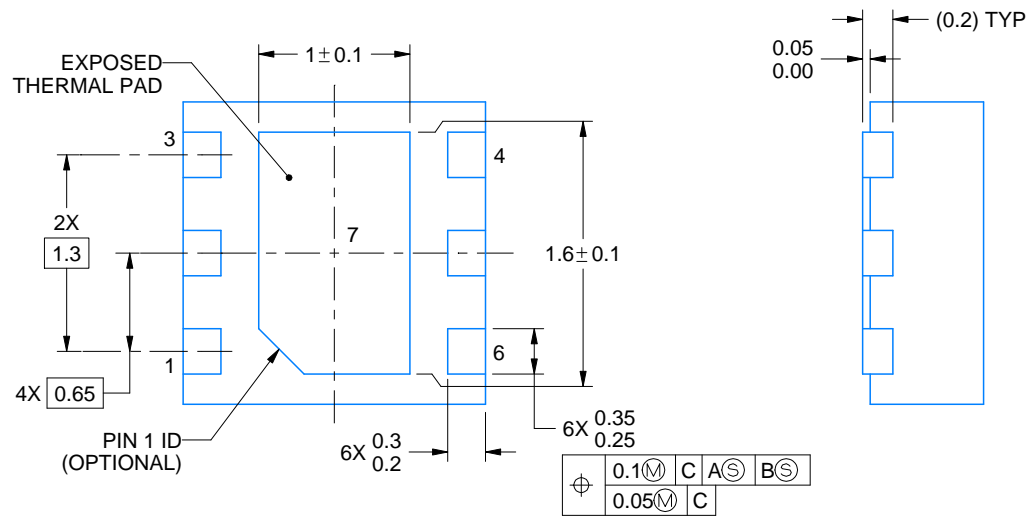
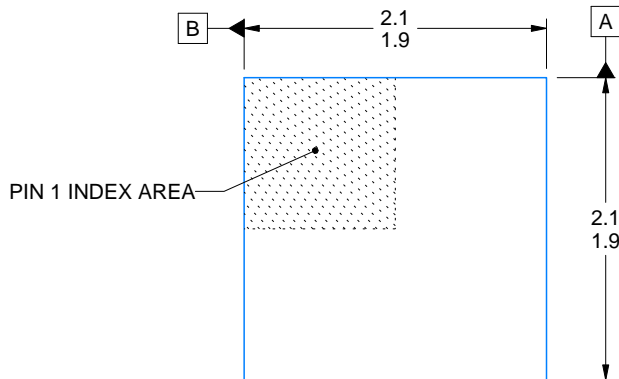
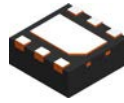


\*All dimensions are nominal

Device	Package Type	Package Drawing	Pins	SPQ	Length (mm)	Width (mm)	Height (mm)
TPS7B8125QDGNRQ1	HVSSOP	DGN	8	2500	366.0	364.0	50.0
TPS7B8133QDGNRQ1	HVSSOP	DGN	8	2500	366.0	364.0	50.0
TPS7B8133QDRVRQ1	WSON	DRV	6	3000	210.0	185.0	35.0
TPS7B8133QKVURQ1	TO-252	KVU	5	2500	340.0	340.0	38.0
TPS7B8150QDGNRQ1	HVSSOP	DGN	8	2500	366.0	364.0	50.0
TPS7B8150QDRVRQ1	WSON	DRV	6	3000	210.0	185.0	35.0
TPS7B8150QKVURQ1	TO-252	KVU	5	2500	340.0	340.0	38.0



Images above are just a representation of the package family, actual package may vary.  
Refer to the product data sheet for package details.



4222173/B 04/2018

NOTES:

1. All linear dimensions are in millimeters. Any dimensions in parenthesis are for reference only. Dimensioning and tolerancing per ASME Y14.5M.
2. This drawing is subject to change without notice.
3. The package thermal pad must be soldered to the printed circuit board for thermal and mechanical performance.

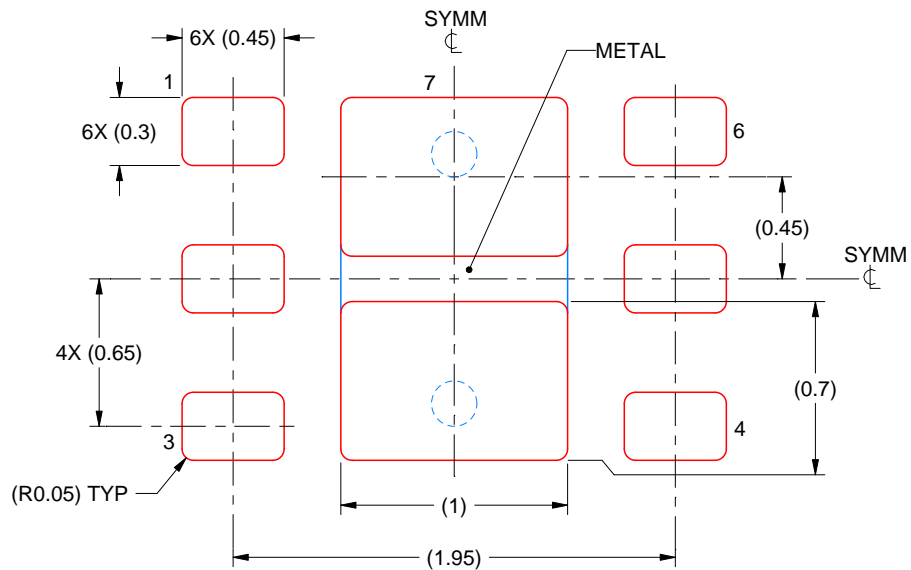


# EXAMPLE STENCIL DESIGN

DRV0006A

WSON - 0.8 mm max height

PLASTIC SMALL OUTLINE - NO LEAD



SOLDER PASTE EXAMPLE  
BASED ON 0.125 mm THICK STENCIL

EXPOSED PAD #7  
88% PRINTED SOLDER COVERAGE BY AREA UNDER PACKAGE  
SCALE:30X

4222173/B 04/2018

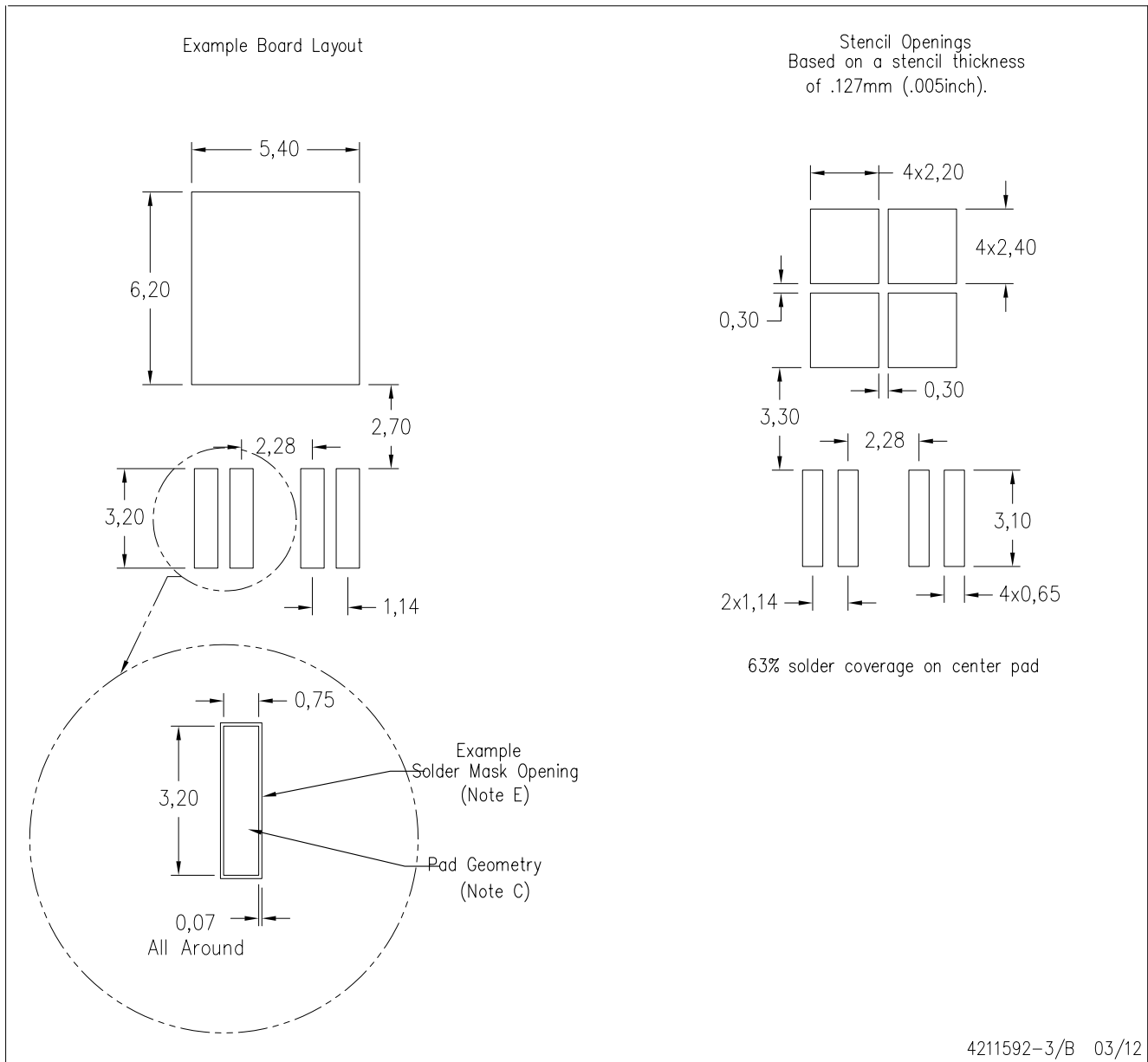
NOTES: (continued)

6. Laser cutting apertures with trapezoidal walls and rounded corners may offer better paste release. IPC-7525 may have alternate design recommendations.



KVU (R-PSFM-G5)

PLASTIC FLANGE MOUNT PACKAGE



- NOTES:
- A. All linear dimensions are in millimeters.
  - B. This drawing is subject to change without notice.
  - C. Publication IPC-SM-782 is an alternate information source for PCB land pattern designs.
  - D. Laser cutting apertures with trapezoidal walls and also rounding corners will offer better paste release. Customers should contact their board assembly site for stencil design recommendations. Refer to IPC-7525 for other stencil recommendations.
  - E. Customers should contact their board fabrication site for recommended solder mask tolerances and via tenting recommendations for vias placed in thermal pad.

## GENERIC PACKAGE VIEW

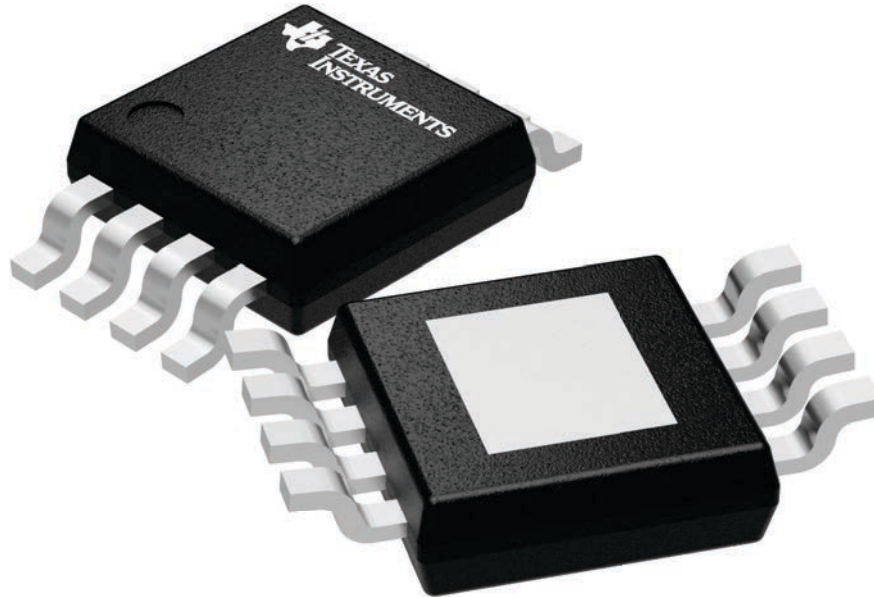
**DGN 8**

**PowerPAD VSSOP - 1.1 mm max height**

3 x 3, 0.65 mm pitch

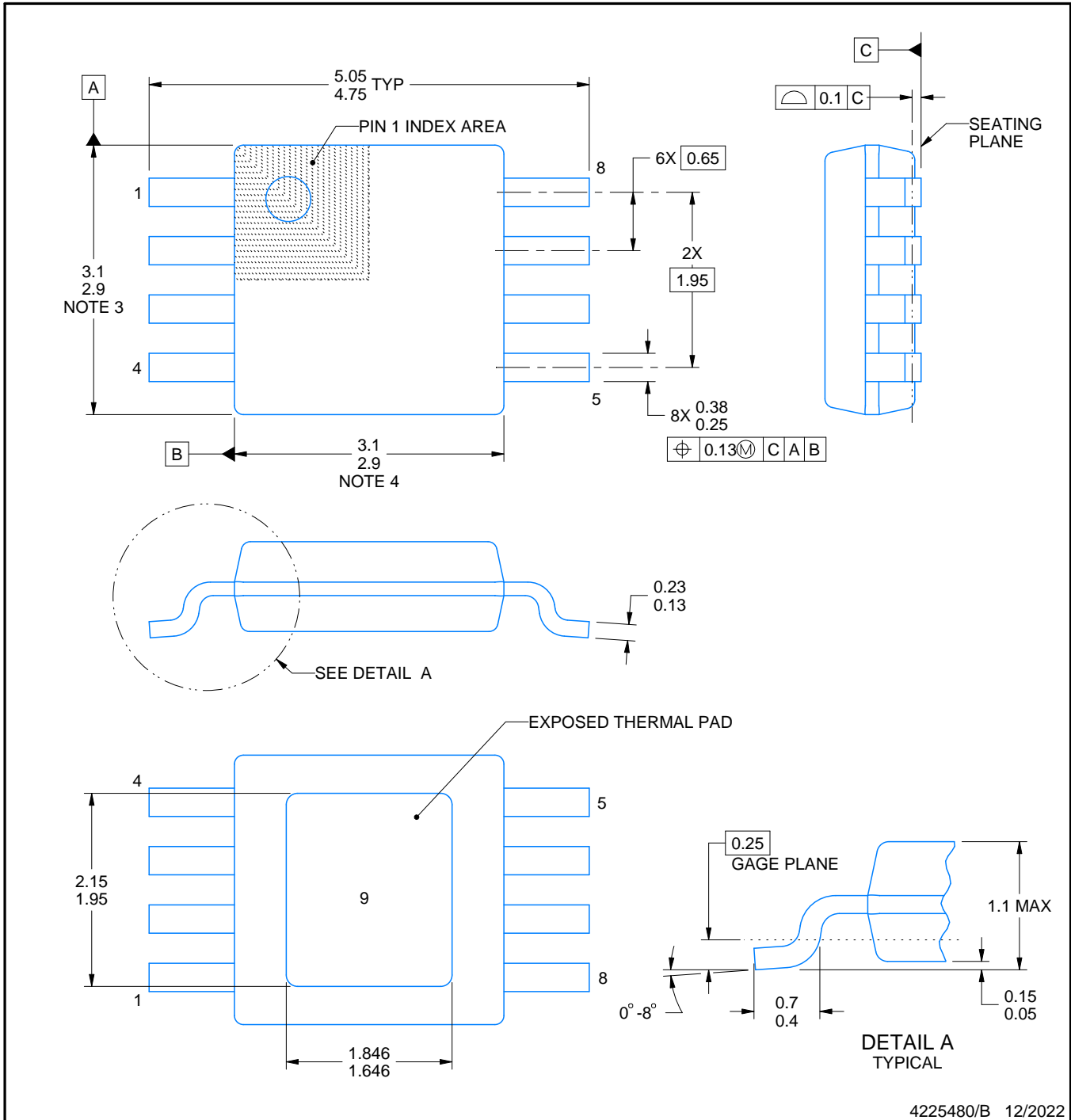
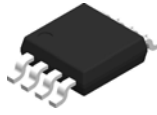
SMALL OUTLINE PACKAGE

This image is a representation of the package family, actual package may vary.  
Refer to the product data sheet for package details.



4225482/A





4225480/B 12/2022

PowerPAD is a trademark of Texas Instruments.

NOTES:

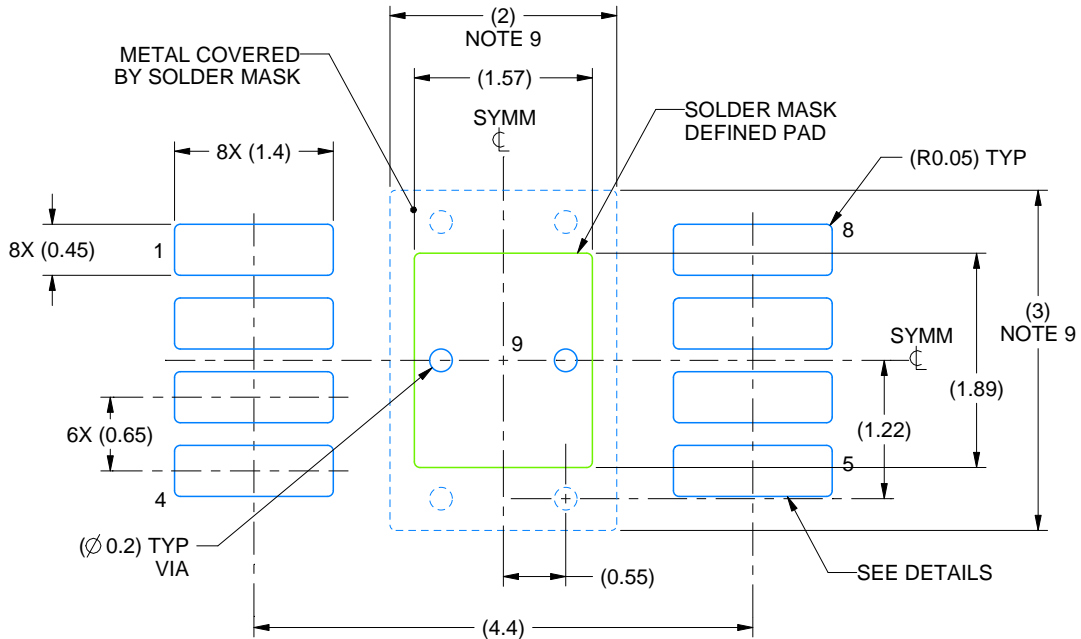
1. All linear dimensions are in millimeters. Any dimensions in parenthesis are for reference only. Dimensioning and tolerancing per ASME Y14.5M.
2. This drawing is subject to change without notice.
3. This dimension does not include mold flash, protrusions, or gate burrs. Mold flash, protrusions, or gate burrs shall not exceed 0.15 mm per side.
4. This dimension does not include interlead flash. Interlead flash shall not exceed 0.25 mm per side.
5. Reference JEDEC registration MO-187.

# EXAMPLE BOARD LAYOUT

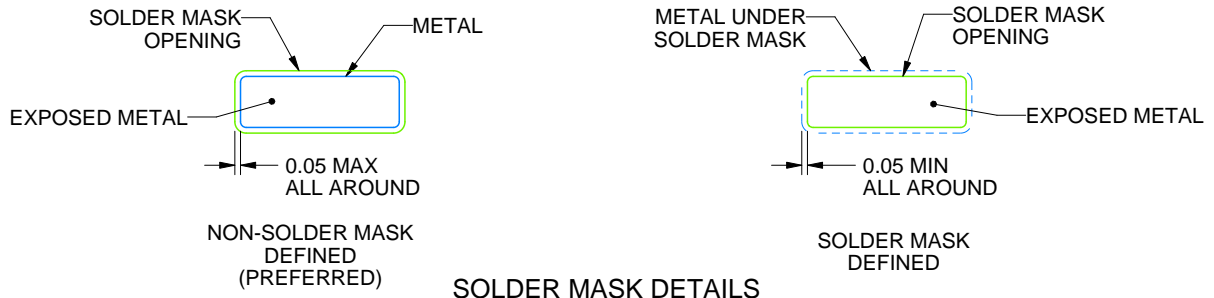
DGN0008G

PowerPAD™ VSSOP - 1.1 mm max height

SMALL OUTLINE PACKAGE



LAND PATTERN EXAMPLE  
EXPOSED METAL SHOWN  
SCALE: 15X



SOLDER MASK DETAILS

4225480/B 12/2022

NOTES: (continued)

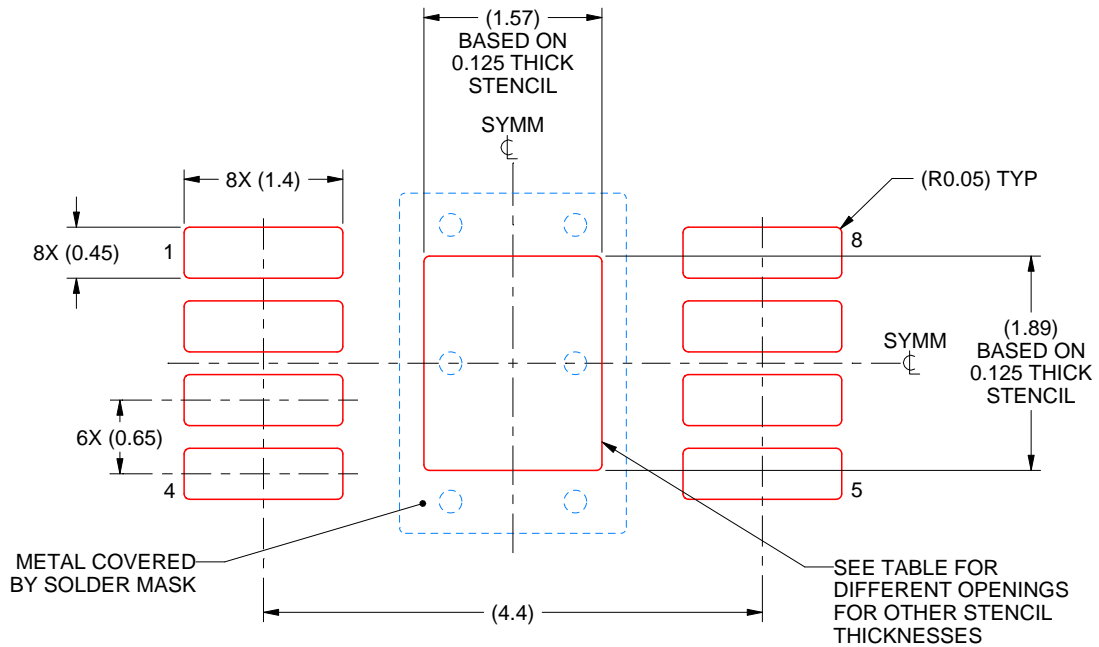
- 6. Publication IPC-7351 may have alternate designs.
- 7. Solder mask tolerances between and around signal pads can vary based on board fabrication site.
- 8. Vias are optional depending on application, refer to device data sheet. If any vias are implemented, refer to their locations shown on this view. It is recommended that vias under paste be filled, plugged or tented.
- 9. Size of metal pad may vary due to creepage requirement.

# EXAMPLE STENCIL DESIGN

DGN0008G

PowerPAD™ VSSOP - 1.1 mm max height

SMALL OUTLINE PACKAGE



**SOLDER PASTE EXAMPLE**  
EXPOSED PAD 9:  
100% PRINTED SOLDER COVERAGE BY AREA  
SCALE: 15X

STENCIL THICKNESS	SOLDER STENCIL OPENING
0.1	1.76 X 2.11
0.125	1.57 X 1.89 (SHOWN)
0.15	1.43 X 1.73
0.175	1.33 X 1.60

4225480/B 12/2022

NOTES: (continued)

10. Laser cutting apertures with trapezoidal walls and rounded corners may offer better paste release. IPC-7525 may have alternate design recommendations.
11. Board assembly site may have different recommendations for stencil design.

## IMPORTANT NOTICE AND DISCLAIMER

TI PROVIDES TECHNICAL AND RELIABILITY DATA (INCLUDING DATA SHEETS), DESIGN RESOURCES (INCLUDING REFERENCE DESIGNS), APPLICATION OR OTHER DESIGN ADVICE, WEB TOOLS, SAFETY INFORMATION, AND OTHER RESOURCES "AS IS" AND WITH ALL FAULTS, AND DISCLAIMS ALL WARRANTIES, EXPRESS AND IMPLIED, INCLUDING WITHOUT LIMITATION ANY IMPLIED WARRANTIES OF MERCHANTABILITY, FITNESS FOR A PARTICULAR PURPOSE OR NON-INFRINGEMENT OF THIRD PARTY INTELLECTUAL PROPERTY RIGHTS.

These resources are intended for skilled developers designing with TI products. You are solely responsible for (1) selecting the appropriate TI products for your application, (2) designing, validating and testing your application, and (3) ensuring your application meets applicable standards, and any other safety, security, regulatory or other requirements.

These resources are subject to change without notice. TI grants you permission to use these resources only for development of an application that uses the TI products described in the resource. Other reproduction and display of these resources is prohibited. No license is granted to any other TI intellectual property right or to any third party intellectual property right. TI disclaims responsibility for, and you will fully indemnify TI and its representatives against, any claims, damages, costs, losses, and liabilities arising out of your use of these resources.

TI's products are provided subject to [TI's Terms of Sale](#) or other applicable terms available either on [ti.com](https://www.ti.com) or provided in conjunction with such TI products. TI's provision of these resources does not expand or otherwise alter TI's applicable warranties or warranty disclaimers for TI products.

TI objects to and rejects any additional or different terms you may have proposed.

Mailing Address: Texas Instruments, Post Office Box 655303, Dallas, Texas 75265  
Copyright © 2023, Texas Instruments Incorporated

单击下面可查看定价，库存，交付和生命周期等信息

[>>TI\(德州仪器\)](#)