



Low-Power, Precision SINGLE-SUPPLY OPERATIONAL AMPLIFIERS

FEATURES

- **WIDE SUPPLY RANGE:**
Single Supply: $V_S = +2.7V$ to $+36V$
Dual Supply: $V_S = \pm 1.35V$ to $\pm 18V$
- **SPECIFIED PERFORMANCE:**
 $+2.7V$, $+5V$, and $\pm 15V$
- **LOW QUIESCENT CURRENT:** $250\mu A/amp$
- **LOW INPUT BIAS CURRENT:** $25nA$ max
- **LOW OFFSET VOLTAGE:** $100\mu V$ max
- **HIGH CMRR, PSRR, and A_{OL}**
- **SINGLE, DUAL, and QUAD VERSIONS**

DESCRIPTION

The OPA234 series low-cost op amps are ideal for single-supply, low-voltage, low-power applications. The series provides lower quiescent current than older "1013"-type products and comes in current industry-standard packages and pinouts. The combination of low offset voltage, high common-mode rejection, high power-supply rejection, and a wide supply range provides excellent accuracy and versatility. Single, dual, and quad versions have identical specifications for maximum design flexibility. These general-purpose op amps are ideal for portable and battery-powered applications.

The OPA234 series op amps operate from either single or dual supplies. In single-supply operation, the input common-mode range extends below ground and the output can swing to within 50mV of ground. Excellent phase margin makes the OPA234 series ideal for demanding applications, including high load capacitance. Dual and quad designs feature completely independent circuitry for lowest crosstalk and freedom from interaction.

Single version packages are in an SO-8 surface-mount and a space-saving MSOP-8 surface-mount. Dual packages are in an SO-8 surface-mount. Quad packages are in an SO-14 surface-mount. All are specified for $-40^\circ C$ to $+85^\circ C$ operation.

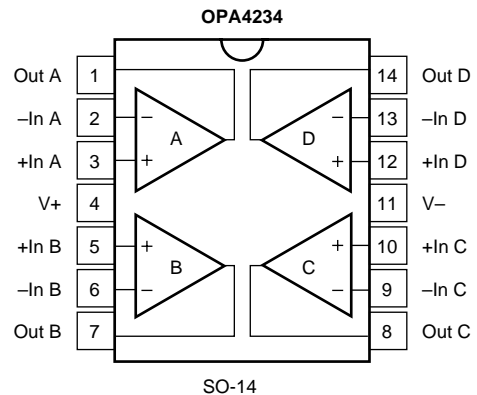
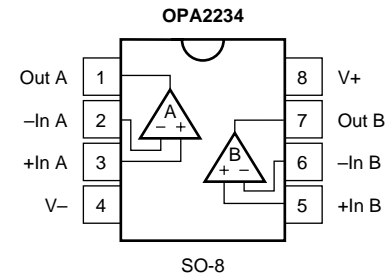
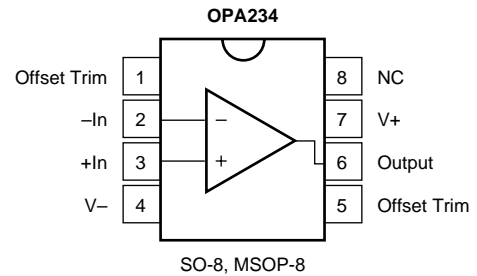

Please be aware that an important notice concerning availability, standard warranty, and use in critical applications of Texas Instruments semiconductor products and disclaimers thereto appears at the end of this data sheet.

All trademarks are the property of their respective owners.

ELECTRICAL CHARACTERISTICS: $V_S = +5V$

At $T_A = 25^\circ C$, $V_S = +5V$, $R_L = 10k\Omega$ connected to $V_S/2$, and $V_{OUT} = V_S/2$, unless otherwise noted.

| PARAMETER | CONDITION | OPA234U, E OPA2234U | | | OPA234UA, EA OPA2234UA OPA4234UA, U | | | UNITS |
|---|--------------------------------------|--|---|--|---|----------------------------|---------------------------------|--|
| | | MIN | TYP | MAX | MIN | TYP | MAX | |
| OFFSET VOLTAGE Input Offset Voltage OPA234E, EA vs Temperature ⁽¹⁾ vs Power Supply vs Time Channel Separation (Dual, Quad) | V_{OS} dV_{OS}/dT PSRR | $V_{CM} = 2.5V$ Operating Temperature Range $V_S = +2.7V$ to $+30V$, $V_{CM} = 1.7V$ | ± 40 ± 100 ± 0.5 3 0.2 0.3 | ± 100 ± 150 ± 3 10 | * | * | ± 250 ± 350 * | μV μV $\mu V/^\circ C$ $\mu V/V$ $\mu V/mo$ $\mu V/V$ |
| INPUT BIAS CURRENT Input Bias Current ⁽²⁾ Input Offset Current | I_B I_{OS} | $V_{CM} = 2.5V$ $V_{CM} = 2.5V$ | -15 ± 1 | -30 ± 5 | * | * | -50 * | nA nA |
| NOISE Input Voltage Noise Density Current Noise Density | v_n i_n | $f = 1kHz$ | 25 80 | | * | * | | nV/\sqrt{Hz} fA/\sqrt{Hz} |
| INPUT VOLTAGE RANGE Common-Mode Voltage Range Common-Mode Rejection | CMRR | $V_{CM} = -0.1V$ to $4V$ | -0.1 91 | 106 | (V+) -1 | * 86 | * * | V dB |
| INPUT IMPEDANCE Differential Common-Mode | | $V_{CM} = 2.5V$ | | $10^7 \parallel 5$ $10^{10} \parallel 6$ | | * * | | $\Omega \parallel pF$ $\Omega \parallel pF$ |
| OPEN-LOOP GAIN Open-Loop Voltage Gain | A_{OL} | $V_O = 0.25V$ to $4V$ $R_L = 10k\Omega$ $R_L = 2k\Omega$ | 108 86 | 120 96 | | 100 * | * * | dB dB |
| FREQUENCY RESPONSE Gain-Bandwidth Product Slew Rate Settling Time: 0.1% 0.01% Overload Recovery Time | GBW SR | $C_L = 100pF$ $G = 1$, 3V Step, $C_L = 100pF$ $G = 1$, 3V Step, $C_L = 100pF$ (V_{IN}) (Gain) = V_S | 0.35 0.2 15 25 16 | | | * * * * * | | MHz V/ μs μs μs μs |
| OUTPUT Voltage Output: Positive Negative Positive Negative Short-Circuit Current Capacitive Load Drive (Stable Operation) ⁽³⁾ | I_{SC} | $R_L = 10k\Omega$ to $V_S/2$ $R_L = 10k\Omega$ to $V_S/2$ $R_L = 10k\Omega$ to Ground $R_L = 10k\Omega$ to Ground $G = +1$ | (V+) -1 0.25 (V+) -1 0.1 | (V+) -0.65 0.05 (V+) -0.65 0.05 ± 11 1000 | | * * * * * * | * * * * * | V V V V mA pF |
| POWER SUPPLY Specified Operating Voltage Operating Voltage Range Quiescent Current (per amplifier) | I_Q | $I_O = 0$ | +2.7 | +5 250 | +36 300 | * * | * * | V V μA |
| TEMPERATURE RANGE Specified Range Operating Range Storage Thermal Resistance 8-Pin DIP SO-8 Surface-Mount MSOP-8 Surface-Mount 14-Pin DIP SO-14 Surface-Mount | θ_{JA} | | -40 -40 -55 | | +85 +125 +125 | * * * | * * * | $^\circ C$ $^\circ C$ $^\circ C$ $^\circ C/W$ $^\circ C/W$ $^\circ C/W$ $^\circ C/W$ $^\circ C/W$ |

* Specifications same as OPA234U, E.

NOTES: (1) Wafer-level tested to 95% confidence level. (2) Positive conventional current flows into the input terminals. (3) See *Small-Signal Overshoot vs Load Capacitance* typical curve.

ELECTRICAL CHARACTERISTICS: $V_S = +2.7V$

At $T_A = 25^\circ C$, $V_S = +2.7V$, $R_L = 10k\Omega$ connected to $V_S/2$, and $V_{OUT} = V_S/2$, unless otherwise noted.

| PARAMETER | CONDITION | OPA234U, E OPA2234U | | | OPA234UA, EA OPA2234UA OPA4234UA, U | | | UNITS |
|---|---------------|--|------------|-----------------------|---|-----------|-----------|-----------------------|
| | | MIN | TYP | MAX | MIN | TYP | MAX | |
| OFFSET VOLTAGE | | | | | | | | |
| Input Offset Voltage OPA234E, EA | V_{OS} | | ± 40 | ± 100 | | * | ± 250 | μV |
| vs Temperature ⁽¹⁾ | dV_{OS}/dT | | ± 100 | ± 150 | | * | ± 350 | μV |
| vs Power Supply | PSRR | | ± 0.5 | ± 3 | | * | * | $\mu V/^\circ C$ |
| vs Time | | | 3 | 10 | | * | 20 | $\mu V/V$ |
| Channel Separation (Dual, Quad) | | | 0.2 | 0.3 | | * | * | $\mu V/mo$ |
| | | | 0.3 | | | * | * | $\mu V/V$ |
| INPUT BIAS CURRENT | | | | | | | | |
| Input Bias Current ⁽²⁾ | I_B | $V_{CM} = 1.35V$ | -15 | -30 | | * | -50 | nA |
| Input Offset Current | I_{OS} | $V_{CM} = 1.35V$ | ± 1 | ± 5 | | * | * | n |
| NOISE | | $f = 1kHz$ | | | | | | |
| Input Voltage Noise Density | V_n | | 25 | | | * | | nV/\sqrt{Hz} |
| Current Noise Density | i_n | | 80 | | | * | | fA/\sqrt{Hz} |
| INPUT VOLTAGE RANGE | | | | | | | | |
| Common-Mode Voltage Range | | | -0.1 | | $(V+) - 1$ | * | * | V |
| Common-Mode Rejection | CMRR | $V_{CM} = -0.1V$ to $1.7V$ | 91 | 106 | | * | * | dB |
| INPUT IMPEDANCE | | | | | | | | |
| Differential | | $V_{CM} = 1.35V$ | | $10^7 \parallel 5$ | | * | | $\Omega \parallel pF$ |
| Common-Mode | | | | $10^{10} \parallel 6$ | | * | | $\Omega \parallel pF$ |
| OPEN-LOOP GAIN | | | | | | | | |
| Open-Loop Voltage Gain | A_{OL} | $V_O = 0.25V$ to $1.7V$ $R_L = 10k\Omega$ $R_L = 2k\Omega$ | 108 86 | 125 96 | | 100 86 | * | dB dB |
| FREQUENCY RESPONSE | | | | | | | | |
| Gain-Bandwidth Product | GBW | $C_L = 100pF$ | | 0.35 | | | * | MHz |
| Slew Rate | SR | | | 0.2 | | | * | $V/\mu s$ |
| Settling Time: 0.1% | | $G = 1, 1V$ Step, $C_L = 100pF$ | | 6 | | | * | μs |
| 0.01% | | $G = 1, 1V$ Step, $C_L = 100pF$ | | 16 | | | * | μs |
| Overload Recovery Time | | (V_{IN}) (Gain) = V_S | | 8 | | | * | μs |
| OUTPUT | | | | | | | | |
| Voltage Output: Positive | | $R_L = 10k\Omega$ to $V_S/2$ | $(V+) - 1$ | $(V+) - 0.6$ | | * | * | V |
| Negative | | $R_L = 10k\Omega$ to $V_S/2$ | 0.25 | 0.05 | | * | * | V |
| Positive | | $R_L = 10k\Omega$ to Ground | $(V+) - 1$ | $(V+) - 0.65$ | | * | * | V |
| Negative | | $R_L = 10k\Omega$ to Ground | 0.1 | 0.05 | | * | * | V |
| Short-Circuit Current | I_{SC} | | | ± 8 | | * | * | mA |
| Capacitive Load Drive (Stable Operation) ⁽³⁾ | | $G = +1$ | | 1000 | | * | * | pF |
| POWER SUPPLY | | | | | | | | |
| Specified Operating Voltage | | | +2.7 | +2.7 | | * | * | V |
| Operating Voltage Range | | | | | | * | * | V |
| Quiescent Current (per amplifier) | I_Q | $I_Q = 0$ | | 250 | | | * | μA |
| | | | | 300 | | | * | μA |
| TEMPERATURE RANGE | | | | | | | | |
| Specified Range | | | -40 | | +85 | * | * | $^\circ C$ |
| Operating Range | | | -40 | | +125 | * | * | $^\circ C$ |
| Storage | | | -55 | | +125 | * | * | $^\circ C$ |
| Thermal Resistance | θ_{JA} | | | | | | | |
| 8-Pin DIP | | | | 100 | | | * | $^\circ C/W$ |
| SO-8 Surface-Mount | | | | 150 | | | * | $^\circ C/W$ |
| MSOP-8 Surface-Mount | | | | 220 | | | * | $^\circ C/W$ |
| 14-Pin DIP | | | | 80 | | | * | $^\circ C/W$ |
| SO-14 Surface-Mount | | | | 110 | | | * | $^\circ C/W$ |

* Specifications same as OPA234U, E.

NOTES: (1) Wafer-level tested to 95% confidence level. (2) Positive conventional current flows into the input terminals. (3) See *Small-Signal Overshoot vs Load Capacitance* typical curve.

ELECTRICAL CHARACTERISTICS: $V_S = \pm 15V$

At $T_A = 25^\circ C$, $V_S = \pm 15V$, and $R_L = 10k\Omega$ connected to ground, unless otherwise noted.

| PARAMETER | CONDITION | OPA234U, E OPA2234U | | | OPA234UA, EA OPA2234UA OPA4234UA, U | | | UNITS |
|---|--|--|--|---|---|---------------|-----------------------------|--|
| | | MIN | TYP | MAX | MIN | TYP | MAX | |
| OFFSET VOLTAGE | | | | | | | | |
| Input Offset Voltage OPA4234U Model vs Temperature ⁽¹⁾ vs Power Supply vs Time Channel Separation (Dual, Quad) | V_{OS} dV_{OS}/dT $PSRR$ | $V_{CM} = 0V$ Operating Temperature Range $V_S = \pm 1.35V$ to $\pm 18V$, $V_{CM} = 0V$ | ± 70 ± 0.5 3 0.2 0.3 | ± 250 ± 5 10 | * | ± 70 * | ± 500 ± 250 * | μV μV $\mu V/^\circ C$ $\mu V/V$ $\mu V/mo$ $\mu V/V$ |
| INPUT BIAS CURRENT | | | | | | | | |
| Input Bias Current ⁽²⁾ Input Offset Current | I_B I_{OS} | $V_{CM} = 0V$ $V_{CM} = 0V$ | -12 ± 1 | -25 ± 5 | * | * | -50 * | nA nA |
| NOISE | | | | | | | | |
| Input Voltage Noise Density Current Noise Density | V_n i_n | $f = 1kHz$ | 25 80 | | * | * | | nV/\sqrt{Hz} fA/\sqrt{Hz} |
| INPUT VOLTAGE RANGE | | | | | | | | |
| Common-Mode Voltage Range Common-Mode Rejection | CMRR | $V_{CM} = -15V$ to $14V$ | (V-) 91 | 106 | (V+) -1 | * | * | V dB |
| INPUT IMPEDANCE | | | | | | | | |
| Differential Common-Mode | | $V_{CM} = 0V$ | | $10^7 \parallel 5$ $10^{10} \parallel 6$ | | * | * | $\Omega \parallel pF$ $\Omega \parallel pF$ |
| OPEN-LOOP GAIN | | | | | | | | |
| Open-Loop Voltage Gain | A_{OL} | $V_O = -14.5V$ to $14V$ | 110 | 120 | | * | | dB |
| FREQUENCY RESPONSE | | | | | | | | |
| Gain-Bandwidth Product Slew Rate Settling Time: 0.1% 0.01% Overload Recovery Time | GBW SR | $C_L = 100pF$ $G = 1$, 10V Step, $C_L = 100pF$ $G = 1$, 10V Step, $C_L = 100pF$ (V_{IN}) (Gain) = V_S | | 0.35 0.2 41 47 22 | | * | * | MHz V/ μs μs μs μs |
| OUTPUT | | | | | | | | |
| Voltage Output: Positive Negative Short-Circuit Current Capacitive Load Drive (Stable Operation) ⁽³⁾ | I_{SC} | $G = +1$ | (V+) -1 (V-) +0.5 | (V+) -0.7 (V-) +0.15 ± 22 1000 | * | * | * | V V mA pF |
| POWER SUPPLY | | | | | | | | |
| Specified Operating Voltage Operating Voltage Range Quiescent Current (per amplifier) | I_Q | $I_O = 0$ | ± 1.35 | ± 15 ± 275 | ± 18 ± 350 | * | * | V V μA |
| TEMPERATURE RANGE | | | | | | | | |
| Specified Range Operating Range Storage Thermal Resistance 8-Pin DIP SO-8 Surface-Mount MSOP-8 Surface-Mount 14-Pin DIP SO-14 Surface-Mount | θ_{JA} | | -40 -40 -55 | | +85 +125 +125 | * | * | $^\circ C$ $^\circ C$ $^\circ C$ $^\circ C/W$ $^\circ C/W$ $^\circ C/W$ $^\circ C/W$ $^\circ C/W$ |

* Specifications same as OPA234U, E.

NOTES: (1) Wafer-level tested to 95% confidence level. (2) Positive conventional current flows into the input terminals. (3) See *Small-Signal Overshoot vs Load Capacitance* typical curve.



ELECTROSTATIC DISCHARGE SENSITIVITY

This integrated circuit can be damaged by ESD. Texas Instruments recommends that all integrated circuits be handled with appropriate precautions. Failure to observe proper handling and installation procedures can cause damage.

ESD damage can range from subtle performance degradation to complete device failure. Precision integrated circuits may be more susceptible to damage because very small parametric changes could cause the device not to meet its published specifications.

ABSOLUTE MAXIMUM RATINGS

| | |
|---|--------------------------|
| Supply Voltage, V+ to V- | 36V |
| Input Voltage | (V-) -0.7V to (V+) +0.7V |
| Output Short-Circuit ⁽¹⁾ | Continuous |
| Operating Temperature | -40°C to +125°C |
| Storage Temperature | -55°C to +125°C |
| Junction Temperature | 150°C |
| Lead Temperature (soldering, 10s) | 300°C |

NOTE: (1) Short-circuit to ground, one amplifier per package.

PACKAGE INFORMATION

| PRODUCT | PACKAGE | PACKAGE MARKING |
|---|--|---------------------------------|
| Single OPA234EA OPA234E OPA234UA OPA234U | MSOP-8 Surface-Mount " SO-8 Surface-Mount " | A34 " OPA234UA OPA234U |
| Dual OPA2234UA OPA2234U | SO-8 Surface-Mount " | OPA2234UA OPA2234U |
| Quad OPA4234UA OPA4234U | SO-8 Surface-Mount " | OPA4234UA OPA4234U |

NOTE: (1) For the most current package and ordering information, see the Package Option Addendum located at the end of this data sheet.

TYPICAL CHARACTERISTIC CURVES

At $T_A = +25^\circ\text{C}$ and $R_L = 10\text{k}\Omega$, unless otherwise noted.

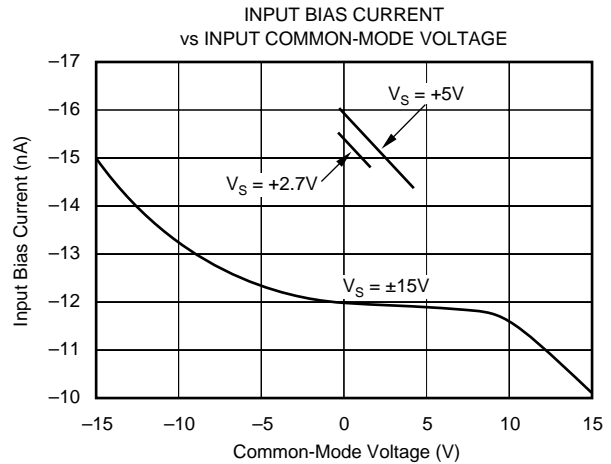
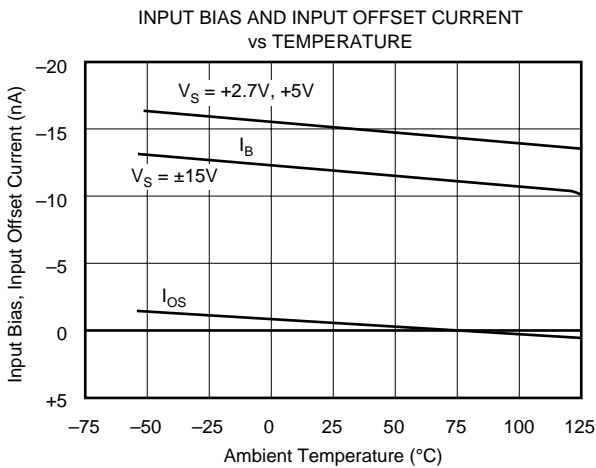
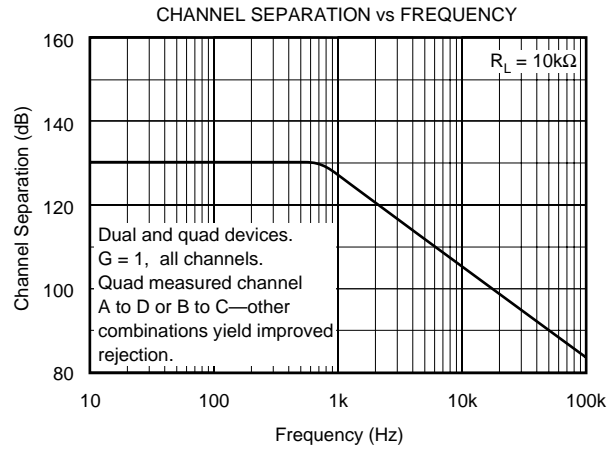
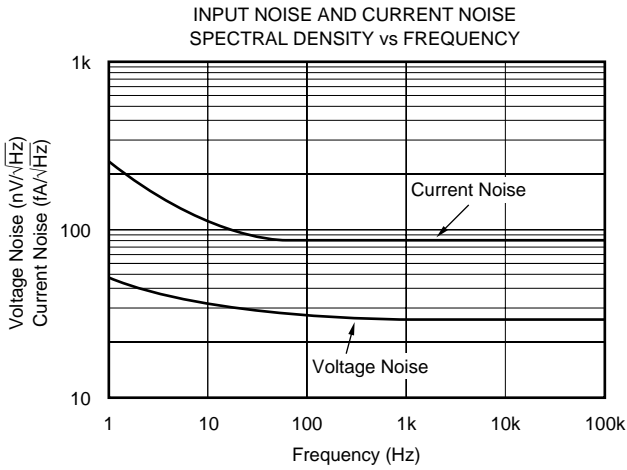
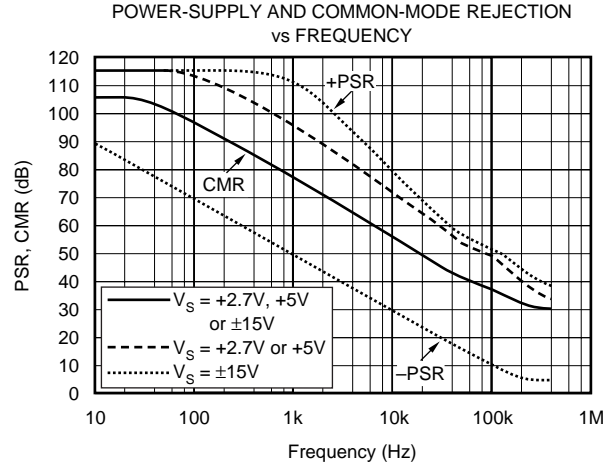
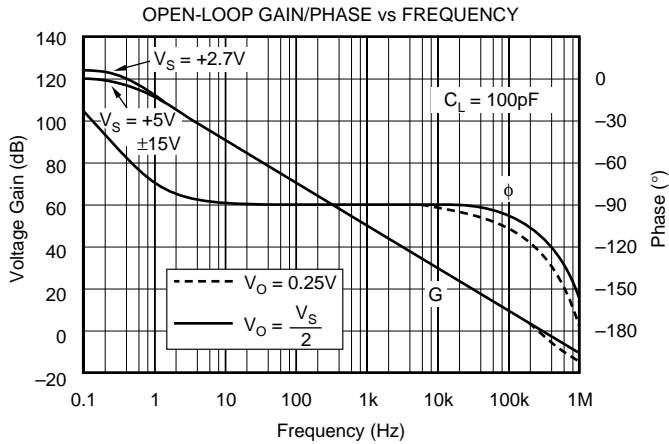

TYPICAL CHARACTERISTIC CURVES (Cont.)

At $T_A = +25^\circ\text{C}$ and $R_L = 10\text{k}\Omega$, unless otherwise noted.

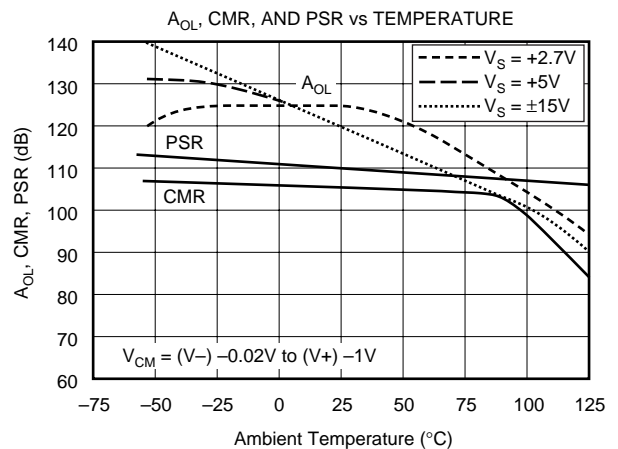
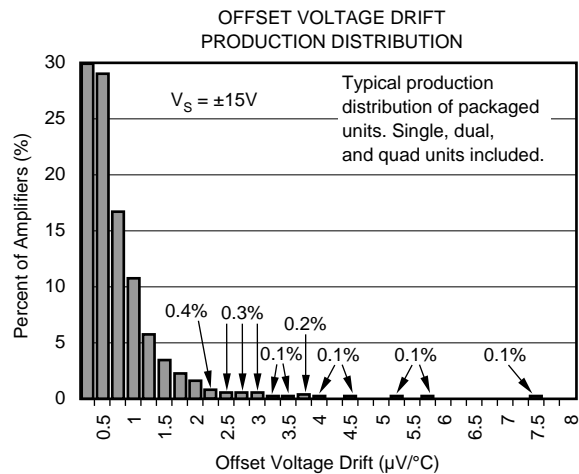
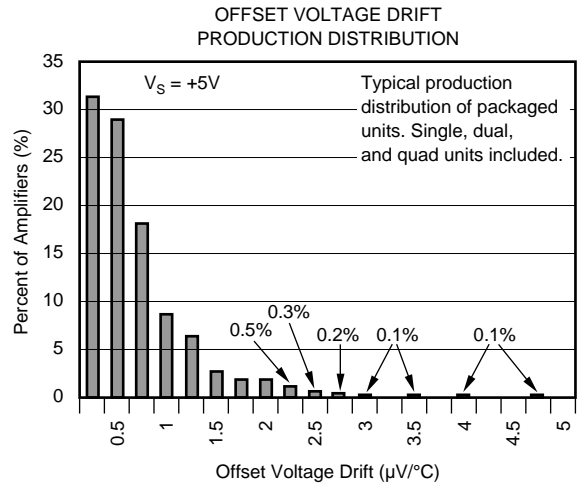
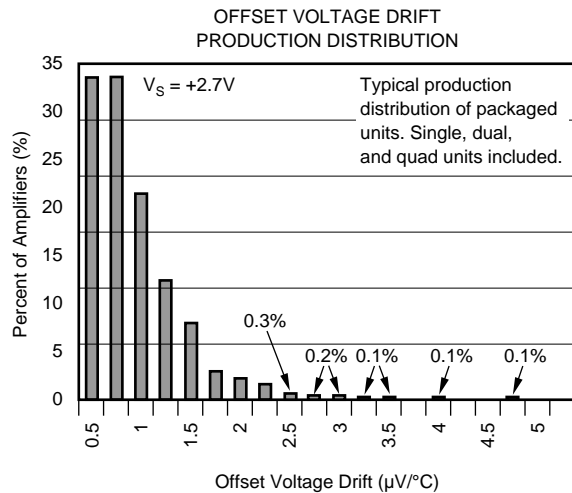
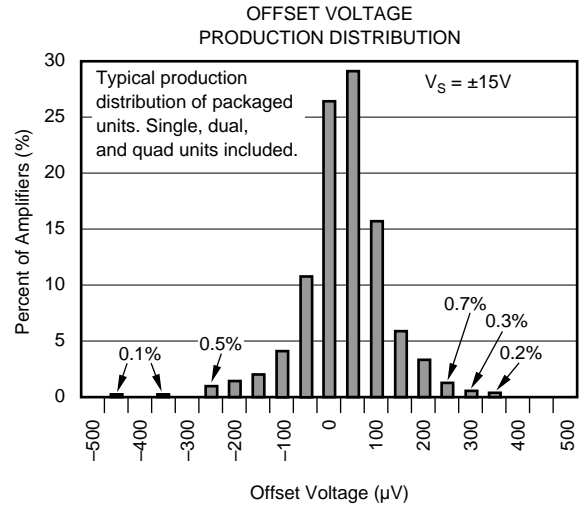
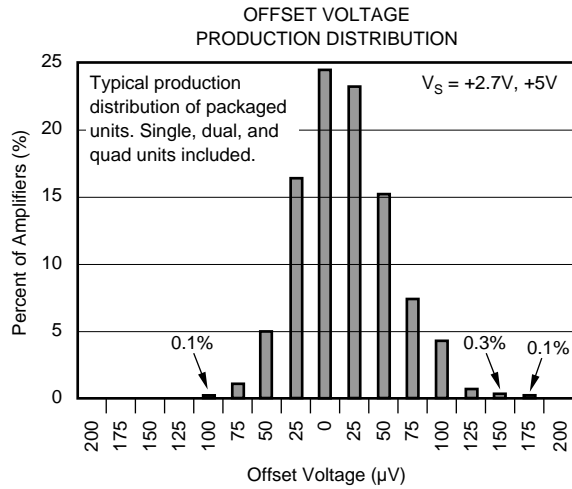

TYPICAL CHARACTERISTIC CURVES (Cont.)

At $T_A = +25^\circ\text{C}$ and $R_L = 10\text{k}\Omega$, unless otherwise noted.

SMALL-SIGNAL STEP RESPONSE
 $G = 1, C_L = 100\text{pF}, V_S = +5\text{V}$

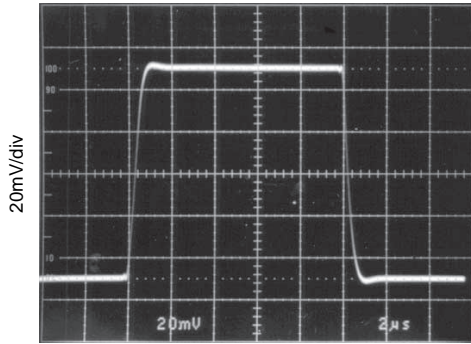

SMALL-SIGNAL STEP RESPONSE
 $G = 1, C_L = 10,000\text{pF}, V_S = +5\text{V}$

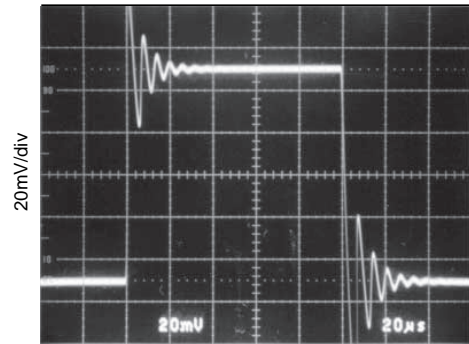

LARGE-SIGNAL STEP RESPONSE
 $G = 1, C_L = 100\text{pF}, V_S = +5\text{V}$

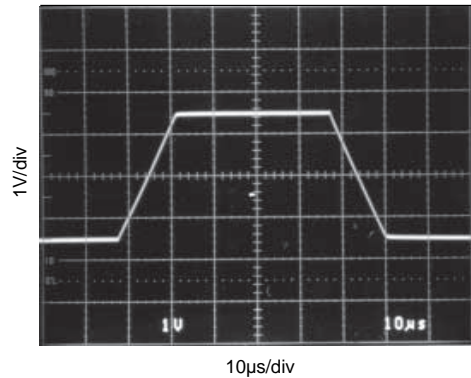

SETTLING TIME vs CLOSED-LOOP GAIN

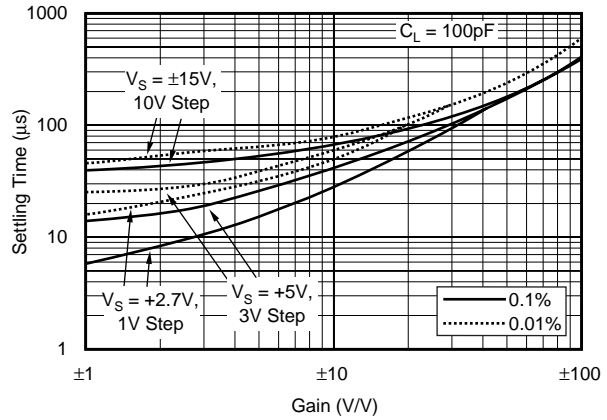

OUTPUT VOLTAGE SWING vs OUTPUT CURRENT

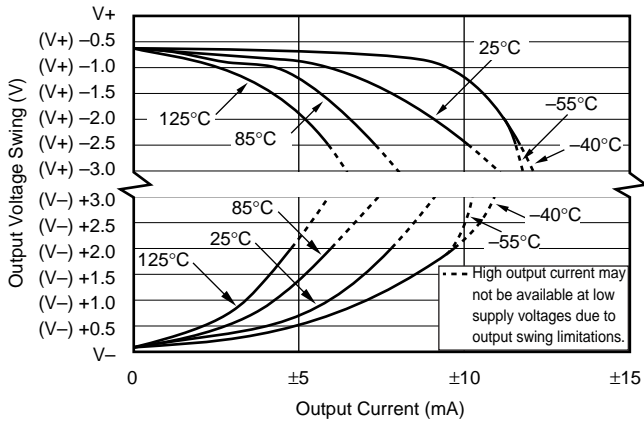

SMALL-SIGNAL OVERSHOOT vs LOAD CAPACITANCE

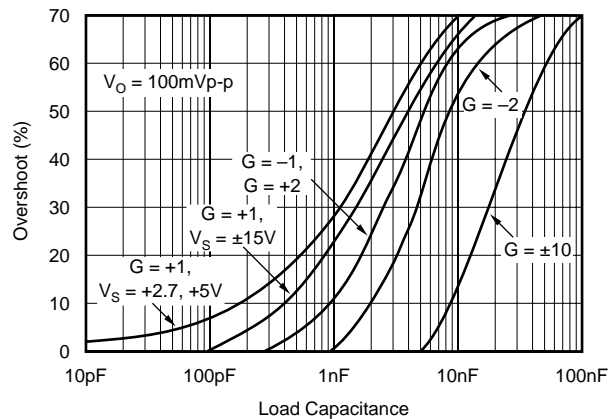

TYPICAL CHARACTERISTIC CURVES (Cont.)

At $T_A = +25^\circ\text{C}$ and $R_L = 10\text{k}\Omega$, unless otherwise noted.

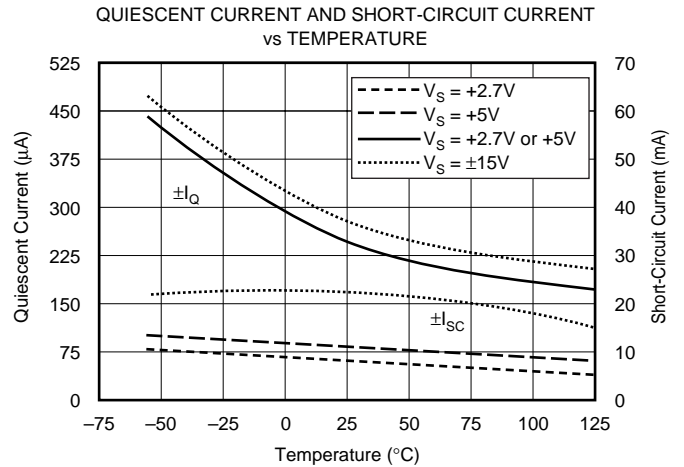
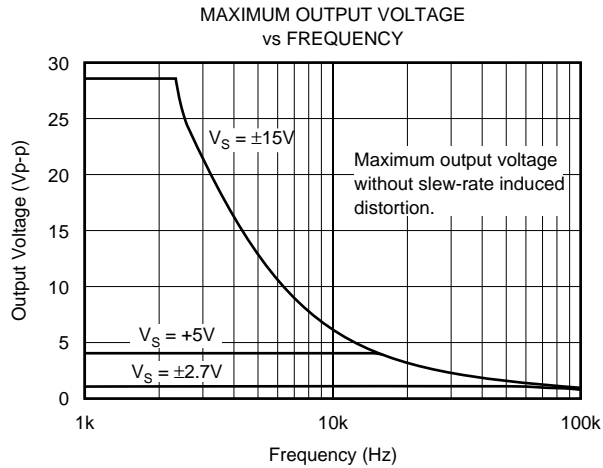

APPLICATIONS INFORMATION

The OPA234 series op amps are unity-gain stable and suitable for a wide range of general-purpose applications. Power-supply pins should be bypassed with 10nF ceramic capacitors.

OPERATING VOLTAGE

The OPA234 series op amps operate from single (+2.7V to +36V) or dual ($\pm 1.35\text{V}$ to $\pm 18\text{V}$) supplies with excellent performance. Specifications are production tested with +2.7V, +5V, and $\pm 15\text{V}$ supplies. Most behavior remains unchanged throughout the full operating voltage range. Parameters which vary significantly with operating voltage are shown in the Typical Characteristic curves.

OFFSET VOLTAGE TRIM

Offset voltage of the OPA234 series amplifiers is laser trimmed and usually requires no user adjustment. The OPA234 (single op amp version) provides offset voltage trim connections on pins 1 and 5. Offset voltage can be adjusted by connecting a potentiometer, as shown in Figure 1. This adjustment should be used only to null the offset of the op amp, not to adjust system offset or offset produced by the signal source. Nulling offset could degrade the offset drift behavior of the op amp. While it is not possible to predict the exact change in drift, the effect is usually small.

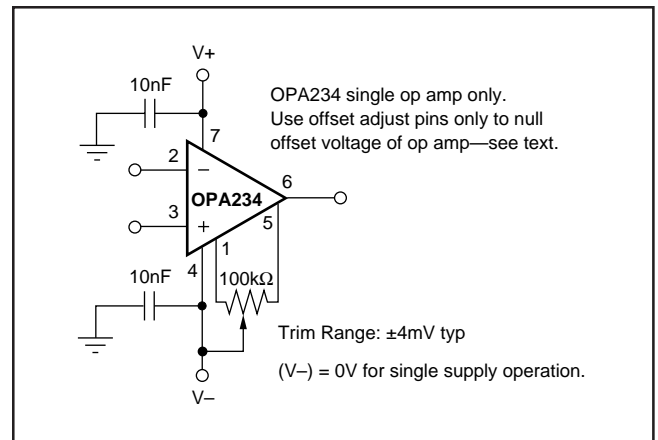

FIGURE 1. OPA234 Offset Voltage Trim Circuit.

PACKAGING INFORMATION

| Orderable Device | Status (1) | Package Type | Package Drawing | Pins | Package Qty | Eco Plan (2) | Lead/Ball Finish (6) | MSL Peak Temp (3) | Op Temp (°C) | Device Marking (4/5) | Samples |
|------------------|---------------|--------------|-----------------|------|-------------|-------------------------|-------------------------|----------------------|--------------|-------------------------|-------------------------|
| OPA2234U | ACTIVE | SOIC | D | 8 | 75 | Green (RoHS & no Sb/Br) | CU NIPDAU-DCC | Level-3-260C-168 HR | -40 to 85 | OPA 2234U | Samples |
| OPA2234U/2K5 | ACTIVE | SOIC | D | 8 | 2500 | Green (RoHS & no Sb/Br) | CU NIPDAU-DCC | Level-3-260C-168 HR | -40 to 85 | OPA 2234U | Samples |
| OPA2234U/2K5G4 | ACTIVE | SOIC | D | 8 | 2500 | Green (RoHS & no Sb/Br) | CU NIPDAU-DCC | Level-3-260C-168 HR | -40 to 85 | OPA 2234U | Samples |
| OPA2234UA | ACTIVE | SOIC | D | 8 | 75 | Green (RoHS & no Sb/Br) | CU NIPDAU-DCC | Level-3-260C-168 HR | -40 to 85 | OPA 2234U A | Samples |
| OPA2234UA/2K5 | ACTIVE | SOIC | D | 8 | 2500 | Green (RoHS & no Sb/Br) | CU NIPDAU-DCC | Level-3-260C-168 HR | -40 to 85 | OPA 2234U A | Samples |
| OPA2234UA/2K5G4 | ACTIVE | SOIC | D | 8 | 2500 | Green (RoHS & no Sb/Br) | CU NIPDAU-DCC | Level-3-260C-168 HR | -40 to 85 | OPA 2234U A | Samples |
| OPA2234UAG4 | ACTIVE | SOIC | D | 8 | 75 | Green (RoHS & no Sb/Br) | CU NIPDAU-DCC | Level-3-260C-168 HR | -40 to 85 | OPA 2234U A | Samples |
| OPA2234UG4 | ACTIVE | SOIC | D | 8 | 75 | Green (RoHS & no Sb/Br) | CU NIPDAU-DCC | Level-3-260C-168 HR | -40 to 85 | OPA 2234U | Samples |
| OPA234E/250 | ACTIVE | VSSOP | DGK | 8 | 250 | Green (RoHS & no Sb/Br) | CU NIPDAU Call TI | Level-3-260C-168 HR | -40 to 125 | A34 | Samples |
| OPA234E/250G4 | ACTIVE | VSSOP | DGK | 8 | 250 | Green (RoHS & no Sb/Br) | Call TI | Level-3-260C-168 HR | -40 to 125 | A34 | Samples |
| OPA234E/2K5 | ACTIVE | VSSOP | DGK | 8 | 2500 | Green (RoHS & no Sb/Br) | CU NIPDAU Call TI | Level-3-260C-168 HR | -40 to 125 | A34 | Samples |
| OPA234EA/250 | ACTIVE | VSSOP | DGK | 8 | 250 | Green (RoHS & no Sb/Br) | CU NIPDAU Call TI | Level-3-260C-168 HR | -40 to 125 | A34 | Samples |
| OPA234EA/250G4 | ACTIVE | VSSOP | DGK | 8 | 250 | Green (RoHS & no Sb/Br) | Call TI | Level-3-260C-168 HR | -40 to 125 | A34 | Samples |
| OPA234EA/2K5 | ACTIVE | VSSOP | DGK | 8 | 2500 | Green (RoHS & no Sb/Br) | CU NIPDAU Call TI | Level-3-260C-168 HR | -40 to 125 | A34 | Samples |
| OPA234U | ACTIVE | SOIC | D | 8 | 75 | Green (RoHS & no Sb/Br) | CU NIPDAU-DCC | Level-3-260C-168 HR | -40 to 125 | OPA 234U | Samples |

| Orderable Device | Status (1) | Package Type | Package Drawing | Pins | Package Qty | Eco Plan (2) | Lead/Ball Finish (6) | MSL Peak Temp (3) | Op Temp (°C) | Device Marking (4/5) | Samples |
|------------------|---------------|--------------|-----------------|------|-------------|-------------------------|-------------------------|----------------------|--------------|-------------------------|-------------------------|
| OPA234U/2K5 | ACTIVE | SOIC | D | 8 | 2500 | Green (RoHS & no Sb/Br) | CU NIPDAU-DCC | Level-3-260C-168 HR | -40 to 125 | OPA 234U | Samples |
| OPA234UA | ACTIVE | SOIC | D | 8 | 75 | Green (RoHS & no Sb/Br) | CU NIPDAU-DCC | Level-3-260C-168 HR | -40 to 125 | OPA 234U A | Samples |
| OPA234UA/2K5 | ACTIVE | SOIC | D | 8 | 2500 | Green (RoHS & no Sb/Br) | CU NIPDAU-DCC | Level-3-260C-168 HR | -40 to 125 | OPA 234U A | Samples |
| OPA234UA/2K5G4 | ACTIVE | SOIC | D | 8 | 2500 | Green (RoHS & no Sb/Br) | CU NIPDAU-DCC | Level-3-260C-168 HR | -40 to 125 | OPA 234U A | Samples |
| OPA234UG4 | ACTIVE | SOIC | D | 8 | 75 | Green (RoHS & no Sb/Br) | CU NIPDAU-DCC | Level-3-260C-168 HR | -40 to 125 | OPA 234U | Samples |
| OPA4234U | ACTIVE | SOIC | D | 14 | 50 | Green (RoHS & no Sb/Br) | CU NIPDAU-DCC | Level-3-260C-168 HR | -40 to 85 | OPA4234U | Samples |
| OPA4234U/2K5 | ACTIVE | SOIC | D | 14 | 2500 | Green (RoHS & no Sb/Br) | CU NIPDAU-DCC | Level-3-260C-168 HR | -40 to 85 | OPA4234U | Samples |
| OPA4234UA | ACTIVE | SOIC | D | 14 | 50 | Green (RoHS & no Sb/Br) | CU NIPDAU-DCC | Level-3-260C-168 HR | -40 to 85 | OPA4234U A | Samples |
| OPA4234UA/2K5 | ACTIVE | SOIC | D | 14 | 2500 | Green (RoHS & no Sb/Br) | CU NIPDAU-DCC | Level-3-260C-168 HR | -40 to 85 | OPA4234U A | Samples |
| OPA4234UA/2K5G4 | ACTIVE | SOIC | D | 14 | 2500 | Green (RoHS & no Sb/Br) | CU NIPDAU-DCC | Level-3-260C-168 HR | -40 to 85 | OPA4234U A | Samples |
| OPA4234UAG4 | ACTIVE | SOIC | D | 14 | 50 | Green (RoHS & no Sb/Br) | CU NIPDAU-DCC | Level-3-260C-168 HR | -40 to 85 | OPA4234U A | Samples |
| OPA4234UG4 | ACTIVE | SOIC | D | 14 | 50 | Green (RoHS & no Sb/Br) | CU NIPDAU-DCC | Level-3-260C-168 HR | -40 to 85 | OPA4234U | Samples |

(1) The marketing status values are defined as follows:

ACTIVE: Product device recommended for new designs.

LIFEBUY: TI has announced that the device will be discontinued, and a lifetime-buy period is in effect.

NRND: Not recommended for new designs. Device is in production to support existing customers, but TI does not recommend using this part in a new design.

PREVIEW: Device has been announced but is not in production. Samples may or may not be available.

OBSOLETE: TI has discontinued the production of the device.

(2) **RoHS:** TI defines "RoHS" to mean semiconductor products that are compliant with the current EU RoHS requirements for all 10 RoHS substances, including the requirement that RoHS substance do not exceed 0.1% by weight in homogeneous materials. Where designed to be soldered at high temperatures, "RoHS" products are suitable for use in specified lead-free processes. TI may reference these types of products as "Pb-Free".

RoHS Exempt: TI defines "RoHS Exempt" to mean products that contain lead but are compliant with EU RoHS pursuant to a specific EU RoHS exemption.

Green: TI defines "Green" to mean the content of Chlorine (Cl) and Bromine (Br) based flame retardants meet JS709B low halogen requirements of <=1000ppm threshold. Antimony trioxide based flame retardants must also meet the <=1000ppm threshold requirement.

(3) MSL, Peak Temp. - The Moisture Sensitivity Level rating according to the JEDEC industry standard classifications, and peak solder temperature.

(4) There may be additional marking, which relates to the logo, the lot trace code information, or the environmental category on the device.

(5) Multiple Device Markings will be inside parentheses. Only one Device Marking contained in parentheses and separated by a "~" will appear on a device. If a line is indented then it is a continuation of the previous line and the two combined represent the entire Device Marking for that device.

(6) Lead/Ball Finish - Orderable Devices may have multiple material finish options. Finish options are separated by a vertical ruled line. Lead/Ball Finish values may wrap to two lines if the finish value exceeds the maximum column width.

Important Information and Disclaimer: The information provided on this page represents TI's knowledge and belief as of the date that it is provided. TI bases its knowledge and belief on information provided by third parties, and makes no representation or warranty as to the accuracy of such information. Efforts are underway to better integrate information from third parties. TI has taken and continues to take reasonable steps to provide representative and accurate information but may not have conducted destructive testing or chemical analysis on incoming materials and chemicals. TI and TI suppliers consider certain information to be proprietary, and thus CAS numbers and other limited information may not be available for release.

In no event shall TI's liability arising out of such information exceed the total purchase price of the TI part(s) at issue in this document sold by TI to Customer on an annual basis.

OTHER QUALIFIED VERSIONS OF OPA2234 :

- Military: [OPA2234M](#)

NOTE: Qualified Version Definitions:

- Military - QML certified for Military and Defense Applications

TAPE AND REEL INFORMATION



QUADRANT ASSIGNMENTS FOR PIN 1 ORIENTATION IN TAPE



*All dimensions are nominal

| Device | Package Type | Package Drawing | Pins | SPQ | Reel Diameter (mm) | Reel Width W1 (mm) | A0 (mm) | B0 (mm) | K0 (mm) | P1 (mm) | W (mm) | Pin1 Quadrant |
|---------------|--------------|-----------------|------|------|--------------------|--------------------|---------|---------|---------|---------|--------|---------------|
| OPA2234U/2K5 | SOIC | D | 8 | 2500 | 330.0 | 12.4 | 6.4 | 5.2 | 2.1 | 8.0 | 12.0 | Q1 |
| OPA2234UA/2K5 | SOIC | D | 8 | 2500 | 330.0 | 12.4 | 6.4 | 5.2 | 2.1 | 8.0 | 12.0 | Q1 |
| OPA234E/250 | VSSOP | DGK | 8 | 250 | 180.0 | 12.4 | 5.3 | 3.4 | 1.4 | 8.0 | 12.0 | Q1 |
| OPA234E/2K5 | VSSOP | DGK | 8 | 2500 | 330.0 | 12.4 | 5.3 | 3.4 | 1.4 | 8.0 | 12.0 | Q1 |
| OPA234EA/250 | VSSOP | DGK | 8 | 250 | 180.0 | 12.4 | 5.3 | 3.4 | 1.4 | 8.0 | 12.0 | Q1 |
| OPA234EA/2K5 | VSSOP | DGK | 8 | 2500 | 330.0 | 12.4 | 5.3 | 3.4 | 1.4 | 8.0 | 12.0 | Q1 |
| OPA234U/2K5 | SOIC | D | 8 | 2500 | 330.0 | 12.4 | 6.4 | 5.2 | 2.1 | 8.0 | 12.0 | Q1 |
| OPA234UA/2K5 | SOIC | D | 8 | 2500 | 330.0 | 12.4 | 6.4 | 5.2 | 2.1 | 8.0 | 12.0 | Q1 |
| OPA4234U/2K5 | SOIC | D | 14 | 2500 | 330.0 | 16.4 | 6.5 | 9.0 | 2.1 | 8.0 | 16.0 | Q1 |
| OPA4234UA/2K5 | SOIC | D | 14 | 2500 | 330.0 | 16.4 | 6.5 | 9.0 | 2.1 | 8.0 | 16.0 | Q1 |

TAPE AND REEL BOX DIMENSIONS



*All dimensions are nominal

| Device | Package Type | Package Drawing | Pins | SPQ | Length (mm) | Width (mm) | Height (mm) |
|---------------|--------------|-----------------|------|------|-------------|------------|-------------|
| OPA2234U/2K5 | SOIC | D | 8 | 2500 | 367.0 | 367.0 | 35.0 |
| OPA2234UA/2K5 | SOIC | D | 8 | 2500 | 367.0 | 367.0 | 35.0 |
| OPA234E/250 | VSSOP | DGK | 8 | 250 | 210.0 | 185.0 | 35.0 |
| OPA234E/2K5 | VSSOP | DGK | 8 | 2500 | 367.0 | 367.0 | 35.0 |
| OPA234EA/250 | VSSOP | DGK | 8 | 250 | 210.0 | 185.0 | 35.0 |
| OPA234EA/2K5 | VSSOP | DGK | 8 | 2500 | 367.0 | 367.0 | 35.0 |
| OPA234U/2K5 | SOIC | D | 8 | 2500 | 367.0 | 367.0 | 35.0 |
| OPA234UA/2K5 | SOIC | D | 8 | 2500 | 367.0 | 367.0 | 35.0 |
| OPA4234U/2K5 | SOIC | D | 14 | 2500 | 367.0 | 367.0 | 38.0 |
| OPA4234UA/2K5 | SOIC | D | 14 | 2500 | 367.0 | 367.0 | 38.0 |

D (R-PDSO-G14)

PLASTIC SMALL OUTLINE



- NOTES:
- A. All linear dimensions are in inches (millimeters).
 - B. This drawing is subject to change without notice.
 -  Body length does not include mold flash, protrusions, or gate burrs. Mold flash, protrusions, or gate burrs shall not exceed 0.006 (0,15) each side.
 -  Body width does not include interlead flash. Interlead flash shall not exceed 0.017 (0,43) each side.
 - E. Reference JEDEC MS-012 variation AB.

D (R-PDSO-G14)

PLASTIC SMALL OUTLINE





- NOTES:
- A. All linear dimensions are in millimeters.
 - B. This drawing is subject to change without notice.
 - C. Publication IPC-7351 is recommended for alternate designs.
 - D. Laser cutting apertures with trapezoidal walls and also rounding corners will offer better paste release. Customers should contact their board assembly site for stencil design recommendations. Refer to IPC-7525 for other stencil recommendations.
 - E. Customers should contact their board fabrication site for solder mask tolerances between and around signal pads.

D (R-PDSO-G8)

PLASTIC SMALL OUTLINE



- NOTES:
- A. All linear dimensions are in inches (millimeters).
 - B. This drawing is subject to change without notice.
 -  Body length does not include mold flash, protrusions, or gate burrs. Mold flash, protrusions, or gate burrs shall not exceed 0.006 (0,15) each side.
 -  Body width does not include interlead flash. Interlead flash shall not exceed 0.017 (0,43) each side.
 - E. Reference JEDEC MS-012 variation AA.

D (R-PDSO-G8)

PLASTIC SMALL OUTLINE



- NOTES:
- A. All linear dimensions are in millimeters.
 - B. This drawing is subject to change without notice.
 - C. Publication IPC-7351 is recommended for alternate designs.
 - D. Laser cutting apertures with trapezoidal walls and also rounding corners will offer better paste release. Customers should contact their board assembly site for stencil design recommendations. Refer to IPC-7525 for other stencil recommendations.
 - E. Customers should contact their board fabrication site for solder mask tolerances between and around signal pads.

DGK (S-PDSO-G8)

PLASTIC SMALL-OUTLINE PACKAGE

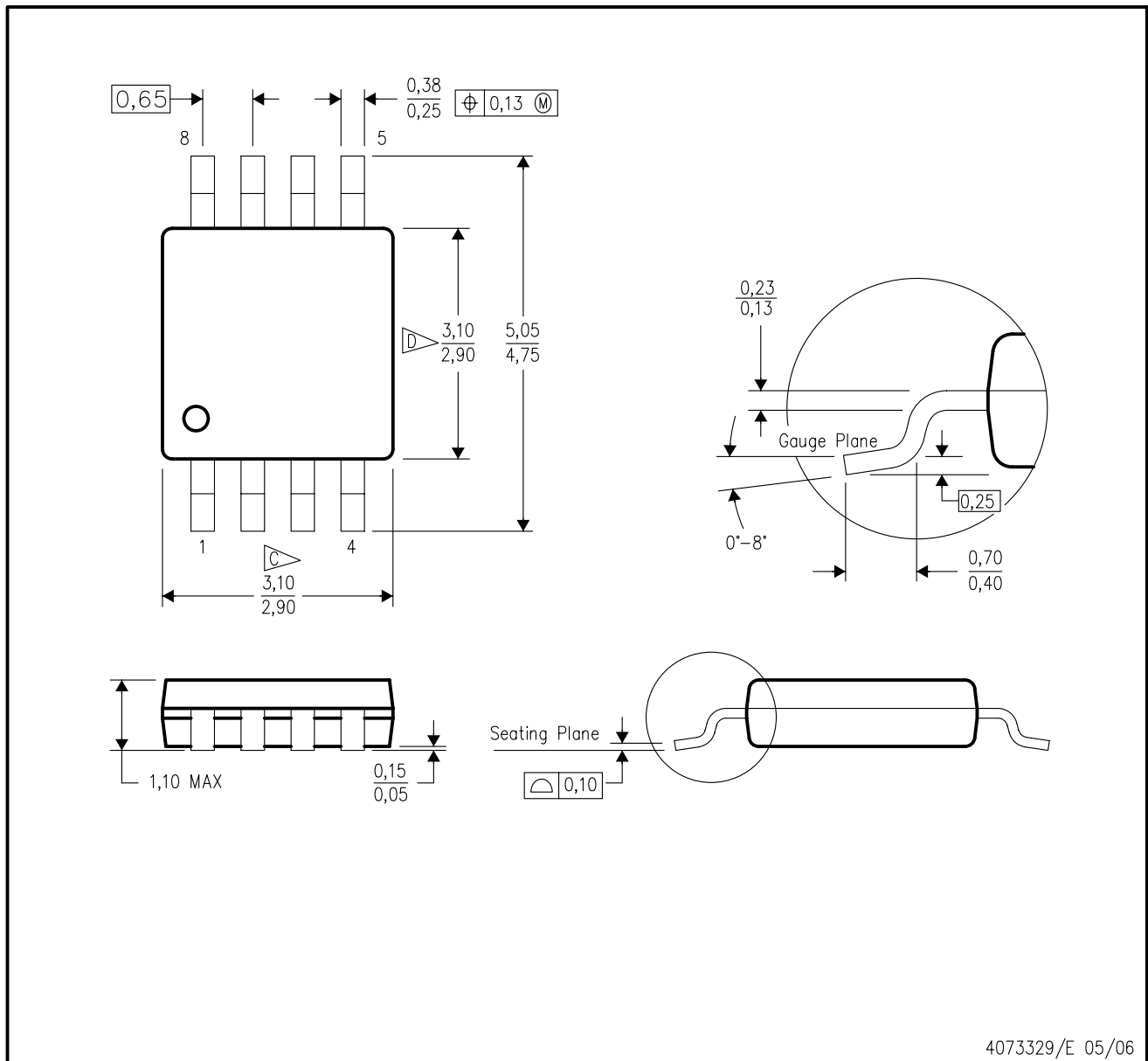

- NOTES:
- A. All linear dimensions are in millimeters.
 - B. This drawing is subject to change without notice.
 - C. Body length does not include mold flash, protrusions, or gate burrs. Mold flash, protrusions, or gate burrs shall not exceed 0.15 per end.
 - D. Body width does not include interlead flash. Interlead flash shall not exceed 0.50 per side.
 - E. Falls within JEDEC MO-187 variation AA, except interlead flash.

IMPORTANT NOTICE

Texas Instruments Incorporated (TI) reserves the right to make corrections, enhancements, improvements and other changes to its semiconductor products and services per JESD46, latest issue, and to discontinue any product or service per JESD48, latest issue. Buyers should obtain the latest relevant information before placing orders and should verify that such information is current and complete.

TI's published terms of sale for semiconductor products (<http://www.ti.com/sc/docs/stdterms.htm>) apply to the sale of packaged integrated circuit products that TI has qualified and released to market. Additional terms may apply to the use or sale of other types of TI products and services.

Reproduction of significant portions of TI information in TI data sheets is permissible only if reproduction is without alteration and is accompanied by all associated warranties, conditions, limitations, and notices. TI is not responsible or liable for such reproduced documentation. Information of third parties may be subject to additional restrictions. Resale of TI products or services with statements different from or beyond the parameters stated by TI for that product or service voids all express and any implied warranties for the associated TI product or service and is an unfair and deceptive business practice. TI is not responsible or liable for any such statements.

Buyers and others who are developing systems that incorporate TI products (collectively, "Designers") understand and agree that Designers remain responsible for using their independent analysis, evaluation and judgment in designing their applications and that Designers have full and exclusive responsibility to assure the safety of Designers' applications and compliance of their applications (and of all TI products used in or for Designers' applications) with all applicable regulations, laws and other applicable requirements. Designer represents that, with respect to their applications, Designer has all the necessary expertise to create and implement safeguards that (1) anticipate dangerous consequences of failures, (2) monitor failures and their consequences, and (3) lessen the likelihood of failures that might cause harm and take appropriate actions. Designer agrees that prior to using or distributing any applications that include TI products, Designer will thoroughly test such applications and the functionality of such TI products as used in such applications.

TI's provision of technical, application or other design advice, quality characterization, reliability data or other services or information, including, but not limited to, reference designs and materials relating to evaluation modules, (collectively, "TI Resources") are intended to assist designers who are developing applications that incorporate TI products; by downloading, accessing or using TI Resources in any way, Designer (individually or, if Designer is acting on behalf of a company, Designer's company) agrees to use any particular TI Resource solely for this purpose and subject to the terms of this Notice.

TI's provision of TI Resources does not expand or otherwise alter TI's applicable published warranties or warranty disclaimers for TI products, and no additional obligations or liabilities arise from TI providing such TI Resources. TI reserves the right to make corrections, enhancements, improvements and other changes to its TI Resources. TI has not conducted any testing other than that specifically described in the published documentation for a particular TI Resource.

Designer is authorized to use, copy and modify any individual TI Resource only in connection with the development of applications that include the TI product(s) identified in such TI Resource. NO OTHER LICENSE, EXPRESS OR IMPLIED, BY ESTOPPEL OR OTHERWISE TO ANY OTHER TI INTELLECTUAL PROPERTY RIGHT, AND NO LICENSE TO ANY TECHNOLOGY OR INTELLECTUAL PROPERTY RIGHT OF TI OR ANY THIRD PARTY IS GRANTED HEREIN, including but not limited to any patent right, copyright, mask work right, or other intellectual property right relating to any combination, machine, or process in which TI products or services are used. Information regarding or referencing third-party products or services does not constitute a license to use such products or services, or a warranty or endorsement thereof. Use of TI Resources may require a license from a third party under the patents or other intellectual property of the third party, or a license from TI under the patents or other intellectual property of TI.

TI RESOURCES ARE PROVIDED "AS IS" AND WITH ALL FAULTS. TI DISCLAIMS ALL OTHER WARRANTIES OR REPRESENTATIONS, EXPRESS OR IMPLIED, REGARDING RESOURCES OR USE THEREOF, INCLUDING BUT NOT LIMITED TO ACCURACY OR COMPLETENESS, TITLE, ANY EPIDEMIC FAILURE WARRANTY AND ANY IMPLIED WARRANTIES OF MERCHANTABILITY, FITNESS FOR A PARTICULAR PURPOSE, AND NON-INFRINGEMENT OF ANY THIRD PARTY INTELLECTUAL PROPERTY RIGHTS. TI SHALL NOT BE LIABLE FOR AND SHALL NOT DEFEND OR INDEMNIFY DESIGNER AGAINST ANY CLAIM, INCLUDING BUT NOT LIMITED TO ANY INFRINGEMENT CLAIM THAT RELATES TO OR IS BASED ON ANY COMBINATION OF PRODUCTS EVEN IF DESCRIBED IN TI RESOURCES OR OTHERWISE. IN NO EVENT SHALL TI BE LIABLE FOR ANY ACTUAL, DIRECT, SPECIAL, COLLATERAL, INDIRECT, PUNITIVE, INCIDENTAL, CONSEQUENTIAL OR EXEMPLARY DAMAGES IN CONNECTION WITH OR ARISING OUT OF TI RESOURCES OR USE THEREOF, AND REGARDLESS OF WHETHER TI HAS BEEN ADVISED OF THE POSSIBILITY OF SUCH DAMAGES.

Unless TI has explicitly designated an individual product as meeting the requirements of a particular industry standard (e.g., ISO/TS 16949 and ISO 26262), TI is not responsible for any failure to meet such industry standard requirements.

Where TI specifically promotes products as facilitating functional safety or as compliant with industry functional safety standards, such products are intended to help enable customers to design and create their own applications that meet applicable functional safety standards and requirements. Using products in an application does not by itself establish any safety features in the application. Designers must ensure compliance with safety-related requirements and standards applicable to their applications. Designer may not use any TI products in life-critical medical equipment unless authorized officers of the parties have executed a special contract specifically governing such use. Life-critical medical equipment is medical equipment where failure of such equipment would cause serious bodily injury or death (e.g., life support, pacemakers, defibrillators, heart pumps, neurostimulators, and implantables). Such equipment includes, without limitation, all medical devices identified by the U.S. Food and Drug Administration as Class III devices and equivalent classifications outside the U.S.

TI may expressly designate certain products as completing a particular qualification (e.g., Q100, Military Grade, or Enhanced Product). Designers agree that it has the necessary expertise to select the product with the appropriate qualification designation for their applications and that proper product selection is at Designers' own risk. Designers are solely responsible for compliance with all legal and regulatory requirements in connection with such selection.

Designer will fully indemnify TI and its representatives against any damages, costs, losses, and/or liabilities arising out of Designer's non-compliance with the terms and provisions of this Notice.

单击下面可查看定价，库存，交付和生命周期等信息

[>>TI\(德州仪器\)](#)