

## CMOS BCD-to-Seven-Segment Latch/Decoder/Driver For Liquid-Crystal Displays

High-Voltage Types (20-Volt Rating)

**Features:**

- Display blanking of all illegal input combinations
- Latch storage of code
- Capability of driving two low power TTL loads, two HTL loads, or one low power Schottky load over the full rated-temperature range
- Pin-for-pin replacement for the CD4056B (with pin 7 tied to V<sub>SS</sub>)
- Direct LED driving capability

■ CD4543B is a BCD-to-seven segment latch/decoder/driver designed primarily for liquid-crystal display (LCD) applications. It is also capable of driving light emitting diode (LED), incandescent, gas-discharge, and fluorescent displays. This device is functionally similar to and serves as direct replacement for the CD4056B when pin 7 is connected to V<sub>SS</sub>. It differs from the CD4056B in that it has a display blanking capability instead of a level-shifting function and requires only one power supply. When the CD4056B is used in the level shifting mode, two power supplies are required. When the CD4543B is used for LCD applications, a square wave must be applied to the PHASE input and the backplane of the LCD device. For LED applications a logic 0 is required at the PHASE input for common-cathode devices; a logic 1 is required for common-anode devices (see truth table).

The CD4543B is supplied in 16-lead dual-in-line plastic packages (E suffix), 16-lead small-outline packages (M, M96, MT, and NSR suffixes), and 16-lead thin shrink small-outline packages (PW and PWR suffixes).

**MAXIMUM RATINGS, Absolute-Maximum Values:**

DC SUPPLY-VOLTAGE RANGE, (V <sub>DD</sub> )	
Voltages referenced to V <sub>SS</sub> Terminal)	..... -0.5V to +20V
INPUT VOLTAGE RANGE, ALL INPUTS	..... -0.5V to V <sub>DD</sub> +0.5V
DC INPUT CURRENT, ANY ONE INPUT	..... ±10mA
POWER DISSIPATION PER PACKAGE (P <sub>D</sub> ):	
For T <sub>A</sub> = -55°C to +100°C	..... 500mW
For T <sub>A</sub> = +100°C to +125°C	..... Derate Linearly at 12mW/°C to 200mW
DEVICE DISSIPATION PER OUTPUT TRANSISTOR	
FOR T <sub>A</sub> = FULL PACKAGE-TEMPERATURE RANGE (All Package Types)	..... 100mW
OPERATING-TEMPERATURE RANGE (T <sub>A</sub> )	..... -55°C to +125°C
STORAGE TEMPERATURE RANGE (T <sub>stg</sub> )	..... -65°C to +150°C
LEAD TEMPERATURE (DURING SOLDERING):	
At distance 1/16 ± 1/32 inch (1.59 ± 0.79mm) from case for 10s max	..... +265°C

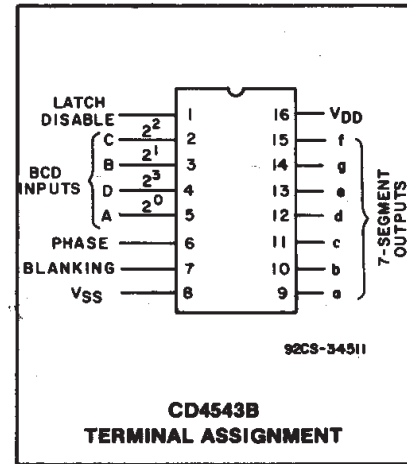

- 100% tested for quiescent current at 20 V
- Maximum input current of 1 μA at 18 V over full package-temperature range; 100 nA at 18 V and 25°C
- Noise margin (full package-temperature range) = 1 V at V<sub>DD</sub>=5 V  
2 V at V<sub>DD</sub>=10 V  
2.5 V at V<sub>DD</sub>=15 V
- 5-V, 10-V, and 15-V parametric ratings
- Meets all requirements of JEDEC Tentative Standard No. 13B, "Standard Specifications for Description of 'B' Series CMOS Devices"

**Applications:**

- Instrument display driver
- Dashboard display driver
- Computer/calculator display driver
- Timing device driver (clocks, watches, timers)

**3**  
COMMERCIAL CMOS  
HIGH VOLTAGE ICs

# CD4543B Types



Fig. 1 - BCD-to-seven-segment latch/decoder/driver CD4543B logic circuit diagram.

## RECOMMENDED OPERATING CONDITIONS at T<sub>A</sub>=25°C, Unless Otherwise Specified

For maximum reliability, nominal operating conditions should be selected so that operation is always within the following ranges:

CHARACTERISTIC	V <sub>DD</sub> (V)	LIMITS		UNITS
		MIN.	TYP.	
Supply-Voltage Range (For T <sub>A</sub> =Full Package-Temperature Range)	—	3	18	V
Latch Disable Pulse Width	5	250	125	ns
	10	100	50	
	15	80	40	
Minimum Data Setup Time	5	60	15	
	10	20	-5	
	15	10	-5	
Minimum Data Hold Time	5	25	-5	
	10	20	10	
	15	20	10	

# CD4543B Types

## STATIC ELECTRICAL CHARACTERISTICS

CHARACTERISTIC	CONDITIONS			LIMITS AT INDICATED TEMPERATURES (°C)							UNITS	
	V <sub>O</sub> (V)	V <sub>IN</sub> (V)	V <sub>DD</sub> (V)	-55	-40	+85	+125	+25				
								Min.	Typ.	Max.		
Quiescent Device Current Max.	—	0, 5	5	5	5	150	150	—	0.04	5	μA	
		0, 10	10	10	10	300	300	—	0.04	10		
		0, 15	15	20	20	600	600	—	0.04	20		
		0, 20	20	100	100	3000	3000	—	0.08	100		
Output Low (Sink) Current Min.	I <sub>OL</sub>	0.4	0, 5	5	0.64	0.61	0.42	0.36	0.51	1	—	mA
		0.5	0, 10	10	1.6	1.5	1.1	0.9	1.3	2.6	—	
		1.5	0, 15	15	4.2	4	2.8	2.4	3.4	6.8	—	
Output High (Source) Current Min.	I <sub>OH</sub>	4.6	0, 5	5	-0.46	-0.44	-0.30	-0.26	-0.37	-0.75	—	mA
		2.5	0, 5	5	-1.6	-1.5	-1.1	-0.9	-1.3	-2.6	—	
		9.5	0, 10	10	-0.98	-0.92	-0.68	-0.55	-0.8	-1.6	—	
		13.5	0, 15	15	-3.33	-3.18	-2.2	-1.9	-2.7	-5.4	—	
Output Voltage: Low-Level Max.	V <sub>OL</sub>	—	0, 5	5	0.05			—	0	0.05	V	
		—	0, 10	10	0.05			—	0	0.05		
		—	0, 15	15	0.05			—	0	0.05		
Output Voltage: High-Level Min.	V <sub>OH</sub>	—	0, 5	5	4.95			4.95	5	—	V	
		—	0, 10	10	9.95			9.95	10	—		
		—	0, 15	15	14.95			14.95	15	—		
Input Low Voltage Max.	V <sub>IL</sub>	0.5, 4.5	—	5	1.5			—	—	1.5	V	
		1, 9	—	10	3			—	—	3		
		1.5, 13.5	—	15	4			—	—	4		
Input High Voltage Min.	V <sub>IH</sub>	0.5, 4.5	—	5	3.5			3.5	—	—	V	
		1, 9	—	10	7			7	—	—		
		1.5, 13.5	—	15	11			11	—	—		
Input Current Max.	I <sub>IN</sub>	—	0, 18	18	±0.1	±0.1	±1	±1	—	±10 <sup>-5</sup>	±0.1	μA

3  
COMMERCIAL CMOS  
HIGH VOLTAGE ICs

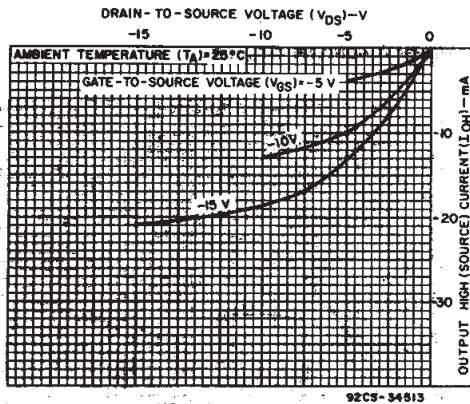

Fig. 2 - Typical output high (source) current characteristics.

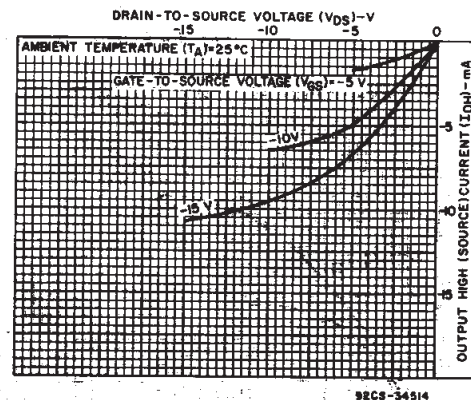

Fig. 3 - Minimum output high (source) current characteristics.

## CD4543B Types

DYNAMIC ELECTRICAL CHARACTERISTICS at  $T_A=25^\circ\text{C}$ ;  $C_L=50\text{ pF}$ , Input  $t_r, t_f=20\text{ ns}$ ,  $R_L=200\text{ k}\Omega$

CHARACTERISTIC		TEST CONDITIONS $V_{DD}$ (V)	LIMITS All Packages			UNITS
			MIN.	TYP.	MAX.	
Propagation Delay Time	$t_{PHL}$	5	—	600	1200	ns
		10	—	200	400	
		15	—	150	300	
	$t_{PLH}$	5	—	500	1000	
		10	—	200	400	
		15	—	150	300	
Transition Time	$t_{THL}$	5	—	180	360	
		10	—	90	180	
		15	—	65	130	
	$t_{TLH}$	5	—	180	360	
		10	—	90	180	
		15	—	65	130	
Latch Disable Pulse Width	$t_{WH}$	5	250	125	—	
		10	100	50	—	
		15	80	40	—	
Address Setup Time	$t_{SU}$	5	60	15	—	
		10	20	-5	—	
		15	10	-5	—	
Address Hold Time	$t_H$	5	25	-5	—	
		10	20	10	—	
		15	20	10	—	
Input Capacitance	$C_{iN}$	Any Input	—	5	7.5	pF



Fig. 4 - BCD-to-seven-segment latch/decoder/driver functional diagram.



Fig. 5 - Typical output low (sink) current characteristics.



Fig. 6 - Minimum output low (sink) current characteristics.

# CD4543B Types

## TRUTH TABLE FOR CD4543B

INPUT CODE							OUTPUT STATE							DISPLAY CHARACTER
LD	BI	Ph*	D	C	B	A	a	b	c	d	e	f	g	
X	1	0	X	X	X	X	0	0	0	0	0	0	0	0
1	0	0	0	0	0	0	1	1	1	1	1	1	0	0
1	0	0	0	0	0	1	0	1	1	0	0	0	0	0
1	0	0	0	0	1	0	1	1	0	1	1	0	1	0
1	0	0	0	0	1	1	1	1	1	1	0	0	1	0
1	0	0	0	1	0	0	0	1	1	0	0	1	1	0
1	0	0	0	1	0	1	1	0	1	1	0	1	1	0
1	0	0	0	1	1	0	1	1	1	1	1	1	1	0
1	0	0	0	1	1	1	1	1	1	0	0	0	0	0
1	0	0	1	0	0	0	1	1	1	1	1	1	1	1
1	0	0	1	0	0	1	1	1	1	0	1	1	1	1
1	0	0	1	0	1	0	0	0	0	0	0	0	0	0
1	0	0	1	0	1	1	0	0	0	0	0	0	0	0
1	0	0	1	1	0	0	0	0	0	0	0	0	0	0
1	0	0	1	1	0	1	0	0	0	0	0	0	0	0
1	0	0	1	1	1	0	0	0	0	0	0	0	0	0
1	0	0	1	1	1	1	0	0	0	0	0	0	0	0
0	0	0	X	X	X	X	**							**
†	†	1	†				Inverse of Output Combinations Above							Display as above

X=Don't care.

†=Above combinations.

\*=For liquid-crystal readouts, apply a square wave to Ph.

For common cathode LED readouts, select Ph=0.

For common anode LED readouts, select Ph=1.

\*\*=Depends upon the BCD code previously applied when LD=1.



Fig. 7 - Typical transition time as a function of load capacitance.

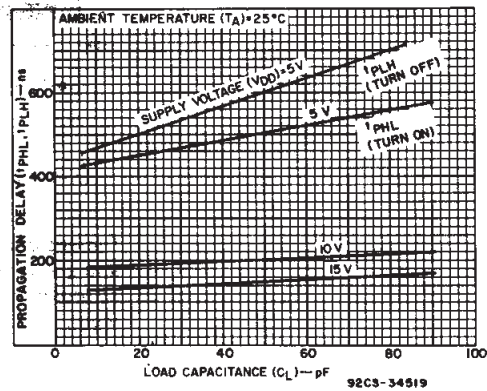

Fig. 8 - Typical propagation delay time as a function of load capacitance.

# CD4543B Types



Fig. 9 - Typical dynamic power dissipation as a function of frequency.



Fig. 10 - Quiescent device current test circuit.



Fig. 11 - Input voltage test circuit.

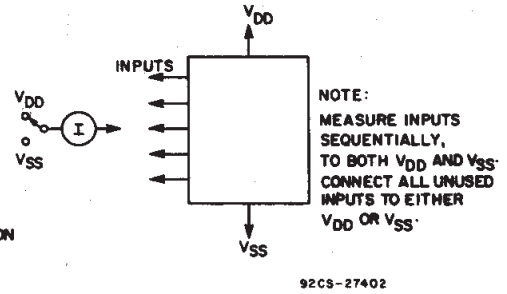
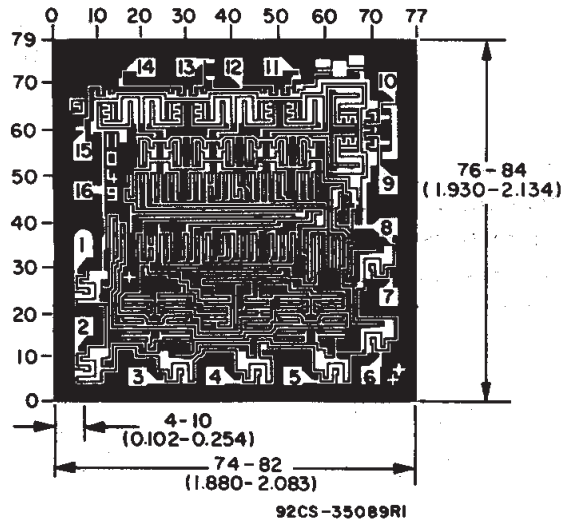

Fig. 12 - Input current test circuit.



Dimensions and pad layout for CD4543BH.

Dimensions in parentheses are in millimeters and are derived from the basic inch dimensions as indicated. Grid graduations are in mils ( $10^{-3}$  inch).

**PACKAGING INFORMATION**

Orderable Device	Status (1)	Package Type	Package Drawing	Pins	Package Qty	Eco Plan (2)	Lead finish/ Ball material (6)	MSL Peak Temp (3)	Op Temp (°C)	Device Marking (4/5)	Samples
CD4543BE	ACTIVE	PDIP	N	16	25	RoHS & Green	NIPDAU	N / A for Pkg Type	-55 to 125	CD4543BE	<a href="#">Samples</a>
CD4543BEE4	ACTIVE	PDIP	N	16	25	RoHS & Green	NIPDAU	N / A for Pkg Type	-55 to 125	CD4543BE	<a href="#">Samples</a>
CD4543BM96	ACTIVE	SOIC	D	16	2500	RoHS & Green	NIPDAU	Level-1-260C-UNLIM	-55 to 125	CD4543BM	<a href="#">Samples</a>
CD4543BNSR	ACTIVE	SO	NS	16	2000	RoHS & Green	NIPDAU	Level-1-260C-UNLIM	-55 to 125	CD4543B	<a href="#">Samples</a>
CD4543BPW	LIFEBUY	TSSOP	PW	16	90	RoHS & Green	NIPDAU	Level-1-260C-UNLIM	-55 to 125	CM543B	
CD4543BPWR	ACTIVE	TSSOP	PW	16	2000	RoHS & Green	NIPDAU	Level-1-260C-UNLIM	-55 to 125	CM543B	<a href="#">Samples</a>

(1) The marketing status values are defined as follows:

**ACTIVE:** Product device recommended for new designs.

**LIFEBUY:** TI has announced that the device will be discontinued, and a lifetime-buy period is in effect.

**NRND:** Not recommended for new designs. Device is in production to support existing customers, but TI does not recommend using this part in a new design.

**PREVIEW:** Device has been announced but is not in production. Samples may or may not be available.

**OBSOLETE:** TI has discontinued the production of the device.

(2) **RoHS:** TI defines "RoHS" to mean semiconductor products that are compliant with the current EU RoHS requirements for all 10 RoHS substances, including the requirement that RoHS substance do not exceed 0.1% by weight in homogeneous materials. Where designed to be soldered at high temperatures, "RoHS" products are suitable for use in specified lead-free processes. TI may reference these types of products as "Pb-Free".

**RoHS Exempt:** TI defines "RoHS Exempt" to mean products that contain lead but are compliant with EU RoHS pursuant to a specific EU RoHS exemption.

**Green:** TI defines "Green" to mean the content of Chlorine (Cl) and Bromine (Br) based flame retardants meet JS709B low halogen requirements of <=1000ppm threshold. Antimony trioxide based flame retardants must also meet the <=1000ppm threshold requirement.

(3) MSL, Peak Temp. - The Moisture Sensitivity Level rating according to the JEDEC industry standard classifications, and peak solder temperature.

(4) There may be additional marking, which relates to the logo, the lot trace code information, or the environmental category on the device.

(5) Multiple Device Markings will be inside parentheses. Only one Device Marking contained in parentheses and separated by a "~" will appear on a device. If a line is indented then it is a continuation of the previous line and the two combined represent the entire Device Marking for that device.

(6) Lead finish/Ball material - Orderable Devices may have multiple material finish options. Finish options are separated by a vertical ruled line. Lead finish/Ball material values may wrap to two lines if the finish value exceeds the maximum column width.

**Important Information and Disclaimer:** The information provided on this page represents TI's knowledge and belief as of the date that it is provided. TI bases its knowledge and belief on information provided by third parties, and makes no representation or warranty as to the accuracy of such information. Efforts are underway to better integrate information from third parties. TI has taken and continues to take reasonable steps to provide representative and accurate information but may not have conducted destructive testing or chemical analysis on incoming materials and chemicals. TI and TI suppliers consider certain information to be proprietary, and thus CAS numbers and other limited information may not be available for release.

In no event shall TI's liability arising out of such information exceed the total purchase price of the TI part(s) at issue in this document sold by TI to Customer on an annual basis.



**TAPE AND REEL INFORMATION**

**QUADRANT ASSIGNMENTS FOR PIN 1 ORIENTATION IN TAPE**

\*All dimensions are nominal

Device	Package Type	Package Drawing	Pins	SPQ	Reel Diameter (mm)	Reel Width W1 (mm)	A0 (mm)	B0 (mm)	K0 (mm)	P1 (mm)	W (mm)	Pin1 Quadrant
CD4543BM96	SOIC	D	16	2500	330.0	16.4	6.5	10.3	2.1	8.0	16.0	Q1
CD4543BNSR	SO	NS	16	2000	330.0	16.4	8.2	10.5	2.5	12.0	16.0	Q1
CD4543BPWR	TSSOP	PW	16	2000	330.0	12.4	6.9	5.6	1.6	8.0	12.0	Q1

**TAPE AND REEL BOX DIMENSIONS**

\*All dimensions are nominal

Device	Package Type	Package Drawing	Pins	SPQ	Length (mm)	Width (mm)	Height (mm)
CD4543BM96	SOIC	D	16	2500	340.5	336.1	32.0
CD4543BNSR	SO	NS	16	2000	356.0	356.0	35.0
CD4543BPWR	TSSOP	PW	16	2000	356.0	356.0	35.0

**TUBE**

\*All dimensions are nominal

Device	Package Name	Package Type	Pins	SPQ	L (mm)	W (mm)	T (μm)	B (mm)
CD4543BE	N	PDIP	16	25	506	13.97	11230	4.32
CD4543BE	N	PDIP	16	25	506	13.97	11230	4.32
CD4543BEE4	N	PDIP	16	25	506	13.97	11230	4.32
CD4543BEE4	N	PDIP	16	25	506	13.97	11230	4.32
CD4543BPW	PW	TSSOP	16	90	530	10.2	3600	3.5



# PACKAGE OUTLINE

## NS0016A

### SOP - 2.00 mm max height

SOP



4220735/A 12/2021

#### NOTES:

1. All linear dimensions are in millimeters. Dimensions in parenthesis are for reference only. Dimensioning and tolerancing per ASME Y14.5M.
2. This drawing is subject to change without notice.
3. This dimension does not include mold flash, protrusions, or gate burrs. Mold flash, protrusions, or gate burrs shall not exceed 0.15 mm, per side.
4. This dimension does not include interlead flash. Interlead flash shall not exceed 0.25 mm, per side.

# EXAMPLE BOARD LAYOUT

NS0016A

SOP - 2.00 mm max height

SOP



SOLDER MASK DETAILS

4220735/A 12/2021

NOTES: (continued)

5. Publication IPC-7351 may have alternate designs.

6. Solder mask tolerances between and around signal pads can vary based on board fabrication site.

# EXAMPLE STENCIL DESIGN

NS0016A

SOP - 2.00 mm max height

SOP



SOLDER PASTE EXAMPLE  
BASED ON 0.125 mm THICK STENCIL  
SCALE:7X

4220735/A 12/2021

NOTES: (continued)



7. Laser cutting apertures with trapezoidal walls and rounded corners may offer better paste release. IPC-7525 may have alternate design recommendations.
8. Board assembly site may have different recommendations for stencil design.

D (R-PDSO-G16)

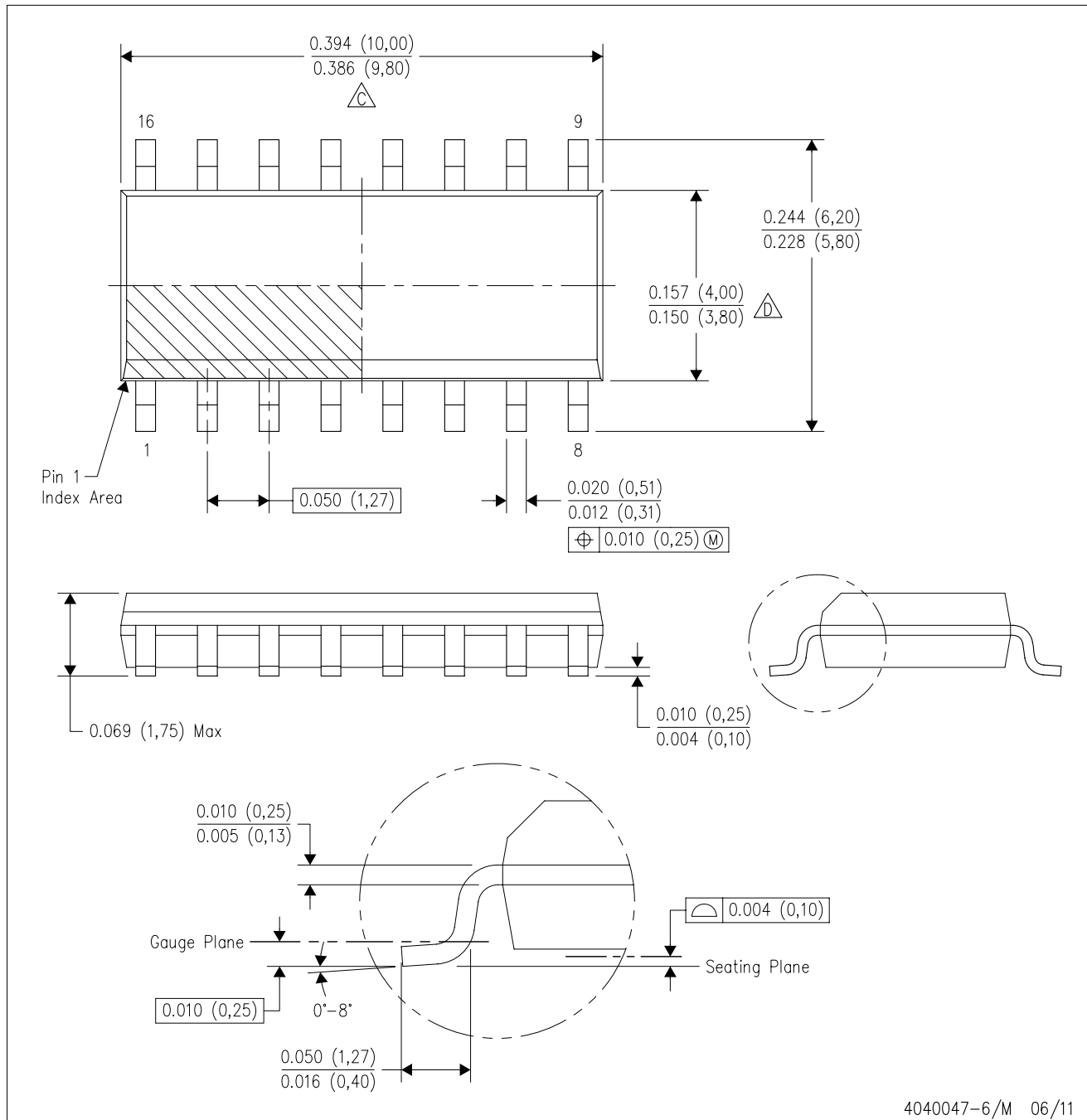
PLASTIC SMALL OUTLINE



4040047-6/M 06/11

- NOTES:
- A. All linear dimensions are in inches (millimeters).
  - B. This drawing is subject to change without notice.
  -  Body length does not include mold flash, protrusions, or gate burrs. Mold flash, protrusions, or gate burrs shall not exceed 0.006 (0,15) each side.
  -  Body width does not include interlead flash. Interlead flash shall not exceed 0.017 (0,43) each side.
  - E. Reference JEDEC MS-012 variation AC.



4220204/A 02/2017

NOTES:

1. All linear dimensions are in millimeters. Any dimensions in parenthesis are for reference only. Dimensioning and tolerancing per ASME Y14.5M.
2. This drawing is subject to change without notice.
3. This dimension does not include mold flash, protrusions, or gate burrs. Mold flash, protrusions, or gate burrs shall not exceed 0.15 mm per side.
4. This dimension does not include interlead flash. Interlead flash shall not exceed 0.25 mm per side.
5. Reference JEDEC registration MO-153.



# EXAMPLE BOARD LAYOUT

PW0016A

TSSOP - 1.2 mm max height

SMALL OUTLINE PACKAGE



LAND PATTERN EXAMPLE  
EXPOSED METAL SHOWN  
SCALE: 10X



4220204/A 02/2017

NOTES: (continued)

- 6. Publication IPC-7351 may have alternate designs.
- 7. Solder mask tolerances between and around signal pads can vary based on board fabrication site.

# EXAMPLE STENCIL DESIGN

PW0016A

TSSOP - 1.2 mm max height

SMALL OUTLINE PACKAGE

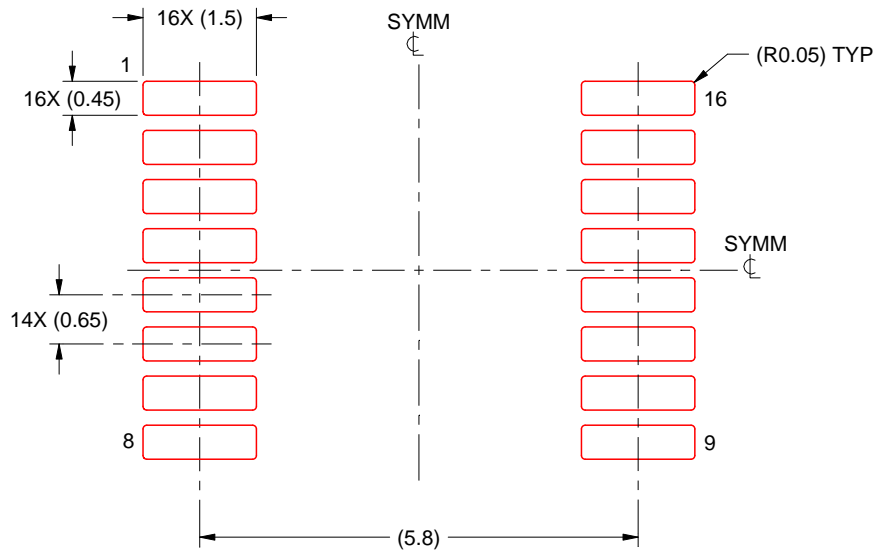

SOLDER PASTE EXAMPLE  
BASED ON 0.125 mm THICK STENCIL  
SCALE: 10X

4220204/A 02/2017

NOTES: (continued)

8. Laser cutting apertures with trapezoidal walls and rounded corners may offer better paste release. IPC-7525 may have alternate design recommendations.
9. Board assembly site may have different recommendations for stencil design.

# MECHANICAL DATA

NS (R-PDSO-G\*\*)

PLASTIC SMALL-OUTLINE PACKAGE

14-PINS SHOWN



- NOTES:
- A. All linear dimensions are in millimeters.
  - B. This drawing is subject to change without notice.
  - C. Body dimensions do not include mold flash or protrusion, not to exceed 0,15.

N (R-PDIP-T\*\*)

PLASTIC DUAL-IN-LINE PACKAGE

16 PINS SHOWN



- NOTES:
- A. All linear dimensions are in inches (millimeters).
  - B. This drawing is subject to change without notice.
  - Falls within JEDEC MS-001, except 18 and 20 pin minimum body length (Dim A).
  - The 20 pin end lead shoulder width is a vendor option, either half or full width.

## IMPORTANT NOTICE AND DISCLAIMER

TI PROVIDES TECHNICAL AND RELIABILITY DATA (INCLUDING DATA SHEETS), DESIGN RESOURCES (INCLUDING REFERENCE DESIGNS), APPLICATION OR OTHER DESIGN ADVICE, WEB TOOLS, SAFETY INFORMATION, AND OTHER RESOURCES "AS IS" AND WITH ALL FAULTS, AND DISCLAIMS ALL WARRANTIES, EXPRESS AND IMPLIED, INCLUDING WITHOUT LIMITATION ANY IMPLIED WARRANTIES OF MERCHANTABILITY, FITNESS FOR A PARTICULAR PURPOSE OR NON-INFRINGEMENT OF THIRD PARTY INTELLECTUAL PROPERTY RIGHTS.

These resources are intended for skilled developers designing with TI products. You are solely responsible for (1) selecting the appropriate TI products for your application, (2) designing, validating and testing your application, and (3) ensuring your application meets applicable standards, and any other safety, security, regulatory or other requirements.

These resources are subject to change without notice. TI grants you permission to use these resources only for development of an application that uses the TI products described in the resource. Other reproduction and display of these resources is prohibited. No license is granted to any other TI intellectual property right or to any third party intellectual property right. TI disclaims responsibility for, and you will fully indemnify TI and its representatives against, any claims, damages, costs, losses, and liabilities arising out of your use of these resources.

TI's products are provided subject to [TI's Terms of Sale](#) or other applicable terms available either on [ti.com](https://www.ti.com) or provided in conjunction with such TI products. TI's provision of these resources does not expand or otherwise alter TI's applicable warranties or warranty disclaimers for TI products.

TI objects to and rejects any additional or different terms you may have proposed.

Mailing Address: Texas Instruments, Post Office Box 655303, Dallas, Texas 75265  
Copyright © 2023, Texas Instruments Incorporated

单击下面可查看定价，库存，交付和生命周期等信息

[>>TI\(德州仪器\)](#)