

SNx4LVC08A Quadruple 2-Input Positive-AND Gates

1 Features

- Latch-Up Performance Exceeds 250 mA Per JESD 17
- ESD Protection Exceeds JESD 22
 - 2000-V Human-Body Model (A114-A)
 - 200-V Machine Model (A115-A)
 - 1000-V Charged-Device Model (C101)
 - On Products Compliant to MIL-PRF-38535, All Parameters Are Tested Unless Otherwise Noted. On All Other Products, Production Processing Does Not Necessarily Include Testing of All Parameters.
- SN74LVC04A Operates From 1.65 V to 3.6 V
- SN54LVC04A Operates From 2.0 V to 3.6 V
- SNx4LVC08A Specified From -40°C to $+85^{\circ}\text{C}$ and -40°C to $+125^{\circ}\text{C}$
- SN54LVC08A Specified From -55°C to $+125^{\circ}\text{C}$
- Inputs Accept Voltages to 5.5 V
- Max t_{pd} of 4.1 ns at 3.3 V
- Typical V_{OLP} (Output Ground Bounce) <0.8 V at $V_{CC} = 3.3$ V, $T_A = 25^{\circ}\text{C}$
- Typical V_{OHV} (Output V_{OH} Undershoot) >2 V at $V_{CC} = 3.3$ V, $T_A = 25^{\circ}\text{C}$

2 Applications

- Servers
- LED Displays
- Network Switches
- I/O Expanders
- Base Station Processor Board

3 Description

The SN54LVC08A quadruple 2-input positive-AND gate is designed for 2.7-V to 3.6-V V_{CC} operation, and the SN74LVC08A quadruple 2-input positive-AND gate is designed for 1.65-V to 3.6-V V_{CC} operation.

The SNx4LVC08A devices perform the Boolean function $Y = A \bullet B$ or $Y = \overline{A} + \overline{B}$ in positive logic.

Inputs can be driven from either 3.3-V or 5-V devices. This feature allows the use of these devices as translators in a mixed 3.3-V/5-V system environment.

Device Information⁽¹⁾

PART NUMBER	PACKAGE	BODY SIZE (NOM)
SNJ54LVC08AW	CFP (14)	9.21 mm × 5.97 mm
SNJ54LVC08AJ	CDIP (14)	19.56 mm × 6.92 mm
SNJ54LVC08AFK	LCCC (20)	8.89 mm × 8.89 mm
SN74LVC08ARGY	VQFN (14)	3.50 mm × 3.50 mm
SN74LVC08APW	TSSOP (14)	5.00 mm × 4.40 mm
SN74LVC08ANS	SO (14)	10.30 mm × 5.30 mm
SN74LVC08AD	SOIC (14)	8.65 mm × 3.91 mm
SN74LVC08ADB	SSOP (14)	6.20 mm × 5.30 mm

(1) For all available packages, see the orderable addendum at the end of the data sheet.

Logic Diagram, Each Gate (Positive Logic)



Table of Contents

1 Features	1	8.1 Overview	10
2 Applications	1	8.2 Functional Block Diagram	10
3 Description	1	8.3 Feature Description	10
4 Revision History	2	8.4 Device Functional Modes	11
5 Pin Configuration and Functions	4	9 Application and Implementation	12
6 Specifications	5	9.1 Application Information	12
6.1 Absolute Maximum Ratings	5	9.2 Typical Application	12
6.2 ESD Ratings	5	10 Power Supply Recommendations	13
6.3 Recommended Operating Conditions for SN54LVC08A	5	11 Layout	14
6.4 Recommended Operating Conditions for SN74LVC08A	6	11.1 Layout Guidelines	14
6.5 Thermal Information	6	11.2 Layout Examples	14
6.6 Electrical Characteristics for SN54LVC08A	7	12 Device and Documentation Support	15
6.7 Electrical Characteristics for SN74LVC08A	7	12.1 Related Documentation	15
6.8 Switching Characteristics for SN54LVC08A	7	12.2 Related Links	15
6.9 Switching Characteristics for SN74LVC08A	8	12.3 Receiving Notification of Documentation Updates	15
6.10 Operating Characteristics	8	12.4 Community Resources	15
6.11 Typical Characteristics	8	12.5 Trademarks	15
7 Parameter Measurement Information	9	12.6 Electrostatic Discharge Caution	15
8 Detailed Description	10	12.7 Glossary	15
		13 Mechanical, Packaging, and Orderable Information	15

4 Revision History

NOTE: Page numbers for previous revisions may differ from page numbers in the current version.

Changes from Revision S (August 2015) to Revision T	Page
• Changed the order and content of the Features list	1
• Deleted I_{off} throughout data sheet	1
• Deleted <i>Device Options</i> table, see <i>Mechanical, Packaging, and Orderable Information</i> at the end of the data sheet	1
• Added $V_O > V_{CC}$ to Output clamp current	5
• Changed MAX value for Output clamp current, I_{OK} and Continuous output current, I_O from: -50 to ± 50	5
• Changed values in the Thermal Information table to align with JEDEC standards.	6
• Added <i>Balanced High-Drive CMOS Push-Pull Outputs, Standard CMOS Inputs, Clamp Diodes, and Over-voltage Tolerant Inputs</i>	10
• Deleted sentence referencing " I_{off} support....." in the Feature Description section.	10
• Changed Inputs and Output in <i>Truth Table</i>	11
• Added figure: <i>Trace Example</i> in <i>Layout Examples</i>	14
• Added <i>Related Documentation</i> and <i>Receiving Notification of Documentation Updates</i>	15

Changes from Revision R (June 2015) to Revision S	Page
• Added T_J junction temperature spec to Abs Max Ratings	5

Changes from Revision Q (November 2010) to Revision R	Page
• Updated document to new TI data sheet format - no specification changes.	1
• Added <i>Applications</i> , <i>Device Information</i> table, <i>Pin Configuration and Functions</i> section, <i>ESD Ratings</i> table, <i>Feature Description</i> section, <i>Device Functional Modes</i> , <i>Application and Implementation</i> section, <i>Power Supply Recommendations</i> section, <i>Layout</i> section, <i>Device and Documentation Support</i> section, and <i>Mechanical, Packaging, and Orderable Information</i> section	1

- Added Military Disclaimer to *Features*..... 1
- Added *Thermal Information* table 6

5 Pin Configuration and Functions

D, DB, NS, J, W, or PW Package
14-Pin SOIC, SSOP, SOP, CDIP, or TSSOP
Top View

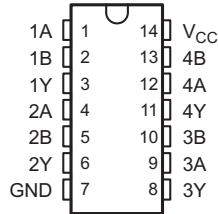

RGY Package
14-Pin VQFN
Top View

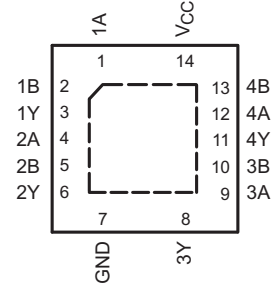

FK Package
20-Pin LCCC
Top View

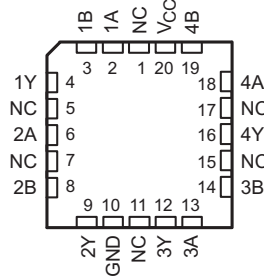

Pin Functions

NAME	PIN		TYPE	DESCRIPTION
	SOIC, SSOP, SOP, CDIP, TSSOP	LCCC		
1A	1	2	I	Channel 1 input A
1B	2	3	I	Channel 1 input B
1Y	3	4	O	Channel 1 output
2A	4	6	I	Channel 2 input A
2B	5	8	I	Channel 2 input B
2Y	6	9	O	Channel 2 output
3Y	8	12	O	Channel 3 output
3A	9	13	I	Channel 3 input A
3B	10	14	I	Channel 3 input B
4Y	11	16	O	Channel 4 output
4A	12	18	I	Channel 4 input A
4B	13	19	I	Channel 4 input B
GND	7	10	Ground	Ground
NC ⁽¹⁾	—	1	—	No connect
		5		
		7		
		11		
		15		
V _{CC}	14	20	Power	Positive supply

(1) NC – No internal connection

6 Specifications

6.1 Absolute Maximum Ratings

over operating free-air temperature range (unless otherwise noted)⁽¹⁾

		MIN	MAX	UNIT	
V _{CC}	Supply voltage	-0.5	6.5	V	
V _I	Input voltage ⁽²⁾	-0.5	6.5	V	
V _O	Output voltage ⁽²⁾⁽³⁾	-0.5	V _{CC} + 0.5	V	
I _{IK}	Input clamp current	V _I < 0		-50	mA
I _{OK}	Output clamp current	V _O < 0 or V _O > V _{CC}		±50	mA
I _O	Continuous output current			±50	mA
Continuous current through V _{CC} or GND				±100	mA
P _{tot}	Power dissipation ⁽⁴⁾⁽⁵⁾	T _A = -40°C to +125°C		500	mW
T _J	Junction temperature	-65	150	°C	
T _{stg}	Storage temperature	-65	150	°C	

- (1) Stresses beyond those listed under *Absolute Maximum Ratings* may cause permanent damage to the device. These are stress ratings only, and functional operation of the device at these or any other conditions beyond those indicated under *Recommended Operating Conditions* is not implied. Exposure to absolute-maximum-rated conditions for extended periods may affect device reliability.
- (2) The input and output negative-voltage ratings may be exceeded if the input and output current ratings are observed.
- (3) The value of V_{CC} is provided in the *Recommended Operating Conditions* table.
- (4) For the D package: above 70°C, the value of P_{tot} derates linearly with 8 mW/K.
- (5) For the DB, NS, and PW packages: above 60°C, the value of P_{tot} derates linearly with 5.5 mW/K.

6.2 ESD Ratings

		VALUE	UNIT
V _(ESD)	Electrostatic discharge	Human body model (HBM), per ANSI/ESDA/JEDEC JS-001 ⁽¹⁾	±2000
		Charged-device model (CDM), per JEDEC specification JESD22-C101 ⁽²⁾	±1000
		Machine Model (MM) A115-A	200

- (1) JEDEC document JEP155 states that 500-V HBM allows safe manufacturing with a standard ESD control process.
- (2) JEDEC document JEP157 states that 250-V CDM allows safe manufacturing with a standard ESD control process.

6.3 Recommended Operating Conditions for SN54LVC08A

See⁽¹⁾

		SN54LVC08A		UNIT	
		-55°C to +125°C			
		MIN	MAX		
V _{CC}	Supply voltage	Operating	2	3.6	V
		Data retention only	1.5		
V _{IH}	High-level input voltage	V _{CC} = 2.7 V to 3.6 V		2	V
V _{IL}	Low-level input voltage	V _{CC} = 2.7 V to 3.6 V		0.8	V
V _I	Input voltage	0	5.5		V
V _O	Output voltage	0	V _{CC}		V
I _{OH}	High-level output current	V _{CC} = 2.7 V	-12		mA
		V _{CC} = 3 V	-24		
I _{OL}	Low-level output current	V _{CC} = 2.7 V	12		mA
		V _{CC} = 3 V	24		
Δt/Δv	Input transition rise or fall rate			8	ns/V

- (1) All unused inputs of the device must be held at V_{CC} or GND to ensure proper device operation. See *Implications of Slow or Floating CMOS Inputs*, SCBA004.

6.4 Recommended Operating Conditions for SN74LVC08A

 See⁽¹⁾

		SN74LVC08A						UNIT		
		T _A = 25°C		–40°C to +85°C		–40°C to +125°C				
		MIN	MAX	MIN	MAX	MIN	MAX			
V _{CC}	Supply voltage	Operating		1.65	3.6	1.65	3.6	1.65	3.6	V
	Data retention only		1.5		1.5		1.5			
V _{IH}	High-level input voltage	V _{CC} = 1.65 V to 1.95 V	0.65 × V _{CC}		0.65 × V _{CC}		0.65 × V _{CC}		V	
		V _{CC} = 2.3 V to 2.7 V	1.7		1.7		1.7			
		V _{CC} = 2.7 V to 3.6 V	2		2		2			
V _{IL}	Low-level input voltage	V _{CC} = 1.65 V to 1.95 V	0.35 × V _{CC}		0.35 × V _{CC}		0.35 × V _{CC}		V	
		V _{CC} = 2.3 V to 2.7 V	0.7		0.7		0.7			
		V _{CC} = 2.7 V to 3.6 V	0.8		0.8		0.8			
V _I	Input voltage	0	5.5	0	5.5	0	5.5	0	5.5	V
V _O	Output voltage	0	V _{CC}	0	V _{CC}	0	V _{CC}	0	V _{CC}	V
I _{OH}	High-level output current	V _{CC} = 1.65 V	–4		–4		–4		mA	
		V _{CC} = 2.3 V	–8		–8		–8			
		V _{CC} = 2.7 V	–12		–12		–12			
		V _{CC} = 3 V	–24		–24		–24			
I _{OL}	Low-level output current	V _{CC} = 1.65 V	4		4		4		mA	
		V _{CC} = 2.3 V	8		8		8			
		V _{CC} = 2.7 V	12		12		12			
		V _{CC} = 3 V	24		24		24			
Δt/ΔV	Input transition rise or fall rate	8		8		8		ns/V		

(1) All unused inputs of the device must be held at V_{CC} or GND to ensure proper device operation. See [Implications of Slow or Floating CMOS Inputs](#), SCBA004.

6.5 Thermal Information

THERMAL METRIC ⁽¹⁾		SN74LVC08A					UNIT
		D (SOIC)	DB (SSOP)	NS (SO)	PW (TSSOP)	RGY (LCCC)	
		14 PINS	14 PINS	14 PINS	14 PINS	14 PINS	
R _{θJA}	Junction-to-ambient thermal resistance	98.6	112.8	95.1	127.7	51.1	°C/W
R _{θJC(top)}	Junction-to-case (top) thermal resistance	56.0	65.3	52.7	56.0	56.6	°C/W
R _{θJB}	Junction-to-board thermal resistance	53.3	60.2	53.9	69.5	27.5	°C/W
ψ _{JT}	Junction-to-top characterization parameter	16.4	25.3	17.9	8.9	4.5	°C/W
ψ _{JB}	Junction-to-board characterization parameter	53.0	59.6	53.6	68.9	27.7	°C/W
R _{θJC(bot)}	Junction-to-case (bottom) thermal resistance	—	—	—	—	19.1	°C/W

(1) For more information about traditional and new thermal metrics, see the [Semiconductor and IC Package Thermal Metrics](#) application report.

6.6 Electrical Characteristics for SN54LVC08A

over recommended operating free-air temperature range (unless otherwise noted)

PARAMETER	TEST CONDITIONS	V _{CC}	SN54LVC08A			UNIT
			–55°C to +125°C			
			MIN	TYP ⁽¹⁾	MAX	
V _{OH}	I _{OH} = –100 μA	2.7 V to 3.6 V	V _{CC} – 0.2			V
	I _{OH} = –12 mA	2.7 V	2.2			
		3 V	2.4			
	I _{OH} = –24 mA	3 V	2.2			
V _{OL}	I _{OL} = 100 μA	2.7 V to 3.6 V	0.2			V
	I _{OL} = 12 mA	2.7 V	0.4			
		3 V	0.55			
	I _{OL} = 24 mA	3 V	0.55			
I _I	V _I = 5.5 V or GND	3.6 V	±5			μA
I _{CC}	V _I = V _{CC} or GND, I _O = 0	3.6 V	10			μA
ΔI _{CC}	One input at V _{CC} – 0.6 V, Other inputs at V _{CC} or GND	2.7 V to 3.6 V	500			μA
C _i	V _I = V _{CC} or GND	3.3 V	5			pF

 (1) T_A = 25°C

6.7 Electrical Characteristics for SN74LVC08A

over recommended operating free-air temperature range (unless otherwise noted)

PARAMETER	TEST CONDITIONS	V _{CC}	SN74LVC08A						UNIT	
			T _A = 25°C			–40°C to +85°C		–40°C to +125°C		
			MIN	TYP	MAX	MIN	MAX	MIN		MAX
V _{OH}	I _{OH} = –100 μA	1.65 V to 3.6 V	V _{CC} – 0.2			V _{CC} – 0.2		V _{CC} – 0.3		V
	I _{OH} = –4 mA	1.65 V	1.29			1.2		1.05		
		2.3 V	1.9			1.7		1.55		
	I _{OH} = –12 mA	2.7 V	2.2			2.2		2.05		
		3 V	2.4			2.4		2.25		
	I _{OH} = –24 mA	3 V	2.3			2.2		2		
V _{OL}	I _{OL} = 100 μA	1.65 V to 3.6 V	0.1			0.2		0.3		V
	I _{OL} = 4 mA	1.65 V	0.24			0.45		0.6		
		2.3 V	0.3			0.7		0.75		
	I _{OL} = 12 mA	2.7 V	0.4			0.4		0.6		
		3 V	0.55			0.55		0.8		
	I _{OL} = 24 mA	3 V	0.55			0.55		0.8		
I _I	V _I = 5.5 V or GND	3.6 V	±1			±5		±20		μA
I _{CC}	V _I = V _{CC} or GND, I _O = 0	3.6 V	1			10		40		μA
ΔI _{CC}	One input at V _{CC} – 0.6 V, Other inputs at V _{CC} or GND	2.7 V to 3.6 V	500			500		5000		μA
C _i	V _I = V _{CC} or GND	3.3 V	5							pF

6.8 Switching Characteristics for SN54LVC08A

 over recommended operating free-air temperature range (unless otherwise noted) (see [Figure 3](#))

PARAMETER	FROM (INPUT)	TO (OUTPUT)	V _{CC}	SN54LVC08A		UNIT
				–55°C to +125°C		
				MIN	MAX	
t _{pd}	A or B	Y	2.7 V	4.8		ns
			3.3 V ± 0.3 V	1	4.1	

6.9 Switching Characteristics for SN74LVC08A

over recommended operating free-air temperature range (unless otherwise noted) (see Figure 3)

PARAMETER	FROM (INPUT)	TO (OUTPUT)	V _{CC}	SN74LVC08A						UNIT	
				T _A = 25°C			–40°C to +85°C		–40°C to +125°C		
				MIN	TYP	MAX	MIN	MAX	MIN		MAX
t _{pd}	A or B	Y	1.8 V ± 0.15 V	1	5	9.3	1	9.8	1	11.3	ns
			2.5 V ± 0.2 V	1	2.9	6.4	1	6.9	1	9	
			2.7 V	1	3	4.6	1	4.8	1	6	
			3.3 V ± 0.3 V	1	2.6	3.9	1	4.1	1	5.5	
t _{sk(o)}			3.3 V ± 0.3 V					1		1.5	ns

6.10 Operating Characteristics

T_A = 25°C

PARAMETER		TEST CONDITIONS	V _{CC}	TYP	UNIT
C _{pd}	Power dissipation capacitance per gate	f = 10 MHz	1.8 V	7	pF
			2.5 V	9.8	
			3.3 V	10	

6.11 Typical Characteristics

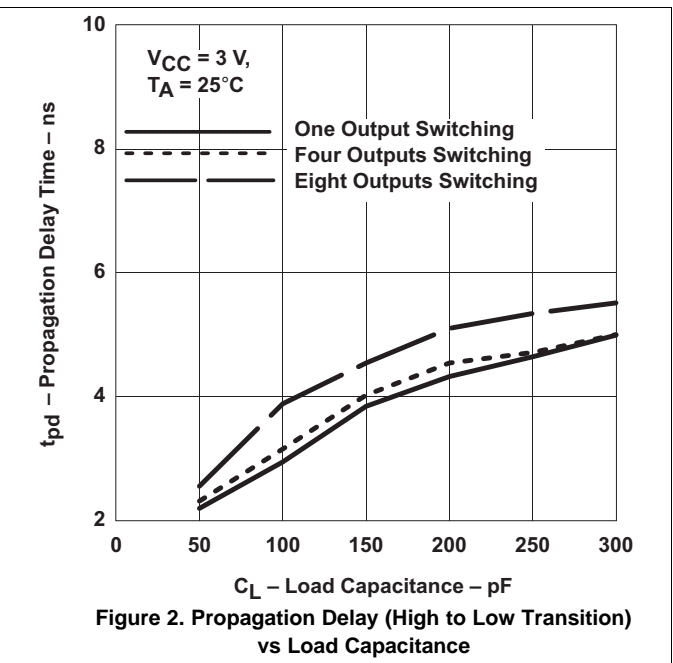
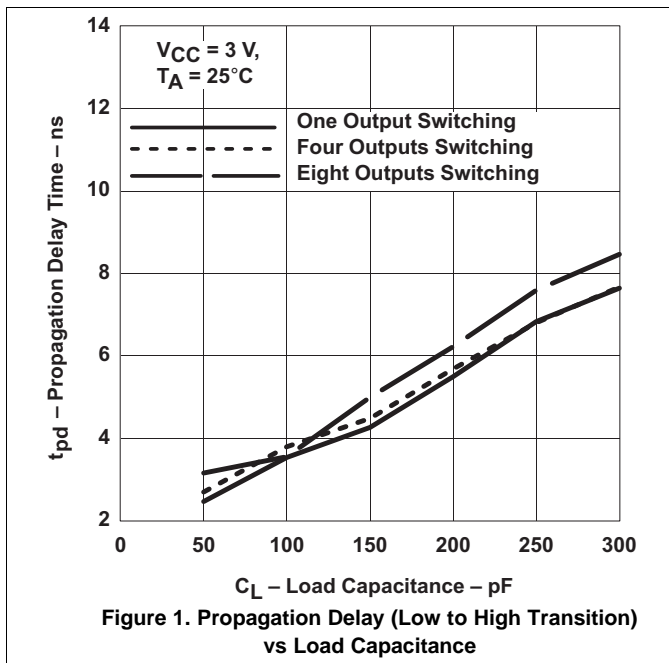

7 Parameter Measurement Information

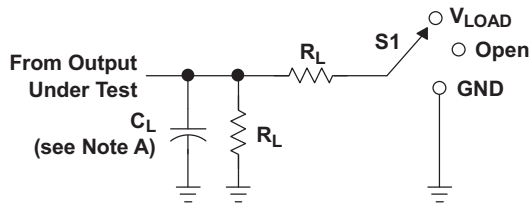

LOAD CIRCUIT

TEST	S1
t_{PLH}/t_{PHL}	Open
t_{PLZ}/t_{PZL}	V_{LOAD}
t_{PHZ}/t_{PZH}	GND

V_{CC}	INPUTS		V_M	V_{LOAD}	C_L	R_L	V_D
	V_I	t_r/t_f					
$1.8\text{ V} \pm 0.15\text{ V}$	V_{CC}	$\leq 2\text{ ns}$	$V_{CC}/2$	$2 \times V_{CC}$	30 pF	1 k Ω	0.15 V
$2.5\text{ V} \pm 0.2\text{ V}$	V_{CC}	$\leq 2\text{ ns}$	$V_{CC}/2$	$2 \times V_{CC}$	30 pF	500 Ω	0.15 V
2.7 V	2.7 V	$\leq 2.5\text{ ns}$	1.5 V	6 V	50 pF	500 Ω	0.3 V
$3.3\text{ V} \pm 0.3\text{ V}$	2.7 V	$\leq 2.5\text{ ns}$	1.5 V	6 V	50 pF	500 Ω	0.3 V

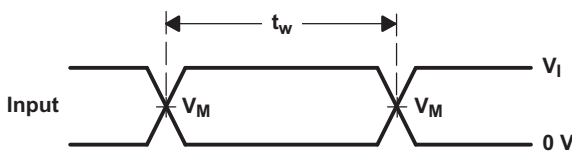

VOLTAGE WAVEFORMS PULSE DURATION

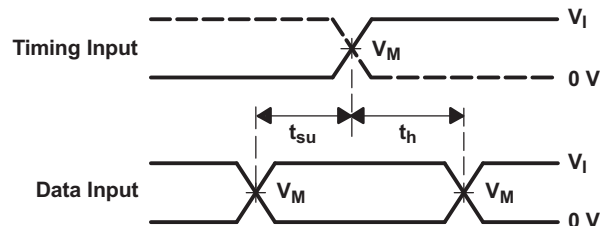

VOLTAGE WAVEFORMS SETUP AND HOLD TIMES

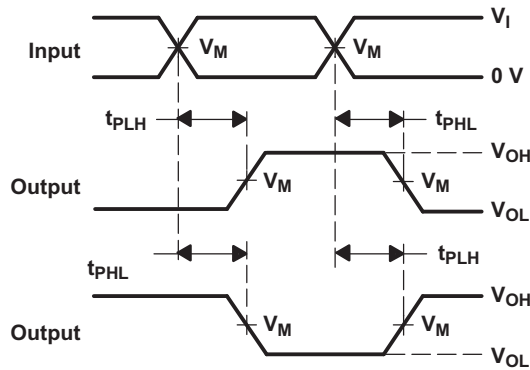

VOLTAGE WAVEFORMS PROPAGATION DELAY TIMES INVERTING AND NONINVERTING OUTPUTS

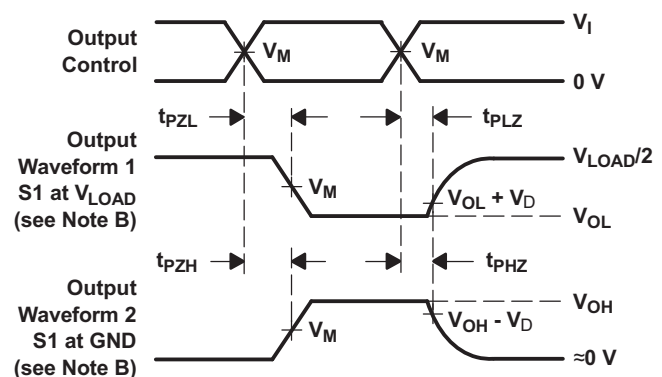

VOLTAGE WAVEFORMS ENABLE AND DISABLE TIMES LOW- AND HIGH-LEVEL ENABLING

- NOTES:
- A. C_L includes probe and jig capacitance.
 - B. Waveform 1 is for an output with internal conditions such that the output is low except when disabled by the output control. Waveform 2 is for an output with internal conditions such that the output is high, except when disabled by the output control.
 - C. All input pulses are supplied by generators having the following characteristics: $PRR \leq 10\text{ MHz}$, $Z_O = 50\text{ W}$.
 - D. The outputs are measured one at a time, with one transition per measurement.
 - E. t_{PLZ} and t_{PHZ} are the same as t_{dis} .
 - F. t_{PZL} and t_{PZH} are the same as t_{en} .
 - G. t_{PLH} and t_{PHL} are the same as t_{pd} .
 - H. All parameters and waveforms are not applicable to all devices.

Figure 3. Load Circuit and Voltage Waveforms

8 Detailed Description

8.1 Overview

The SN74LVC08 device contains four 2-input positive AND gate device and performs the Boolean function $Y = A \times B$. This device is useful when multiple AND function is used in the system.

8.2 Functional Block Diagram

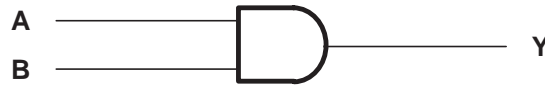

Figure 4. Logic Diagram, Each Gate (Positive Logic)

8.3 Feature Description

8.3.1 Balanced High-Drive CMOS Push-Pull Outputs

A balanced output allows the device to sink and source similar currents. The high drive capability of this device creates fast edges into light loads so routing and load conditions should be considered to prevent ringing. Additionally, the outputs of this device are capable of driving larger currents than the device can sustain without being damaged. It is important for the power output of the device to be limited to avoid thermal runaway and damage due to over-current. The electrical and thermal limits defined in the [Absolute Maximum Ratings](#) must be followed at all times.

8.3.2 Standard CMOS Inputs

Standard CMOS inputs are high impedance and are typically modelled as a resistor in parallel with the input capacitance given in the [Electrical Characteristics for SN54LVC08A](#) and [Electrical Characteristics for SN74LVC08A](#). The worst case resistance is calculated with the maximum input voltage, given in the [Absolute Maximum Ratings](#), and the maximum input leakage current, given in the [Electrical Characteristics for SN54LVC08A](#) and [Electrical Characteristics for SN74LVC08A](#), using ohm's law ($R = V \div I$).

Signals applied to the inputs need to have fast edge rates, as defined by $\Delta t/\Delta v$ in [Recommended Operating Conditions for SN54LVC08A](#) and [Recommended Operating Conditions for SN74LVC08A](#) to avoid excessive currents and oscillations. If a slow or noisy input signal is required, a device with a Schmitt-trigger input should be utilized to condition the input signal prior to the standard CMOS input.

8.3.3 Clamp Diodes

The inputs to this device have negative clamping diodes. The outputs to this device have both positive and negative clamping diodes as shown in [Figure 5](#).

CAUTION

Voltages beyond the values specified in the [Absolute Maximum Ratings](#) table can cause damage to the device. The input negative-voltage and output voltage ratings may be exceeded if the input and output clamp-current ratings are observed.

Feature Description (continued)

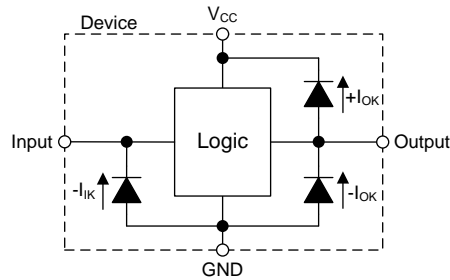

Figure 5. Electrical Placement of Clamping Diodes for Each Input and Output

8.3.4 Over-voltage Tolerant Inputs

Input signals to this device can be driven above the supply voltage so long as they remain below the maximum input voltage value specified in the *Absolute Maximum Ratings*.

8.4 Device Functional Modes

Table 1 lists the functional modes for the SN54LVC08A and SN74LVC08A devices.

Table 1. Truth Table

INPUTS		OUTPUT
A	B	Y
L	L	L
L	H	L
H	L	L
H	H	H

9 Application and Implementation

NOTE

Information in the following applications sections is not part of the TI component specification, and TI does not warrant its accuracy or completeness. TI's customers are responsible for determining suitability of components for their purposes. Customers should validate and test their design implementation to confirm system functionality.

9.1 Application Information

The SN74LVC08A is used to drive CMOS device and used for implementing AND logic. The LVC family can support current drive of about 24 mA at 3-V V_{CC} . The inputs for SN74LVC08A are 5.5-V tolerant allowing it to translate down to V_{CC} .

9.2 Typical Application

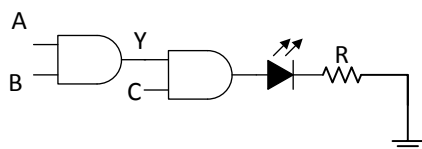

Figure 6. Three Input AND Gate Implementation and Driving LED

9.2.1 Design Requirements

This device uses CMOS technology and has balanced output drive. Take care to avoid bus contention because it can drive currents that would exceed maximum limits. The high drive will also create fast edges into light loads so routing and load conditions should be considered to prevent ringing.

9.2.2 Detailed Design Procedure

SN74LVC08A contains four AND gates in one package which can be used for individual AND function or to implement complex Boolean logic. [Figure 6](#) shows an example of implementing 3input AND function. AB are inputs for AND gate which are connected to another AND gate. $Z = A \times B \times C$. SN74LVC08A support high drive current of 24 mA which can be used to drive LEDs of even Drive low current signal FETs, an example is shown in [Figure 6](#) TI recommends to use a series resistance to limit the current. If V_{CC} is 3 V, and LED current should be 10 mA, and the forward-voltage of LED is 2.5 V, then R as shown in [Figure 6](#) is calculated using [Equation 1](#):

$$R = (V_{CC} - V_{LED}) / I \quad (1)$$

$$R = (3 - 2.5) / 0.01 = 50 \Omega$$

Typical Application (continued)

9.2.3 Application Curves

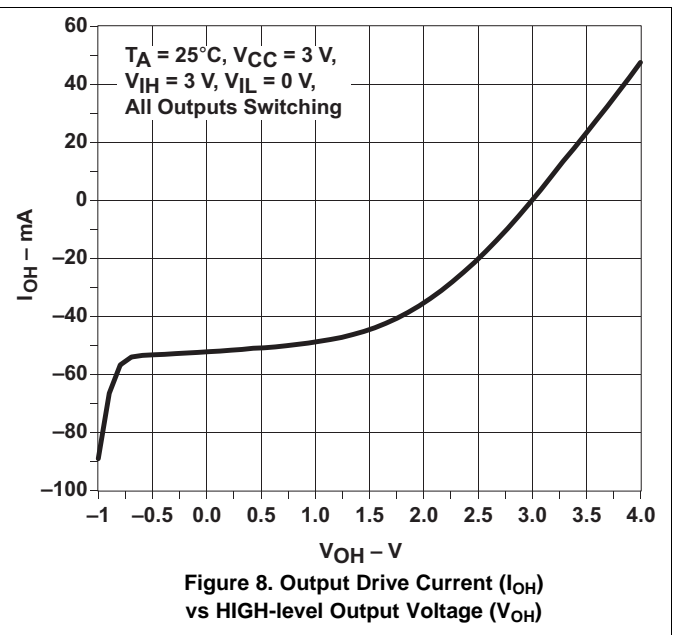
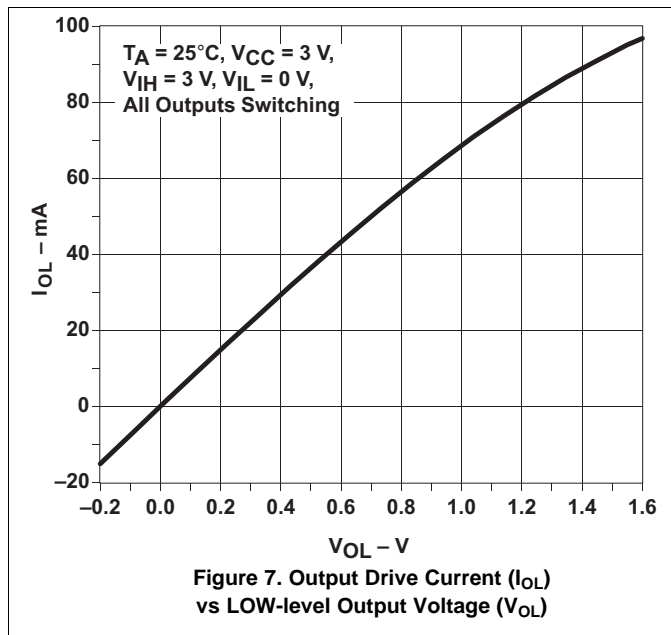

10 Power Supply Recommendations

The power supply can be any voltage between the minimum and maximum supply voltage rating located in the [Recommended Operating Conditions](#) table.

The V_{CC} pin must have a good bypass capacitor to prevent power disturbance. TI recommends to use a 0.1- μF capacitor. It is ok to parallel multiple bypass capacitors to reject different frequencies of noise. 0.1- μF and 1- μF capacitors are commonly used in parallel. The bypass capacitor should be installed as close to the power pin as possible for best results.

11 Layout

11.1 Layout Guidelines

When using multiple bit logic devices, inputs should not float. In many cases, functions or parts of functions of digital logic devices are unused. Some examples are when only two inputs of a triple-input AND gate are used, or when only 3 of the 4-buffer gates are used. Such input pins should not be left unconnected because the undefined voltages at the outside connections result in undefined operational states.

Specified in [Figure 9](#) are rules that must be observed under all circumstances. All unused inputs of digital logic devices must be connected to a high or low bias to prevent them from floating. The logic level that should be applied to any particular unused input depends on the function of the device. Generally they will be tied to GND or VCC, whichever makes more sense or is more convenient.

Even low data rate digital signals can have high frequency signal components due to fast edge rates. When a PCB trace turns a corner at a 90° angle, a reflection can occur. A reflection occurs primarily because of the change of width of the trace. At the apex of the turn, the trace width increases to 1.414 times the width. This increase upsets the transmission-line characteristics, especially the distributed capacitance and self-inductance of the trace which results in the reflection. Not all PCB traces can be straight and therefore some traces must turn corners. [Figure 10](#) shows progressively better techniques of rounding corners. Only the last example (BEST) maintains constant trace width and minimizes reflections.

11.2 Layout Examples

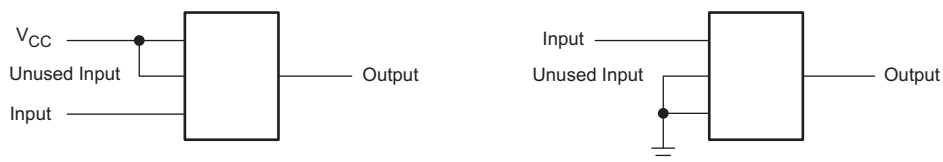

Figure 9. Proper Multi-Gate Input Termination Diagram

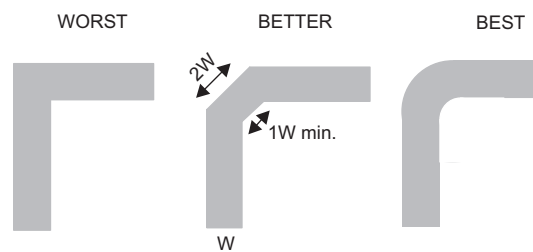

Figure 10. Trace Example

12 Device and Documentation Support

12.1 Related Documentation

For related documentation see the following:

[Implications of Slow or Floating CMOS Inputs](#), SCBA004

12.2 Related Links

The table below lists quick access links. Categories include technical documents, support and community resources, tools and software, and quick access to order now.

Table 2. Related Links

PARTS	PRODUCT FOLDER	ORDER NOW	TECHNICAL DOCUMENTS	TOOLS & SOFTWARE	SUPPORT & COMMUNITY
SN54LVC08A	Click here	Click here	Click here	Click here	Click here
SN74LVC08A	Click here	Click here	Click here	Click here	Click here

12.3 Receiving Notification of Documentation Updates

To receive notification of documentation updates, navigate to the device product folder on ti.com. In the upper right corner, click on *Alert me* to register and receive a weekly digest of any product information that has changed. For change details, review the revision history included in any revised document.

12.4 Community Resources

The following links connect to TI community resources. Linked contents are provided "AS IS" by the respective contributors. They do not constitute TI specifications and do not necessarily reflect TI's views; see TI's [Terms of Use](#).

TI E2E™ Online Community *TI's Engineer-to-Engineer (E2E) Community*. Created to foster collaboration among engineers. At e2e.ti.com, you can ask questions, share knowledge, explore ideas and help solve problems with fellow engineers.

Design Support *TI's Design Support* Quickly find helpful E2E forums along with design support tools and contact information for technical support.

12.5 Trademarks

E2E is a trademark of Texas Instruments.
All other trademarks are the property of their respective owners.

12.6 Electrostatic Discharge Caution



These devices have limited built-in ESD protection. The leads should be shorted together or the device placed in conductive foam during storage or handling to prevent electrostatic damage to the MOS gates.

12.7 Glossary

[SLYZ022](#) — *TI Glossary*.

This glossary lists and explains terms, acronyms, and definitions.

13 Mechanical, Packaging, and Orderable Information

The following pages include mechanical packaging and orderable information. This information is the most current data available for the designated devices. This data is subject to change without notice and revision of this document. For browser based versions of this data sheet, refer to the left hand navigation.

PACKAGING INFORMATION

Orderable Device	Status (1)	Package Type	Package Drawing	Pins	Package Qty	Eco Plan (2)	Lead finish/ Ball material (6)	MSL Peak Temp (3)	Op Temp (°C)	Device Marking (4/5)	Samples
5962-9753401Q2A	ACTIVE	LCCC	FK	20	55	Non-RoHS & Green	SNPB	N / A for Pkg Type	-55 to 125	5962-9753401Q2A SNJ54LVC08AFK	Samples
5962-9753401QCA	ACTIVE	CDIP	J	14	25	Non-RoHS & Green	SNPB	N / A for Pkg Type	-55 to 125	5962-9753401QC A SNJ54LVC08AJ	Samples
5962-9753401QDA	ACTIVE	CFP	W	14	25	Non-RoHS & Green	SNPB	N / A for Pkg Type	-55 to 125	5962-9753401QD A SNJ54LVC08AW	Samples
SN74LVC08AD	ACTIVE	SOIC	D	14	50	RoHS & Green	NIPDAU	Level-1-260C-UNLIM	-40 to 125	LVC08A	Samples
SN74LVC08ADBR	ACTIVE	SSOP	DB	14	2000	RoHS & Green	NIPDAU	Level-1-260C-UNLIM	-40 to 125	LC08A	Samples
SN74LVC08ADBRE4	ACTIVE	SSOP	DB	14	2000	RoHS & Green	NIPDAU	Level-1-260C-UNLIM	-40 to 125	LC08A	Samples
SN74LVC08ADE4	ACTIVE	SOIC	D	14	50	RoHS & Green	NIPDAU	Level-1-260C-UNLIM	-40 to 125	LVC08A	Samples
SN74LVC08ADG4	ACTIVE	SOIC	D	14	50	RoHS & Green	NIPDAU	Level-1-260C-UNLIM	-40 to 125	LVC08A	Samples
SN74LVC08ADR	ACTIVE	SOIC	D	14	2500	RoHS & Green	NIPDAU SN	Level-1-260C-UNLIM	-40 to 125	LVC08A	Samples
SN74LVC08ADRE4	ACTIVE	SOIC	D	14	2500	RoHS & Green	NIPDAU	Level-1-260C-UNLIM	-40 to 125	LVC08A	Samples
SN74LVC08ADRG3	ACTIVE	SOIC	D	14	2500	RoHS & Green	SN	Level-1-260C-UNLIM	-40 to 125	LVC08A	Samples
SN74LVC08ADRG4	ACTIVE	SOIC	D	14	2500	RoHS & Green	NIPDAU	Level-1-260C-UNLIM	-40 to 125	LVC08A	Samples
SN74LVC08ADT	ACTIVE	SOIC	D	14	250	RoHS & Green	NIPDAU	Level-1-260C-UNLIM	-40 to 125	LVC08A	Samples
SN74LVC08ANSR	ACTIVE	SO	NS	14	2000	RoHS & Green	NIPDAU	Level-1-260C-UNLIM	-40 to 125	LVC08A	Samples
SN74LVC08ANSRE4	ACTIVE	SO	NS	14	2000	RoHS & Green	NIPDAU	Level-1-260C-UNLIM	-40 to 125	LVC08A	Samples
SN74LVC08APW	ACTIVE	TSSOP	PW	14	90	RoHS & Green	NIPDAU	Level-1-260C-UNLIM	-40 to 125	LC08A	Samples
SN74LVC08APWG4	ACTIVE	TSSOP	PW	14	90	RoHS & Green	NIPDAU	Level-1-260C-UNLIM	-40 to 125	LC08A	Samples

Orderable Device	Status (1)	Package Type	Package Drawing	Pins	Package Qty	Eco Plan (2)	Lead finish/ Ball material (6)	MSL Peak Temp (3)	Op Temp (°C)	Device Marking (4/5)	Samples
SN74LVC08APWR	ACTIVE	TSSOP	PW	14	2000	RoHS & Green	NIPDAU SN	Level-1-260C-UNLIM	-40 to 125	LC08A	Samples
SN74LVC08APWRE4	ACTIVE	TSSOP	PW	14	2000	RoHS & Green	NIPDAU	Level-1-260C-UNLIM	-40 to 125	LC08A	Samples
SN74LVC08APWRG3	ACTIVE	TSSOP	PW	14	2000	RoHS & Green	SN	Level-1-260C-UNLIM	-40 to 125	LC08A	Samples
SN74LVC08APWRG4	ACTIVE	TSSOP	PW	14	2000	RoHS & Green	NIPDAU	Level-1-260C-UNLIM	-40 to 125	LC08A	Samples
SN74LVC08APWT	ACTIVE	TSSOP	PW	14	250	RoHS & Green	NIPDAU	Level-1-260C-UNLIM	-40 to 125	LC08A	Samples
SN74LVC08APWTG4	ACTIVE	TSSOP	PW	14	250	RoHS & Green	NIPDAU	Level-1-260C-UNLIM	-40 to 125	LC08A	Samples
SN74LVC08ARGYR	ACTIVE	VQFN	RGY	14	3000	RoHS & Green	NIPDAU	Level-2-260C-1 YEAR	-40 to 125	LC08A	Samples
SN74LVC08ARGYRG4	ACTIVE	VQFN	RGY	14	3000	RoHS & Green	NIPDAU	Level-2-260C-1 YEAR	-40 to 125	LC08A	Samples
SNJ54LVC08AFK	ACTIVE	LCCC	FK	20	55	Non-RoHS & Green	SNPB	N / A for Pkg Type	-55 to 125	5962-9753401Q2A SNJ54LVC08AFK	Samples
SNJ54LVC08AJ	ACTIVE	CDIP	J	14	25	Non-RoHS & Green	SNPB	N / A for Pkg Type	-55 to 125	5962-9753401QC A SNJ54LVC08AJ	Samples
SNJ54LVC08AW	ACTIVE	CFP	W	14	25	Non-RoHS & Green	SNPB	N / A for Pkg Type	-55 to 125	5962-9753401QD A SNJ54LVC08AW	Samples

(1) The marketing status values are defined as follows:

ACTIVE: Product device recommended for new designs.

LIFEBUY: TI has announced that the device will be discontinued, and a lifetime-buy period is in effect.

NRND: Not recommended for new designs. Device is in production to support existing customers, but TI does not recommend using this part in a new design.

PREVIEW: Device has been announced but is not in production. Samples may or may not be available.

OBSOLETE: TI has discontinued the production of the device.

(2) **RoHS:** TI defines "RoHS" to mean semiconductor products that are compliant with the current EU RoHS requirements for all 10 RoHS substances, including the requirement that RoHS substance do not exceed 0.1% by weight in homogeneous materials. Where designed to be soldered at high temperatures, "RoHS" products are suitable for use in specified lead-free processes. TI may reference these types of products as "Pb-Free".

RoHS Exempt: TI defines "RoHS Exempt" to mean products that contain lead but are compliant with EU RoHS pursuant to a specific EU RoHS exemption.

Green: TI defines "Green" to mean the content of Chlorine (Cl) and Bromine (Br) based flame retardants meet JS709B low halogen requirements of <=1000ppm threshold. Antimony trioxide based flame retardants must also meet the <=1000ppm threshold requirement.

(3) MSL, Peak Temp. - The Moisture Sensitivity Level rating according to the JEDEC industry standard classifications, and peak solder temperature.

(4) There may be additional marking, which relates to the logo, the lot trace code information, or the environmental category on the device.

(5) Multiple Device Markings will be inside parentheses. Only one Device Marking contained in parentheses and separated by a "~" will appear on a device. If a line is indented then it is a continuation of the previous line and the two combined represent the entire Device Marking for that device.

(6) Lead finish/Ball material - Orderable Devices may have multiple material finish options. Finish options are separated by a vertical ruled line. Lead finish/Ball material values may wrap to two lines if the finish value exceeds the maximum column width.

Important Information and Disclaimer:The information provided on this page represents TI's knowledge and belief as of the date that it is provided. TI bases its knowledge and belief on information provided by third parties, and makes no representation or warranty as to the accuracy of such information. Efforts are underway to better integrate information from third parties. TI has taken and continues to take reasonable steps to provide representative and accurate information but may not have conducted destructive testing or chemical analysis on incoming materials and chemicals. TI and TI suppliers consider certain information to be proprietary, and thus CAS numbers and other limited information may not be available for release.

In no event shall TI's liability arising out of such information exceed the total purchase price of the TI part(s) at issue in this document sold by TI to Customer on an annual basis.

OTHER QUALIFIED VERSIONS OF SN54LVC08A, SN74LVC08A :

- Catalog : [SN74LVC08A](#)

- Automotive : [SN74LVC08A-Q1](#), [SN74LVC08A-Q1](#)

- Enhanced Product : [SN74LVC08A-EP](#), [SN74LVC08A-EP](#)

- Military : [SN54LVC08A](#)

NOTE: Qualified Version Definitions:

- Catalog - TI's standard catalog product

- Automotive - Q100 devices qualified for high-reliability automotive applications targeting zero defects

- Enhanced Product - Supports Defense, Aerospace and Medical Applications

- Military - QML certified for Military and Defense Applications

TAPE AND REEL INFORMATION

QUADRANT ASSIGNMENTS FOR PIN 1 ORIENTATION IN TAPE

*All dimensions are nominal

Device	Package Type	Package Drawing	Pins	SPQ	Reel Diameter (mm)	Reel Width W1 (mm)	A0 (mm)	B0 (mm)	K0 (mm)	P1 (mm)	W (mm)	Pin1 Quadrant
SN74LVC08ADBR	SSOP	DB	14	2000	330.0	16.4	8.35	6.6	2.4	12.0	16.0	Q1
SN74LVC08ADR	SOIC	D	14	2500	330.0	16.4	6.5	9.0	2.1	8.0	16.0	Q1
SN74LVC08ADRG3	SOIC	D	14	2500	330.0	16.8	6.5	9.5	2.1	8.0	16.0	Q1
SN74LVC08ADRG4	SOIC	D	14	2500	330.0	16.4	6.5	9.0	2.1	8.0	16.0	Q1
SN74LVC08ADRG4	SOIC	D	14	2500	330.0	16.4	6.5	9.0	2.1	8.0	16.0	Q1
SN74LVC08ADT	SOIC	D	14	250	330.0	16.4	6.5	9.0	2.1	8.0	16.0	Q1
SN74LVC08ANSR	SO	NS	14	2000	330.0	16.4	8.2	10.5	2.5	12.0	16.0	Q1
SN74LVC08APWR	TSSOP	PW	14	2000	330.0	12.4	6.9	5.6	1.6	8.0	12.0	Q1
SN74LVC08APWRG3	TSSOP	PW	14	2000	330.0	12.4	6.9	5.6	1.6	8.0	12.0	Q1
SN74LVC08APWRG4	TSSOP	PW	14	2000	330.0	12.4	6.9	5.6	1.6	8.0	12.0	Q1
SN74LVC08APWT	TSSOP	PW	14	250	330.0	12.4	6.9	5.6	1.6	8.0	12.0	Q1
SN74LVC08ARGYR	VQFN	RGY	14	3000	330.0	12.4	3.75	3.75	1.15	8.0	12.0	Q1

TAPE AND REEL BOX DIMENSIONS

*All dimensions are nominal

Device	Package Type	Package Drawing	Pins	SPQ	Length (mm)	Width (mm)	Height (mm)
SN74LVC08ADBR	SSOP	DB	14	2000	356.0	356.0	35.0
SN74LVC08ADR	SOIC	D	14	2500	340.5	336.1	32.0
SN74LVC08ADRG3	SOIC	D	14	2500	364.0	364.0	27.0
SN74LVC08ADRG4	SOIC	D	14	2500	356.0	356.0	35.0
SN74LVC08ADRG4	SOIC	D	14	2500	340.5	336.1	32.0
SN74LVC08ADT	SOIC	D	14	250	210.0	185.0	35.0
SN74LVC08ANSR	SO	NS	14	2000	356.0	356.0	35.0
SN74LVC08APWR	TSSOP	PW	14	2000	356.0	356.0	35.0
SN74LVC08APWRG3	TSSOP	PW	14	2000	364.0	364.0	27.0
SN74LVC08APWRG4	TSSOP	PW	14	2000	356.0	356.0	35.0
SN74LVC08APWT	TSSOP	PW	14	250	356.0	356.0	35.0
SN74LVC08ARGYR	VQFN	RGY	14	3000	356.0	356.0	35.0

TUBE

*All dimensions are nominal

Device	Package Name	Package Type	Pins	SPQ	L (mm)	W (mm)	T (μm)	B (mm)
5962-9753401Q2A	FK	LCCC	20	55	506.98	12.06	2030	NA
5962-9753401QDA	W	CFP	14	25	506.98	26.16	6220	NA
SN74LVC08AD	D	SOIC	14	50	506.6	8	3940	4.32
SN74LVC08ADE4	D	SOIC	14	50	506.6	8	3940	4.32
SN74LVC08ADG4	D	SOIC	14	50	506.6	8	3940	4.32
SN74LVC08APW	PW	TSSOP	14	90	530	10.2	3600	3.5
SN74LVC08APWG4	PW	TSSOP	14	90	530	10.2	3600	3.5
SNJ54LVC08AFK	FK	LCCC	20	55	506.98	12.06	2030	NA
SNJ54LVC08AW	W	CFP	14	25	506.98	26.16	6220	NA

RGY (S-PVQFN-N14)

PLASTIC QUAD FLATPACK NO-LEAD



- NOTES:
- A. All linear dimensions are in millimeters. Dimensioning and tolerancing per ASME Y14.5M-1994.
 - B. This drawing is subject to change without notice.
 - C. QFN (Quad Flatpack No-Lead) package configuration.
 - D. The package thermal pad must be soldered to the board for thermal and mechanical performance.
 - E. See the additional figure in the Product Data Sheet for details regarding the exposed thermal pad features and dimensions.
 - F. Pin 1 identifiers are located on both top and bottom of the package and within the zone indicated. The Pin 1 identifiers are either a molded, marked, or metal feature.
 - G. Package complies to JEDEC MO-241 variation BA.

RGY (S-PVQFN-N14)

PLASTIC QUAD FLATPACK NO-LEAD

THERMAL INFORMATION

This package incorporates an exposed thermal pad that is designed to be attached directly to an external heatsink. The thermal pad must be soldered directly to the printed circuit board (PCB). After soldering, the PCB can be used as a heatsink. In addition, through the use of thermal vias, the thermal pad can be attached directly to the appropriate copper plane shown in the electrical schematic for the device, or alternatively, can be attached to a special heatsink structure designed into the PCB. This design optimizes the heat transfer from the integrated circuit (IC).

For information on the Quad Flatpack No-Lead (QFN) package and its advantages, refer to Application Report, QFN/SON PCB Attachment, Texas Instruments Literature No. SLUA271. This document is available at www.ti.com.

The exposed thermal pad dimensions for this package are shown in the following illustration.

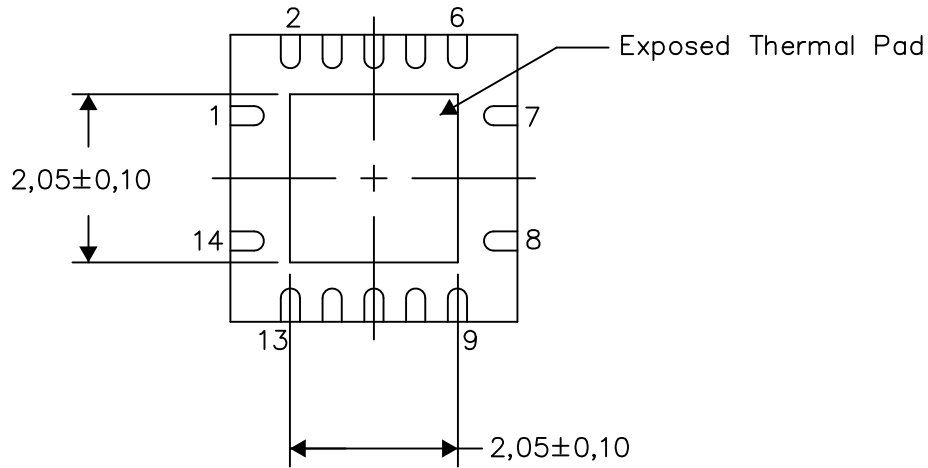

Bottom View

Exposed Thermal Pad Dimensions

4206353-2/P 03/14

NOTE: All linear dimensions are in millimeters

RGY (S-PVQFN-N14)

PLASTIC QUAD FLATPACK NO-LEAD

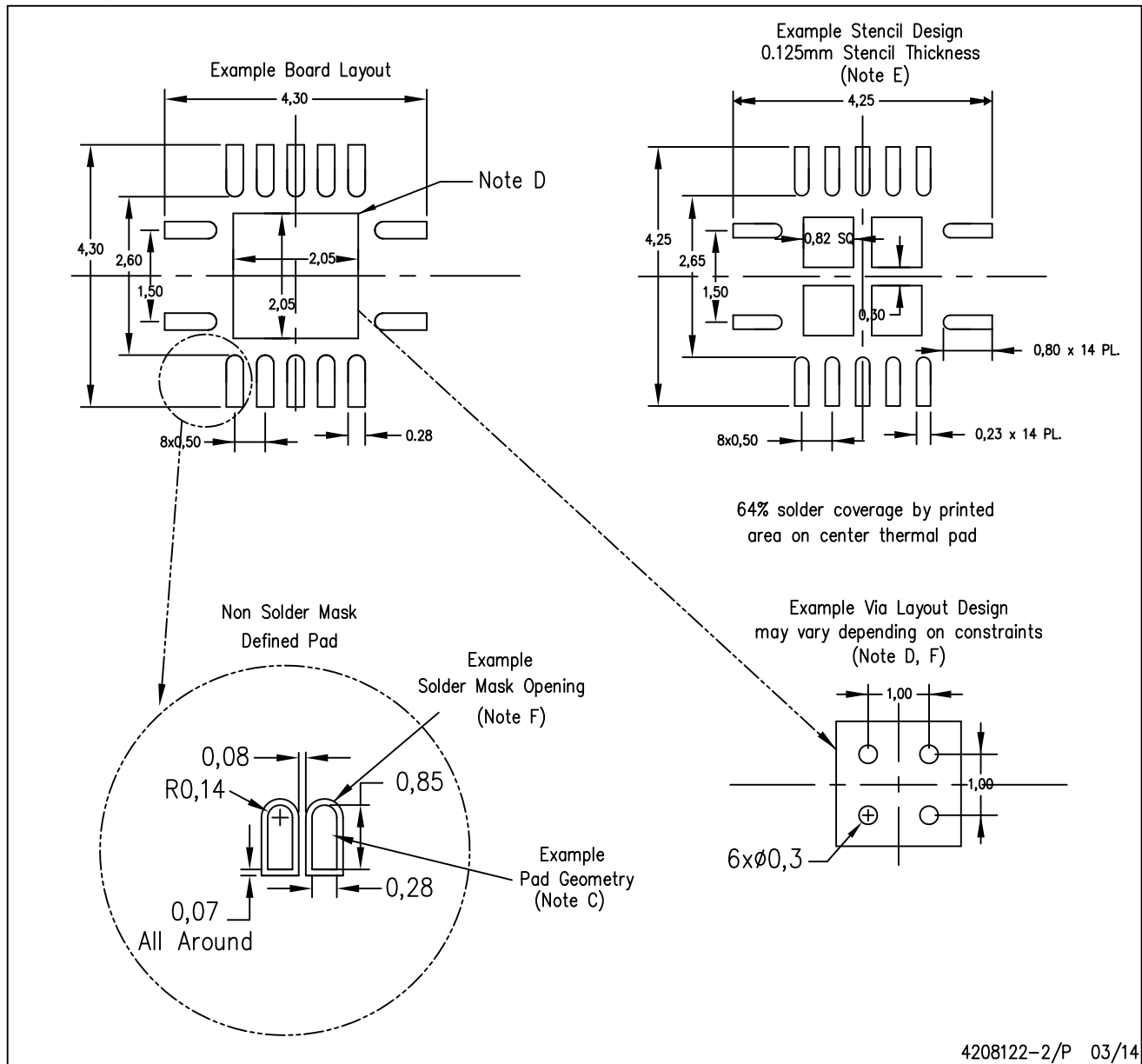

4208122-2/P 03/14

- NOTES:
- All linear dimensions are in millimeters.
 - This drawing is subject to change without notice.
 - Publication IPC-7351 is recommended for alternate designs.
 - This package is designed to be soldered to a thermal pad on the board. Refer to Application Note, Quad Flat-Pack QFN/SON PCB Attachment, Texas Instruments Literature No. SLUA271, and also the Product Data Sheets for specific thermal information, via requirements, and recommended board layout. These documents are available at www.ti.com <<http://www.ti.com>>.
 - Laser cutting apertures with trapezoidal walls and also rounding corners will offer better paste release. Customers should contact their board assembly site for stencil design recommendations. Refer to IPC 7525 for stencil design considerations.
 - Customers should contact their board fabrication site for minimum solder mask web tolerances between signal pads.

MECHANICAL DATA

NS (R-PDSO-G**)

PLASTIC SMALL-OUTLINE PACKAGE

14-PINS SHOWN



- NOTES:
- A. All linear dimensions are in millimeters.
 - B. This drawing is subject to change without notice.
 - C. Body dimensions do not include mold flash or protrusion, not to exceed 0,15.

W (R-GDFP-F14)

CERAMIC DUAL FLATPACK



- NOTES:
- A. All linear dimensions are in inches (millimeters).
 - B. This drawing is subject to change without notice.
 - C. This package can be hermetically sealed with a ceramic lid using glass frit.
 - D. Index point is provided on cap for terminal identification only.
 - E. Falls within MIL STD 1835 GDFP1-F14

GENERIC PACKAGE VIEW

FK 20

LCCC - 2.03 mm max height

8.89 x 8.89, 1.27 mm pitch

LEADLESS CERAMIC CHIP CARRIER

This image is a representation of the package family, actual package may vary.
Refer to the product data sheet for package details.



4229370VA\

J 14

GENERIC PACKAGE VIEW
CDIP - 5.08 mm max height
CERAMIC DUAL IN LINE PACKAGE



Images above are just a representation of the package family, actual package may vary.
Refer to the product data sheet for package details.

4040083-5/G

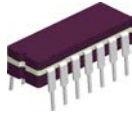

J0014A

PACKAGE OUTLINE

CDIP - 5.08 mm max height

CERAMIC DUAL IN LINE PACKAGE



4214771/A 05/2017

NOTES:

1. All controlling linear dimensions are in inches. Dimensions in brackets are in millimeters. Any dimension in brackets or parenthesis are for reference only. Dimensioning and tolerancing per ASME Y14.5M.
2. This drawing is subject to change without notice.
3. This package is hermetically sealed with a ceramic lid using glass frit.
4. Index point is provided on cap for terminal identification only and on press ceramic glass frit seal only.
5. Falls within MIL-STD-1835 and GDIP1-T14.

EXAMPLE BOARD LAYOUT

J0014A

CDIP - 5.08 mm max height

CERAMIC DUAL IN LINE PACKAGE



LAND PATTERN EXAMPLE
NON-SOLDER MASK DEFINED
SCALE: 5X





4214771/A 05/2017

D (R-PDSO-G14)

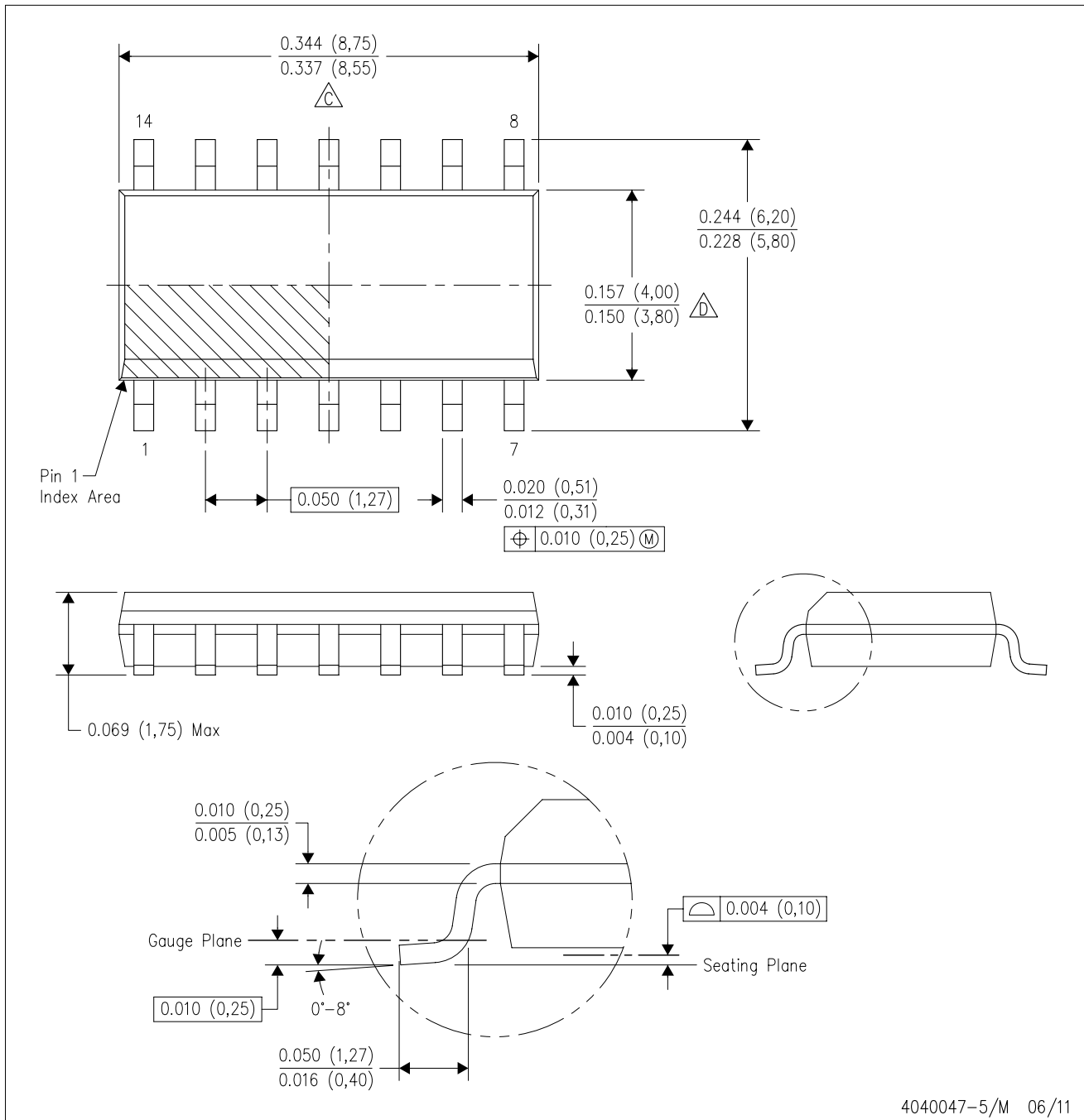
PLASTIC SMALL OUTLINE



4040047-5/M 06/11

- NOTES:
- A. All linear dimensions are in inches (millimeters).
 - B. This drawing is subject to change without notice.
 -  Body length does not include mold flash, protrusions, or gate burrs. Mold flash, protrusions, or gate burrs shall not exceed 0.006 (0,15) each side.
 -  Body width does not include interlead flash. Interlead flash shall not exceed 0.017 (0,43) each side.
 - E. Reference JEDEC MS-012 variation AB.

D (R-PDSO-G14)

PLASTIC SMALL OUTLINE



- NOTES:
- A. All linear dimensions are in millimeters.
 - B. This drawing is subject to change without notice.
 - C. Publication IPC-7351 is recommended for alternate designs.
 - D. Laser cutting apertures with trapezoidal walls and also rounding corners will offer better paste release. Customers should contact their board assembly site for stencil design recommendations. Refer to IPC-7525 for other stencil recommendations.
 - E. Customers should contact their board fabrication site for solder mask tolerances between and around signal pads.

PW (R-PDSO-G14)

PLASTIC SMALL OUTLINE



4040064-3/G 02/11

- NOTES:
- A. All linear dimensions are in millimeters. Dimensioning and tolerancing per ASME Y14.5M-1994.
 - B. This drawing is subject to change without notice.
 - C. Body length does not include mold flash, protrusions, or gate burrs. Mold flash, protrusions, or gate burrs shall not exceed 0,15 each side.
 - D. Body width does not include interlead flash. Interlead flash shall not exceed 0,25 each side.
 - E. Falls within JEDEC MO-153

PW (R-PDSO-G14)

PLASTIC SMALL OUTLINE

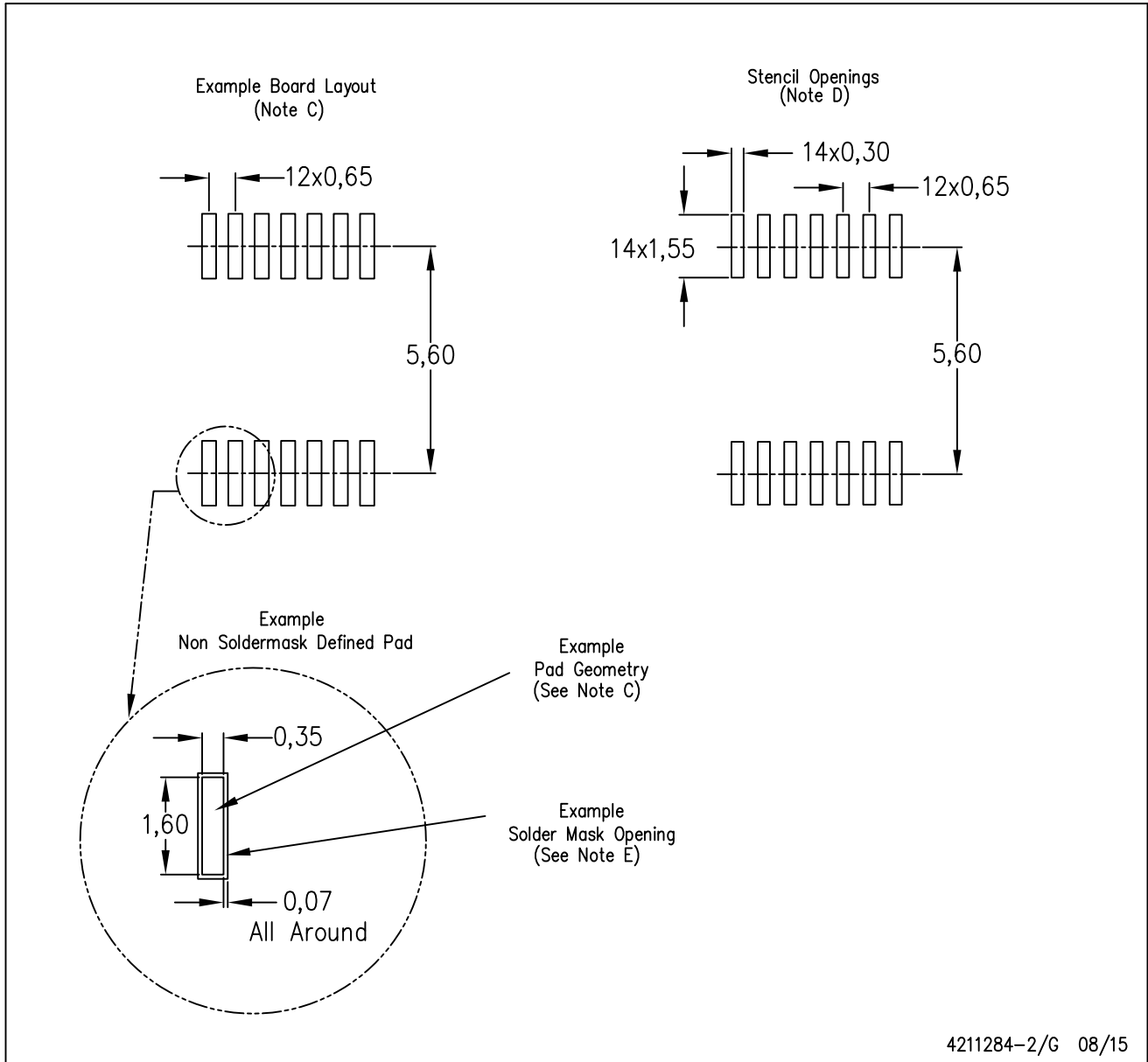

- NOTES:
- All linear dimensions are in millimeters.
 - This drawing is subject to change without notice.
 - Publication IPC-7351 is recommended for alternate designs.
 - Laser cutting apertures with trapezoidal walls and also rounding corners will offer better paste release. Customers should contact their board assembly site for stencil design recommendations. Refer to IPC-7525 for other stencil recommendations.
 - Customers should contact their board fabrication site for solder mask tolerances between and around signal pads.

DB (R-PDSO-G**)

PLASTIC SMALL-OUTLINE

28 PINS SHOWN



- NOTES: A. All linear dimensions are in millimeters.
 B. This drawing is subject to change without notice.
 C. Body dimensions do not include mold flash or protrusion not to exceed 0,15.
 D. Falls within JEDEC MO-150

IMPORTANT NOTICE AND DISCLAIMER

TI PROVIDES TECHNICAL AND RELIABILITY DATA (INCLUDING DATA SHEETS), DESIGN RESOURCES (INCLUDING REFERENCE DESIGNS), APPLICATION OR OTHER DESIGN ADVICE, WEB TOOLS, SAFETY INFORMATION, AND OTHER RESOURCES "AS IS" AND WITH ALL FAULTS, AND DISCLAIMS ALL WARRANTIES, EXPRESS AND IMPLIED, INCLUDING WITHOUT LIMITATION ANY IMPLIED WARRANTIES OF MERCHANTABILITY, FITNESS FOR A PARTICULAR PURPOSE OR NON-INFRINGEMENT OF THIRD PARTY INTELLECTUAL PROPERTY RIGHTS.

These resources are intended for skilled developers designing with TI products. You are solely responsible for (1) selecting the appropriate TI products for your application, (2) designing, validating and testing your application, and (3) ensuring your application meets applicable standards, and any other safety, security, regulatory or other requirements.

These resources are subject to change without notice. TI grants you permission to use these resources only for development of an application that uses the TI products described in the resource. Other reproduction and display of these resources is prohibited. No license is granted to any other TI intellectual property right or to any third party intellectual property right. TI disclaims responsibility for, and you will fully indemnify TI and its representatives against, any claims, damages, costs, losses, and liabilities arising out of your use of these resources.

TI's products are provided subject to [TI's Terms of Sale](#) or other applicable terms available either on [ti.com](https://www.ti.com) or provided in conjunction with such TI products. TI's provision of these resources does not expand or otherwise alter TI's applicable warranties or warranty disclaimers for TI products.

TI objects to and rejects any additional or different terms you may have proposed.

Mailing Address: Texas Instruments, Post Office Box 655303, Dallas, Texas 75265
Copyright © 2023, Texas Instruments Incorporated

单击下面可查看定价，库存，交付和生命周期等信息

[>>TI\(德州仪器\)](#)