

OPAx197 36-V, Precision, Rail-to-Rail Input/Output, Low Offset Voltage, Operational Amplifiers

1 Features

- Low Offset Voltage: $\pm 100 \mu\text{V}$ (Maximum)
- Low Offset Voltage Drift: $\pm 2.5 \mu\text{V}/^\circ\text{C}$ (Maximum)
- Low Noise: $5.5 \text{ nV}/\sqrt{\text{Hz}}$ at 1 kHz
- High Common-Mode Rejection: 120 dB (Minimum)
- Low Bias Current: $\pm 5 \text{ pA}$ (Typical)
- Rail-to-Rail Input and Output
- Wide Bandwidth: 10-MHz GBW
- High Slew Rate: 20 V/ μs
- Low Quiescent Current: 1 mA per Amplifier (Typical)
- Wide Supply: $\pm 2.25 \text{ V}$ to $\pm 18 \text{ V}$, $+4.5 \text{ V}$ to $+36 \text{ V}$
- EMI- and RFI-Filtered Inputs
- Differential Input Voltage Range to Supply Rail
- High Capacitive Load Drive Capability: 1 nF
- Industry Standard Packages:
 - Single in SOIC-8, SOT-5, and VSSOP-8
 - Dual in SOIC-8 and VSSOP-8
 - Quad in SOIC-14 and TSSOP-14

2 Applications

- Multiplexed Data-Acquisition Systems
- Test and Measurement Equipment
- High-Resolution ADC Driver Amplifiers
- SAR ADC Reference Buffers
- Programmable Logic Controllers
- High-Side and Low-Side Current Sensing
- High Precision Comparators

3 Description

The OPAx197 family (OPA197, OPA2197, and OPA4197) is a new generation of 36-V operational amplifiers.

These devices offer outstanding dc precision and ac performance, including rail-to-rail input/output, low offset ($\pm 25 \mu\text{V}$, typical), low offset drift ($\pm 0.25 \mu\text{V}/^\circ\text{C}$, typ), and 10-MHz bandwidth.

Unique features such as differential input-voltage range to the supply rail, high output current ($\pm 65 \text{ mA}$), high capacitive load drive of up to 1 nF, and high slew rate (20 V/ μs) make the OPA197 a robust, high-performance operational amplifier for high-voltage, industrial applications.

The OPA197 family of op amps is available in standard packages and is specified from -40°C to $+125^\circ\text{C}$.

Device Information⁽¹⁾

PART NUMBER	PACKAGE	BODY SIZE (NOM)
OPA197	SOIC (8)	4.90 mm x 3.90 mm
	SOT (5)	2.90 mm x 1.60 mm
	VSSOP (8)	3.00 mm x 3.00 mm
OPA2197	SOIC (8)	4.90 mm x 3.90 mm
	VSSOP (8)	3.00 mm x 3.00 mm
OPA4197	SOIC (14)	8.65 mm x 3.90 mm
	TSSOP (14)	5.00 mm x 4.40 mm

(1) For all available packages, see the package option addendum at the end of the data sheet.

OPA197 in a High-Voltage, Multiplexed, Data-Acquisition System

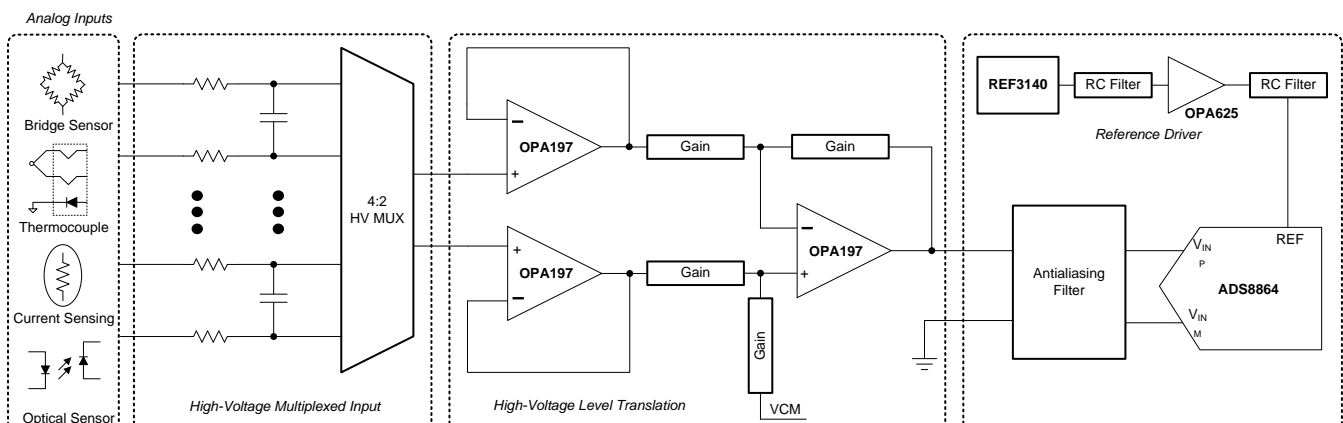

Table of Contents

1 Features	1	7.3 Feature Description.....	20
2 Applications	1	7.4 Device Functional Modes.....	26
3 Description	1	8 Application and Implementation	27
4 Revision History	2	8.1 Application Information.....	27
5 Pin Configuration and Functions	3	8.2 Typical Applications	27
6 Specifications	5	9 Power Supply Recommendations	30
6.1 Absolute Maximum Ratings	5	10 Layout	31
6.2 ESD Ratings.....	5	10.1 Layout Guidelines	31
6.3 Recommended Operating Conditions.....	5	10.2 Layout Example	31
6.4 Thermal Information: OPA197	6	11 Device and Documentation Support	32
6.5 Thermal Information: OPA2197	6	11.1 Device Support.....	32
6.6 Thermal Information: OPA4197	6	11.2 Documentation Support	32
6.7 Electrical Characteristics: $V_S = \pm 4\text{ V to } \pm 18\text{ V}$ ($V_S = 8\text{ V to } 36\text{ V}$).....	7	11.3 Related Links	32
6.8 Electrical Characteristics: $V_S = \pm 2.25\text{ V to } \pm 4\text{ V}$ ($V_S = 4.5\text{ V to } 8\text{ V}$).....	9	11.4 Receiving Notification of Documentation Updates.....	33
6.9 Typical Characteristics	11	11.5 Community Resources.....	33
7 Detailed Description	19	11.6 Trademarks	33
7.1 Overview	19	11.7 Electrostatic Discharge Caution.....	33
7.2 Functional Block Diagram	19	11.8 Glossary	33
		12 Mechanical, Packaging, and Orderable Information	33

4 Revision History

Changes from Revision B (October 2016) to Revision C	Page
• Changed "Low Offset Voltage: $\pm 250\text{ }\mu\text{V}$ (Maximum)" to "Low Offset Voltage: $\pm 100\text{ }\mu\text{V}$ (Maximum)"	1
• Changed <i>Electrical Characteristics: $V_S = \pm 4\text{ V to } \pm 18\text{ V}$ ($V_S = 8\text{ V to } 36\text{ V}$)</i> Input offset voltage $V_S = \pm 18\text{ V}$ under OFFSET VOLTAGE from " ± 250 " to " ± 100 "; remove " $T_A = 0^\circ\text{C to } 85^\circ\text{C}$ " and " $T_A = -40^\circ\text{C to } +125^\circ\text{C}$ " rows from same	7
• Changed <i>Electrical Characteristics: $V_S = \pm 4\text{ V to } \pm 18\text{ V}$ ($V_S = 8\text{ V to } 36\text{ V}$)</i> Input offset voltage $V_{CM} = (V+) - 1.5\text{ V}$ under OFFSET VOLTAGE from " ± 250 " to " ± 100 "; remove " $T_A = 0^\circ\text{C to } 85^\circ\text{C}$ " and " $T_A = -40^\circ\text{C to } +125^\circ\text{C}$ " rows from same.....	7
• Changed <i>Electrical Characteristics: $V_S = \pm 2.25\text{ V to } \pm 4\text{ V}$ ($V_S = 4.5\text{ V to } 8\text{ V}$)</i> Input offset voltage $V_S = \pm 2.25\text{ V}$, $V_{CM} = (V+) - 3\text{ V}$ under OFFSET VOLTAGE from " ± 250 " to " ± 100 "; remove " $T_A = 0^\circ\text{C to } 85^\circ\text{C}$ " and " $T_A = -40^\circ\text{C to } +125^\circ\text{C}$ " rows from same.....	9
• Changed <i>Electrical Characteristics: $V_S = \pm 4\text{ V to } \pm 18\text{ V}$ ($V_S = 8\text{ V to } 36\text{ V}$)</i> Input offset voltage $V_S = \pm 3\text{ V}$, $V_{CM} = (V+) - 1.5\text{ V}$ under OFFSET VOLTAGE from " ± 250 " to " ± 100 "; remove " $T_A = 0^\circ\text{C to } 85^\circ\text{C}$ " and " $T_A = -40^\circ\text{C to } +125^\circ\text{C}$ " rows from same.....	9
• Changed "0" on Frequency (Hz) axis to "0.1"	11
• Changed "...to achieve a very low offset voltage of $250\text{ }\mu\text{V}$ (max)..." to "...to achieve a very low offset voltage of $100\text{ }\mu\text{V}$ (maximum)..."	19

Changes from Revision A (July 2016) to Revision B	Page
• Added new row for PW package to <i>Input bias current</i> parameter	7
• Added new row for PW package to <i>Input offset current</i> parameter	7
• Added new footnote (1) to <i>Open-loop gain</i> parameter.....	7
• Changed <i>Slew rate</i> parameter from $20\text{ V}/\mu\text{s}$: to $14\text{ V}/\mu\text{s}$	10

Changes from Original (January 2016) to Revision A	Page
• Added OPA2197 and OPA4197 CDM values to ESD Ratings table.....	5

5 Pin Configuration and Functions

D and DGK Packages: OPA197
8-Pin SOIC and VSSOP
Top View

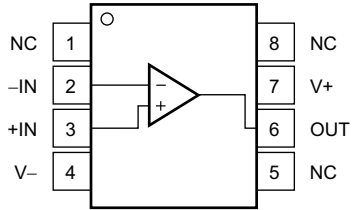

D and DGK Packages: OPA2197
8-Pin SOIC and VSSOP
Top View

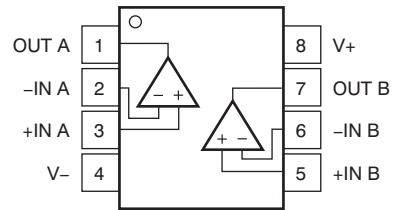

DBV Package: OPA197
5-Pin SOT
Top View

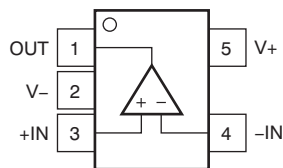

D and PW Packages: OPA4197
14-Pin SOIC and TSSOP
Top View

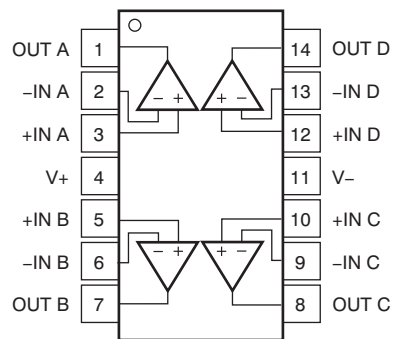

Pin Functions: OPA197

PIN			I/O	DESCRIPTION
NAME	OPA197			
	D (SOIC), DGK (VSSOP)	DBV (SOT)		
+IN	3	3	I	Noninverting input
–IN	2	4	I	Inverting input
NC	1, 5, 8	—	—	No internal connection (can be left floating)
OUT	6	1	O	Output
V+	7	5	—	Positive (highest) power supply
V–	4	2	—	Negative (lowest) power supply

Pin Functions: OPA2197 and OPA4197

PIN			I/O	DESCRIPTION
NAME	OPA2197	OPA4197		
	D (SOIC), DGK (VSSOP)	D (SOIC), PW (TSSOP)		
+IN A	3	3	I	Noninverting input, channel A
+IN B	5	5	I	Noninverting input, channel B
+IN C	—	10	I	Noninverting input, channel C
+IN D	—	12	I	Noninverting input, channel D
–IN A	2	2	I	Inverting input, channel A
–IN B	6	6	I	Inverting input, channel B
–IN C	—	9	I	Inverting input, channel C
–IN D	—	13	I	Inverting input, channel D
OUT A	1	1	O	Output, channel A
OUT B	7	7	O	Output, channel B
OUT C	—	8	O	Output, channel C
OUT D	—	14	O	Output, channel D
V+	8	4	—	Positive (highest) power supply
V–	4	11	—	Negative (lowest) power supply

6 Specifications

6.1 Absolute Maximum Ratings⁽¹⁾

over operating free-air temperature range (unless otherwise noted)

		MIN	MAX	UNIT	
Supply voltage, $V_S = (V+) - (V-)$	Dual supply		±20	V	
	Single supply		40		
Signal input pins	Voltage	Common-mode	(V-) – 0.5	(V+) + 0.5	V
		Differential		(V+) – (V-) + 0.2	
	Current		±10	mA	
Output short circuit ⁽²⁾		Continuous			
Temperature	Operating, T_A	–55	150	°C	
	Junction, T_J		150		
	Storage, T_{stg}	–65	150		

- (1) Stresses beyond those listed under *Absolute Maximum Ratings* may cause permanent damage to the device. These are stress ratings only, which do not imply functional operation of the device at these or any other conditions beyond those indicated under *Recommended Operating Conditions*. Exposure to absolute-maximum-rated conditions for extended periods may affect device reliability.
- (2) Short-circuit to ground, one amplifier per package.

6.2 ESD Ratings

			VALUE	UNIT
ALL DEVICES				
$V_{(ESD)}$	Electrostatic discharge	Human-body model (HBM), per ANSI/ESDA/JEDEC JS-001 ⁽¹⁾	±4000	V
OPA197				
$V_{(ESD)}$	Electrostatic discharge	Charged-device model (CDM), per JEDEC specification JESD22-C101 ⁽²⁾	±1000	V
OPA2197				
$V_{(ESD)}$	Electrostatic discharge	Charged-device model (CDM), per JEDEC specification JESD22-C101 ⁽²⁾	±750	V
OPA4197				
$V_{(ESD)}$	Electrostatic discharge	Charged-device model (CDM), per JEDEC specification JESD22-C101 ⁽²⁾	±500	V

- (1) JEDEC document JEP155 states that 500-V HBM allows safe manufacturing with a standard ESD control process.
- (2) JEDEC document JEP157 states that 250-V CDM allows safe manufacturing with a standard ESD control process.

6.3 Recommended Operating Conditions

over operating free-air temperature range (unless otherwise noted)

		MIN	NOM	MAX	UNIT
Supply voltage, $V_S = (V+) - (V-)$	Dual supply	±2.25		±18	V
	Single supply	4.5		36	
Operating temperature, T_A		–40		125	°C

6.4 Thermal Information: OPA197

THERMAL METRIC ⁽¹⁾		OPA197			UNIT
		D (SOIC)	DBV (SOT)	DGK (VSSOP)	
		8 PINS	5 PINS	8 PINS	
$R_{\theta JA}$	Junction-to-ambient thermal resistance	115.8	158.8	180.4	°C/W
$R_{\theta JC(top)}$	Junction-to-case(top) thermal resistance	60.1	60.7	67.9	°C/W
$R_{\theta JB}$	Junction-to-board thermal resistance	56.4	44.8	102.1	°C/W
Ψ_{JT}	Junction-to-top characterization parameter	12.8	1.6	10.4	°C/W
Ψ_{JB}	Junction-to-board characterization parameter	55.9	4.2	100.3	°C/W
$R_{\theta JC(bot)}$	Junction-to-case(bottom) thermal resistance	N/A	N/A	N/A	°C/W

(1) For more information about traditional and new thermal metrics, see the [Semiconductor and IC Package Thermal Metrics](#) application report.

6.5 Thermal Information: OPA2197

THERMAL METRIC ⁽¹⁾		OPA2197		UNIT
		D (SOIC)	DGK (VSSOP)	
		8 PINS	8 PINS	
$R_{\theta JA}$	Junction-to-ambient thermal resistance	107.9	158	°C/W
$R_{\theta JC(top)}$	Junction-to-case(top) thermal resistance	53.9	48.6	°C/W
$R_{\theta JB}$	Junction-to-board thermal resistance	48.9	78.7	°C/W
Ψ_{JT}	Junction-to-top characterization parameter	6.6	3.9	°C/W
Ψ_{JB}	Junction-to-board characterization parameter	48.3	77.3	°C/W
$R_{\theta JC(bot)}$	Junction-to-case(bottom) thermal resistance	N/A	N/A	°C/W

(1) For more information about traditional and new thermal metrics, see the [Semiconductor and IC Package Thermal Metrics](#) application report.

6.6 Thermal Information: OPA4197

THERMAL METRIC ⁽¹⁾		OPA4197		UNIT
		D (SOIC)	PW (TSSOP)	
		14 PINS	14 PINS	
$R_{\theta JA}$	Junction-to-ambient thermal resistance	86.4	92.6	°C/W
$R_{\theta JC(top)}$	Junction-to-case(top) thermal resistance	46.3	27.5	°C/W
$R_{\theta JB}$	Junction-to-board thermal resistance	41.0	33.6	°C/W
Ψ_{JT}	Junction-to-top characterization parameter	11.3	1.9	°C/W
Ψ_{JB}	Junction-to-board characterization parameter	40.7	33.1	°C/W
$R_{\theta JC(bot)}$	Junction-to-case(bottom) thermal resistance	N/A	N/A	°C/W

(1) For more information about traditional and new thermal metrics, see the [Semiconductor and IC Package Thermal Metrics](#) application report.

6.7 Electrical Characteristics: $V_S = \pm 4\text{ V to } \pm 18\text{ V}$ ($V_S = 8\text{ V to } 36\text{ V}$)

at $T_A = 25^\circ\text{C}$, $V_{CM} = V_{OUT} = V_S / 2$, and $R_{LOAD} = 10\text{ k}\Omega$ connected to $V_S / 2$, (unless otherwise noted)

PARAMETER		TEST CONDITIONS		MIN	TYP	MAX	UNIT
OFFSET VOLTAGE							
V_{OS}	Input offset voltage	$V_S = \pm 18\text{ V}$			± 25	± 100	μV
		$V_{CM} = (V+) - 1.5\text{ V}$			± 10	± 100	
dV_{OS}/dT	Input offset voltage drift	$V_S = \pm 18\text{ V}$, $V_{CM} = (V+) - 3\text{ V}$	$T_A = -40^\circ\text{C to } +125^\circ\text{C}$		± 0.5	± 2.5	$\mu\text{V}/^\circ\text{C}$
		$V_S = \pm 18\text{ V}$, $V_{CM} = (V+) - 1.5\text{ V}$			± 0.8	± 4.5	
PSRR	Power-supply rejection ratio	$T_A = -40^\circ\text{C to } +125^\circ\text{C}$			± 1	± 3	$\mu\text{V/V}$
INPUT BIAS CURRENT							
I_B	Input bias current	$T_A = -40^\circ\text{C to } +125^\circ\text{C}$			± 5	± 20	pA
		PW package only				± 5	
I_{OS}	Input offset current	$T_A = -40^\circ\text{C to } +125^\circ\text{C}$			± 2	± 20	pA
		PW package only				± 2	
NOISE							
E_n	Input voltage noise	$(V-) - 0.1\text{ V} < V_{CM} < (V+) - 3\text{ V}$	$f = 0.1\text{ Hz to } 10\text{ Hz}$		1.30		μV_{PP}
		$(V+) - 1.5\text{ V} < V_{CM} < (V+) + 0.1\text{ V}$	$f = 0.1\text{ Hz to } 10\text{ Hz}$		4		
e_n	Input voltage noise density	$(V-) - 0.1\text{ V} < V_{CM} < (V+) - 3\text{ V}$	$f = 100\text{ Hz}$		10.5		$\text{nV}/\sqrt{\text{Hz}}$
			$f = 1\text{ kHz}$		5.5		
		$(V+) - 1.5\text{ V} < V_{CM} < (V+) + 0.1\text{ V}$	$f = 100\text{ Hz}$		32		
			$f = 1\text{ kHz}$		12.5		
i_n	Input current noise density	$f = 1\text{ kHz}$			1.5		$\text{fA}/\sqrt{\text{Hz}}$
INPUT VOLTAGE							
V_{CM}	Common-mode voltage range			$(V-) - 0.1$		$(V+) + 0.1$	V
CMRR	Common-mode rejection ratio	$V_S = \pm 18\text{ V}$, $(V-) - 0.1\text{ V} < V_{CM} < (V+) - 3\text{ V}$	$T_A = -40^\circ\text{C to } +125^\circ\text{C}$		120	140	dB
				110	126		
		$V_S = \pm 18\text{ V}$, $(V+) - 1.5\text{ V} < V_{CM} < (V+) + 0.1\text{ V}$		100	120		
		$V_S = \pm 18\text{ V}$, $(V+) - 3\text{ V} < V_{CM} < (V+) - 1.5\text{ V}$			80	100	
				See Typical Characteristics			
INPUT IMPEDANCE							
Z_{ID}	Differential				100 1.6		$\text{M}\Omega \parallel \text{pF}$
Z_{IC}	Common-mode				1 6.4		$10^{13}\Omega \parallel \text{pF}$
OPEN-LOOP GAIN							
A_{OL}	Open-loop voltage gain ⁽¹⁾	$V_S = \pm 18\text{ V}$, $(V-) + 0.6\text{ V} < V_O < (V+) - 0.6\text{ V}$, $R_{LOAD} = 2\text{ k}\Omega$	$T_A = -40^\circ\text{C to } +125^\circ\text{C}$		120	134	dB
				110	126		
		$V_S = \pm 18\text{ V}$, $(V-) + 0.3\text{ V} < V_O < (V+) - 0.3\text{ V}$, $R_{LOAD} = 10\text{ k}\Omega$	$T_A = -40^\circ\text{C to } +125^\circ\text{C}$		120	143	
				110	134		

(1) For OPA2197, OPA4197: When driving high current loads on multiple channels, make sure the junction temperature does not exceed 125°C .

Electrical Characteristics: $V_S = \pm 4\text{ V}$ to $\pm 18\text{ V}$ ($V_S = 8\text{ V}$ to 36 V) (continued)

 at $T_A = 25^\circ\text{C}$, $V_{CM} = V_{OUT} = V_S / 2$, and $R_{LOAD} = 10\text{ k}\Omega$ connected to $V_S / 2$, (unless otherwise noted)

PARAMETER		TEST CONDITIONS		MIN	TYP	MAX	UNIT
FREQUENCY RESPONSE							
GBW	Unity gain bandwidth				10		MHz
SR	Slew rate	$V_S = \pm 18\text{ V}$, $G = 1$, 10-V step			20		V/ μs
t_s	Settling time	To 0.01%	$V_S = \pm 18\text{ V}$, $G = 1$, 10-V step		1.4		μs
			$V_S = \pm 18\text{ V}$, $G = 1$, 5-V step		0.9		
		To 0.001%	$V_S = \pm 18\text{ V}$, $G = 1$, 10-V step		2.1		
			$V_S = \pm 18\text{ V}$, $G = 1$, 5-V step		1.8		
t_{OR}	Overload recovery time	$V_{IN} \times G = V_S$			200		ns
THD+N	Total harmonic distortion + noise	$G = 1$, $f = 1\text{ kHz}$, $V_O = 3.5\text{ V}_{RMS}$			0.00008%		
OUTPUT							
V_O	Voltage output swing from rail	Positive rail	No load		5	25	mV
			$R_{LOAD} = 10\text{ k}\Omega$		95	125	
			$R_{LOAD} = 2\text{ k}\Omega$		430	500	
		Negative rail	No load		5	25	
			$R_{LOAD} = 10\text{ k}\Omega$		95	125	
			$R_{LOAD} = 2\text{ k}\Omega$		430	500	
I_{SC}	Short-circuit current	$V_S = \pm 18\text{ V}$			± 65		mA
C_{LOAD}	Capacitive load drive				See Typical Characteristics		
Z_O	Open-loop output impedance	$f = 1\text{ MHz}$, $I_O = 0\text{ A}$, See Figure 26			375		Ω
POWER SUPPLY							
I_Q	Quiescent current per amplifier	$I_O = 0\text{ A}$			1	1.3	mA
		$T_A = -40^\circ\text{C}$ to $+125^\circ\text{C}$, $I_O = 0\text{ A}$				1.5	
TEMPERATURE							
	Thermal protection ⁽²⁾				140		$^\circ\text{C}$

 (2) For a detailed description of thermal protection, see the [Thermal Protection](#) section.

6.8 Electrical Characteristics: $V_S = \pm 2.25\text{ V}$ to $\pm 4\text{ V}$ ($V_S = 4.5\text{ V}$ to 8 V)

 at $T_A = 25^\circ\text{C}$, $V_{CM} = V_{OUT} = V_S / 2$, and $R_{LOAD} = 10\text{ k}\Omega$ connected to $V_S / 2$ (unless otherwise noted)

PARAMETER		TEST CONDITIONS		MIN	TYP	MAX	UNIT
OFFSET VOLTAGE							
V_{OS}	Input offset voltage	$V_S = \pm 2.25\text{ V}$, $V_{CM} = (V+) - 3\text{ V}$			± 5	± 100	μV
		$(V+) - 3.5\text{ V} < V_{CM} < (V+) - 1.5\text{ V}$		See Common-Mode Voltage Range section			
		$V_S = \pm 3\text{ V}$, $V_{CM} = (V+) - 1.5\text{ V}$			± 10	± 100	μV
dV_{OS}/dT	Input offset voltage drift	$V_S = \pm 2.25\text{ V}$, $V_{CM} = (V+) - 3\text{ V}$		$T_A = -40^\circ\text{C}$ to $+125^\circ\text{C}$	± 0.5	± 2.5	$\mu\text{V}/^\circ\text{C}$
		$V_S = \pm 2.25\text{ V}$, $V_{CM} = (V+) - 1.5\text{ V}$			± 0.8	± 4.5	
PSRR	Power-supply rejection ratio	$T_A = -40^\circ\text{C}$ to $+125^\circ\text{C}$, $V_{CM} = V_S / 2 - 0.75\text{ V}$			± 2		$\mu\text{V}/\text{V}$
INPUT BIAS CURRENT							
I_B	Input bias current				± 5	± 20	pA
		$T_A = -40^\circ\text{C}$ to $+125^\circ\text{C}$				± 5	nA
I_{OS}	Input offset current				± 2	± 20	pA
		$T_A = -40^\circ\text{C}$ to $+125^\circ\text{C}$				± 2	nA
NOISE							
E_n	Input voltage noise	$(V-) - 0.1\text{ V} < V_{CM} < (V+) - 3\text{ V}$, $f = 0.1\text{ Hz}$ to 10 Hz			1.30		μV_{PP}
		$(V+) - 1.5\text{ V} < V_{CM} < (V+) + 0.1\text{ V}$, $f = 0.1\text{ Hz}$ to 10 Hz			4		
e_n	Input voltage noise density	$(V-) - 0.1\text{ V} < V_{CM} < (V+) - 3\text{ V}$	$f = 100\text{ Hz}$		10.5		$\text{nV}/\sqrt{\text{Hz}}$
			$f = 1\text{ kHz}$		5.5		
		$(V+) - 1.5\text{ V} < V_{CM} < (V+) + 0.1\text{ V}$	$f = 100\text{ Hz}$		32		
			$f = 1\text{ kHz}$		12.5		
i_n	Input current noise density				1.5		$\text{fA}/\sqrt{\text{Hz}}$
INPUT VOLTAGE							
V_{CM}	Common-mode voltage range			$(V-) - 0.1$		$(V+) + 0.1$	V
CMRR	Common-mode rejection ratio	$V_S = \pm 2.25\text{ V}$, $(V-) - 0.1\text{ V} < V_{CM} < (V+) - 3\text{ V}$	$T_A = -40^\circ\text{C}$ to $+125^\circ\text{C}$	90	110		dB
			$T_A = -40^\circ\text{C}$ to $+125^\circ\text{C}$	88	104		
		$V_S = \pm 2.25\text{ V}$, $(V+) - 1.5\text{ V} < V_{CM} < (V+)$	$T_A = -40^\circ\text{C}$ to $+125^\circ\text{C}$	94	120		
			$T_A = -40^\circ\text{C}$ to $+125^\circ\text{C}$	77	100		
		$V_S = \pm 2.25\text{ V}$, $(V+) - 3\text{ V} < V_{CM} < (V+) - 1.5\text{ V}$		See Typical Characteristics			
INPUT IMPEDANCE							
Z_{ID}	Differential				$100 \parallel 1.6$		$\text{M}\Omega \parallel \text{pF}$
Z_{IC}	Common-mode				$1 \parallel 6.4$		$10^{13}\Omega \parallel \text{pF}$
OPEN-LOOP GAIN							
A_{OL}	Open-loop voltage gain	$V_S = \pm 2.25\text{ V}$, $(V-) + 0.6\text{ V} < V_O < (V+) - 0.6\text{ V}$, $R_{LOAD} = 2\text{ k}\Omega$	$T_A = -40^\circ\text{C}$ to $+125^\circ\text{C}$	104	126		dB
			$T_A = -40^\circ\text{C}$ to $+125^\circ\text{C}$	100	114		
		$V_S = \pm 2.25\text{ V}$, $(V-) + 0.3\text{ V} < V_O < (V+) - 0.3\text{ V}$, $R_{LOAD} = 10\text{ k}\Omega$	$T_A = -40^\circ\text{C}$ to $+125^\circ\text{C}$	104	134		
			$T_A = -40^\circ\text{C}$ to $+125^\circ\text{C}$	100	120		

Electrical Characteristics: $V_S = \pm 2.25\text{ V}$ to $\pm 4\text{ V}$ ($V_S = 4.5\text{ V}$ to 8 V) (continued)

at $T_A = 25^\circ\text{C}$, $V_{CM} = V_{OUT} = V_S / 2$, and $R_{LOAD} = 10\text{ k}\Omega$ connected to $V_S / 2$ (unless otherwise noted)

PARAMETER		TEST CONDITIONS		MIN	TYP	MAX	UNIT
FREQUENCY RESPONSE							
GBW	Unity gain bandwidth				10		MHz
SR	Slew rate	G = 1, 1-V step			14		V/ μs
t_s	Settling time	To 0.01%	$V_S = \pm 3\text{ V}$, G = 1, 5-V step		1		μs
t_{OR}	Overload recovery time	$V_{IN} \times G = V_S$			200		ns
OUTPUT							
V_O	Voltage output swing from rail	Positive rail	No load		5	25	mV
			$R_{LOAD} = 10\text{ k}\Omega$		95	125	
			$R_{LOAD} = 2\text{ k}\Omega$		430	500	
		Negative rail	No load		5	25	
			$R_{LOAD} = 10\text{ k}\Omega$		95	125	
			$R_{LOAD} = 2\text{ k}\Omega$		430	500	
I_{SC}	Short-circuit current	$V_S = \pm 2.25\text{ V}$			± 65		mA
C_{LOAD}	Capacitive load drive			See Typical Characteristics			
Z_O	Open-loop output impedance	f = 1 MHz, $I_O = 0\text{ A}$, see Figure 26			375		Ω
POWER SUPPLY							
I_Q	Quiescent current per amplifier	$I_O = 0\text{ A}$			1	1.3	mA
				$T_A = -40^\circ\text{C}$ to $+125^\circ\text{C}$		1.5	
TEMPERATURE							
	Thermal protection ⁽¹⁾				140		$^\circ\text{C}$

(1) For a detailed description of thermal protection, see the [Thermal Protection](#) section.

6.9 Typical Characteristics

Table 1. Table of Graphs

DESCRIPTION	FIGURE
Offset Voltage Production Distribution	Figure 1 , Figure 2 , Figure 3
Offset Voltage Drift Distribution	Figure 4
Offset Voltage vs Temperature	Figure 5
Offset Voltage vs Common-Mode Voltage	Figure 6 , Figure 7 , Figure 8
Offset Voltage vs Power Supply	Figure 9
Open-Loop Gain and Phase vs Frequency	Figure 10
Closed-Loop Gain and Phase vs Frequency	Figure 11
Input Bias Current vs Common-Mode Voltage	Figure 12
Input Bias Current vs Temperature	Figure 13
Output Voltage Swing vs Output Current (maximum supply)	Figure 14 , Figure 15
CMRR and PSRR vs Frequency	Figure 16
CMRR vs Temperature	Figure 17
PSRR vs Temperature	Figure 18
0.1-Hz to 10-Hz Noise	Figure 19
Input Voltage Noise Spectral Density vs Frequency	Figure 20
THD+N Ratio vs Frequency	Figure 21
THD+N vs Output Amplitude	Figure 22
Quiescent Current vs Supply Voltage	Figure 23
Quiescent Current vs Temperature	Figure 24
Open Loop Gain vs Temperature	Figure 25
Open Loop Output Impedance vs Frequency	Figure 26
Small Signal Overshoot vs Capacitive Load (100-mV output step)	Figure 27 , Figure 28
No Phase Reversal	Figure 29
Positive Overload Recovery	Figure 30
Negative Overload Recovery	Figure 31
Small-Signal Step Response (100 mV)	Figure 32 , Figure 33
Large-Signal Step Response	Figure 34
Settling Time	Figure 35 , Figure 36 , ,
Short-Circuit Current vs Temperature	Figure 37
Maximum Output Voltage vs Frequency	Figure 38
Propagation Delay Rising Edge	Figure 39
Propagation Delay Falling Edge	Figure 40

OPA197, OPA2197, OPA4197

SBOS737C – JANUARY 2016 – REVISED MARCH 2018

www.ti.com

at $T_A = 25^\circ\text{C}$, $V_S = \pm 18\text{ V}$, $V_{CM} = V_S / 2$, $R_{LOAD} = 10\text{ k}\Omega$ connected to $V_S / 2$, and $C_L = 100\text{ pF}$ (unless otherwise noted)

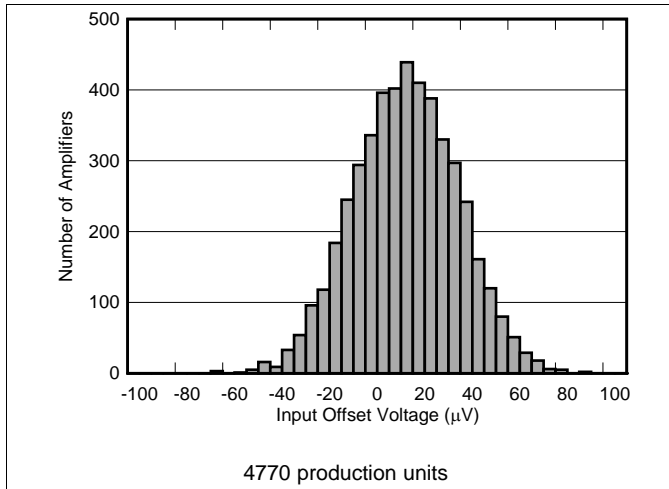

Figure 1. Offset Voltage Production Distribution at 25°C

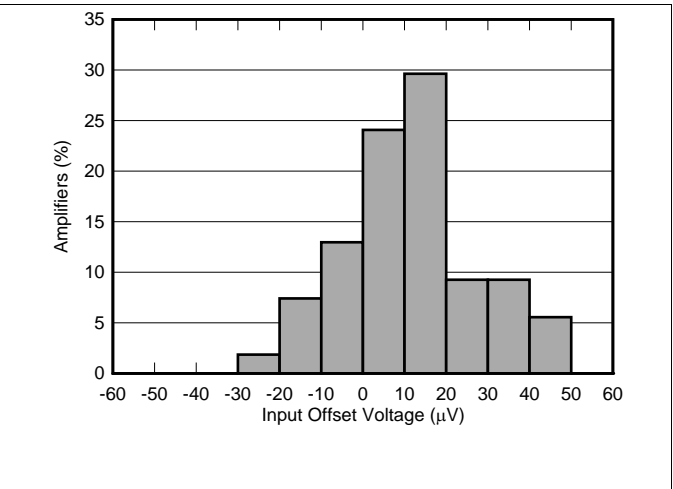

Figure 2. Offset Voltage Production Distribution at 125°C

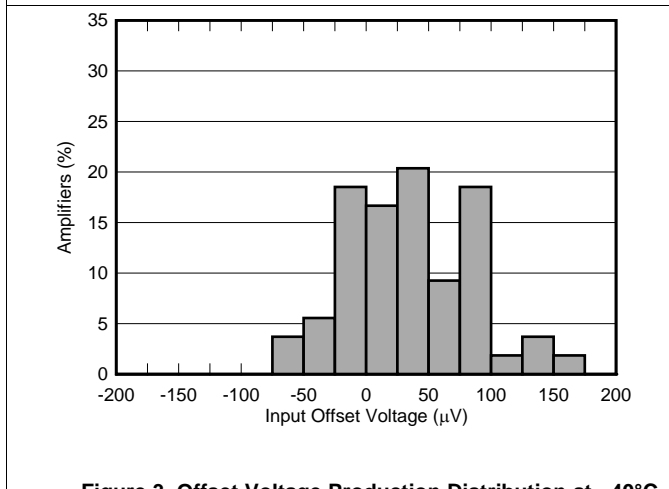

Figure 3. Offset Voltage Production Distribution at -40°C

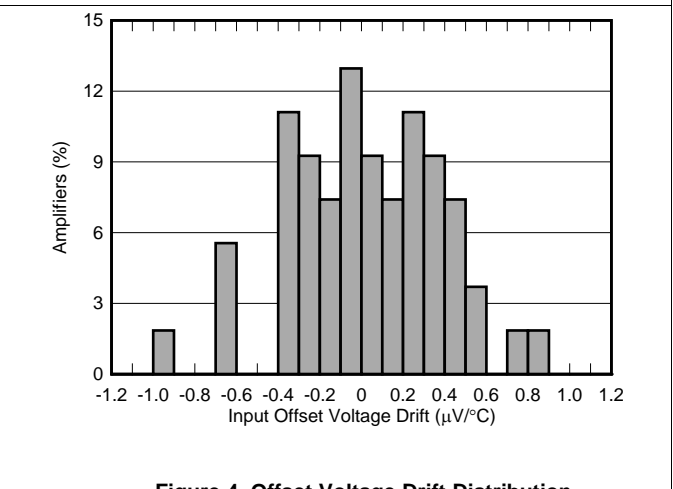

Figure 4. Offset Voltage Drift Distribution from -40°C to +125°C

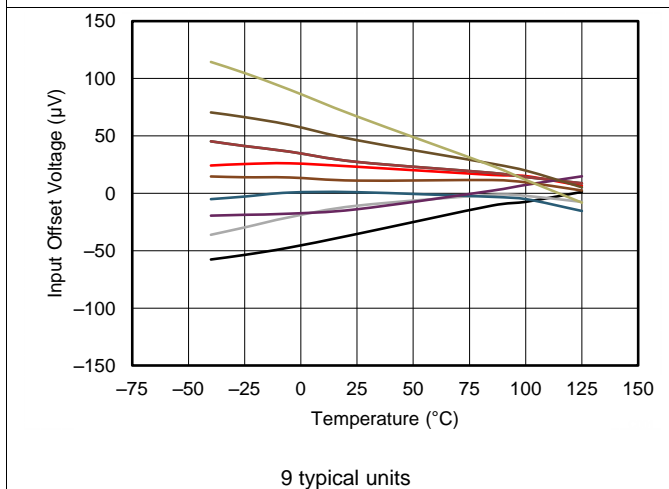

Figure 5. Offset Voltage vs Temperature

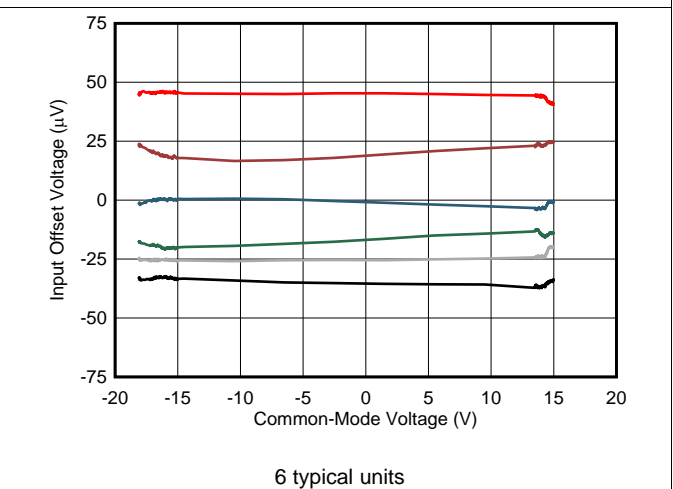
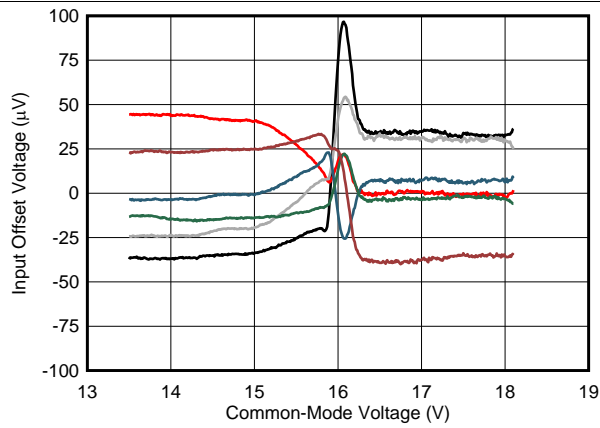

Figure 6. Offset Voltage vs Common-Mode Voltage

at $T_A = 25^\circ\text{C}$, $V_S = \pm 18\text{ V}$, $V_{CM} = V_S / 2$, $R_{LOAD} = 10\text{ k}\Omega$ connected to $V_S / 2$, and $C_L = 100\text{ pF}$ (unless otherwise noted)



6 typical units

Figure 7. Offset Voltage vs Common-Mode Voltage

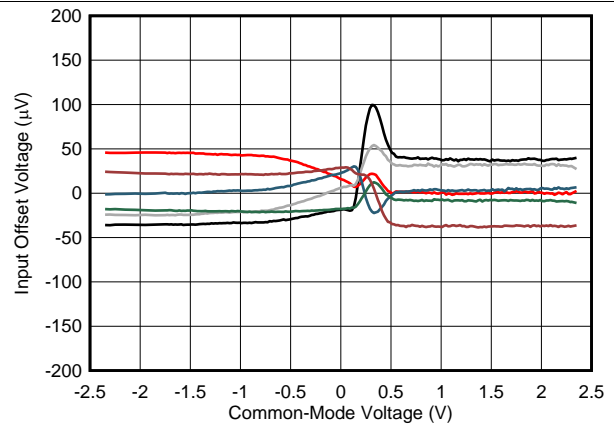

6 typical units

Figure 8. Offset Voltage vs Common-Mode Voltage

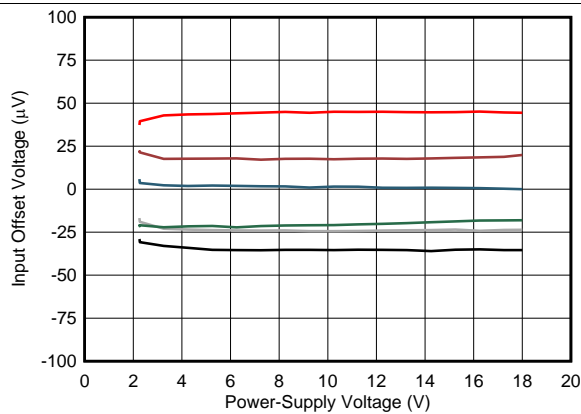

6 typical units

Figure 9. Offset Voltage vs Power Supply

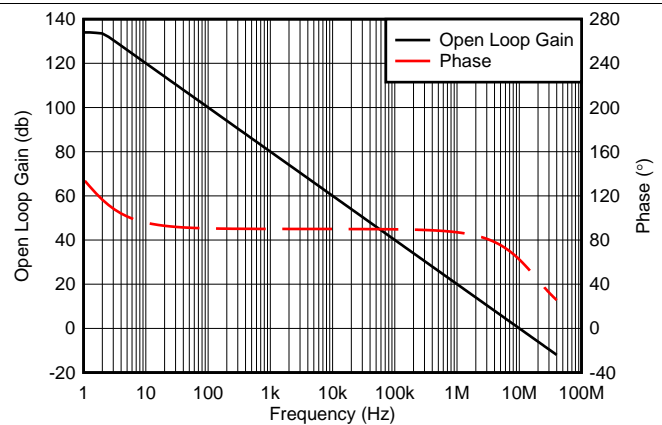

$C_{LOAD} = 15\text{ pF}$

Figure 10. Open-Loop Gain and Phase vs Frequency

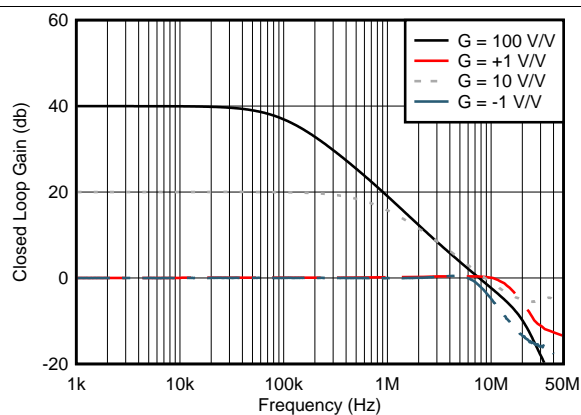

Figure 11. Closed-Loop Gain and Phase vs Frequency

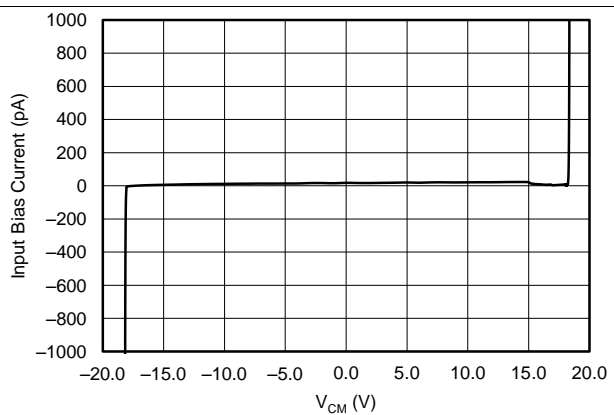

Figure 12. Input Bias Current vs Common-Mode Voltage

OPA197, OPA2197, OPA4197

SBOS737C – JANUARY 2016 – REVISED MARCH 2018

www.ti.com

at $T_A = 25^\circ\text{C}$, $V_S = \pm 18\text{ V}$, $V_{CM} = V_S / 2$, $R_{LOAD} = 10\text{ k}\Omega$ connected to $V_S / 2$, and $C_L = 100\text{ pF}$ (unless otherwise noted)

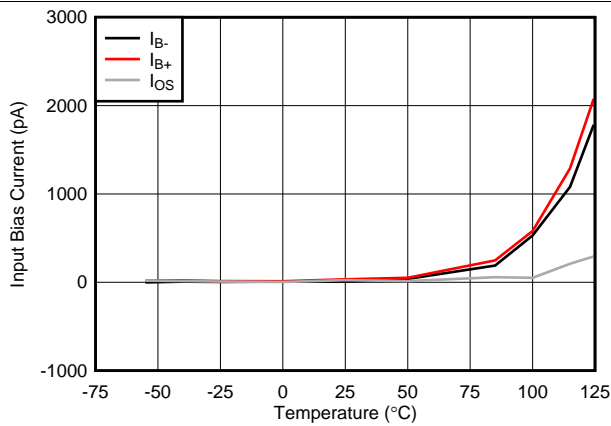

Figure 13. Input Bias Current vs Temperature

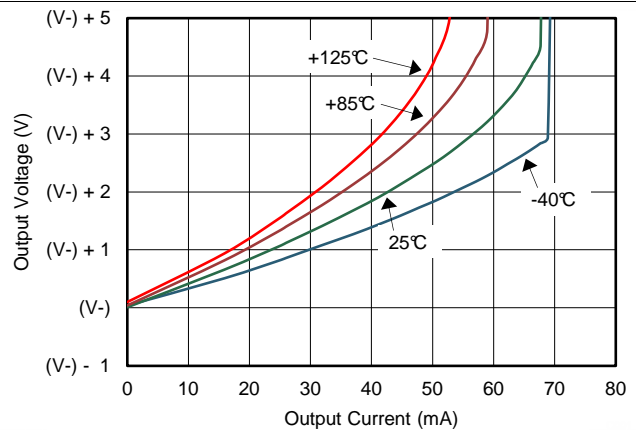

Figure 14. Output Voltage Swing from Negative Power Supply vs Output Current (Maximum Supply)

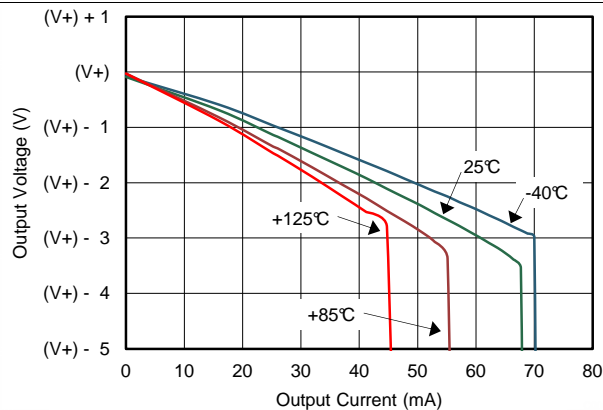

Figure 15. Output Voltage Swing from Positive Power Supply vs Output Current (Maximum Supply)

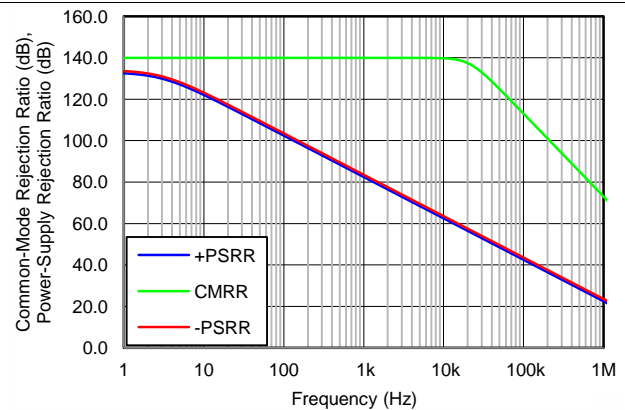

Figure 16. CMRR and PSRR vs Frequency

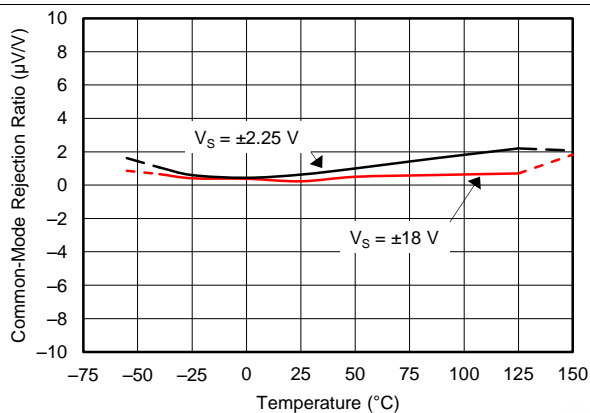

Figure 17. CMRR vs Temperature

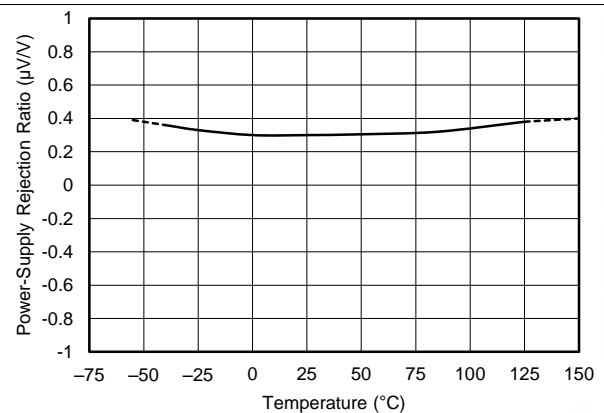
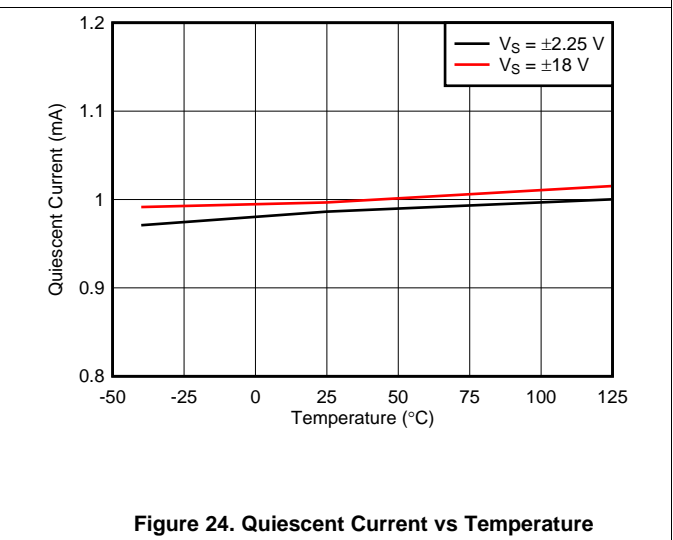
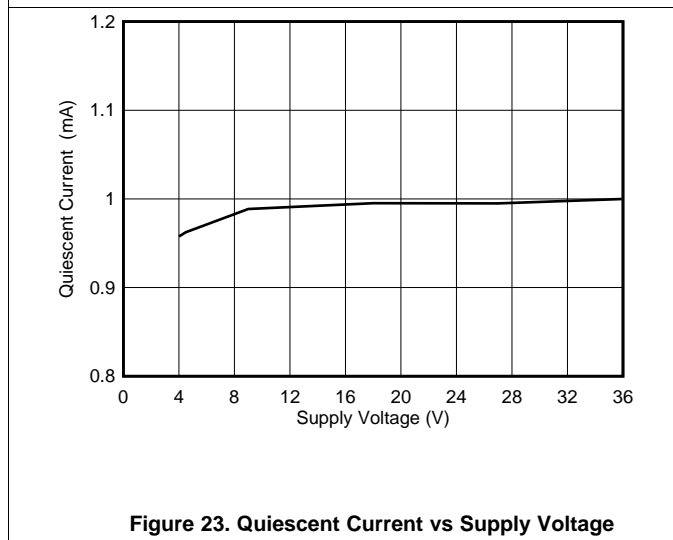
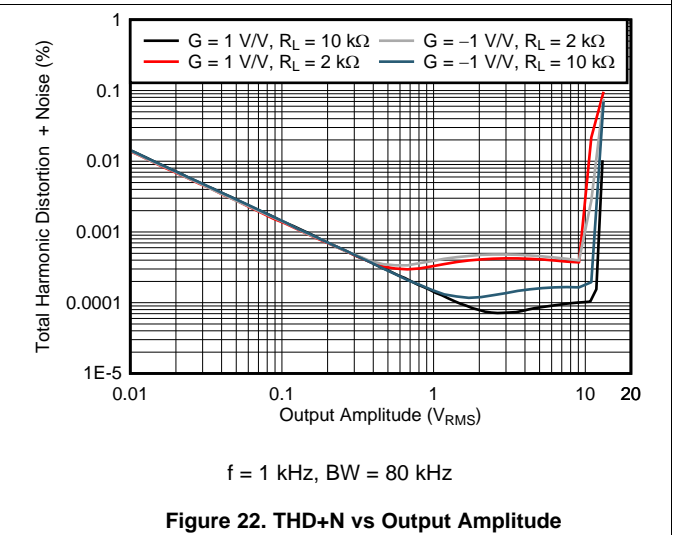
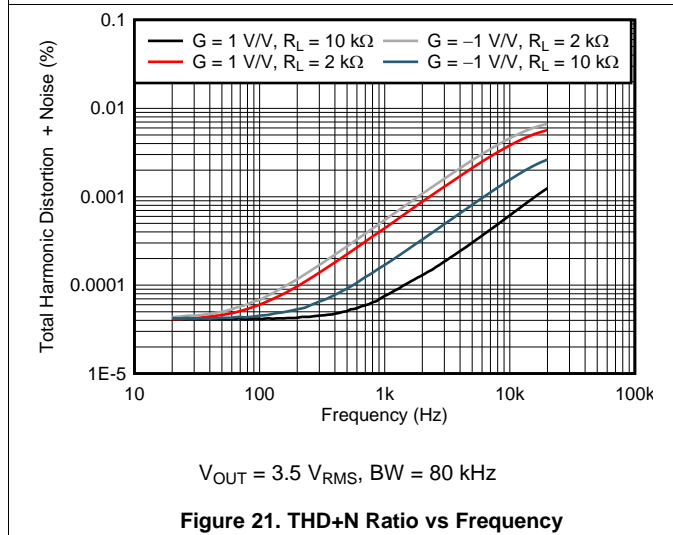
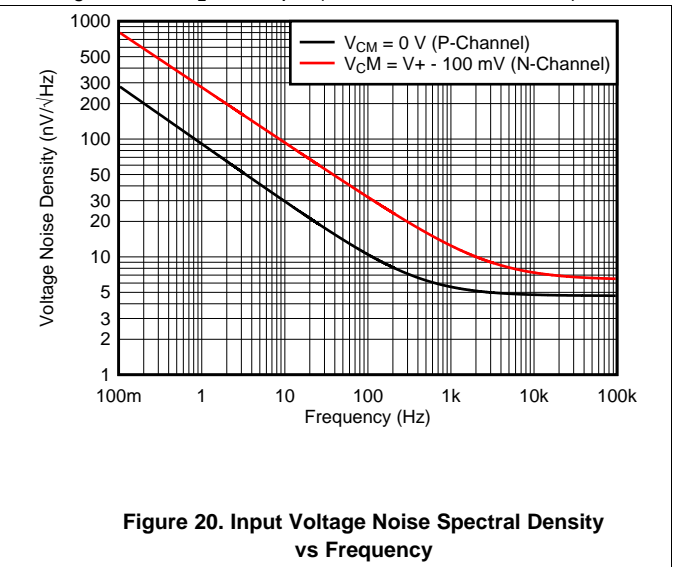
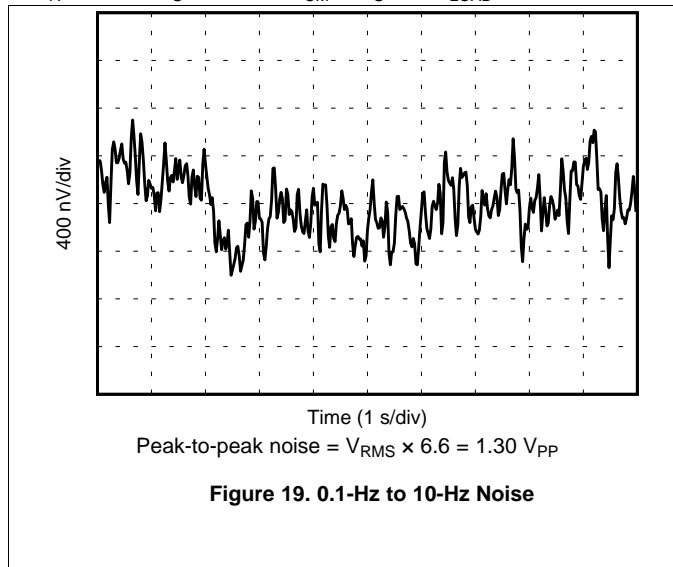

Figure 18. PSRR vs Temperature

at $T_A = 25^\circ\text{C}$, $V_S = \pm 18\text{ V}$, $V_{CM} = V_S / 2$, $R_{LOAD} = 10\text{ k}\Omega$ connected to $V_S / 2$, and $C_L = 100\text{ pF}$ (unless otherwise noted)



OPA197, OPA2197, OPA4197

SBOS737C – JANUARY 2016 – REVISED MARCH 2018

www.ti.com

at $T_A = 25^\circ\text{C}$, $V_S = \pm 18\text{ V}$, $V_{CM} = V_S / 2$, $R_{LOAD} = 10\text{ k}\Omega$ connected to $V_S / 2$, and $C_L = 100\text{ pF}$ (unless otherwise noted)

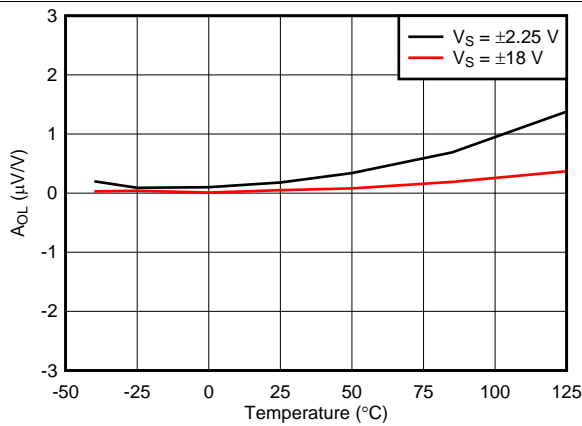

Figure 25. Open-Loop Gain vs Temperature

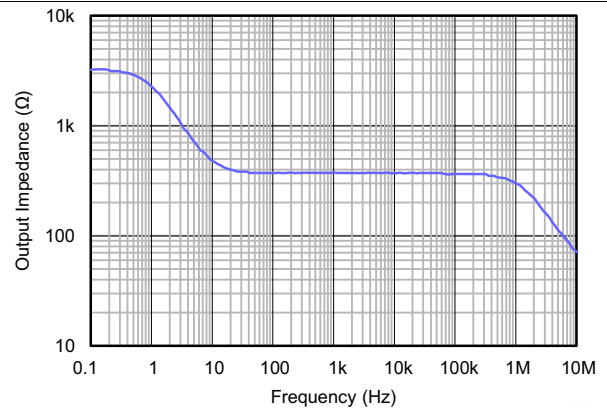
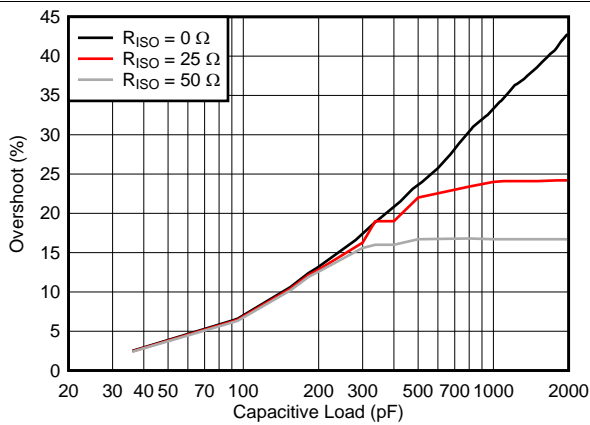
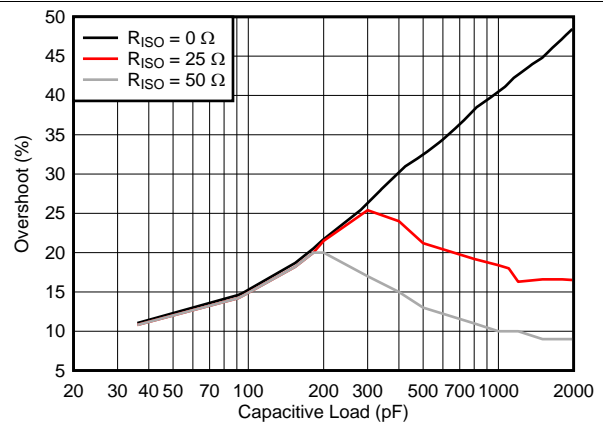

Figure 26. Open-Loop Output Impedance vs Frequency



$G = -1\text{ V/V}$

Figure 27. Small-Signal Overshoot vs Capacitive Load (100-mV Output Step)



$G = 1\text{ V/V}$

Figure 28. Small-Signal Overshoot vs Capacitive Load (100-mV Output Step)

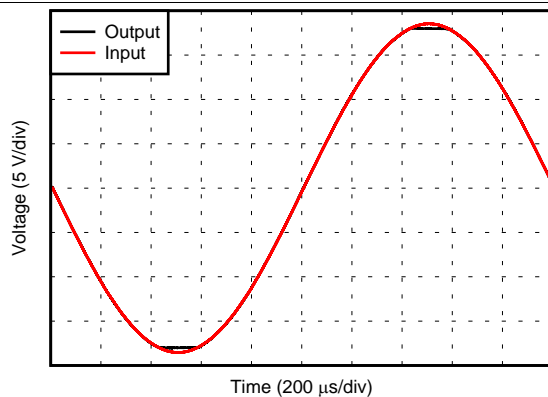

$V_S = \pm 18\text{ V}$, input = $\pm 18.5\text{ V}_{PP}$

Figure 29. No Phase Reversal

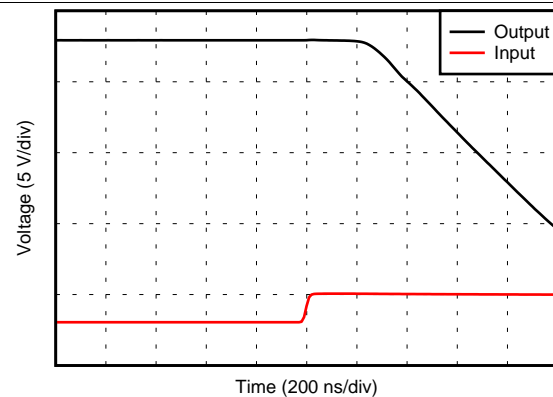

$G = -10\text{ V/V}$

Figure 30. Positive Overload Recovery

at $T_A = 25^\circ\text{C}$, $V_S = \pm 18\text{ V}$, $V_{CM} = V_S / 2$, $R_{LOAD} = 10\text{ k}\Omega$ connected to $V_S / 2$, and $C_L = 100\text{ pF}$ (unless otherwise noted)

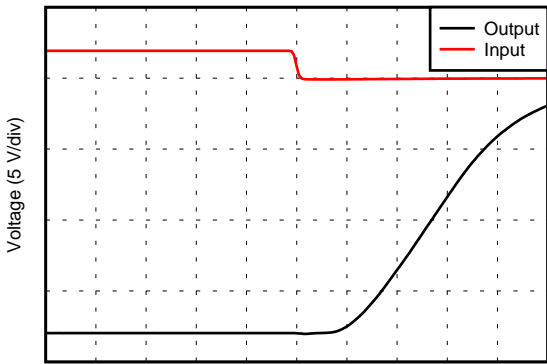

Time (200 ns/div)
G = -10 V/V

Figure 31. Negative Overload Recovery

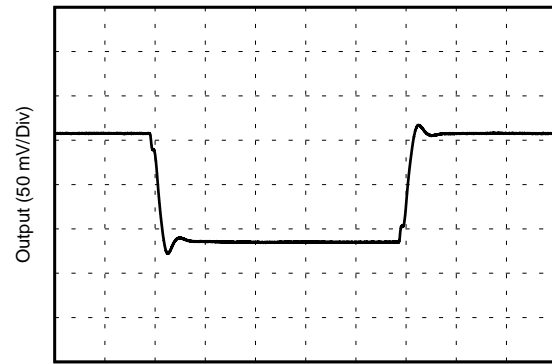

Time (200 ns/Div)
G = 1 V/V

Figure 32. Small-Signal Step Response

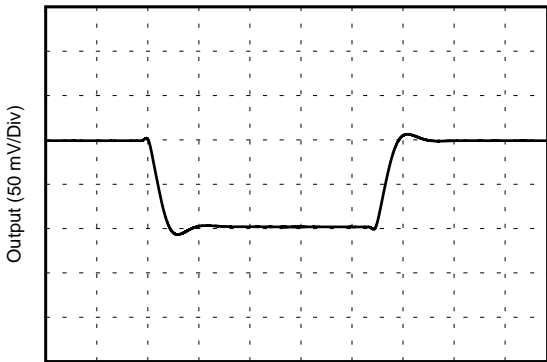

Time (150 ns/Div)
G = -1 V/V

Figure 33. Small-Signal Step Response



Time (300 ns/Div)
G = 1 V/V

Figure 34. Large-Signal Step Response

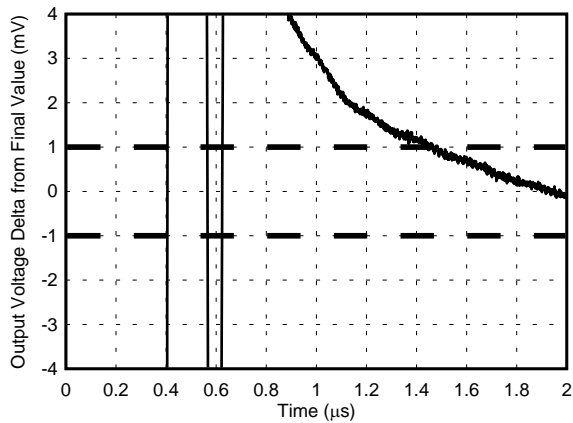

G = 1, 0.01% settling = $\pm 1\text{ mV}$, step applied at $t = 0$

Figure 35. Settling Time (10-V Positive Step)

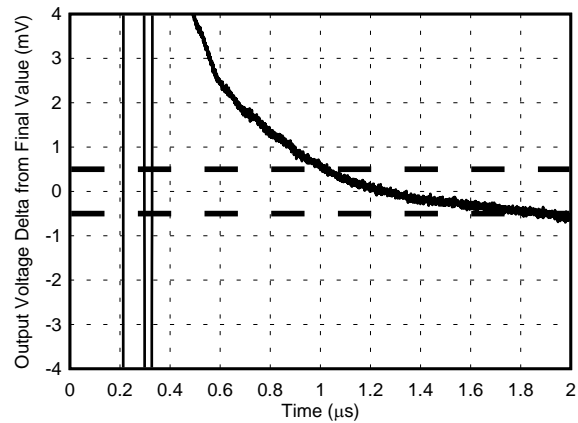

G = 1, 0.01% settling = $\pm 500\text{ }\mu\text{V}$, step applied at $t = 0$

Figure 36. Settling Time (5-V Positive Step)

at $T_A = 25^\circ\text{C}$, $V_S = \pm 18\text{ V}$, $V_{CM} = V_S / 2$, $R_{LOAD} = 10\text{ k}\Omega$ connected to $V_S / 2$, and $C_L = 100\text{ pF}$ (unless otherwise noted)

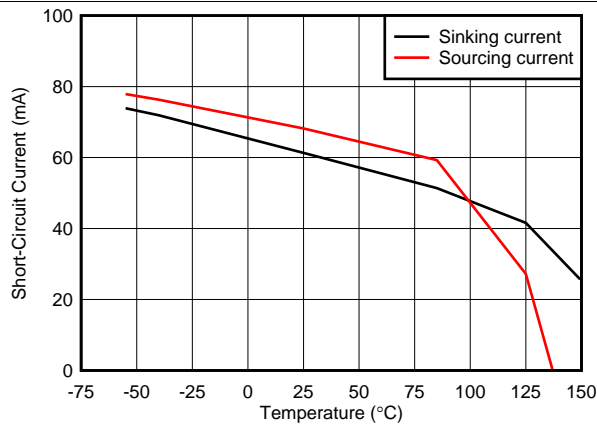

Figure 37. Short-Circuit Current vs Temperature

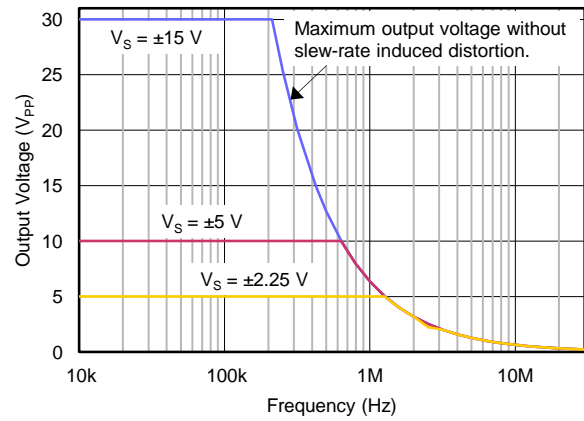

Figure 38. Maximum Output Voltage vs Frequency

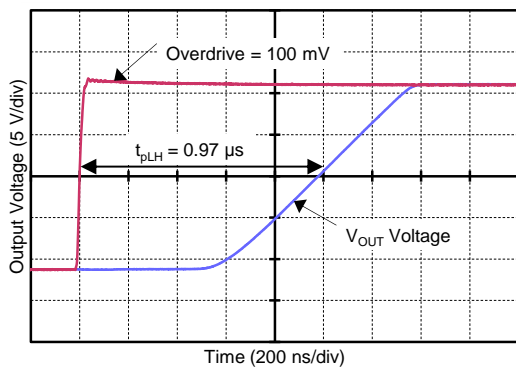

Figure 39. Propagation Delay Rising Edge

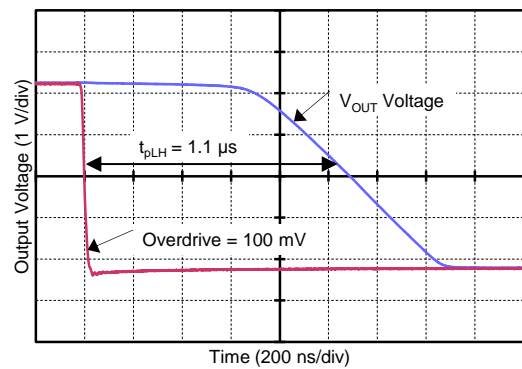

Figure 40. Propagation Delay Falling Edge

7 Detailed Description

7.1 Overview

The OPAx197 uses a patented two-temperature trim architecture to achieve a very low offset voltage of 250 μV (max) and low voltage offset drift of 0.75 $\mu\text{V}/^\circ\text{C}$ (maximum) over the full specified temperature range. This level of precision performance at wide supply voltages makes these amplifiers useful for high-impedance industrial sensors, filters, and high-voltage data acquisition.

7.2 Functional Block Diagram

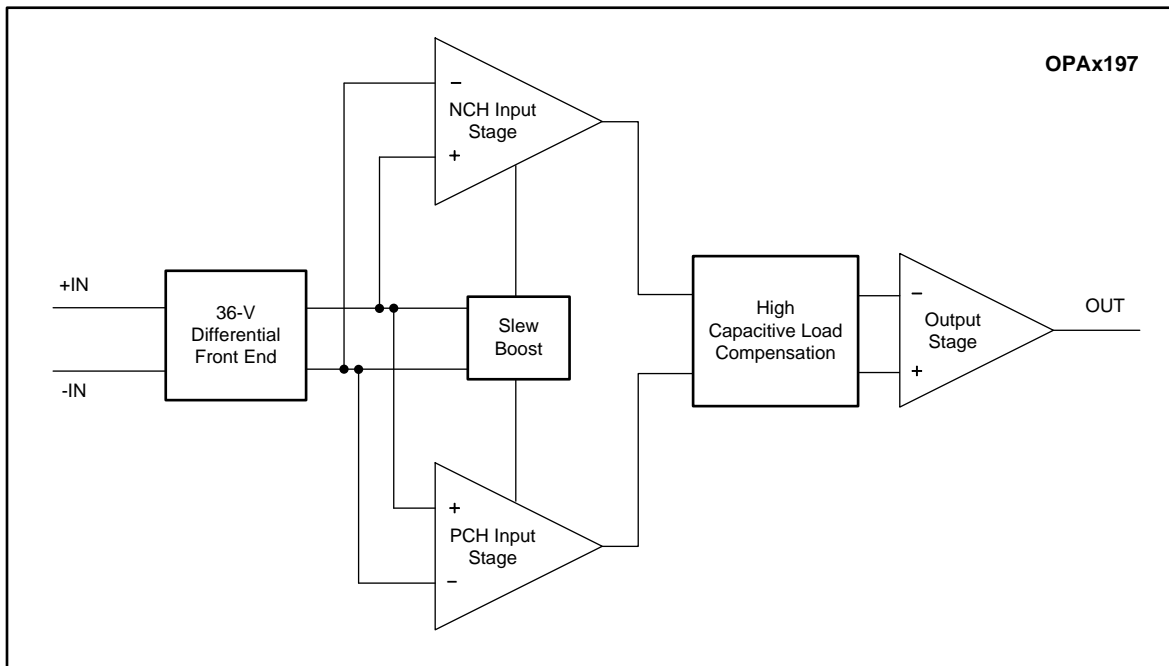

7.3 Feature Description

7.3.1 Input Protection Circuitry

The OPAx197 uses a unique input architecture to eliminate the need for input protection diodes, but still provides robust input protection under transient conditions. Conventional input diode protection schemes shown in Figure 41 can be activated by fast transient step responses and can introduce signal distortion and settling time delays because of alternate current paths, as shown in Figure 42. For low-gain circuits, these fast-ramping input signals forward-bias back-to-back diodes, causing an increase in input current, and resulting in extended settling time, as shown in Figure 43.

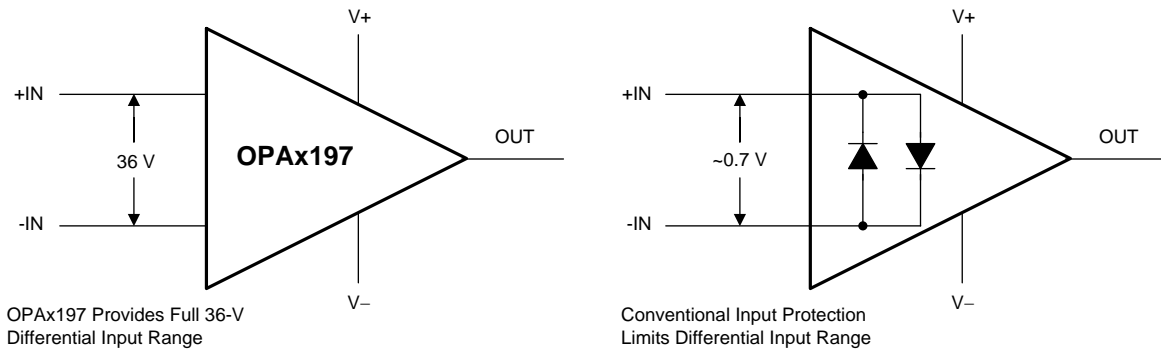

Figure 41. OPA197 Input Protection Does Not Limit Differential Input Capability

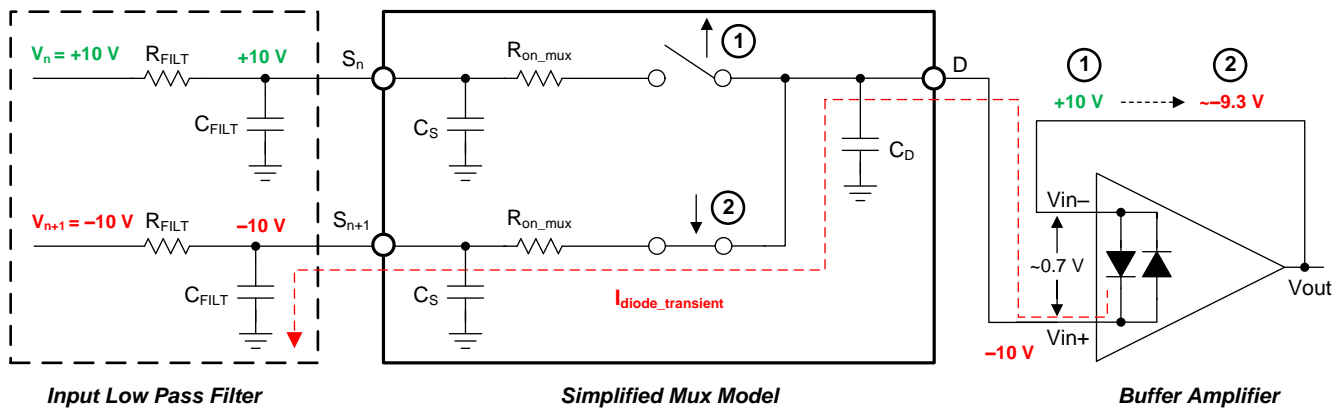

Figure 42. Back-to-Back Diodes Create Settling Issues

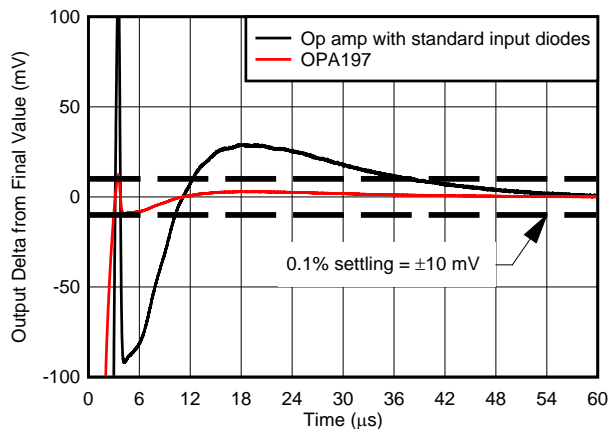

Figure 43. OPA197 Protection Circuit Maintains Fast-Settling Transient Response

Feature Description (continued)

The OPAx197 family of operational amplifiers provides a true high-impedance differential input capability for high-voltage applications. This patented input protection architecture does not introduce additional signal distortion or delayed settling time, making the device an optimal op amp for multichannel, high-switched, input applications. The OPA197 can tolerate a maximum differential swing (voltage between inverting and noninverting pins of the op amp) of up to 36 V, making the device suitable for use as a comparator or in applications with fast-ramping input signals such as multiplexed data-acquisition systems, as shown in [Figure 53](#).

7.3.2 EMI Rejection

The OPAx197 uses integrated electromagnetic interference (EMI) filtering to reduce the effects of EMI from sources such as wireless communications and densely-populated boards with a mix of analog signal chain and digital components. EMI immunity can be improved with circuit design techniques; the OPAx197 benefits from these design improvements. Texas Instruments has developed the ability to accurately measure and quantify the immunity of an operational amplifier over a broad frequency spectrum extending from 10 MHz to 6 GHz. [Figure 44](#) shows the results of this testing on the OPA197. [Table 2](#) shows the EMIRR IN+ values for the OPA197 at particular frequencies commonly encountered in real-world applications. Applications listed in [Table 2](#) may be centered on or operated near the particular frequency shown. Detailed information can also be found in the application report *EMI Rejection Ratio of Operational Amplifiers*, [SBOA128](#), available for download from [www.ti.com](#).

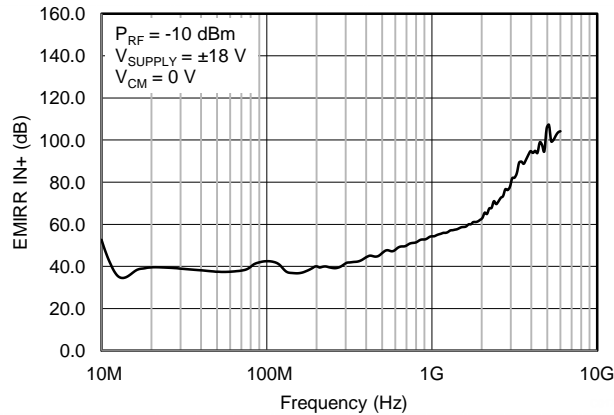

Figure 44. EMIRR Testing

Table 2. OPA197 EMIRR IN+ For Frequencies of Interest

FREQUENCY	APPLICATION OR ALLOCATION	EMIRR IN+
400 MHz	Mobile radio, mobile satellite, space operation, weather, radar, ultra-high frequency (UHF) applications	44.1 dB
900 MHz	Global system for mobile communications (GSM) applications, radio communication, navigation, GPS (to 1.6 GHz), GSM, aeronautical mobile, UHF applications	52.8 dB
1.8 GHz	GSM applications, mobile personal communications, broadband, satellite, L-band (1 GHz to 2 GHz)	61.0 dB
2.4 GHz	802.11b, 802.11g, 802.11n, Bluetooth®, mobile personal communications, industrial, scientific and medical (ISM) radio band, amateur radio and satellite, S-band (2 GHz to 4 GHz)	69.5 dB
3.6 GHz	Radiolocation, aero communication and navigation, satellite, mobile, S-band	88.7 dB
5.0 GHz	802.11a, 802.11n, aero communication and navigation, mobile communication, space and satellite operation, C-band (4 GHz to 8 GHz)	105.5 dB

7.3.3 Phase Reversal Protection

The OPAx197 family has internal phase-reversal protection. Many op amps exhibit a phase reversal when the input is driven beyond its linear common-mode range. This condition is most often encountered in noninverting circuits when the input is driven beyond the specified common-mode voltage range, causing the output to reverse into the opposite rail. The OPAx197 is a rail-to-rail input op amp; therefore, the common-mode range can extend up to the rails. Input signals beyond the rails do not cause phase reversal; instead, the output limits into the appropriate rail. This performance is shown in Figure 45.

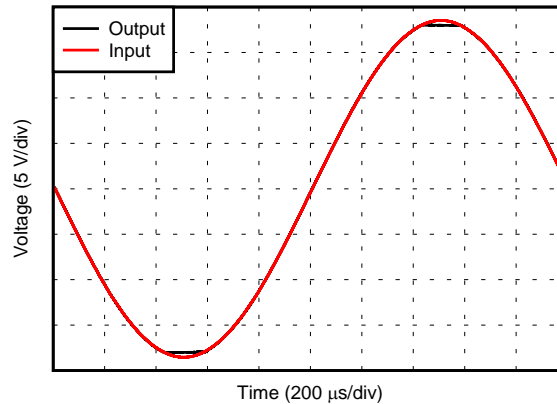

Figure 45. No Phase Reversal

7.3.4 Thermal Protection

The internal power dissipation of any amplifier causes its internal (junction) temperature to rise. This phenomenon is called *self heating*. The absolute maximum junction temperature of the OPAx197 is 150°C. Exceeding this temperature causes damage to the device. The OPAx197 has a thermal protection feature that prevents damage from self heating. The protection works by monitoring the temperature of the device and turning off the op amp output drive for temperatures above 140°C. Figure 46 shows an application example for the OPA197 that has significant self heating (159°C) because of its power dissipation (0.81 W). Thermal calculations indicate that for an ambient temperature of 65°C the device junction temperature must reach 187°C. The actual device, however, turns off the output drive to maintain a safe junction temperature. Figure 46 depicts how the circuit behaves during thermal protection. During normal operation, the device acts as a buffer so the output is 3 V. When self heating causes the device junction temperature to increase above 140°C, the thermal protection forces the output to a high-impedance state and the output is pulled to ground through resistor RL.

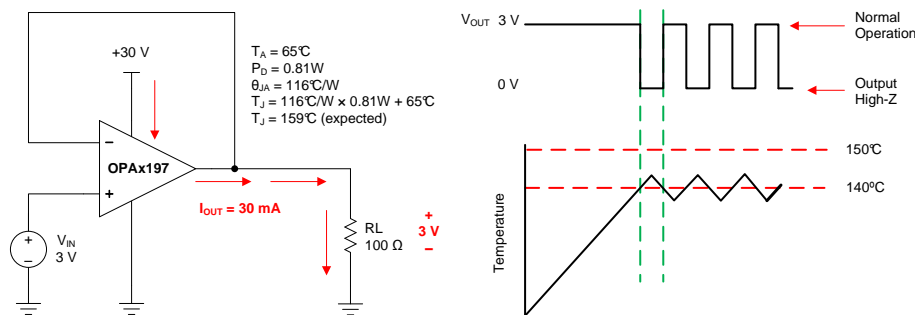

Figure 46. Thermal Protection

7.3.5 Capacitive Load and Stability

The OPAx197 features a patented output stage capable of driving large capacitive loads, and in a unity-gain configuration, directly drives up to 1 nF of pure capacitive load. Increasing the gain enhances the ability of the amplifier to drive greater capacitive loads; see Figure 47 and Figure 48. The particular op amp circuit configuration, layout, gain, and output loading are some of the factors to consider when establishing whether an amplifier will be stable in operation.

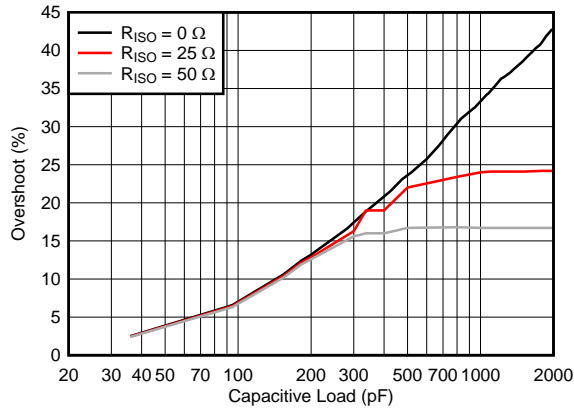

Figure 47. Small-Signal Overshoot vs Capacitive Load (100-mV Output Step, G = -1 V/V)

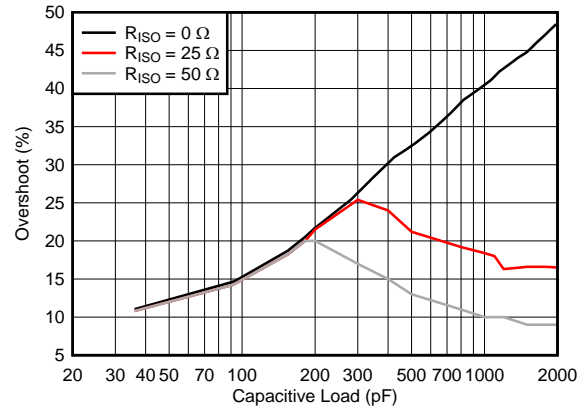

Figure 48. Small-Signal Overshoot vs Capacitive Load (100-mV Output Step, G = 1 V/V)

For additional drive capability in unity-gain configurations, improve capacitive load drive by inserting a small (10-Ω to 20-Ω) resistor, R_{ISO} , in series with the output, as shown in Figure 49. This resistor significantly reduces ringing while maintaining dc performance for purely capacitive loads. However, if there is a resistive load in parallel with the capacitive load, a voltage divider is created, introducing a gain error at the output and slightly reducing the output swing. The error introduced is proportional to the ratio R_{ISO} / R_L , and is generally negligible at low output levels. A high capacitive load drive makes the OPA197 well suited for applications such as reference buffers, MOSFET gate drives, and cable-shield drives. The circuit shown in Figure 49 uses an isolation resistor, R_{ISO} , to stabilize the output of an op amp. R_{ISO} modifies the open-loop gain of the system for increased phase margin, and results using the OPA197 are summarized in Table 3. For additional information on techniques to optimize and design using this circuit, TI Precision Design TIDU032 details complete design goals, simulation, and test results.

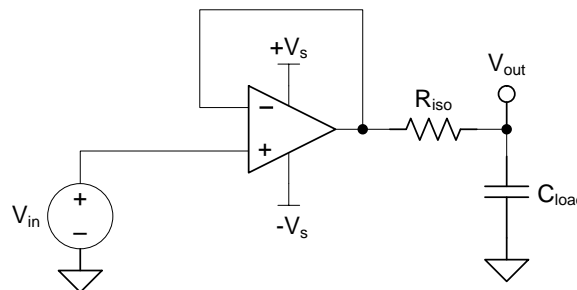

Figure 49. Extending Capacitive Load Drive with the OPA197

Table 3. OPA197 Capacitive Load Drive Solution Using Isolation Resistor Comparison of Calculated and Measured Results

PARAMETER	VALUE									
	100 pF		1000 pF		0.01 μF		0.1 μF		1 μF	
Phase Margin	45°	60°	45°	60°	45°	60°	45°	60°	45°	60°
R_{ISO} (Ω)	47.0	360.0	24.0	100.0	20.0	51.0	6.2	15.8	2.0	4.7
Measured Overshoot (%)	23.2	8.6	10.4	22.5	9.0	22.1	8.7	23.1	8.6	21.0
Calculated PM	45.1°	58.1°	45.8°	59.7°	46.1°	60.1°	45.2°	60.2°	47.2°	60.2°



For step-by-step design procedure, circuit schematics, bill of materials, printed circuit board (PCB) files, simulation results, and test results, refer to TI Precision Design TIDU032, [Capacitive Load Drive Solution using an Isolation Resistor](#).

7.3.6 Common-Mode Voltage Range

The OPAx197 is a 36-V, true rail-to-rail input operational amplifier with an input common-mode range that extends 100 mV beyond either supply rail. This wide range is achieved with paralleled complementary N-channel and P-channel differential input pairs, as shown in Figure 50. The N-channel pair is active for input voltages close to the positive rail, typically $(V+) - 3\text{ V}$ to 100 mV above the positive supply. The P-channel pair is active for inputs from 100 mV below the negative supply to approximately $(V+) - 1.5\text{ V}$. There is a small transition region, typically $(V+) - 3\text{ V}$ to $(V+) - 1.5\text{ V}$ in which both input pairs are on. This transition region can vary modestly with process variation, and within this region PSRR, CMRR, offset voltage, offset drift, noise and THD performance may be degraded compared to operation outside this region.

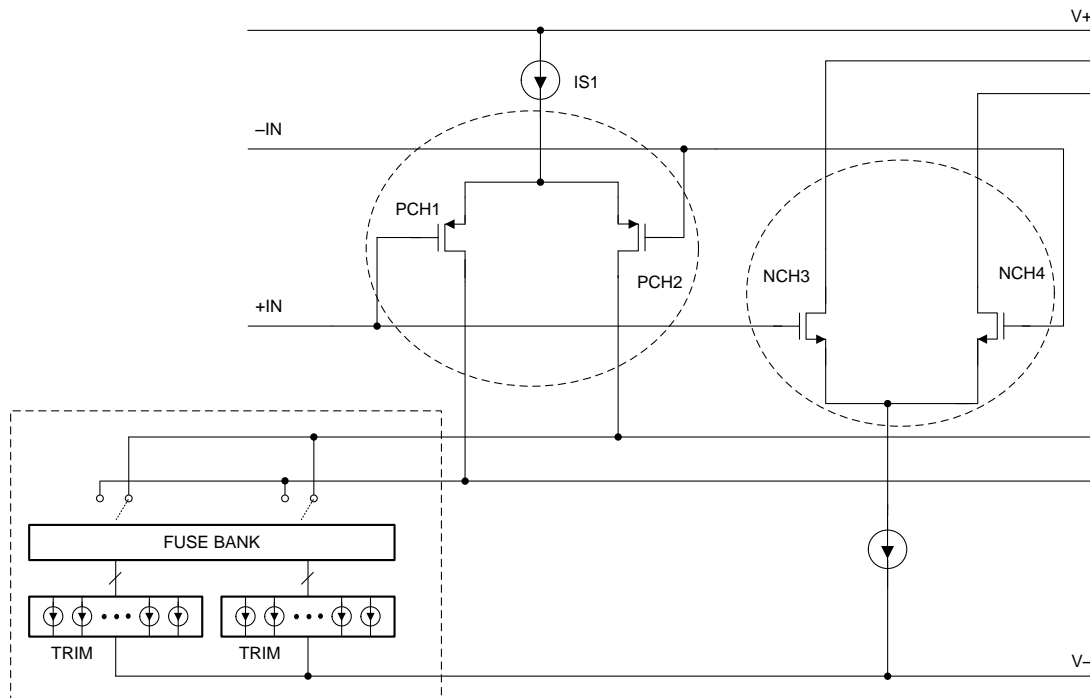

Figure 50. Rail-to-Rail Input Stage

To achieve the best performance for two-stage rail-to-rail input amplifiers, avoid the transition region when possible. The OPAx197 uses a precision trim for both the N-channel and P-channel regions. This technique enables significantly lower levels of offset than previous-generation devices, causing variance in the transition region of the input stages to appear exaggerated relative to offset over the full common-mode voltage range, as shown in Figure 51.

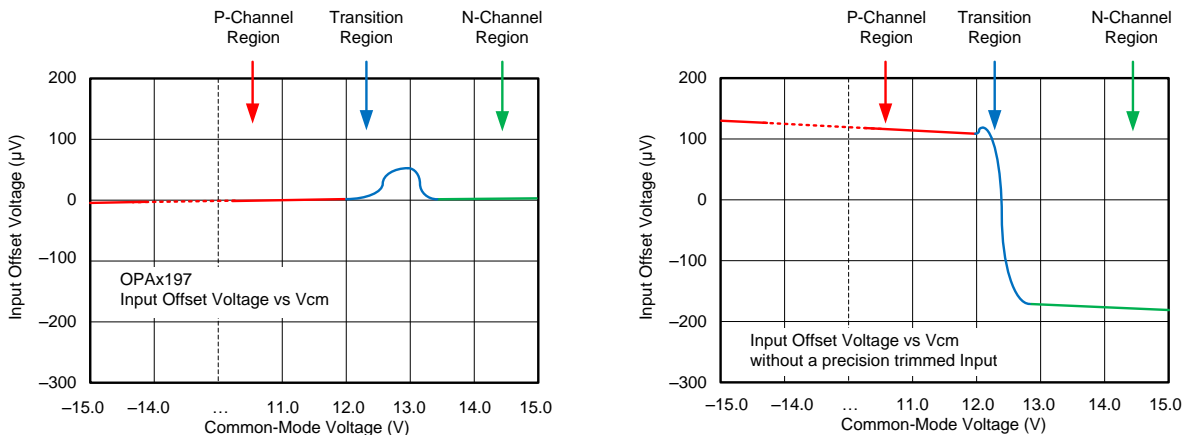

Figure 51. Common-Mode Transition vs Standard Rail-to-Rail Amplifiers

7.3.7 Electrical Overstress

Designers often ask questions about the capability of an operational amplifier to withstand electrical overstress (EOS). These questions tend to focus on the device inputs, but may involve the supply voltage pins or even the output pin. Each of these different pin functions have electrical stress limits determined by the voltage breakdown characteristics of the particular semiconductor fabrication process and specific circuits connected to the pin. Additionally, internal electrostatic discharge (ESD) protection is built into these circuits to protect them from accidental ESD events both before and during product assembly.

Having a good understanding of this basic ESD circuitry and its relevance to an electrical overstress event is helpful. See [Figure 52](#) for an illustration of the ESD circuits contained in the OPAx197 (indicated by the dashed line area). The ESD protection circuitry involves several current-steering diodes connected from the input and output pins and routed back to the internal power-supply lines, where the diodes meet at an absorption device or the power-supply ESD cell, internal to the operational amplifier. This protection circuitry is intended to remain inactive during normal circuit operation.

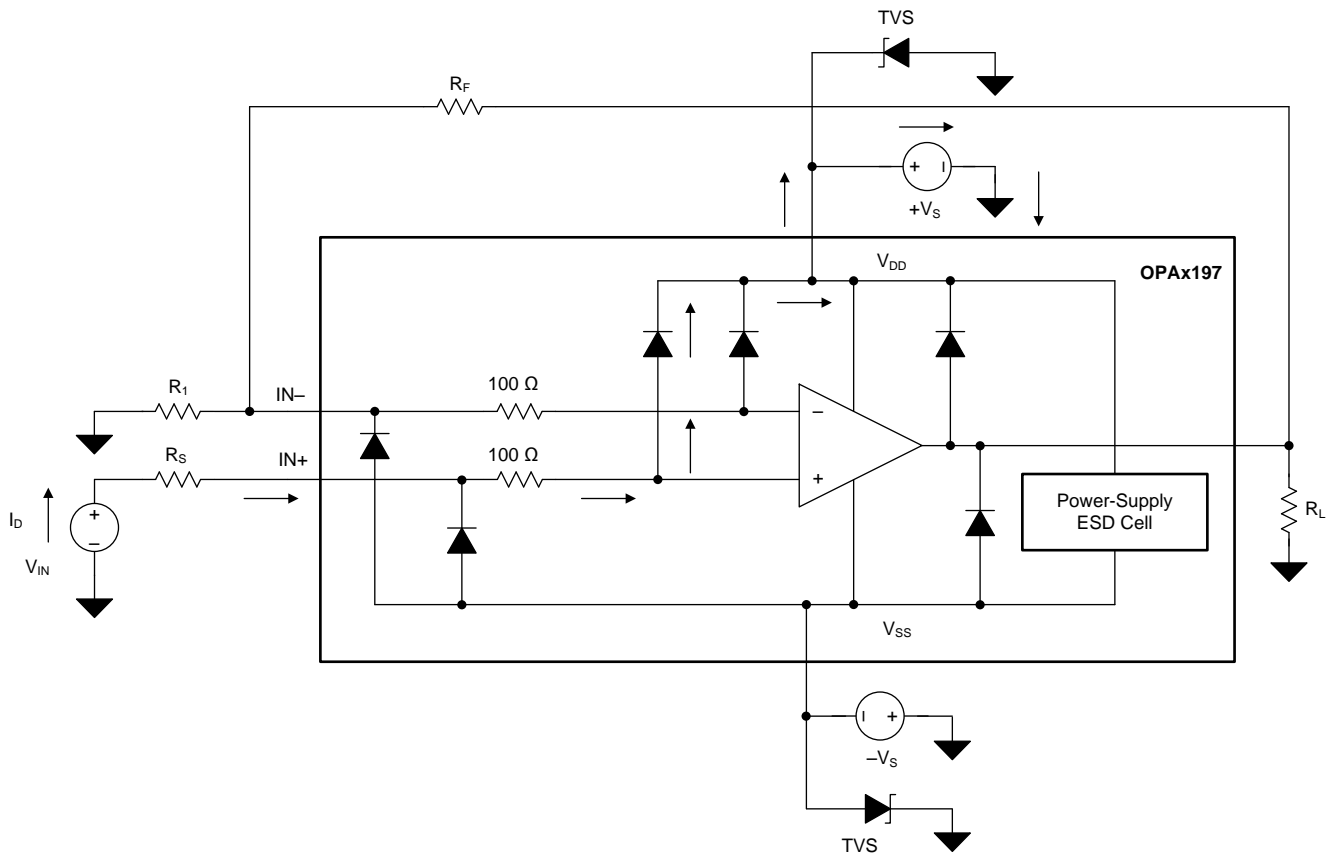

Figure 52. Equivalent Internal ESD Circuitry Relative to a Typical Circuit Application

An ESD event is very short in duration and very high voltage (for example, 1 kV, 100 ns), whereas an EOS event is long duration and lower voltage (for example, 50 V, 100 ms). The ESD diodes are designed for out-of-circuit ESD protection (that is, during assembly, test, and storage of the device before being soldered to the PCB). During an ESD event, the ESD signal is passed through the ESD steering diodes to an absorption circuit (labeled ESD power-supply circuit). The ESD absorption circuit clamps the supplies to a safe level.

Although this behavior is necessary for out-of-circuit protection, excessive current and damage is caused if activated in-circuit. A transient voltage suppressors (TVS) can be used to prevent against damage caused by turning on the ESD absorption circuit during an in-circuit ESD event. Using the appropriate current limiting resistors and TVS diodes allows for the use of device ESD diodes to protect against EOS events.

7.3.8 Overload Recovery

Overload recovery is defined as the time required for the op amp output to recover from a saturated state to a linear state. The output devices of the op amp enter a saturation region when the output voltage exceeds the rated operating voltage, either due to the high input voltage or the high gain. After the device enters the saturation region, the charge carriers in the output devices require time to return back to the linear state. After the charge carriers return back to the linear state, the device begins to slew at the specified slew rate. Thus, the propagation delay in case of an overload condition is the sum of the overload recovery time and the slew time. The overload recovery time for the OPAx197 is approximately 200 ns.

7.4 Device Functional Modes

The OPAx197 has a single functional mode and is operational when the power-supply voltage is greater than 4.5 V (± 2.25 V). The maximum power supply voltage for the OPAx197 is 36 V (± 18 V).

8 Application and Implementation

NOTE

Information in the following applications sections is not part of the TI component specification, and TI does not warrant its accuracy or completeness. TI's customers are responsible for determining suitability of components for their purposes. Customers should validate and test their design implementation to confirm system functionality.

8.1 Application Information

The OPAx197 family offers outstanding dc precision and ac performance. These devices operate up to 36-V supply rails and offer true rail-to-rail input/output, ultralow offset voltage and offset voltage drift, as well as 10-MHz bandwidth and high capacitive load drive. These features make the OPAx197 a robust, high-performance operational amplifier for high-voltage industrial applications.

8.2 Typical Applications

8.2.1 16-Bit Precision Multiplexed Data-Acquisition System

Figure 53 shows a 16-bit, differential, 4-channel, multiplexed data-acquisition system. This example is typical in industrial applications that require low distortion and a high-voltage differential input. The circuit uses the ADS8864, a 16-bit, 400-kSPS successive-approximation-resistor (SAR) analog-to-digital converter (ADC), along with a precision, high-voltage, signal-conditioning front end, and a 4-channel differential multiplexer (mux). This application example explains the process for optimizing the precision, high-voltage, front-end drive circuit using the OPA197 and OPA140 to achieve excellent dynamic performance and linearity with the ADS8864.

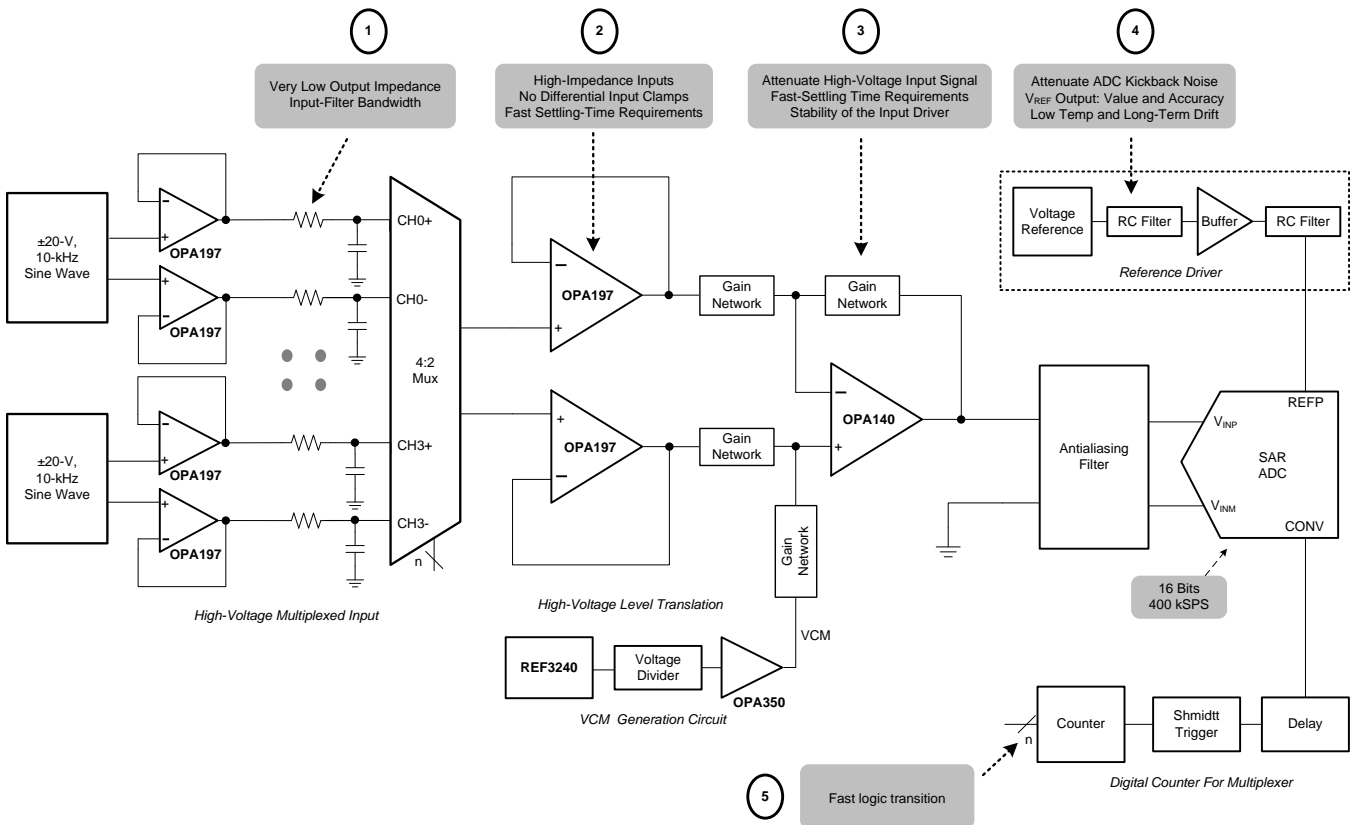

Figure 53. OPA197 in 16-Bit, 400-kSPS, 4-Channel, Multiplexed Data Acquisition System for High-Voltage Inputs With Lowest Distortion

Typical Applications (continued)

8.2.1.1 Design Requirements

The primary objective is to design a ± 20 V, differential 4-channel multiplexed data acquisition system with lowest distortion using the 16-bit ADS8864 at a throughput of 400 kSPS for a 10 kHz full-scale pure sine-wave input. The design requirements for this block design are:

- System Supply Voltage: ± 15 V
- ADC Supply Voltage: 3.3 V
- ADC Sampling Rate: 400 kSPS
- ADC Reference Voltage (REFP): 4.096 V
- System Input Signal: A high-voltage differential input signal with a peak amplitude of 10 V and frequency (f_{IN}) of 10 kHz are applied to each differential input of the mux.

8.2.1.2 Detailed Design Procedure

The purpose of this precision design is to design an optimal high voltage multiplexed data acquisition system for highest system linearity and fast settling. The overall system block diagram is shown in [Figure 53](#). The circuit is a multichannel data acquisition signal chain consisting of an input low-pass filter, multiplexer (mux), mux output buffer, attenuating SAR ADC driver, digital counter for mux and the reference driver. The architecture allows fast sampling of multiple channels using a single ADC, providing a low-cost solution. The two primary design considerations to maximize the performance of a precision multiplexed data acquisition system are the mux input analog front-end and the high-voltage level translation SAR ADC driver design. However, carefully design each analog circuit block based on the ADC performance specifications in order to achieve the fastest settling at 16-bit resolution and lowest distortion system. The diagram includes the most important specifications for each individual analog block.

This design systematically approaches each analog circuit block to achieve a 16-bit settling for a full-scale input stage voltage and linearity for a 10-kHz sinusoidal input signal at each input channel. The first step in the design is to understand the requirement for extremely low impedance input-filter design for the mux. This understanding helps in the decision of an appropriate input filter and selection of a mux to meet the system settling requirements. The next important step is the design of the attenuating analog front end (AFE) used to level translate the high-voltage input signal to a low-voltage ADC input while maintaining the amplifier stability. The next step is to design a digital interface to switch the mux input channels with minimum delay. The final design challenge is to design a high-precision, reference-driver circuit that provides the required REFP reference voltage with low offset, drift, and noise contributions.

8.2.1.3 Application Curve

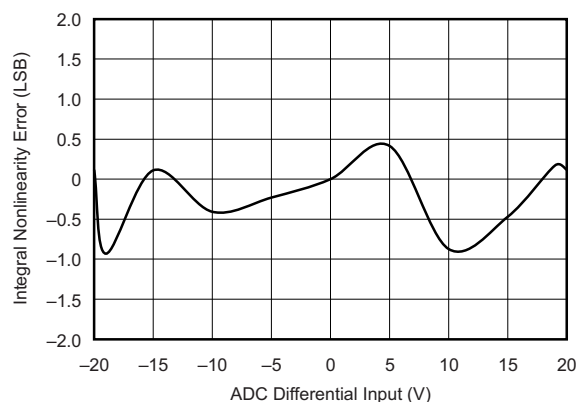

Figure 54. ADC 16-Bit Linearity Error for the Multiplexed Data Acquisition Block



For step-by-step design procedure, circuit schematics, bill of materials, PCB files, simulation results, and test results, refer to [TI Precision Design TIDU181, 16-bit, 400-kSPS, 4-Channel, Multiplexed Data Acquisition System for High Voltage Inputs with Lowest Distortion](#).

8.2.2 Slew Rate Limit for Input Protection

In control systems for valves or motors, abrupt changes in voltages or currents can cause mechanical damages. By controlling the slew rate of the command voltages into the drive circuits, the load voltages ramps up and down at a safe rate. For symmetrical slew-rate applications (positive slew rate equals negative slew rate), one additional op amp provides slew-rate control for a given analog gain stage. The unique input protection and high output current and slew rate of the OPAx197 make the device an optimal amplifier to achieve slew rate control for both dual- and single-supply systems. [Figure 55](#) shows the OPA197 in a slew-rate limit design.

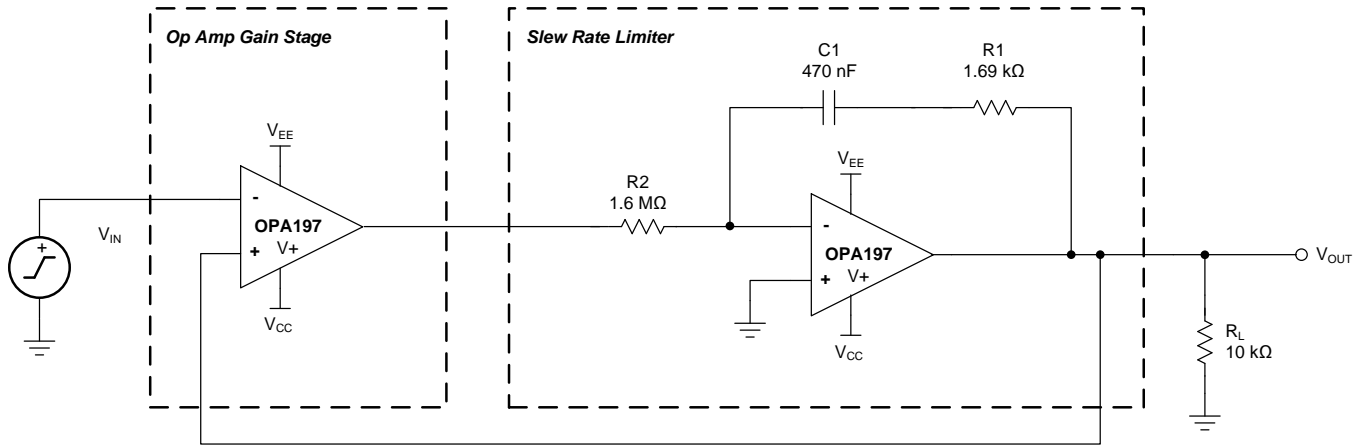

Figure 55. Slew Rate Limiter Uses One Op Amp



For step-by-step design procedure, circuit schematics, bill of materials, PCB files, simulation results, and test results, refer to [TI Precision Design TIDU026, Slew Rate Limiter Uses One Op Amp](#).

8.2.3 Precision Reference Buffer

The OPAx197 features high output current drive capability and low input offset voltage, making the device an excellent reference buffer to provide an accurate buffered output with ample drive current for transients. For the 10- μF ceramic capacitor shown in [Figure 56](#), R_{ISO} , a 37.4- Ω isolation resistor, provides separation of two feedback paths for optimal stability. Feedback path number one is through R_{F} and is directly at the output, V_{OUT} . Feedback path number two is through R_{Fx} and C_{F} and is connected at the output of the op amp. The optimized stability components shown for the 10- μF load give a closed-loop signal bandwidth at V_{OUT} of 4 kHz, while still providing a loop gain phase margin of 89°. Any other load capacitances require recalculation of the stability components: R_{F} , R_{Fx} , C_{F} , and R_{ISO} .

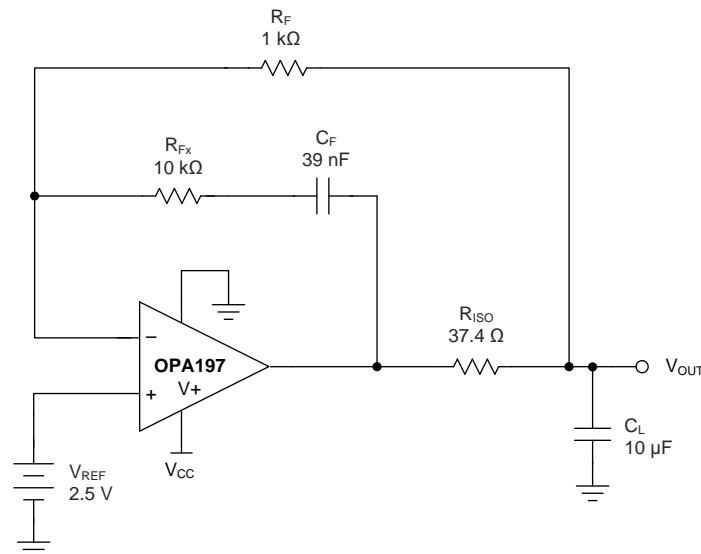

Figure 56. Precision Reference Buffer

9 Power Supply Recommendations

The OPAx197 is specified for operation from 4.5 V to 36 V (± 2.25 V to ± 18 V); many specifications apply from -40°C to $+125^{\circ}\text{C}$. Parameters that can exhibit significant variance with regard to operating voltage or temperature are presented in the [Typical Characteristics](#).

CAUTION

Supply voltages larger than 40 V can permanently damage the device; see the [Absolute Maximum Ratings](#).

Place 0.1- μF bypass capacitors close to the power-supply pins to reduce errors coupling in from noisy or high-impedance power supplies. For more detailed information on bypass capacitor placement, refer to the [Layout](#) section.

10 Layout

10.1 Layout Guidelines

For best operational performance of the device, use good PCB layout practices, including:

- Noise can propagate into analog circuitry through the power pins of the circuit as a whole and op amp itself. Bypass capacitors are used to reduce the coupled noise by providing low-impedance power sources local to the analog circuitry.
 - Connect low-ESR, 0.1- μ F ceramic bypass capacitors between each supply pin and ground, placed as close to the device as possible. A single bypass capacitor from V+ to ground is applicable for single-supply applications.
- Separate grounding for analog and digital portions of circuitry is one of the simplest and most-effective methods of noise suppression. One or more layers on multilayer PCBs are usually devoted to ground planes. A ground plane helps distribute heat and reduces EMI noise pickup. Make sure to physically separate digital and analog grounds paying attention to the flow of the ground current. For more detailed information refer to *Circuit Board Layout Techniques*, [SLOA089](#).
- In order to reduce parasitic coupling, run the input traces as far away from the supply or output traces as possible. If these traces cannot be kept separate, crossing the sensitive trace perpendicular is much better as opposed to in parallel with the noisy trace.
- Place the external components as close to the device as possible. As shown in [Figure 57](#), keeping RF and RG close to the inverting input minimizes parasitic capacitance.
- Keep the length of input traces as short as possible. Always remember that the input traces are the most sensitive part of the circuit.
- Consider a driven, low-impedance guard ring around the critical traces. A guard ring can significantly reduce leakage currents from nearby traces that are at different potentials.
- Cleaning the PCB following board assembly is recommended for best performance.
- Any precision integrated circuit may experience performance shifts due to moisture ingress into the plastic package. Following any aqueous PCB cleaning process, baking the PCB assembly is recommended to remove moisture introduced into the device packaging during the cleaning process. A low temperature, post cleaning bake at 85°C for 30 minutes is sufficient for most circumstances.

10.2 Layout Example

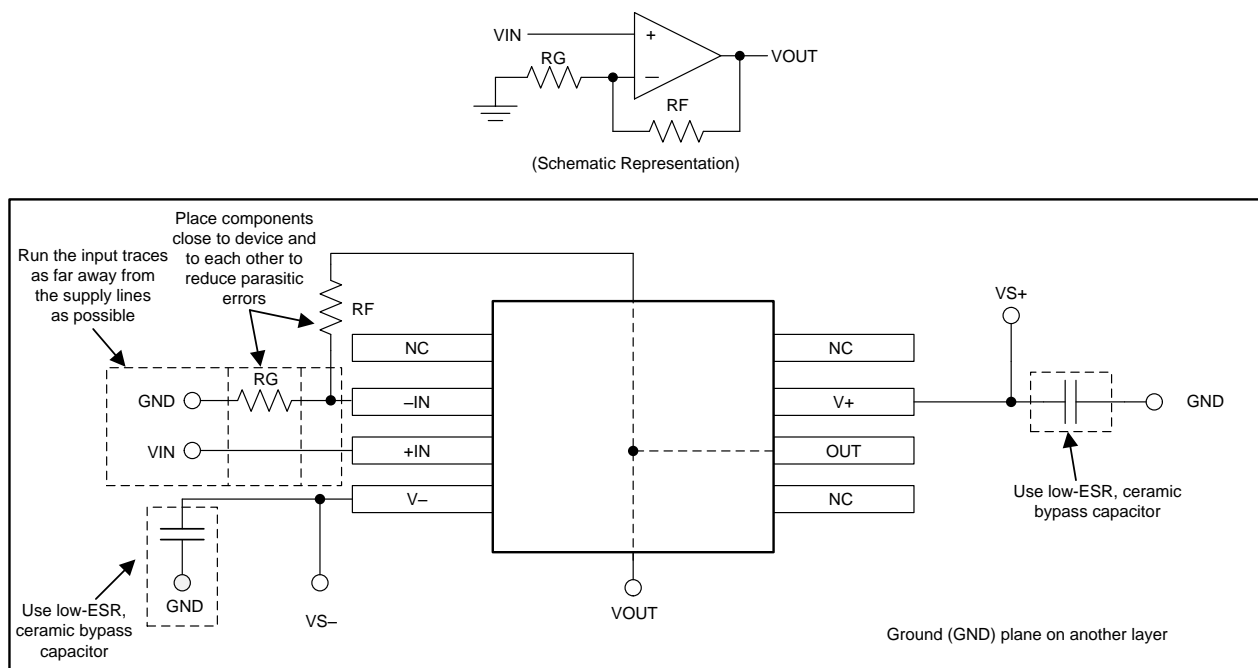

Figure 57. Operational Amplifier Board Layout for Noninverting Configuration

11 Device and Documentation Support

11.1 Device Support

11.1.1 Development Support

11.1.1.1 TINA-TI™ (Free Software Download)

TINA™ is a simple, powerful, and easy-to-use circuit simulation program based on a SPICE engine. TINA-TI is a free, fully-functional version of the TINA software, preloaded with a library of macro models in addition to a range of both passive and active models. TINA-TI provides all the conventional dc, transient, and frequency domain analysis of SPICE, as well as additional design capabilities.

Available as a [free download](#) from the Analog eLab Design Center, TINA-TI offers extensive post-processing capability that allows users to format results in a variety of ways. Virtual instruments offer the ability to select input waveforms and probe circuit nodes, voltages, and waveforms, creating a dynamic quick-start tool.

NOTE

These files require that either the TINA software (from DesignSoft™) or TINA-TI software be installed. Download the free TINA-TI software from the [TINA-TI folder](#).

11.1.1.2 TI Precision Designs

The OPA197 is featured in several TI Precision Designs, available online at the [TI Precision Designs website](#). TI Precision Designs are analog solutions created by TI's precision analog applications experts and offer the theory of operation, component selection, simulation, complete PCB schematic and layout, bill of materials, and measured performance of many useful circuits.

11.2 Documentation Support

11.2.1 Related Documentation

For related documentation see the following:

- [Circuit Board Layout Techniques](#) (SLOA089)
- [Op Amps for Everyone](#) (SLOD006)

11.3 Related Links

[Table 4](#) lists quick access links. Categories include technical documents, support and community resources, tools and software, and quick access to sample or buy.

Table 4. Related Links

PARTS	PRODUCT FOLDER	SAMPLE & BUY	TECHNICAL DOCUMENTS	TOOLS & SOFTWARE	SUPPORT & COMMUNITY
OPA197	Click here	Click here	Click here	Click here	Click here
OPA2197	Click here	Click here	Click here	Click here	Click here
OPA4197	Click here	Click here	Click here	Click here	Click here

11.4 Receiving Notification of Documentation Updates

To receive notification of documentation updates, navigate to the device product folder on ti.com. In the upper right corner, click on *Alert me* to register and receive a weekly digest of any product information that has changed. For change details, review the revision history included in any revised document.

11.5 Community Resources

The following links connect to TI community resources. Linked contents are provided "AS IS" by the respective contributors. They do not constitute TI specifications and do not necessarily reflect TI's views; see TI's [Terms of Use](#).

TI E2E™ Online Community *TI's Engineer-to-Engineer (E2E) Community*. Created to foster collaboration among engineers. At e2e.ti.com, you can ask questions, share knowledge, explore ideas and help solve problems with fellow engineers.

Design Support *TI's Design Support* Quickly find helpful E2E forums along with design support tools and contact information for technical support.

11.6 Trademarks

E2E is a trademark of Texas Instruments.

TINA-TI is a trademark of Texas Instruments, Inc and DesignSoft, Inc.

Bluetooth is a registered trademark of Bluetooth SIG, Inc.

TINA, DesignSoft are trademarks of DesignSoft, Inc.

All other trademarks are the property of their respective owners.

11.7 Electrostatic Discharge Caution



This integrated circuit can be damaged by ESD. Texas Instruments recommends that all integrated circuits be handled with appropriate precautions. Failure to observe proper handling and installation procedures can cause damage.

ESD damage can range from subtle performance degradation to complete device failure. Precision integrated circuits may be more susceptible to damage because very small parametric changes could cause the device not to meet its published specifications.

11.8 Glossary

[SLYZ022](#) — *TI Glossary*.

This glossary lists and explains terms, acronyms, and definitions.

12 Mechanical, Packaging, and Orderable Information

The following pages include mechanical packaging and orderable information. This information is the most current data available for the designated devices. This data is subject to change without notice and revision of this document. For browser-based versions of this data sheet, refer to the left-hand navigation.

PACKAGING INFORMATION

Orderable Device	Status (1)	Package Type	Package Drawing	Pins	Package Qty	Eco Plan (2)	Lead finish/ Ball material (6)	MSL Peak Temp (3)	Op Temp (°C)	Device Marking (4/5)	Samples
OPA197ID	ACTIVE	SOIC	D	8	75	RoHS & Green	NIPDAU	Level-2-260C-1 YEAR	-40 to 125	OPA197	Samples
OPA197IDBVR	ACTIVE	SOT-23	DBV	5	3000	RoHS & Green	NIPDAU	Level-2-260C-1 YEAR	-40 to 125	12MV	Samples
OPA197IDBVT	ACTIVE	SOT-23	DBV	5	250	RoHS & Green	NIPDAU	Level-2-260C-1 YEAR	-40 to 125	12MV	Samples
OPA197IDGKR	ACTIVE	VSSOP	DGK	8	2500	RoHS & Green	NIPDAU	Level-2-260C-1 YEAR	-40 to 125	12ST	Samples
OPA197IDGKT	ACTIVE	VSSOP	DGK	8	250	RoHS & Green	NIPDAU	Level-2-260C-1 YEAR	-40 to 125	12ST	Samples
OPA197IDR	ACTIVE	SOIC	D	8	2500	RoHS & Green	NIPDAU	Level-2-260C-1 YEAR	-40 to 125	OPA197	Samples
OPA2197ID	ACTIVE	SOIC	D	8	75	RoHS & Green	NIPDAU	Level-2-260C-1 YEAR	-40 to 125	2197	Samples
OPA2197IDGKR	ACTIVE	VSSOP	DGK	8	2500	RoHS & Green	NIPDAU	Level-2-260C-1 YEAR	-40 to 125	4HV	Samples
OPA2197IDGKT	ACTIVE	VSSOP	DGK	8	250	RoHS & Green	NIPDAU	Level-2-260C-1 YEAR	-40 to 125	4HV	Samples
OPA2197IDR	ACTIVE	SOIC	D	8	2500	RoHS & Green	NIPDAU	Level-2-260C-1 YEAR	-40 to 125	2197	Samples
OPA4197ID	ACTIVE	SOIC	D	14	50	RoHS & Green	NIPDAU	Level-3-260C-168 HR	-40 to 125	OPA4197	Samples
OPA4197IDR	ACTIVE	SOIC	D	14	2500	RoHS & Green	NIPDAU	Level-3-260C-168 HR	-40 to 125	OPA4197	Samples
OPA4197IPW	ACTIVE	TSSOP	PW	14	90	RoHS & Green	SN	Level-3-260C-168 HR	-40 to 125	OPA4197	Samples
OPA4197IPWR	ACTIVE	TSSOP	PW	14	2000	RoHS & Green	SN	Level-3-260C-168 HR	-40 to 125	OPA4197	Samples

(1) The marketing status values are defined as follows:

ACTIVE: Product device recommended for new designs.

LIFEBUY: TI has announced that the device will be discontinued, and a lifetime-buy period is in effect.

NRND: Not recommended for new designs. Device is in production to support existing customers, but TI does not recommend using this part in a new design.

PREVIEW: Device has been announced but is not in production. Samples may or may not be available.

OBsolete: TI has discontinued the production of the device.

(2) **RoHS:** TI defines "RoHS" to mean semiconductor products that are compliant with the current EU RoHS requirements for all 10 RoHS substances, including the requirement that RoHS substance do not exceed 0.1% by weight in homogeneous materials. Where designed to be soldered at high temperatures, "RoHS" products are suitable for use in specified lead-free processes. TI may reference these types of products as "Pb-Free".

RoHS Exempt: TI defines "RoHS Exempt" to mean products that contain lead but are compliant with EU RoHS pursuant to a specific EU RoHS exemption.

Green: TI defines "Green" to mean the content of Chlorine (Cl) and Bromine (Br) based flame retardants meet JS709B low halogen requirements of <=1000ppm threshold. Antimony trioxide based flame retardants must also meet the <=1000ppm threshold requirement.

(3) MSL, Peak Temp. - The Moisture Sensitivity Level rating according to the JEDEC industry standard classifications, and peak solder temperature.

(4) There may be additional marking, which relates to the logo, the lot trace code information, or the environmental category on the device.

(5) Multiple Device Markings will be inside parentheses. Only one Device Marking contained in parentheses and separated by a "~" will appear on a device. If a line is indented then it is a continuation of the previous line and the two combined represent the entire Device Marking for that device.

(6) Lead finish/Ball material - Orderable Devices may have multiple material finish options. Finish options are separated by a vertical ruled line. Lead finish/Ball material values may wrap to two lines if the finish value exceeds the maximum column width.

Important Information and Disclaimer: The information provided on this page represents TI's knowledge and belief as of the date that it is provided. TI bases its knowledge and belief on information provided by third parties, and makes no representation or warranty as to the accuracy of such information. Efforts are underway to better integrate information from third parties. TI has taken and continues to take reasonable steps to provide representative and accurate information but may not have conducted destructive testing or chemical analysis on incoming materials and chemicals. TI and TI suppliers consider certain information to be proprietary, and thus CAS numbers and other limited information may not be available for release.

In no event shall TI's liability arising out of such information exceed the total purchase price of the TI part(s) at issue in this document sold by TI to Customer on an annual basis.

OTHER QUALIFIED VERSIONS OF OPA197, OPA2197 :

- Automotive: [OPA197-Q1](#), [OPA2197-Q1](#)

NOTE: Qualified Version Definitions:

- Automotive - Q100 devices qualified for high-reliability automotive applications targeting zero defects

TAPE AND REEL INFORMATION

QUADRANT ASSIGNMENTS FOR PIN 1 ORIENTATION IN TAPE

*All dimensions are nominal

Device	Package Type	Package Drawing	Pins	SPQ	Reel Diameter (mm)	Reel Width W1 (mm)	A0 (mm)	B0 (mm)	K0 (mm)	P1 (mm)	W (mm)	Pin1 Quadrant
OPA197IDBVR	SOT-23	DBV	5	3000	180.0	8.4	3.23	3.17	1.37	4.0	8.0	Q3
OPA197IDBVT	SOT-23	DBV	5	250	180.0	8.4	3.23	3.17	1.37	4.0	8.0	Q3
OPA197IDGKR	VSSOP	DGK	8	2500	330.0	12.4	5.3	3.4	1.4	8.0	12.0	Q1
OPA197IDGKT	VSSOP	DGK	8	250	177.8	12.4	5.3	3.4	1.4	8.0	12.0	Q1
OPA197IDR	SOIC	D	8	2500	330.0	12.4	6.4	5.2	2.1	8.0	12.0	Q1
OPA2197IDGKR	VSSOP	DGK	8	2500	330.0	12.4	5.3	3.4	1.4	8.0	12.0	Q1
OPA2197IDGKT	VSSOP	DGK	8	250	177.8	12.4	5.3	3.4	1.4	8.0	12.0	Q1
OPA2197IDR	SOIC	D	8	2500	330.0	12.4	6.4	5.2	2.1	8.0	12.0	Q1
OPA4197IDR	SOIC	D	14	2500	330.0	16.4	6.5	9.0	2.1	8.0	16.0	Q1
OPA4197IPWR	TSSOP	PW	14	2000	330.0	12.4	6.9	5.6	1.6	8.0	12.0	Q1

TAPE AND REEL BOX DIMENSIONS

*All dimensions are nominal

Device	Package Type	Package Drawing	Pins	SPQ	Length (mm)	Width (mm)	Height (mm)
OPA197IDBVR	SOT-23	DBV	5	3000	223.0	270.0	35.0
OPA197IDBVT	SOT-23	DBV	5	250	223.0	270.0	35.0
OPA197IDGKR	VSSOP	DGK	8	2500	346.0	346.0	29.0
OPA197IDGKT	VSSOP	DGK	8	250	223.0	270.0	35.0
OPA197IDR	SOIC	D	8	2500	356.0	356.0	35.0
OPA2197IDGKR	VSSOP	DGK	8	2500	346.0	346.0	29.0
OPA2197IDGKT	VSSOP	DGK	8	250	223.0	270.0	35.0
OPA2197IDR	SOIC	D	8	2500	356.0	356.0	35.0
OPA4197IDR	SOIC	D	14	2500	356.0	356.0	35.0
OPA4197IPWR	TSSOP	PW	14	2000	356.0	356.0	35.0

TUBE

*All dimensions are nominal

Device	Package Name	Package Type	Pins	SPQ	L (mm)	W (mm)	T (μm)	B (mm)
OPA197ID	D	SOIC	8	75	506.6	8	3940	4.32
OPA2197ID	D	SOIC	8	75	506.6	8	3940	4.32
OPA4197ID	D	SOIC	14	50	506.6	8	3940	4.32
OPA4197IPW	PW	TSSOP	14	90	508	8.5	3250	2.8

EXAMPLE BOARD LAYOUT

DBV0005A

SOT-23 - 1.45 mm max height

SMALL OUTLINE TRANSISTOR



LAND PATTERN EXAMPLE
EXPOSED METAL SHOWN
SCALE:15X

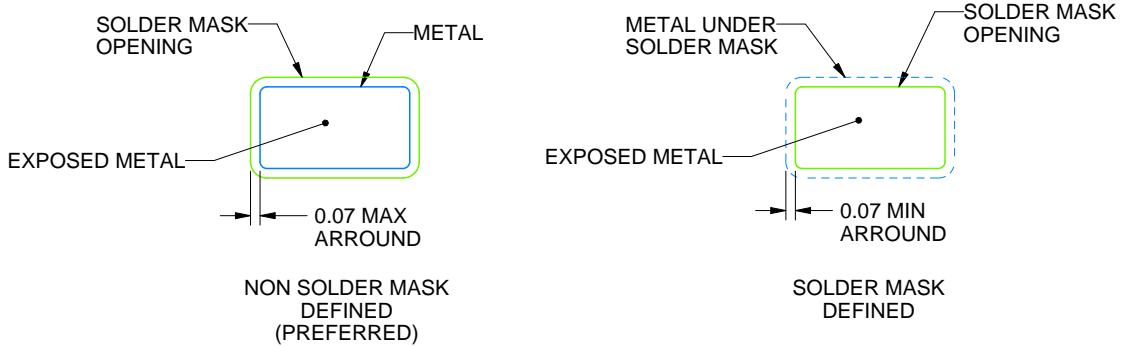

SOLDER MASK DETAILS

4214839/F 06/2021

NOTES: (continued)

- 5. Publication IPC-7351 may have alternate designs.
- 6. Solder mask tolerances between and around signal pads can vary based on board fabrication site.

EXAMPLE STENCIL DESIGN

DBV0005A

SOT-23 - 1.45 mm max height

SMALL OUTLINE TRANSISTOR



SOLDER PASTE EXAMPLE
BASED ON 0.125 mm THICK STENCIL
SCALE:15X

4214839/F 06/2021

NOTES: (continued)

7. Laser cutting apertures with trapezoidal walls and rounded corners may offer better paste release. IPC-7525 may have alternate design recommendations.
8. Board assembly site may have different recommendations for stencil design.

D (R-PDSO-G14)

PLASTIC SMALL OUTLINE



- NOTES:
- A. All linear dimensions are in inches (millimeters).
 - B. This drawing is subject to change without notice.
 - $\triangle C$ Body length does not include mold flash, protrusions, or gate burrs. Mold flash, protrusions, or gate burrs shall not exceed 0.006 (0,15) each side.
 - $\triangle D$ Body width does not include interlead flash. Interlead flash shall not exceed 0.017 (0,43) each side.
 - E. Reference JEDEC MS-012 variation AB.

D (R-PDSO-G14)

PLASTIC SMALL OUTLINE



4211283-3/E 08/12

- NOTES:
- All linear dimensions are in millimeters.
 - This drawing is subject to change without notice.
 - Publication IPC-7351 is recommended for alternate designs.
 - Laser cutting apertures with trapezoidal walls and also rounding corners will offer better paste release. Customers should contact their board assembly site for stencil design recommendations. Refer to IPC-7525 for other stencil recommendations.
 - Customers should contact their board fabrication site for solder mask tolerances between and around signal pads.

PW (R-PDSO-G14)

PLASTIC SMALL OUTLINE



- NOTES:
- A. All linear dimensions are in millimeters. Dimensioning and tolerancing per ASME Y14.5M-1994.
 - B. This drawing is subject to change without notice.
 - C. Body length does not include mold flash, protrusions, or gate burrs. Mold flash, protrusions, or gate burrs shall not exceed 0,15 each side.
 - D. Body width does not include interlead flash. Interlead flash shall not exceed 0,25 each side.
 - E. Falls within JEDEC MO-153



D0008A

PACKAGE OUTLINE

SOIC - 1.75 mm max height

SMALL OUTLINE INTEGRATED CIRCUIT



4214825/C 02/2019

NOTES:

1. Linear dimensions are in inches [millimeters]. Dimensions in parenthesis are for reference only. Controlling dimensions are in inches. Dimensioning and tolerancing per ASME Y14.5M.
2. This drawing is subject to change without notice.
3. This dimension does not include mold flash, protrusions, or gate burrs. Mold flash, protrusions, or gate burrs shall not exceed $.006$ [0.15] per side.
4. This dimension does not include interlead flash.
5. Reference JEDEC registration MS-012, variation AA.

EXAMPLE BOARD LAYOUT

D0008A

SOIC - 1.75 mm max height

SMALL OUTLINE INTEGRATED CIRCUIT



LAND PATTERN EXAMPLE
EXPOSED METAL SHOWN
SCALE:8X



SOLDER MASK DETAILS

4214825/C 02/2019

NOTES: (continued)

6. Publication IPC-7351 may have alternate designs.

7. Solder mask tolerances between and around signal pads can vary based on board fabrication site.

EXAMPLE STENCIL DESIGN

D0008A

SOIC - 1.75 mm max height

SMALL OUTLINE INTEGRATED CIRCUIT



SOLDER PASTE EXAMPLE
BASED ON .005 INCH [0.125 MM] THICK STENCIL
SCALE:8X

4214825/C 02/2019

NOTES: (continued)

8. Laser cutting apertures with trapezoidal walls and rounded corners may offer better paste release. IPC-7525 may have alternate design recommendations.
9. Board assembly site may have different recommendations for stencil design.

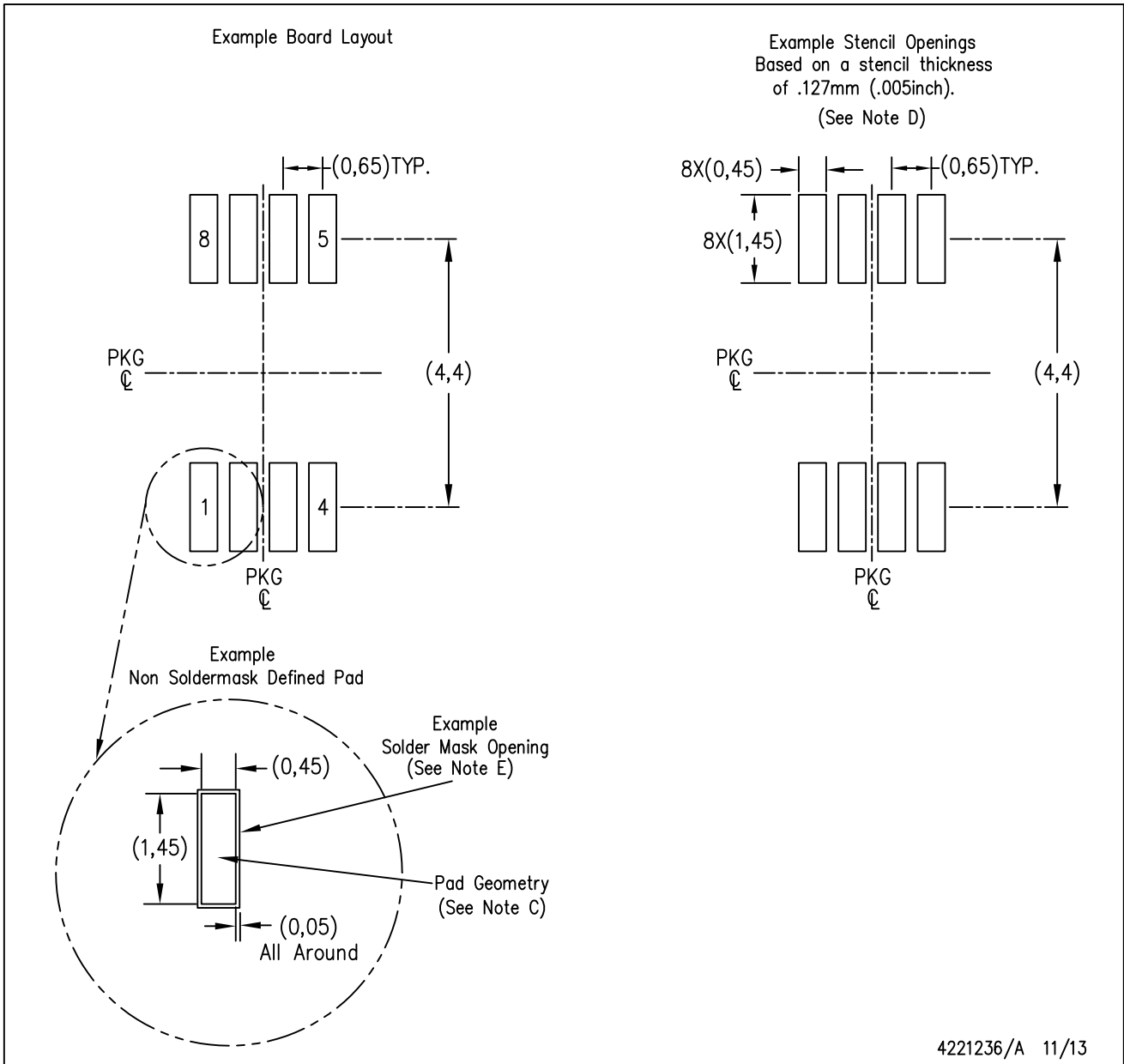

- NOTES:
- A. All linear dimensions are in millimeters.
 - B. This drawing is subject to change without notice.
 - C. Publication IPC-7351 is recommended for alternate designs.
 - D. Laser cutting apertures with trapezoidal walls and also rounding corners will offer better paste release. Customers should contact their board assembly site for stencil design recommendations. Refer to IPC-7525 for other stencil recommendations.
 - E. Customers should contact their board fabrication site for solder mask tolerances between and around signal pads.

IMPORTANT NOTICE AND DISCLAIMER

TI PROVIDES TECHNICAL AND RELIABILITY DATA (INCLUDING DATA SHEETS), DESIGN RESOURCES (INCLUDING REFERENCE DESIGNS), APPLICATION OR OTHER DESIGN ADVICE, WEB TOOLS, SAFETY INFORMATION, AND OTHER RESOURCES "AS IS" AND WITH ALL FAULTS, AND DISCLAIMS ALL WARRANTIES, EXPRESS AND IMPLIED, INCLUDING WITHOUT LIMITATION ANY IMPLIED WARRANTIES OF MERCHANTABILITY, FITNESS FOR A PARTICULAR PURPOSE OR NON-INFRINGEMENT OF THIRD PARTY INTELLECTUAL PROPERTY RIGHTS.

These resources are intended for skilled developers designing with TI products. You are solely responsible for (1) selecting the appropriate TI products for your application, (2) designing, validating and testing your application, and (3) ensuring your application meets applicable standards, and any other safety, security, regulatory or other requirements.

These resources are subject to change without notice. TI grants you permission to use these resources only for development of an application that uses the TI products described in the resource. Other reproduction and display of these resources is prohibited. No license is granted to any other TI intellectual property right or to any third party intellectual property right. TI disclaims responsibility for, and you will fully indemnify TI and its representatives against, any claims, damages, costs, losses, and liabilities arising out of your use of these resources.

TI's products are provided subject to [TI's Terms of Sale](#) or other applicable terms available either on ti.com or provided in conjunction with such TI products. TI's provision of these resources does not expand or otherwise alter TI's applicable warranties or warranty disclaimers for TI products.

TI objects to and rejects any additional or different terms you may have proposed.

Mailing Address: Texas Instruments, Post Office Box 655303, Dallas, Texas 75265
Copyright © 2022, Texas Instruments Incorporated

单击下面可查看定价，库存，交付和生命周期等信息

[>>TI\(德州仪器\)](#)