

TPDxE05U06-Q1 1 and 4 Channel ESD Protection Diodes for SuperSpeed (Up to 6 Gbps) Interface

1 Features

- AEC-Q101 Qualified
 - Device HBM Classification Level H3B
 - Device CDM Classification Level C5
 - Device Temperature Range: -40°C to $+125^{\circ}\text{C}$
- IEC 61000-4-2 Level 4 ESD Protection (See the [ESD Ratings—IEC Specification Table](#))
 - $\pm 12\text{-kV}$ Contact Discharge
 - $\pm 15\text{-kV}$ Air Gap Discharge
- IEC 61000-4-4 EFT Protection
 - 80 A (5/50 ns)
- IEC 61000-4-5 Surge Protection
 - 2.5 A (8/20 μs)
- I/O Capacitance 0.42 pF to 0.5 pF (Typical)
- DC Breakdown Voltage 6.4 V (Minimum)
- Ultra Low Leakage Current 10 nA (Maximum)
- Low ESD Clamping Voltage (14 V at 5-A TLP)
- Easy Flow-Through Routing Packages

2 Applications

- End Equipment
 - Head Unit
 - Rear Seat Entertainment
 - Telematics
 - USB Hub
 - Navigation Module
 - Media Interface

TPD4E05U06-Q1 Simplified Schematic

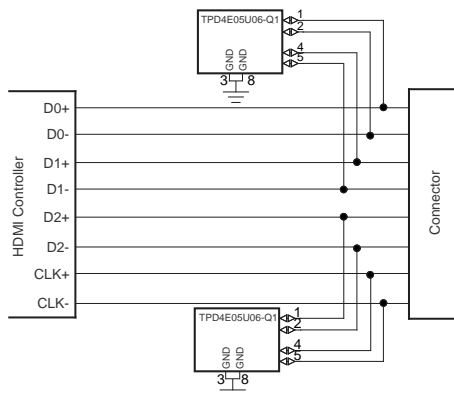

Copyright © 2016, Texas Instruments Incorporated

- Interfaces
 - USB 2.0
 - USB 3.0
 - HDMI 1.4/2.0
 - LVDS
 - DisplayPort
 - SIM Card

3 Description

The TPDxE05U06-Q1 is a family of unidirectional Transient Voltage Suppressor (TVS) Electrostatic Discharge (ESD) protection diodes with ultra-low capacitance. They are rated to dissipate ESD strikes above the maximum level specified in the IEC 61000-4-2 level 4 international standard. The ultra-low loading capacitance makes these devices ideal for protecting any high-speed signal applications up to 6 Gbps.

These devices are also available without automotive qualification: [TPDxE05U06](#).

Device Information⁽¹⁾

PART NUMBER	PACKAGE	BODY SIZE (NOM)
TPD4E05U06-Q1	USON (10)	2.50 mm x 1.00 mm
TPD1E05U06-Q1	X1SON (2)	0.60 mm x 1.00 mm

(1) For all available packages, see the orderable addendum at the end of the datasheet.

TPD4E05U06-Q1 Block Diagram

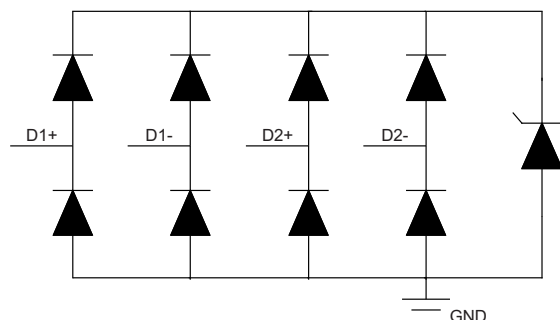

Table of Contents

1 Features	1	7.4 Device Functional Modes.....	9
2 Applications	1	8 Application and Implementation	10
3 Description	1	8.1 Application Information.....	10
4 Revision History	2	8.2 Typical Application	10
5 Pin Configuration and Functions	3	9 Layout	12
6 Specifications	4	9.1 Layout Guidelines	12
6.1 Absolute Maximum Ratings	4	9.2 Layout Example	12
6.2 ESD Ratings—AEC Specification	4	10 Device and Documentation Support	13
6.3 ESD Ratings—IEC Specification	4	10.1 Documentation Support	13
6.4 Recommended Operating Conditions.....	4	10.2 Receiving Notification of Documentation Updates	13
6.5 Thermal Information	4	10.3 Related Links	13
6.6 Electrical Characteristics.....	5	10.4 Community Resources.....	13
6.7 Typical Characteristics.....	6	10.5 Trademarks	13
7 Detailed Description	8	10.6 Electrostatic Discharge Caution.....	13
7.1 Overview	8	10.7 Glossary	13
7.2 Functional Block Diagram	8	11 Mechanical, Packaging, and Orderable	14
7.3 Feature Description.....	8	Information	14

4 Revision History

Changes from Revision A (August 2014) to Revision B	Page
• Added 1-channel (TPD1E05U06-Q1) package	1
• Added DPY package information in <i>Thermal Information</i> table	4
• Added DPY package Dynamic resistance in <i>Electrical Characteristics</i> table	5
• Added DPY package Line capacitance in <i>Electrical Characteristics</i> table.....	5

Changes from Revision B (August 2016) to Revision C	Page
• Changed DPY Package pin configuration in the <i>Pin Configuration and Functions</i> section	1

Changes from Original (August 2014) to Revision A	Page
• Added (See the <i>ESD Ratings—IEC Specification Table</i>) to Feature: IEC 61000-4-2 Level 4 ESD Protection	1

5 Pin Configuration and Functions

**DPY Package
2-Pin X1SON
Top View**

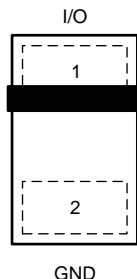

**DQA Package
10-Pin USON
Top View**

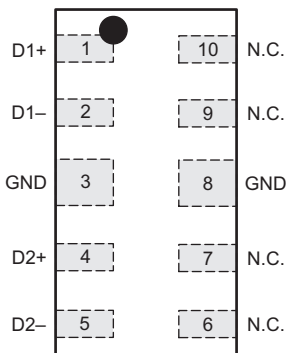

Pin Functions TPD1E05U06-Q1 DPY

PIN		TYPE	DESCRIPTION
NO.	NAME		
1	I/O	I/O	ESD Protected Channel ⁽¹⁾
2	GND	Ground	Ground; Connect to ground

(1) Place as close to the connector as possible.

Pin Functions TPD4E05U06-Q1 DQA

PIN		TYPE	DESCRIPTION
NO.	NAME		
1	D1+	I/O	ESD Protected Channel ⁽¹⁾
2	D1–	I/O	ESD Protected Channel ⁽¹⁾
4	D2+	I/O	ESD Protected Channel ⁽¹⁾
5	D2–	I/O	ESD Protected Channel ⁽¹⁾
6, 7, 9, 10	NC	NC	Not Connected; Used for optional straight-through routing. Can be left floating or grounded
3, 8	GND	Ground	Ground; Connect to ground

(1) Place as close to the connector as possible.

6 Specifications

6.1 Absolute Maximum Ratings

 over operating free-air temperature range (unless otherwise noted) ⁽¹⁾⁽²⁾

		MIN	MAX	UNIT
Electrical fast transient	IEC 61000-4-4 (5/50 ns)		80	A
Peak pulse	IEC 61000-4-5 Current (tp – 8/20 μs)		2.5	A
	IEC 61000-4-5 Power (tp – 8/20 μs) - TPD4E05U06-Q1 ⁽³⁾		40	W
	IEC 61000-4-5 Power (tp – 8/20 μs) - TPD1E05U06-Q1 ⁽³⁾		30	W
T _A	Operating temperature	–40	125	°C
T _{stg}	Storage temperature	–65	150	°C

- (1) Stresses beyond those listed under *Absolute Maximum Ratings* may cause permanent damage to the device. These are stress ratings only, which do not imply functional operation of the device at these or any other conditions beyond those indicated under *Recommended Operating Conditions*. Exposure to absolute-maximum-rated conditions for extended periods may affect device reliability.
- (2) Voltages are with respect to GND unless otherwise noted.
- (3) Measured at 25°C

6.2 ESD Ratings—AEC Specification

		VALUE	UNIT
V _(ESD)	Electrostatic discharge ⁽¹⁾	Human-body model (HBM), per AEC Q100-002 ⁽²⁾	±8000
		Charged-device model (CDM), per AEC Q100-011	±1000

- (1) Electrostatic discharge (ESD) to measure device sensitivity and immunity to damage caused by assembly line electrostatic discharges into the device.
- (2) AEC Q100-002 indicates that HBM stressing shall be in accordance with the ANSI/ESDA/JEDEC JS-001 specification.

6.3 ESD Ratings—IEC Specification

		VALUE	UNIT
V(ESD)	Electrostatic Discharge	IEC 61000-4-2 contact discharge - TPD4E05U06-Q1 ⁽¹⁾	±12000
		IEC 61000-4-2 contact discharge - TPD1E05U06-Q1	±12000
		IEC 61000-4-2 air-gap discharge	±15000

- (1) Measured at 25°C, per IEC 61000.4.2 Ed. 2.0 Section 7.2.4.

6.4 Recommended Operating Conditions

over operating free-air temperature range (unless otherwise noted)

		MIN	MAX	UNIT
V _{IO}	Input pin voltage	0	5.5	V
T _A	Operating free-air temperature	–40	125	°C

6.5 Thermal Information

THERMAL METRIC ⁽¹⁾		TPD1E05U06-Q1	TPD4E05U06-Q1	UNIT
		DPY (X1SON)	DQA (USON)	
		2 PINS	10 PINS	
R _{θJA}	Junction-to-ambient thermal resistance	697.3	327	°C/W
R _{θJC(top)}	Junction-to-case (top) thermal resistance	471	189.5	°C/W
R _{θJB}	Junction-to-board thermal resistance	575.9	257.7	°C/W
ψ _{JT}	Junction-to-top characterization parameter	175.7	60.9	°C/W
ψ _{JB}	Junction-to-board characterization parameter	575.1	257	°C/W

- (1) For more information about traditional and new thermal metrics, see the [Semiconductor and IC Package Thermal Metrics](#) application report.

6.6 Electrical Characteristics

over operating free-air temperature range (unless otherwise noted)

PARAMETER		TEST CONDITIONS	MIN	TYP	MAX	UNIT
INPUT – OUTPUT RESISTANCE						
V_{RWM}	Reverse stand-off voltage	$I_{IO} < 10 \mu A$			5.5	V
V_{BR}	Break-down voltage	$I_{IO} = 1 \text{ mA}$	6.4		8.7	V
V_{CLAMP}	Clamp voltage	$I_{PP} = 1 \text{ A}$, TLP, from I/O to GND ⁽¹⁾		10		V
		$I_{PP} = 5 \text{ A}$, TLP, from I/O to GND ⁽¹⁾		14		
		$I_{PP} = 1 \text{ A}$, TLP, from GND to I/O ⁽¹⁾		3		
		$I_{PP} = 5 \text{ A}$, TLP, from GND to I/O ⁽¹⁾		7.5		
I_{LEAK}	Leakage current	$V_{IO} = 2.5 \text{ V}$		1	10	nA
R_{DYN}	Dynamic resistance	DPY package	I/O to GND ⁽²⁾		0.8	Ω
			GND to I/O ⁽²⁾		0.7	
		DQA package	I/O to GND ⁽²⁾		0.96	
			GND to I/O ⁽²⁾		0.9	
CAPACITANCE						
C_L	Line capacitance	$V_{IO} = 2.5 \text{ V}$, $f = 1 \text{ MHz}$, I/O to GND	TPD1E05U06-Q1 DPY package		0.42	pF
			TPD4E05U06-Q1 DQA package		0.5	
$\Delta C_{IO-TO-GND}$	Variation of input capacitance	GND Pin = 0 V, $f = 1 \text{ MHz}$, $V_{BIAS} = 2.5 \text{ V}$, Channel x pin to GND – channel y pin to GND		0.05	0.08	pF
C_{CROSS}	Channel to channel input capacitance	GND Pin = 0 V, $f = 1 \text{ MHz}$, $V_{BIAS} = 2.5 \text{ V}$, between channel pins		0.04	0.08	pF

(1) Transition line pulse with 100 ns width, 200 ps rise time.

 (2) Extraction of R_{DYN} using least squares fit of TLP characteristics between $I = 5 \text{ A}$ and $I = 10 \text{ A}$.

6.7 Typical Characteristics

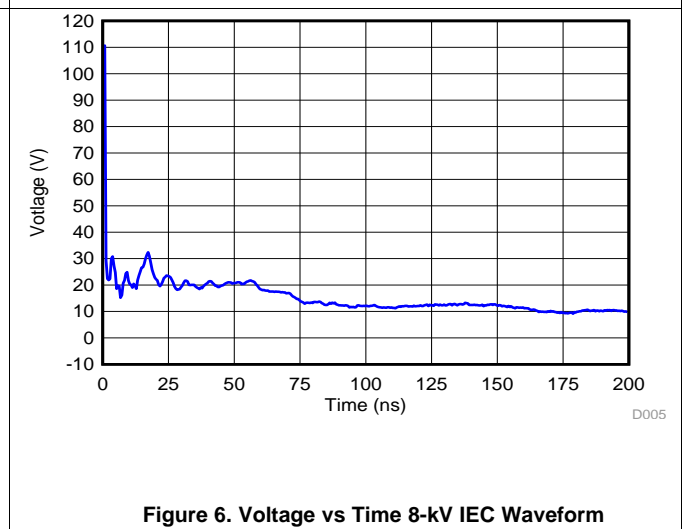
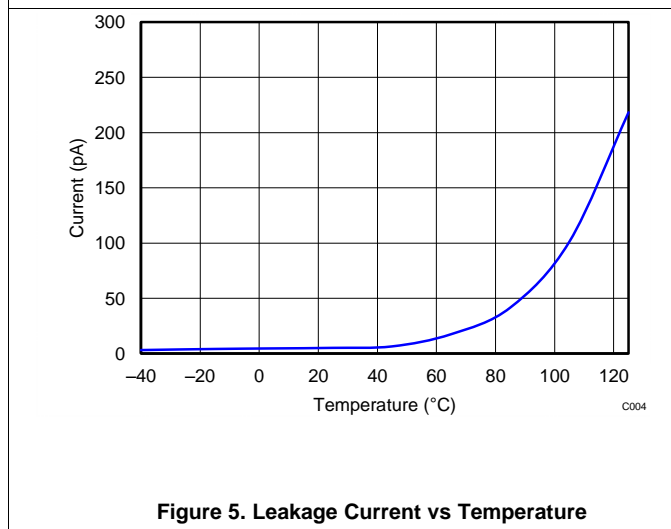
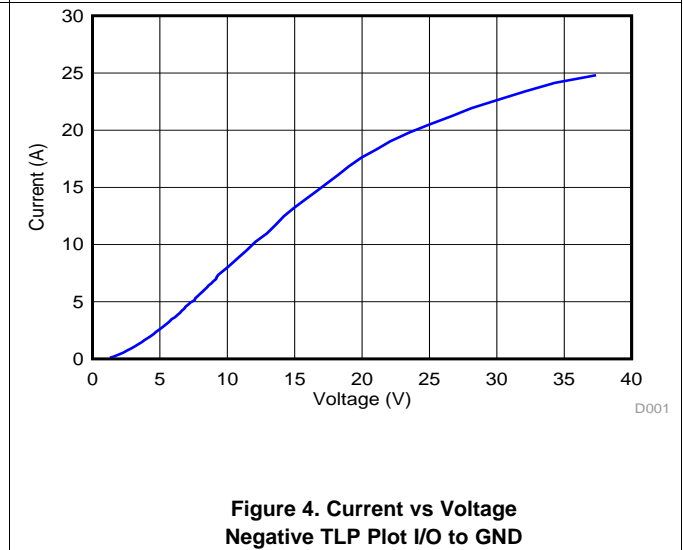
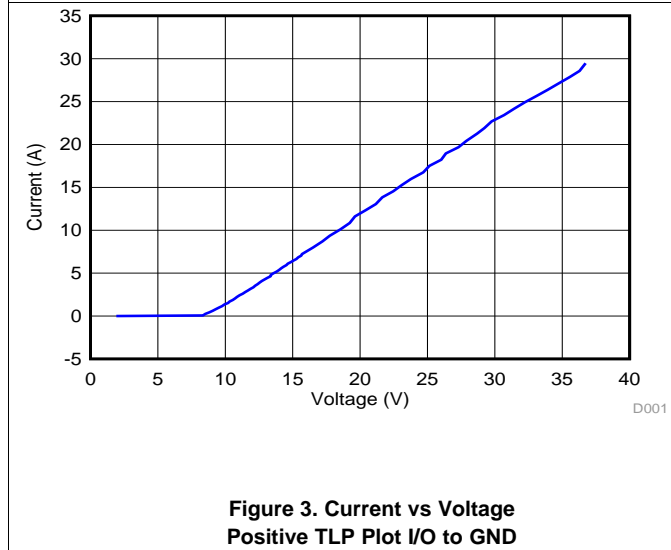
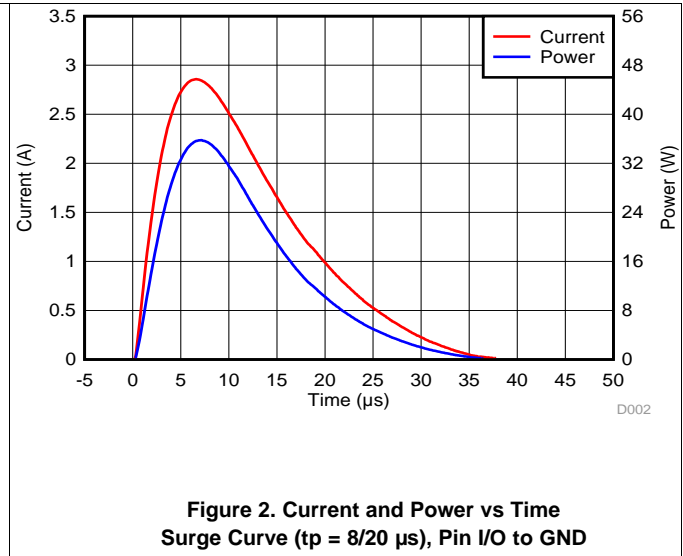
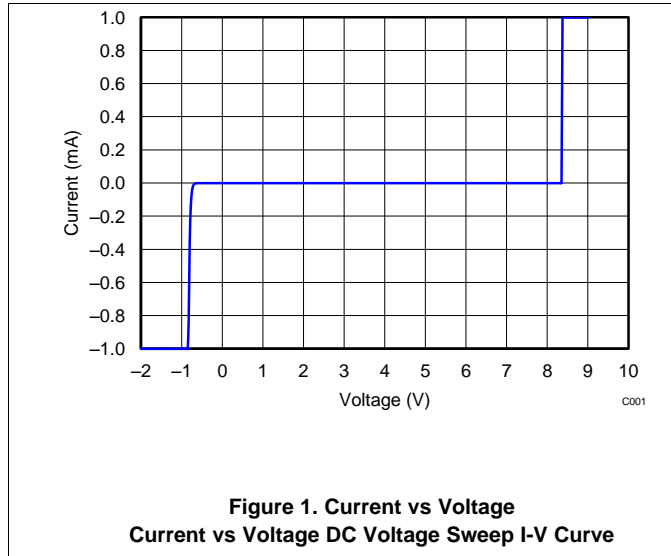

Typical Characteristics (continued)

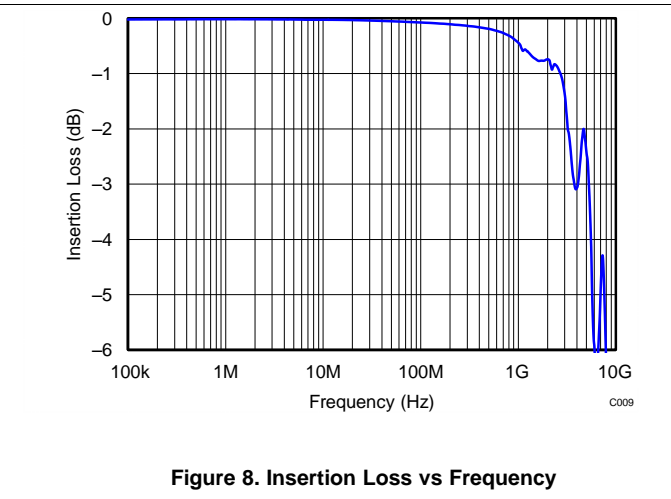
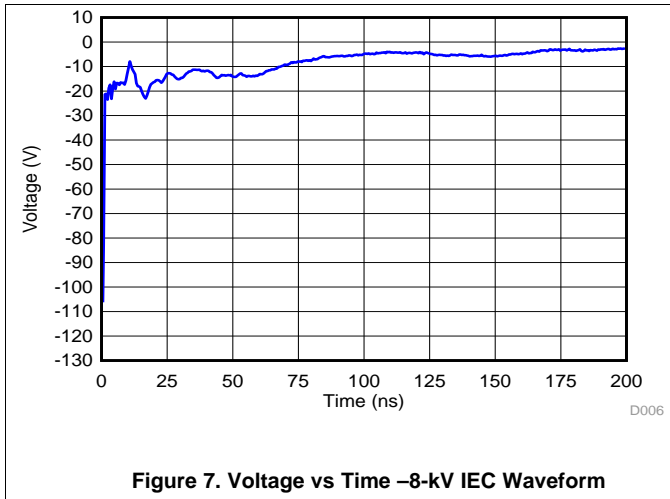

7 Detailed Description

7.1 Overview

The TPDxE05U06-Q1 is a family of unidirectional TVS ESD protection diode arrays with ultra-low capacitance between 0.42 pF and 0.5 pF. They are rated to dissipate ESD strikes above the maximum level specified in the IEC 61000-4-2 level 4 international standard (12-kV contact, 15-kV air gap). The ultra-low loading capacitance makes them ideal for protecting any high-speed signal applications up to 6 Gbps.

7.2 Functional Block Diagram

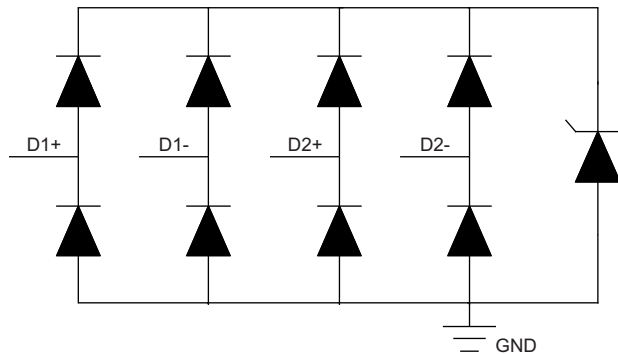

Figure 9. TPD4E05U06-Q1 Block Diagram

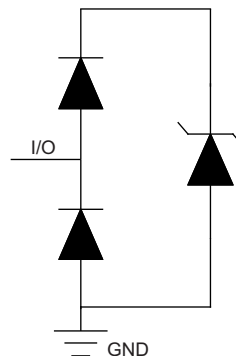

Figure 10. TPD1E05U06-Q1 Block Diagram

7.3 Feature Description

7.3.1 AEC-Q101 Qualification

These devices are qualified to AEC-Q101 standards. They pass HBM H3B (± 8 kV) and CDM C5 (± 1 kV) ESD ratings and are qualified to operate from -40°C to $+125^{\circ}\text{C}$.

7.3.2 IEC 61000-4-2 Level 4 ESD Protection

The I/O pins can withstand ESD events up to ± 12 -kV contact and ± 15 -kV air. An ESD-surge clamp diverts the current to ground.

7.3.3 IEC 61000-4-4 EFT Protection

The I/O pins can withstand an electrical fast transient burst of up to 80 A (5/50 ns waveform, 4 kV with 50- Ω impedance). An ESD-surge clamp diverts the current to ground.

Feature Description (continued)

7.3.4 IEC 61000-4-5 Surge Protection

The I/O pins can withstand surge events up to 2.5 A and 40 W (8/20 μ s waveform). An ESD-surge clamp diverts this current to ground.

7.3.5 I/O Capacitance

The capacitance between each I/O pin to ground is 0.5 pF. These capacitances support data rates up to 5 Gbps.

7.3.6 DC Breakdown Voltage

The DC breakdown voltage of each I/O pin is a minimum of 6.4 V. This ensures that sensitive equipment is protected from surges above the reverse standoff voltage of 5 V.

7.3.7 Ultra-Low Leakage Current

The I/O pins feature an ultra-low leakage current of 10 nA (Maximum) with a bias of 2.5 V.

7.3.8 Low ESD Clamping Voltage

The I/O pins feature an ESD clamp that is capable of clamping the voltage to 10 V ($I_{PP} = 1$ A).

7.3.9 Easy Flow-Through Routing

The layout of this device makes it simple and easy to add protection to an existing layout. The packages offers flow-through routing, requiring minimal modification to an existing layout.

7.4 Device Functional Modes

The TPDxE05U06-Q1 are passive integrated circuits that triggers when voltages are above V_{BR} or below the lower diodes V_f (-0.6 V). During ESD events, voltages as high as ± 15 kV (air) can be directed to ground via the internal diode network. When the voltages on the protected line fall below the trigger levels of TPDxE05U06-Q1 (usually within 10s of nano-seconds) the devices reverts to passive.

8 Application and Implementation

8.1 Application Information

The TPD4E05U06-Q1 is a diode type TVS which is typically used to provide a path to ground for dissipating ESD events on hi-speed signal lines between a human interface connector and a system. As the current from ESD passes through the TVS, only a small voltage drop is present across the diode. This is the voltage presented to the protected IC. The low R_{DYN} of the triggered TVS holds this voltage, V_{CLAMP} , to a safe level for the protected IC.

8.2 Typical Application

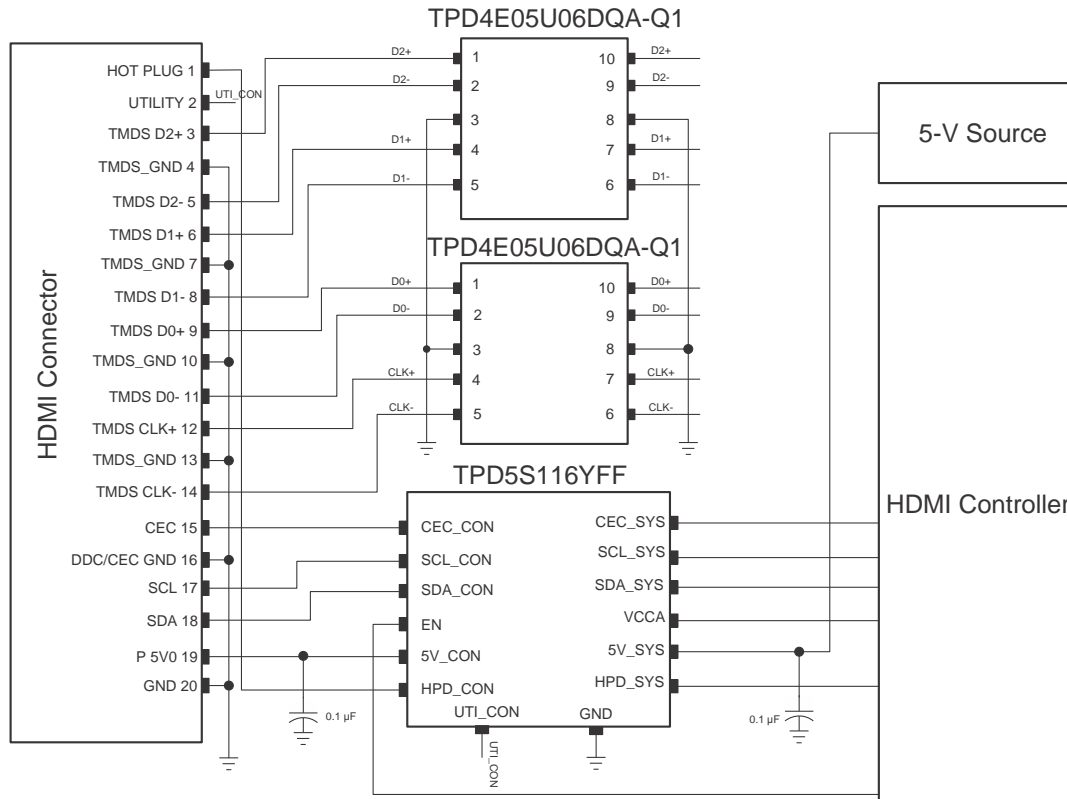

Copyright © 2016, Texas Instruments Incorporated

Figure 11. HDMI 1.4 Application

8.2.1 Design Requirements

For this design example, two TPD4E05U06-Q1 devices, and a TPD5S116 are being used in an HDMI 1.4 application. This provides a complete port protection scheme.

Given the HDMI 1.4 application, the parameters in [Table 1](#) are known.

Table 1. Design Parameters

DESIGN PARAMETER	VALUE
Signal range on pins 1, 2, 4, or 5	0 V to 5 V
Operating frequency	1.7 GHz

8.2.2 Detailed Design Procedure

To begin the design process, some parameters must be decided upon; the designer needs to know the following:

- Signal range on all the protected lines
- Operating frequency

8.2.2.1 Signal Range on Pin 1, 2, 4, or 5

The TPD4E05U06-Q1 has 4 identical protection channels for signal lines. The symmetry of the device provides flexibility when selecting which of the 4 I/O channels protect which signal lines. Any I/O will support a signal range of 0 to 5.5 V.

8.2.2.2 Operating Frequency

The TPD4E05U06-Q1 has a capacitance of 0.5 pF (Typical), supporting HDMI 1.4 data rates.

8.2.3 Application Curve

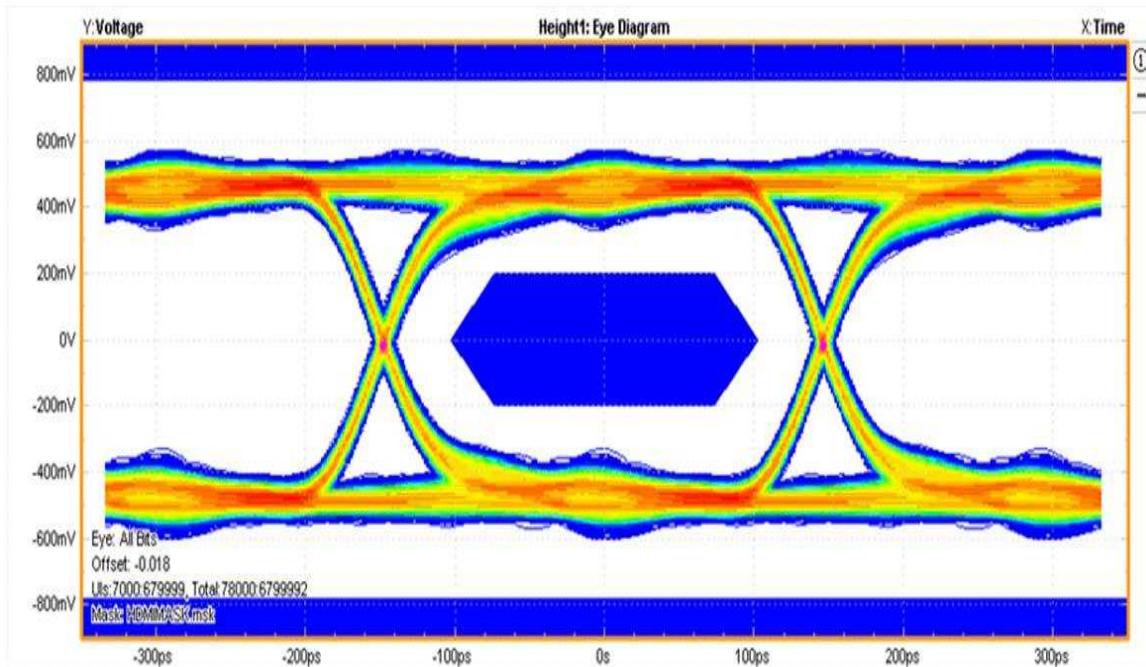

Figure 12. 3.4 Gbps HDMI Eye Diagram

9 Layout

9.1 Layout Guidelines

- The optimum placement is as close to the connector as possible.
 - EMI during an ESD event can couple from the trace being struck to other nearby unprotected traces, resulting in early system failures.
 - The PCB designer needs to minimize the possibility of EMI coupling by keeping any unprotected traces away from the protected traces which are between the TVS and the connector.
- Route the protected traces as straight as possible.
- Eliminate any sharp corners on the protected traces between the TVS and the connector by using rounded corners with the largest radii possible.
 - Electric fields tend to build up on corners, increasing EMI coupling.

9.2 Layout Example

This application is typical of an HDMI 1.4 layout.

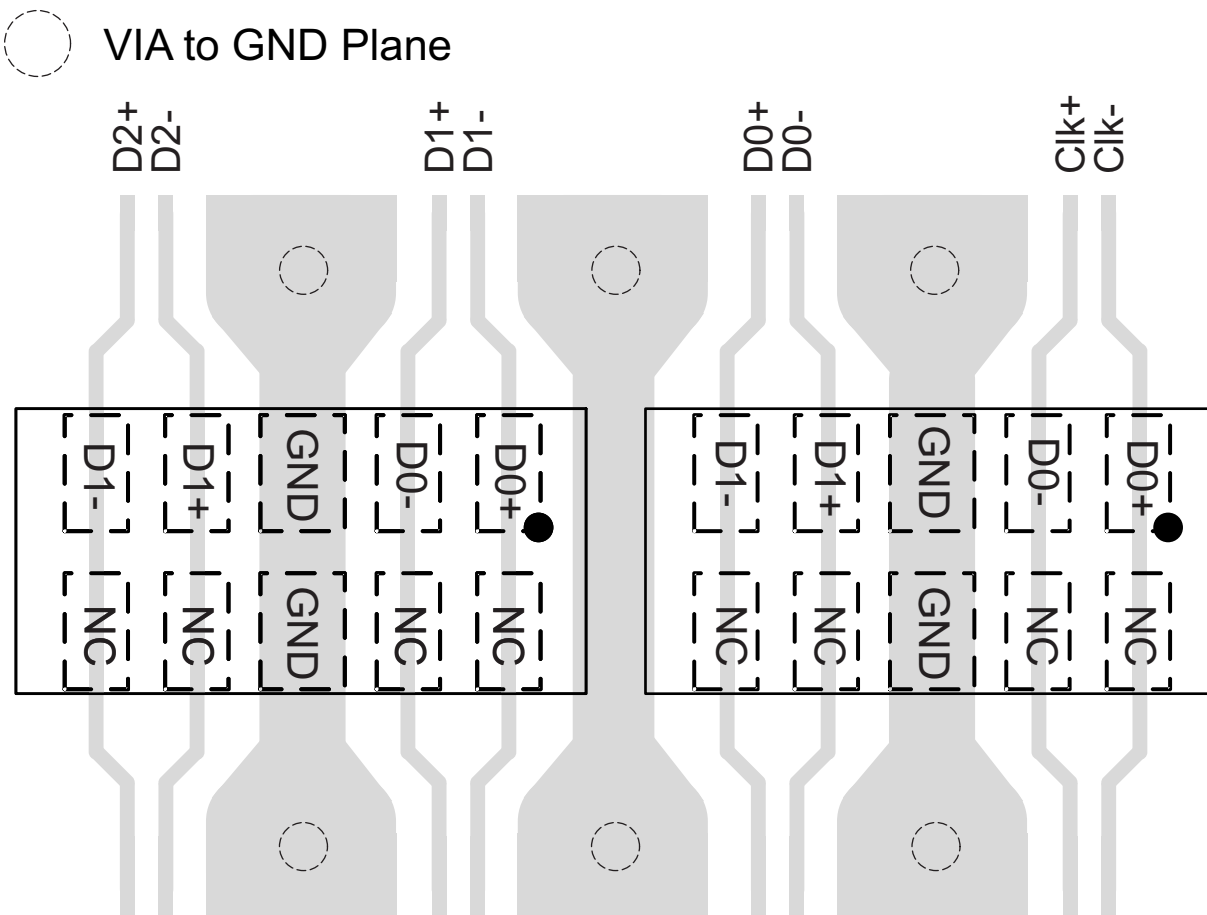

Figure 13. TPD4E05U06-Q1 Layout

10 Device and Documentation Support

10.1 Documentation Support

10.1.1 Related Documentation

For related documentation see the following:

- [TPD1E05U06-Q1 Evaluation Module User's Guide](#)
- [Reading and Understanding an ESD Protection Datasheet](#)
- [ESD Layout Guide](#)
- [TPD4E05U06DQA EVM User's Guide](#)

10.2 Receiving Notification of Documentation Updates

To receive notification of documentation updates, navigate to the device product folder on ti.com. In the upper right corner, click on *Alert me* to register and receive a weekly digest of any product information that has changed. For change details, review the revision history included in any revised document.

10.3 Related Links

The table below lists quick access links. Categories include technical documents, support and community resources, tools and software, and quick access to sample or buy.

Table 2. Related Links

PARTS	PRODUCT FOLDER	SAMPLE & BUY	TECHNICAL DOCUMENTS	TOOLS & SOFTWARE	SUPPORT & COMMUNITY
TPD4E05U06-Q1	Click here	Click here	Click here	Click here	Click here
TPD1E05U06-Q1	Click here	Click here	Click here	Click here	Click here

10.4 Community Resources

The following links connect to TI community resources. Linked contents are provided "AS IS" by the respective contributors. They do not constitute TI specifications and do not necessarily reflect TI's views; see TI's [Terms of Use](#).

TI E2E™ Online Community *TI's Engineer-to-Engineer (E2E) Community*. Created to foster collaboration among engineers. At e2e.ti.com, you can ask questions, share knowledge, explore ideas and help solve problems with fellow engineers.

Design Support *TI's Design Support* Quickly find helpful E2E forums along with design support tools and contact information for technical support.

10.5 Trademarks

E2E is a trademark of Texas Instruments.
All other trademarks are the property of their respective owners.

10.6 Electrostatic Discharge Caution



This integrated circuit can be damaged by ESD. Texas Instruments recommends that all integrated circuits be handled with appropriate precautions. Failure to observe proper handling and installation procedures can cause damage.

ESD damage can range from subtle performance degradation to complete device failure. Precision integrated circuits may be more susceptible to damage because very small parametric changes could cause the device not to meet its published specifications.

10.7 Glossary

SLYZ022 — *TI Glossary*.

This glossary lists and explains terms, acronyms, and definitions.

11 Mechanical, Packaging, and Orderable Information

The following pages include mechanical, packaging, and orderable information. This information is the most current data available for the designated devices. This data is subject to change without notice and revision of this document. For browser-based versions of this data sheet, refer to the left-hand navigation.

PACKAGING INFORMATION

Orderable Device	Status (1)	Package Type	Package Drawing	Pins	Package Qty	Eco Plan (2)	Lead finish/ Ball material (6)	MSL Peak Temp (3)	Op Temp (°C)	Device Marking (4/5)	Samples
TPD1E05U06QDPYRQ1	ACTIVE	X1SON	DPY	2	10000	RoHS & Green	NIPDAU	Level-1-260C-UNLIM	-40 to 125	40	Samples
TPD4E05U06QDQARQ1	ACTIVE	USON	DQA	10	3000	RoHS & Green	NIPDAU NIPDAUAG	Level-2-260C-1 YEAR	-40 to 125	(BRH, CQ1)	Samples

(1) The marketing status values are defined as follows:

ACTIVE: Product device recommended for new designs.

LIFEBUY: TI has announced that the device will be discontinued, and a lifetime-buy period is in effect.

NRND: Not recommended for new designs. Device is in production to support existing customers, but TI does not recommend using this part in a new design.

PREVIEW: Device has been announced but is not in production. Samples may or may not be available.

OBsolete: TI has discontinued the production of the device.

(2) **RoHS:** TI defines "RoHS" to mean semiconductor products that are compliant with the current EU RoHS requirements for all 10 RoHS substances, including the requirement that RoHS substance do not exceed 0.1% by weight in homogeneous materials. Where designed to be soldered at high temperatures, "RoHS" products are suitable for use in specified lead-free processes. TI may reference these types of products as "Pb-Free".

RoHS Exempt: TI defines "RoHS Exempt" to mean products that contain lead but are compliant with EU RoHS pursuant to a specific EU RoHS exemption.

Green: TI defines "Green" to mean the content of Chlorine (Cl) and Bromine (Br) based flame retardants meet JS709B low halogen requirements of <=1000ppm threshold. Antimony trioxide based flame retardants must also meet the <=1000ppm threshold requirement.

(3) MSL, Peak Temp. - The Moisture Sensitivity Level rating according to the JEDEC industry standard classifications, and peak solder temperature.

(4) There may be additional marking, which relates to the logo, the lot trace code information, or the environmental category on the device.

(5) Multiple Device Markings will be inside parentheses. Only one Device Marking contained in parentheses and separated by a "~" will appear on a device. If a line is indented then it is a continuation of the previous line and the two combined represent the entire Device Marking for that device.

(6) Lead finish/Ball material - Orderable Devices may have multiple material finish options. Finish options are separated by a vertical ruled line. Lead finish/Ball material values may wrap to two lines if the finish value exceeds the maximum column width.

Important Information and Disclaimer:The information provided on this page represents TI's knowledge and belief as of the date that it is provided. TI bases its knowledge and belief on information provided by third parties, and makes no representation or warranty as to the accuracy of such information. Efforts are underway to better integrate information from third parties. TI has taken and continues to take reasonable steps to provide representative and accurate information but may not have conducted destructive testing or chemical analysis on incoming materials and chemicals. TI and TI suppliers consider certain information to be proprietary, and thus CAS numbers and other limited information may not be available for release.

In no event shall TI's liability arising out of such information exceed the total purchase price of the TI part(s) at issue in this document sold by TI to Customer on an annual basis.

OTHER QUALIFIED VERSIONS OF TPD1E05U06-Q1, TPD4E05U06-Q1 :

- Catalog: [TPD1E05U06](#), [TPD4E05U06](#)

NOTE: Qualified Version Definitions:

- Catalog - TI's standard catalog product

TAPE AND REEL INFORMATION

QUADRANT ASSIGNMENTS FOR PIN 1 ORIENTATION IN TAPE

*All dimensions are nominal

Device	Package Type	Package Drawing	Pins	SPQ	Reel Diameter (mm)	Reel Width W1 (mm)	A0 (mm)	B0 (mm)	K0 (mm)	P1 (mm)	W (mm)	Pin1 Quadrant
TPD1E05U06QDPYRQ1	X1SON	DPY	2	10000	180.0	9.5	0.73	1.13	0.5	2.0	8.0	Q1
TPD4E05U06QDQARQ1	USON	DQA	10	3000	180.0	9.5	1.18	2.68	0.72	4.0	8.0	Q1
TPD4E05U06QDQARQ1	USON	DQA	10	3000	180.0	8.4	1.3	2.83	0.65	4.0	8.0	Q1

TAPE AND REEL BOX DIMENSIONS



*All dimensions are nominal

Device	Package Type	Package Drawing	Pins	SPQ	Length (mm)	Width (mm)	Height (mm)
TPD1E05U06QDPYRQ1	X1SON	DPY	2	10000	189.0	185.0	36.0
TPD4E05U06QDQARQ1	USON	DQA	10	3000	189.0	185.0	36.0
TPD4E05U06QDQARQ1	USON	DQA	10	3000	213.0	191.0	35.0

DPY (R-PX1SON-N2)

PLASTIC SMALL OUTLINE NO-LEAD

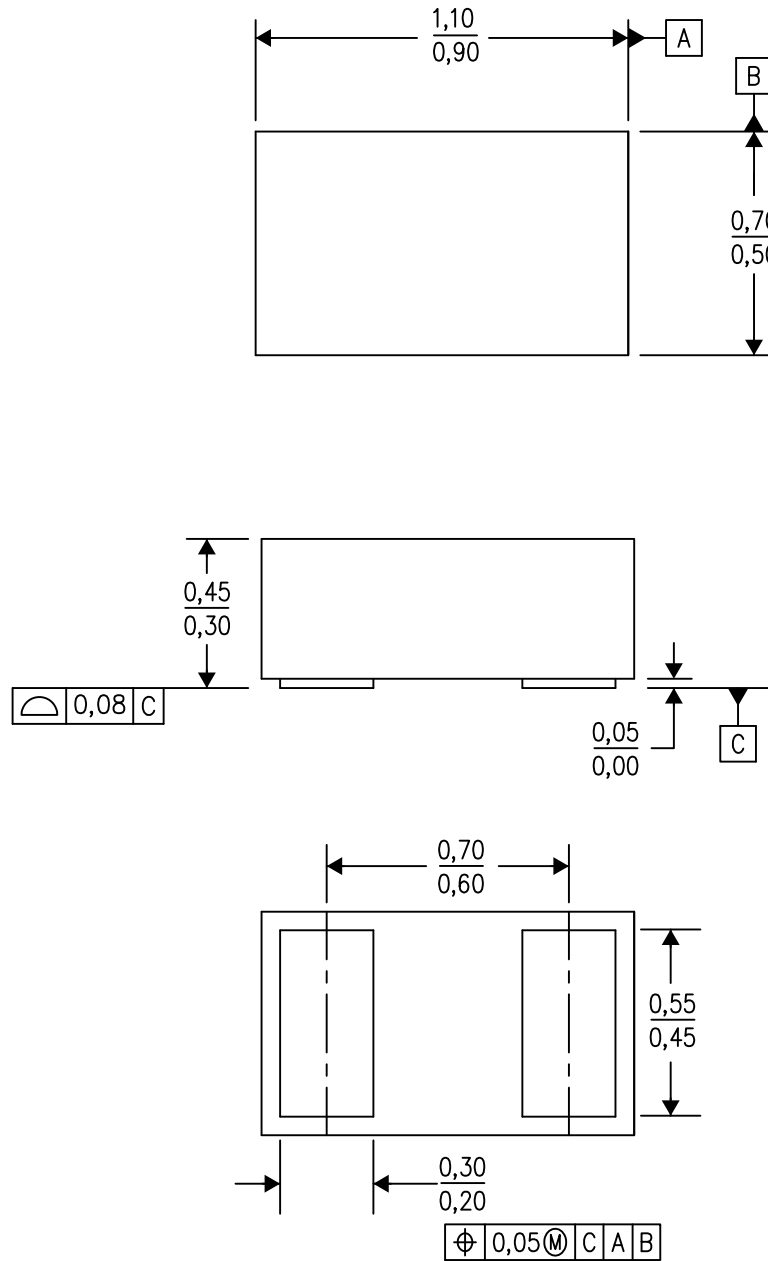

4211012/D 08/14

- NOTES:
- All linear dimensions are in millimeters. Dimensioning and tolerancing per ASME Y14.5-1994.
 - This drawing is subject to change without notice.
 - SON (Small Outline No-Lead) package configuration.

DPY0002A

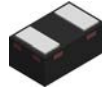

PACKAGE OUTLINE

X1SON - 0.45 mm max height

PLASTIC SMALL OUTLINE - NO LEAD

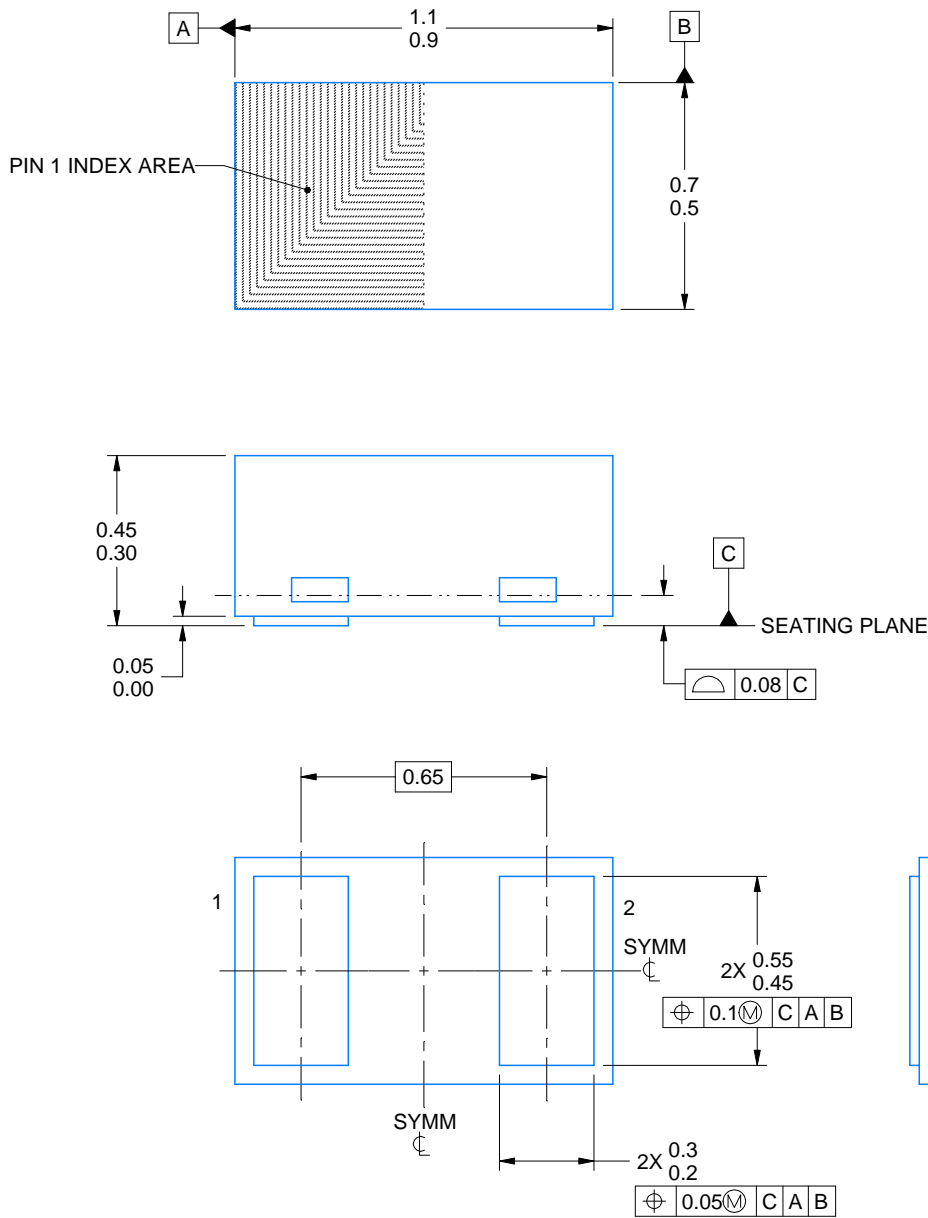

4224561/B 03/2021

NOTES:

1. All linear dimensions are in millimeters. Any dimensions in parenthesis are for reference only. Dimensioning and tolerancing per ASME Y14.5M
2. This drawing is subject to change without notice.

EXAMPLE BOARD LAYOUT

DPY0002A

X1SON - 0.45 mm max height

PLASTIC SMALL OUTLINE - NO LEAD

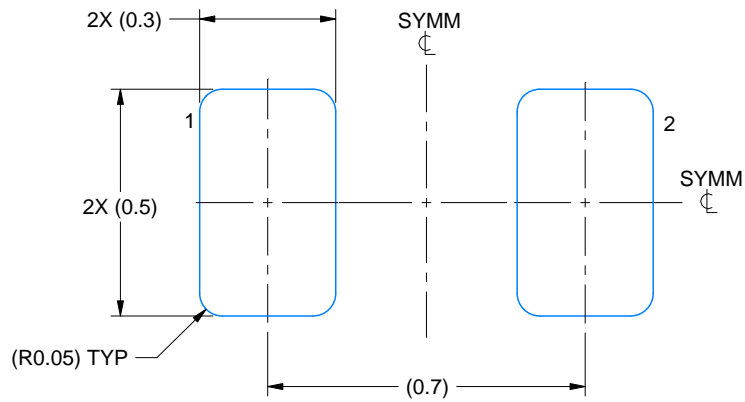

LAND PATTERN EXAMPLE
EXPOSED METAL SHOWN
SCALE:60X

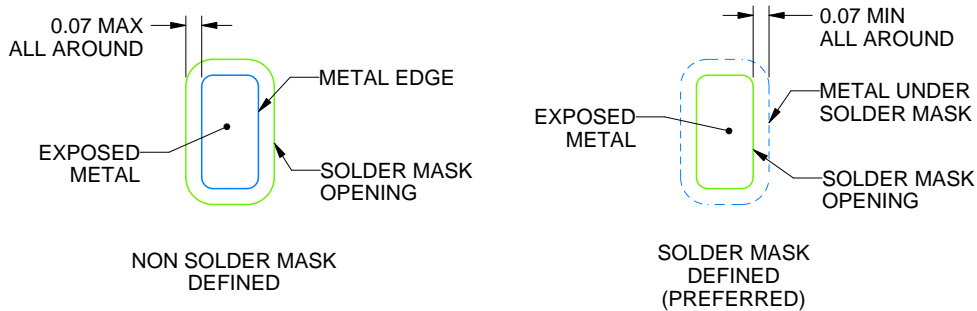

SOLDER MASK DETAILS

4224561/B 03/2021

NOTES: (continued)

3. For more information, see Texas Instruments literature number SLUA271 (www.ti.com/lit/sl原因271).
4. Vias are optional depending on application, refer to device data sheet. If any vias are implemented, refer to their locations shown on this view. It is recommended that vias under paste be filled, plugged or tented.

EXAMPLE STENCIL DESIGN

DPY0002A

X1SON - 0.45 mm max height

PLASTIC SMALL OUTLINE - NO LEAD

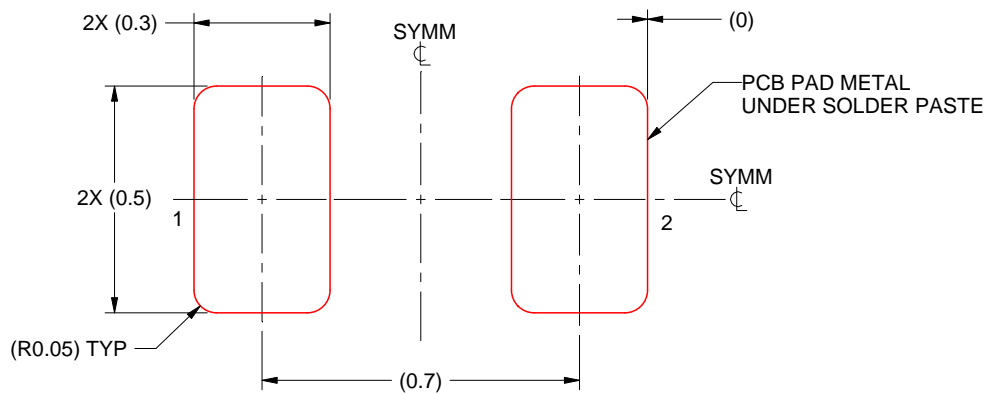

SOLDER PASTE EXAMPLE
BASED ON 0.1 mm THICK STENCIL
SCALE:60X

4224561/B 03/2021

NOTES: (continued)

5. Laser cutting apertures with trapezoidal walls and rounded corners may offer better paste release. IPC-7525 may have alternate design recommendations.

GENERIC PACKAGE VIEW

DQA 10

USON - 0.55 mm max height

1 x 2.5, 0.5 mm pitch

PLASTIC SMALL OUTLINE - NO LEAD

This image is a representation of the package family, actual package may vary.
Refer to the product data sheet for package details.

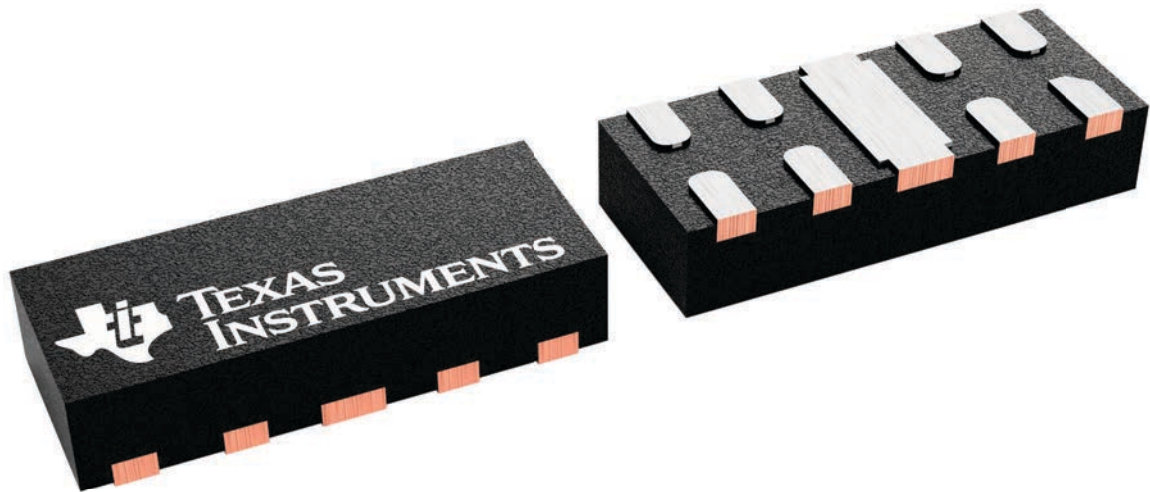

4230320/A

EXAMPLE BOARD LAYOUT

DQA0010A

USON - 0.55 mm max height

PLASTIC SMALL OUTLINE - NO LEAD

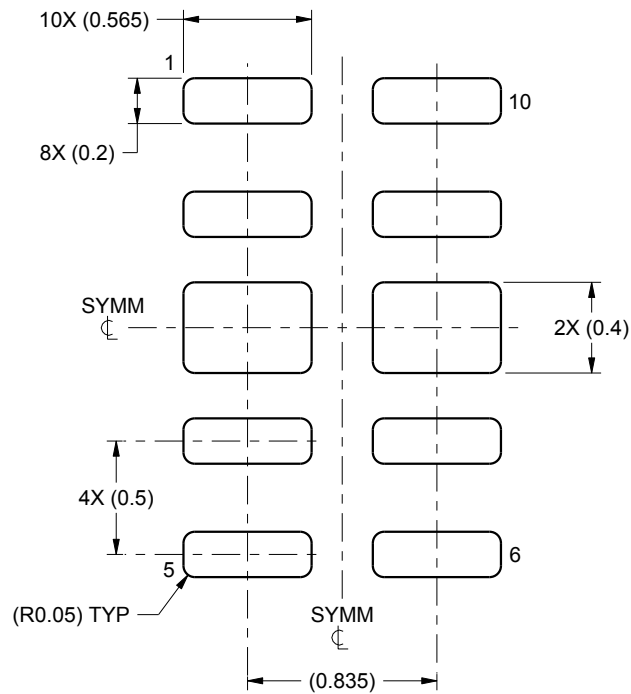

LAND PATTERN EXAMPLE
SCALE:30X

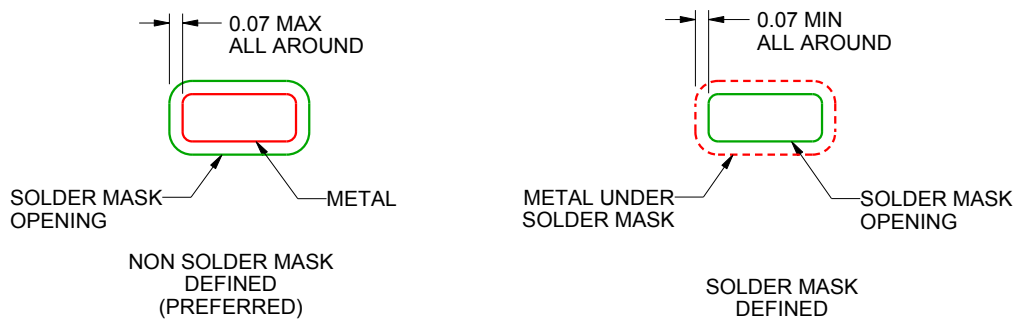

SOLDER MASK DETAILS

4220328/A 12/2015

NOTES: (continued)

3. For more information, see Texas Instruments literature number SLUA271 (www.ti.com/lit/slua271).

EXAMPLE STENCIL DESIGN

DQA0010A

USON - 0.55 mm max height

PLASTIC SMALL OUTLINE - NO LEAD

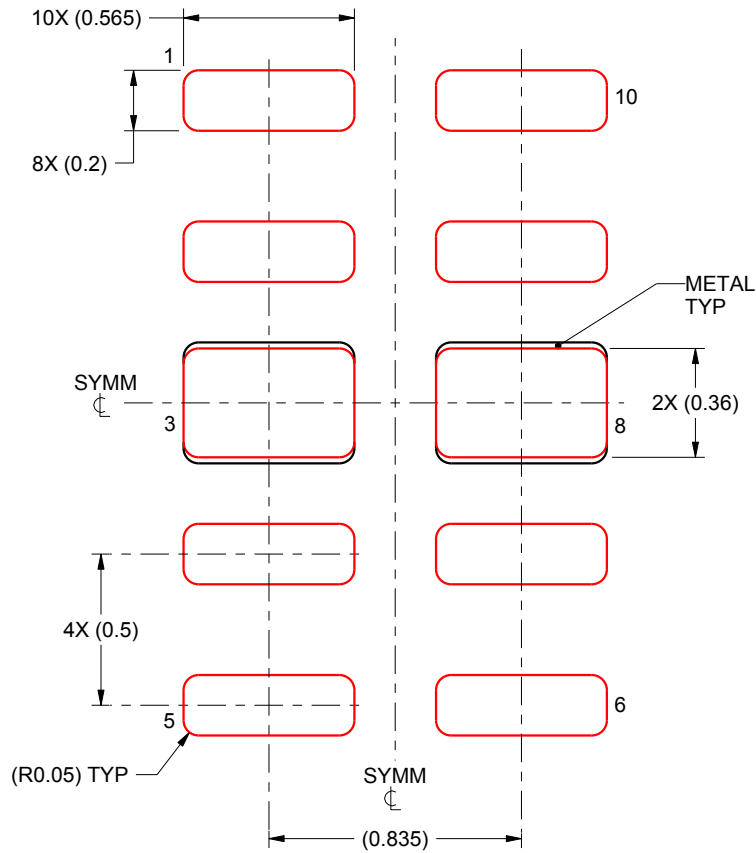

SOLDER PASTE EXAMPLE
BASED ON 0.1 mm THICK STENCIL

EXPOSED PADS 3 & 8:
90% PRINTED SOLDER COVERAGE BY AREA UNDER PACKAGE
SCALE:40X

4220328/A 12/2015

NOTES: (continued)

4. Laser cutting apertures with trapezoidal walls and rounded corners may offer better paste release. IPC-7525 may have alternate design recommendations.

IMPORTANT NOTICE AND DISCLAIMER

TI PROVIDES TECHNICAL AND RELIABILITY DATA (INCLUDING DATA SHEETS), DESIGN RESOURCES (INCLUDING REFERENCE DESIGNS), APPLICATION OR OTHER DESIGN ADVICE, WEB TOOLS, SAFETY INFORMATION, AND OTHER RESOURCES "AS IS" AND WITH ALL FAULTS, AND DISCLAIMS ALL WARRANTIES, EXPRESS AND IMPLIED, INCLUDING WITHOUT LIMITATION ANY IMPLIED WARRANTIES OF MERCHANTABILITY, FITNESS FOR A PARTICULAR PURPOSE OR NON-INFRINGEMENT OF THIRD PARTY INTELLECTUAL PROPERTY RIGHTS.

These resources are intended for skilled developers designing with TI products. You are solely responsible for (1) selecting the appropriate TI products for your application, (2) designing, validating and testing your application, and (3) ensuring your application meets applicable standards, and any other safety, security, regulatory or other requirements.

These resources are subject to change without notice. TI grants you permission to use these resources only for development of an application that uses the TI products described in the resource. Other reproduction and display of these resources is prohibited. No license is granted to any other TI intellectual property right or to any third party intellectual property right. TI disclaims responsibility for, and you will fully indemnify TI and its representatives against, any claims, damages, costs, losses, and liabilities arising out of your use of these resources.

TI's products are provided subject to [TI's Terms of Sale](#) or other applicable terms available either on [ti.com](https://www.ti.com) or provided in conjunction with such TI products. TI's provision of these resources does not expand or otherwise alter TI's applicable warranties or warranty disclaimers for TI products.

TI objects to and rejects any additional or different terms you may have proposed.

Mailing Address: Texas Instruments, Post Office Box 655303, Dallas, Texas 75265
Copyright © 2023, Texas Instruments Incorporated

单击下面可查看定价，库存，交付和生命周期等信息

[>>TI\(德州仪器\)](#)