

## TPS6208x 1.2-A High-Efficiency, Step-Down Converter With DCS-Control™ and Snooze Mode

### 1 Features

- DCS-Control™ Architecture for Fast Transient Regulation
- Snooze Mode for 6.5- $\mu$ A Ultra Low Quiescent Current
- 2.3-V to 6-V Input Voltage Range
- 100% Duty Cycle for Lowest Dropout
- Power Save Mode for Light-Load Efficiency
- Output Discharge Function
- Short-Circuit Protection
- Power-Good Output
- Thermal Shutdown
- Available in 2-mm  $\times$  2-mm 8-Pin WSON Package

### 2 Applications

- Battery-Powered Portable Devices
- Point of Load Regulators
- System Power Rail Voltage Conversion

### 3 Description

The TPS6208x devices are a family of high frequency synchronous step down converters. With an input voltage range of 2.3 V to 6 V, common battery technologies are supported. Alternatively, the device can be used for low voltage system power rails.

The TPS6208x focuses on high efficiency step-down conversion over a wide output current range. At medium to heavy loads, the converter operates in PWM mode and automatically enters Power Save Mode operation at light load currents to maintain high efficiency over the entire load current range. To maintain high efficiency at very low load or no load currents, a Snooze Mode with an ultra-low quiescent current is implemented. This function, enabled by the MODE pin, increases the run-time of battery driven applications and keeps the standby current at its lowest level to meet green energy standards targeting a low stand-by current.

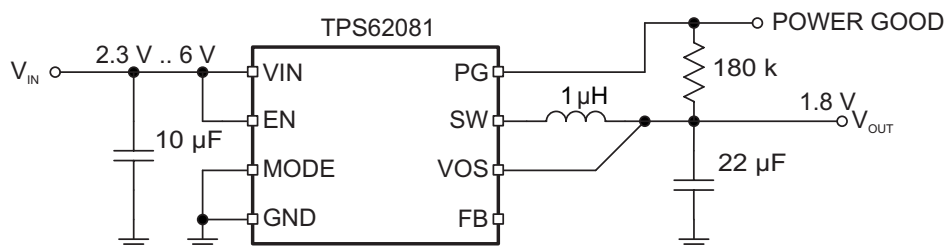
To address the requirements of system power rails, the internal loop compensation allows a large selection of external output capacitor values in excess of 100  $\mu$ F. With its DCS-Control™ architecture, excellent load transient performance and output voltage regulation accuracy is achieved. The device is available in 2-mm  $\times$  2-mm WSON package with Thermal PAD.

#### Device Information<sup>(1)</sup>

PART NUMBER	PACKAGE	BODY SIZE (NOM)
TPS62080	WSON (8)	2.00 mm $\times$ 2.00 mm
TPS62080A		
TPS62081		
TPS62082		

(1) For all available packages, see the orderable addendum at the end of the data sheet.

#### Typical Application Schematic



Copyright © 2016, Texas Instruments Incorporated



## Table of Contents

<b>1 Features</b> .....	<b>1</b>	<b>9 Application and Implementation</b> .....	<b>12</b>
<b>2 Applications</b> .....	<b>1</b>	9.1 Application Information.....	12
<b>3 Description</b> .....	<b>1</b>	9.2 Typical Application .....	12
<b>4 Revision History</b> .....	<b>2</b>	<b>10 Power Supply Recommendations</b> .....	<b>19</b>
<b>5 Device Comparison Table</b> .....	<b>4</b>	<b>11 Layout</b> .....	<b>19</b>
<b>6 Pin Configuration and Functions</b> .....	<b>4</b>	11.1 Layout Guidelines .....	19
<b>7 Specifications</b> .....	<b>5</b>	11.2 Layout Example .....	19
7.1 Absolute Maximum Ratings .....	5	11.3 Thermal Considerations .....	19
7.2 ESD Ratings.....	5	<b>12 Device and Documentation Support</b> .....	<b>20</b>
7.3 Recommended Operating Conditions.....	5	12.1 Device Support.....	20
7.4 Thermal Information .....	5	12.2 Documentation Support .....	20
7.5 Electrical Characteristics.....	6	12.3 Related Links .....	20
7.6 Typical Characteristics .....	7	12.4 Receiving Notification of Documentation Updates	20
<b>8 Detailed Description</b> .....	<b>8</b>	12.5 Community Resources.....	20
8.1 Overview .....	8	12.6 Trademarks .....	20
8.2 Functional Block Diagrams .....	8	12.7 Electrostatic Discharge Caution.....	20
8.3 Feature Description.....	9	12.8 Glossary .....	21
8.4 Device Functional Modes.....	11	<b>13 Mechanical, Packaging, and Orderable Information</b> .....	<b>21</b>

## 4 Revision History

NOTE: Page numbers for previous revisions may differ from page numbers in the current version.

<b>Changes from Revision E (April 2015) to Revision F</b>	<b>Page</b>
• Changed From: $T_A = -40^{\circ}\text{C}$ to $85^{\circ}\text{C}$ To: $T_J = -40^{\circ}\text{C}$ to $125^{\circ}\text{C}$ in the <i>Electrical Characteristics</i> condition statement .....	6
• Added a Test Condition to $I_{SD}$ in the <i>Electrical Characteristics</i> .....	6
• Changed the $R_{DS(on)}$ High-side TYP value From: 120 m $\Omega$ To: 95 m $\Omega$ in the <i>Electrical Characteristics</i> .....	6
• Changed the $R_{DS(on)}$ Low-side TYP value From: 90 m $\Omega$ To: 70 m $\Omega$ in the <i>Electrical Characteristics</i> .....	6
• Changed the graphs to include a 125 $^{\circ}\text{C}$ curve in the <i>Typical Characteristics</i> .....	7
• Added 50 $\Omega$ value to the Power Good block in <a href="#">Figure 5</a> .....	8
• Added 50 $\Omega$ value to the Power Good block in <a href="#">Figure 6</a> .....	9
• Added <a href="#">Table 1</a> .....	9

<b>Changes from Revision D (July 2013) to Revision E</b>	<b>Page</b>
• Added <i>Pin Configuration and Functions</i> section, <i>ESD Ratings</i> table, <i>Feature Description</i> section, <i>Device Functional Modes</i> , <i>Application and Implementation</i> section, <i>Power Supply Recommendations</i> section, <i>Layout</i> section, <i>Device and Documentation Support</i> section, and <i>Mechanical, Packaging, and Orderable Information</i> section .....	1

<b>Changes from Revision C (May 2013) to Revision D</b>	<b>Page</b>
• Deleted TPS62080ADGN from ORDERING INFORMATION table .....	4
• Deleted TPS62080A column from the <i>Thermal Information</i> table.....	5

<b>Changes from Revision B (March 2012) to Revision C</b>	<b>Page</b>
• Changed the Thermal Information tables values.....	5

**Changes from Revision A (February 2012) to Revision B****Page**

- 
- Changed TPS62080ADSG from Product Preview to Production Data in ORDERING INFORMATION..... 4
- 

**Changes from Original (September 2011) to Revision A****Page**

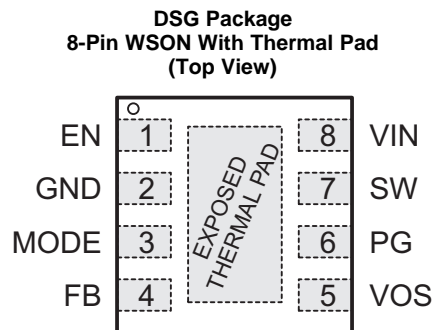
- 
- Added TPS62080A device ..... 1
  - Added TPS62080ADSG (Product Preview) and TPS62080ADGN (Product Preview) to ORDERING INFORMATION ..... 4
  - Added TPS62080A output discharge resistor ..... 6
-

## 5 Device Comparison Table

PART NUMBER <sup>(1)</sup>	OUTPUT VOLTAGE <sup>(2)</sup>	OUTPUT DISCHARGE RESISTOR	PACKAGE MARKING	PACKAGE
TPS62080DSG	Adjustable	1 k $\Omega$	QVR	8-Pin WSON
TPS62081DSG	1.8 V	1 k $\Omega$	QVS	8-Pin WSON
TPS62082DSG	3.3 V	1 k $\Omega$	QVT	8-Pin WSON
TPS62080ADSG	Adjustable	40 $\Omega$	SBN	8-Pin WSON

- (1) For detailed ordering information, see [Mechanical, Packaging, and Orderable Information](#).  
 (2) Contact the factory to check availability of other fixed output voltage versions.

## 6 Pin Configuration and Functions



### Pin Functions

PIN		I/O	DESCRIPTION
NAME	NO.		
EN	1	IN	Device Enable Logic Input. Logic HIGH enables the device, logic LOW disables the device and turns it into shutdown. Do not leave floating.
GND	2	PWR	Power and Signal Ground.
MODE	3	IN	Snooze Mode Enable Logic Input. Logic HIGH enables the Snooze Mode, logic LOW disables the Snooze Mode. Do not leave floating.
FB	4	IN	Feedback Pin for the internal control loop. Connect this pin to the external feedback divider for the adjustable output versions. For the fixed output voltage versions, this pin must be left floating or connected to GND.
VOS	5	IN	Output Voltage Sense Pin for the internal control loop. Must be connected to output voltage.
PG	6	OUT	Power Good open drain output. This pin is pulled to low if the output voltage is below regulation limits. Can be left floating if not used.
SW	7	PWR	Switch Pin connected to the internal MOSFET switches and inductor terminal. Connect the inductor of the output filter here.
VIN	8	PWR	Power Supply Voltage Input.
Exposed Thermal Pad	—	—	Connect it to GND. The thermal pad must be soldered to achieve appropriate power dissipation and mechanical reliability.

## 7 Specifications

### 7.1 Absolute Maximum Ratings

over operating free-air temperature range (unless otherwise noted)<sup>(1)</sup>

	MIN	MAX	UNIT
Voltage at VIN, PG, VOS <sup>(2)</sup>	-0.3	7	V
Voltage at SW <sup>(2)(3)</sup>	-1	7	V
Voltage at FB <sup>(2)</sup>	-0.3	3.6	V
Voltage at EN, MODE <sup>(2)</sup>	-0.3	VIN + 0.3	V
Sink current at PG	0	0.5	mA
Operating junction temperature, T <sub>J</sub>	-40	150	°C
Storage temperature, T <sub>stg</sub>	-65	150	°C

- (1) Stresses beyond those listed under *Absolute Maximum Ratings* may cause permanent damage to the device. These are stress ratings only and functional operation of the device at these or any other conditions beyond those indicated under *Recommended Operating Conditions* is not implied. Exposure to absolute-maximum-rated conditions for extended periods may affect device reliability.
- (2) All voltage values are with respect to network ground terminal.
- (3) During operation, device switching.

### 7.2 ESD Ratings

		VALUE	UNIT
V <sub>(ESD)</sub> Electrostatic discharge	Human body model (HBM), per ANSI/ESDA/JEDEC JS-001 <sup>(1)</sup>	±2000	V
	Charged-device model (CDM), per JEDEC specification JESD22-C101 <sup>(2)</sup>	±500	

- (1) JEDEC document JEP155 states that 500-V HBM allows safe manufacturing with a standard ESD control process.
- (2) JEDEC document JEP157 states that 250-V CDM allows safe manufacturing with a standard ESD control process.

### 7.3 Recommended Operating Conditions<sup>(1)</sup>

		MIN	NOM	MAX	UNIT
V <sub>IN</sub>	Input voltage	2.3		6	V
V <sub>OUT</sub>	Output voltage	0.5		4	V
I <sub>SNOOZE</sub>	Load current in Snooze Mode			2	mA
T <sub>J</sub>	Operating junction temperature	-40		125	°C

- (1) Refer to the [Application and Implementation](#) section for further information.

### 7.4 Thermal Information

THERMAL METRIC <sup>(1)</sup>		TPS6208x	UNIT
		DSG (WSON)	
		8 PINS	
R <sub>θJA</sub>	Junction-to-ambient thermal resistance	59.7	°C/W
R <sub>θJC(top)</sub>	Junction-to-case (top) thermal resistance	70.1	
R <sub>θJB</sub>	Junction-to-board thermal resistance	30.9	
ψ <sub>JT</sub>	Junction-to-top characterization parameter	1.4	
ψ <sub>JB</sub>	Junction-to-board characterization parameter	31.5	
R <sub>θJC(bot)</sub>	Junction-to-case (bottom) thermal resistance	8.6	

- (1) For more information about traditional and new thermal metrics, see the [Semiconductor and IC Package Thermal Metrics](#) application report.

## 7.5 Electrical Characteristics

Over recommended free-air temperature range,  $T_J = -40^{\circ}\text{C}$  to  $125^{\circ}\text{C}$ . Typical values are at  $T_A = 25^{\circ}\text{C}$  (unless otherwise noted),  $V_{IN} = 3.6\text{ V}$ ,  $\text{MODE} = \text{LOW}$ .

PARAMETER		TEST CONDITIONS	MIN	TYP	MAX	UNIT
<b>SUPPLY</b>						
$V_{IN}$	Input voltage range		2.3		6	V
$I_Q$	Quiescent current into $V_{IN}$	$I_{OUT} = 0\text{ mA}$ , Device not switching		30		$\mu\text{A}$
	Quiescent current into $V_{IN}$ (SNOOZE MODE)	$I_{OUT} = 0\text{ mA}$ , Device not switching, $\text{MODE} = \text{HIGH}$		6.5		$\mu\text{A}$
$I_{SD}$	Shutdown current into $V_{IN}$	EN = LOW $T_A = -40^{\circ}\text{C}$ to $85^{\circ}\text{C}$			7	$\mu\text{A}$
					1	
$V_{UVLO}$	Undervoltage lockout	Input voltage falling		1.8	2	V
	Undervoltage lockout hysteresis	Rising above $V_{UVLO}$		120		mV
$T_{JSD}$	Thermal shutdown	Temperature rising		150		$^{\circ}\text{C}$
	Thermal shutdown hysteresis	Temperature falling below $T_{JSD}$		20		$^{\circ}\text{C}$
<b>LOGIC INTERFACE (EN MODE)</b>						
$V_{IH}$	High level input voltage	$2.3\text{ V} \leq V_{IN} \leq 6\text{ V}$	1			V
$V_{IL}$	Low level input voltage	$2.3\text{ V} \leq V_{IN} \leq 6\text{ V}$			0.4	V
$I_{LKG}$	Input leakage current			0.01	0.5	$\mu\text{A}$
<b>POWER GOOD</b>						
$V_{PG}$	Power good threshold	$V_{OUT}$ falling referenced to $V_{OUT}$ nominal	-15%	-10%	-5%	
	Power good hysteresis			5%		
$V_{OL}$	Low level voltage	$I_{sink} = 500\text{ }\mu\text{A}$			0.3	V
$I_{PG,LKG}$	PG Leakage current	$V_{PG} = 5.0\text{ V}$		0.01	0.1	$\mu\text{A}$
<b>OUTPUT</b>						
$V_{OUT}$	Output voltage range TPS62080, TPS62080A		0.5		4.0	V
	Output voltage accuracy TPS62081	$I_{OUT} = 0\text{ mA}$ ; $V_{IN} \geq 2.3\text{ V}$	-2.5%		2.5%	
	Output voltage accuracy TPS62082	$I_{OUT} = 0\text{ mA}$ ; $V_{IN} \geq 3.6\text{ V}$	-2.5%		2.5%	
	Snooze Mode output voltage accuracy	$\text{MODE} = \text{HIGH}$ ; $V_{IN} \geq 2.3\text{ V}$ and $V_{IN} \geq V_{OUT} + 1\text{ V}$	-5%		5%	
$V_{FB}$	Feedback regulation voltage TPS62080, TPS62080A	$V_{IN} \geq 2.3\text{ V}$ and $V_{IN} \geq V_{OUT} + 1\text{ V}$	0.438	0.45	0.462	V
$I_{FB}$	Feedback input bias current TPS62080, TPS62080A	$V_{FB} = 0.45\text{ V}$		10	100	nA
$R_{DIS}$	Output discharge resistor	EN = LOW, $V_{OUT} = 1.8\text{ V}$		1		k $\Omega$
		TPS62080A, EN = LOW, $V_{OUT} = 1.2\text{ V}$	25	40	65	$\Omega$
	Line Regulation			0		%/V
	Load Regulation	TPS62081, TPS62082		-0.25		%/A
$R_{DS(on)}$	High-side FET ON-resistance	$I_{SW} = 500\text{ mA}$		95		m $\Omega$
	Low-side FET ON-resistance	$I_{SW} = 500\text{ mA}$		70		m $\Omega$
$I_{LIM}$	High-side FET switch current limit	Rising inductor current	1.6	2.8	4	A

## 7.6 Typical Characteristics

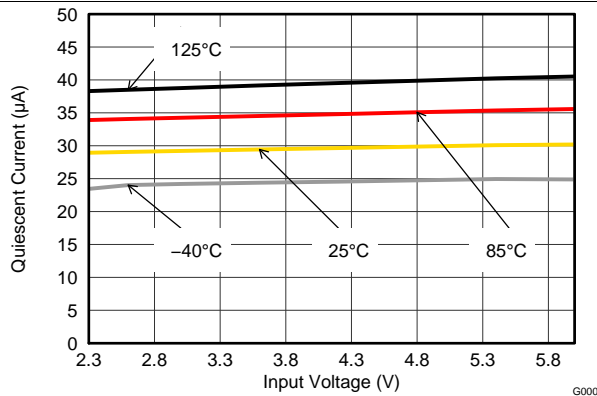


Figure 1. Quiescent Current vs Input Voltage in Normal Mode

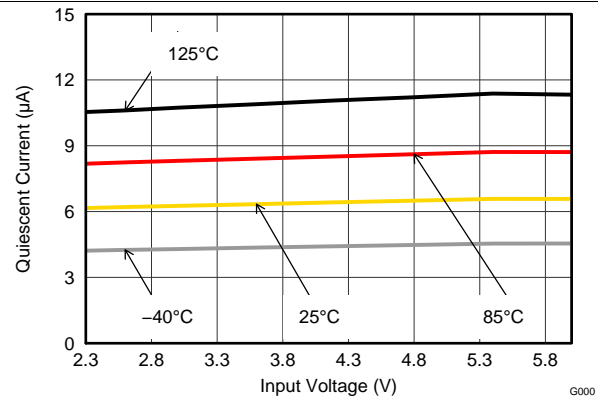


Figure 2. Quiescent Current vs Input Voltage in Snooze Mode

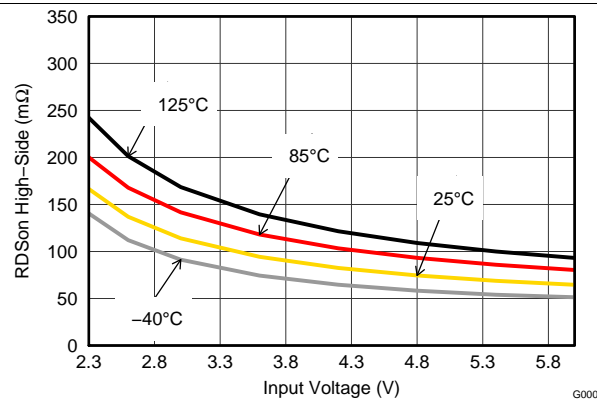


Figure 3. High-Side FET  $R_{DS(on)}$  vs Input Voltage

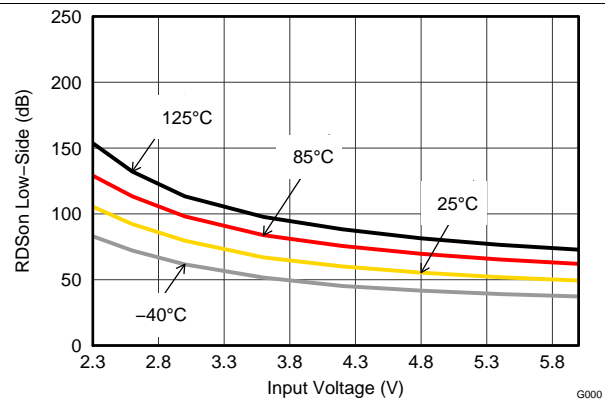


Figure 4. Low-Side FET  $R_{DS(on)}$  vs Input Voltage

## 8 Detailed Description

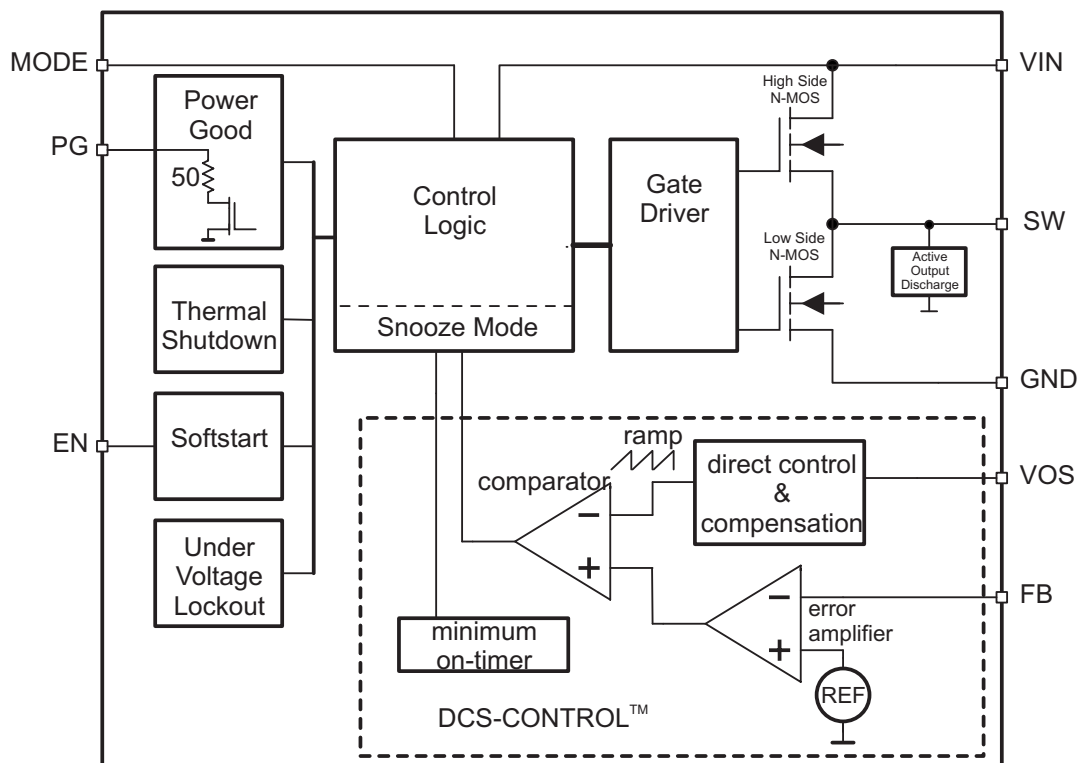
### 8.1 Overview

The TPS6208x synchronous switched mode converters are based on DCS-Control™ (Direct Control with Seamless transition into Power Save Mode). This is an advanced regulation topology that combines the advantages of hysteretic, voltage and current mode control.

The DCS-Control topology operates in pulse width modulation (PWM) mode for medium to heavy load conditions and in Power Save Mode at light load currents. In PWM mode, the converter operates with its nominal switching frequency of 2 MHz having a controlled frequency variation over the input voltage range. As the load current decreases, the converter enters Power Save Mode, reducing the switching frequency and minimizing the IC quiescent current to achieve high efficiency over the entire load current range. DCS-Control supports both operation modes (PWM and PFM) using a single building block having a seamless transition from PWM to Power Save Mode without effects on the output voltage. Fixed output voltage versions provide smallest solution size combined with lowest no load current consumption. The TPS6208x offers both excellent DC voltage and superior load transient regulation, combined with very low output voltage ripple, minimizing interference with RF circuits.

The device is equipped with Snooze Mode functionality, which is enabled with the MODE pin. Snooze Mode supports high efficiency conversion at lowest output currents below 2 mA. If no load current is drawn, the ultra low quiescent current of 6.5  $\mu\text{A}$  is sufficient to maintain the output voltage. This extends battery run time by reducing the quiescent current during lowest or no load conditions in battery-driven applications. For mains-operated voltage supplies, Snooze Mode reduces the system's stand-by energy consumption. During shutdown (EN = LOW), the device reduces energy consumption to less than 1  $\mu\text{A}$ .

### 8.2 Functional Block Diagrams

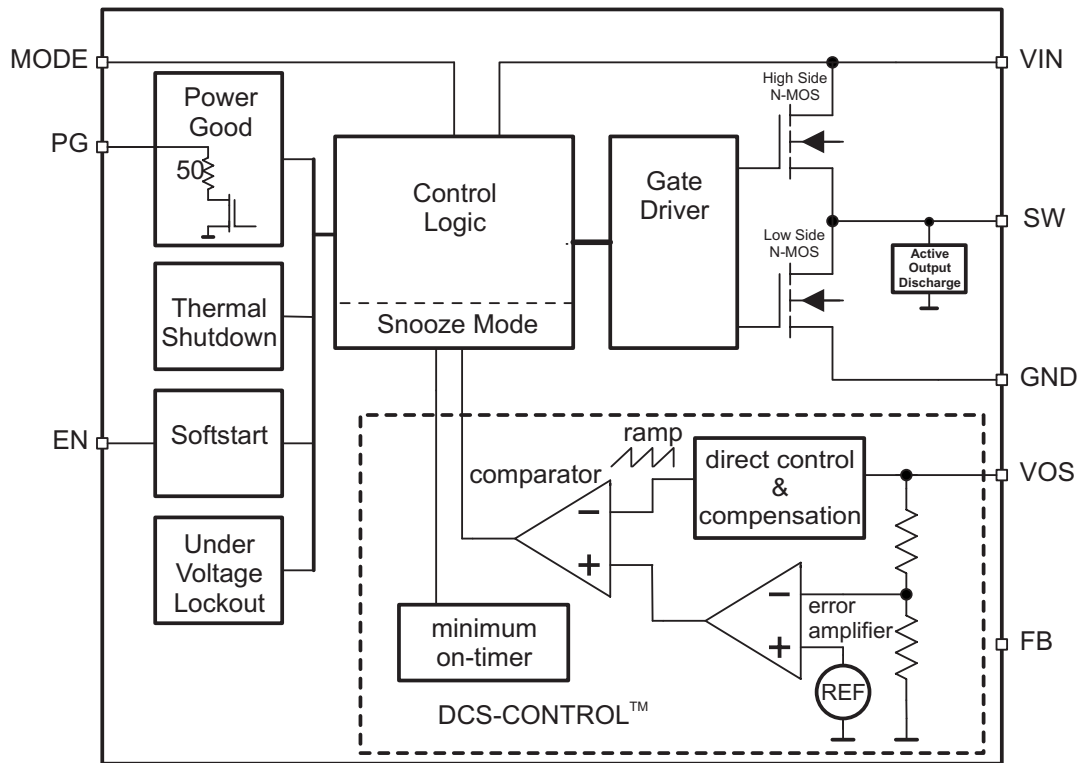


Copyright © 2016, Texas Instruments Incorporated

**Figure 5. Functional Block Diagram (Adjustable Output Voltage Version)**



Functional Block Diagrams (continued)



Copyright © 2016, Texas Instruments Incorporated

Figure 6. Functional Block Diagram (Fixed Output Voltage Version)

8.3 Feature Description

8.3.1 Power Good

The TPS6208x has a power good output which goes low when the output voltage is below its nominal value. The power good is high impedance once the output is above 95% of the regulated voltage, and is driven to low once the output voltage falls below typically 90% of the regulated voltage. The PG pin is an open drain output and can sink up to 0.5 mA. The power good output requires a pull-up resistor. When the device is off due to disable, UVLO or thermal shutdown, the PG pin is high impedance (see Table 1). The PG signal can be used for sequencing of multiple rails by connecting to the EN pin of other converters. Leave the PG pin unconnected when not used.

Table 1. Power Good Pin Logic Table

Device Information		PG Logic Status	
		High Z	Low
Enable (EN=High)	$V_{FB} \geq V_{PG}$	√	
	$V_{FB} \leq V_{PG}$		√
Shutdown (EN=Low)		√	
UVLO	$0.7V < V_{IN} < V_{UVLO}$	√	
Thermal Shutdown	$T_J > T_{JSD}$	√	
Power Supply Removal	$V_{IN} < 0.7V$	√	

### 8.3.2 100% Duty Cycle Low Dropout Operation

The device offers low input to output voltage difference by entering 100% duty cycle mode. In this mode, the high-side MOSFET switch is constantly turned on and the low-side MOSFET is switched off. This is particularly useful in battery powered applications to achieve longest operation time by taking full advantage of the whole battery voltage range. The minimum input voltage to maintain an output voltage is calculated as:

$$V_{IN,MIN} = V_{OUT} + I_{OUT,MAX} \times (R_{DS(on)} + R_L)$$

where

- $V_{IN,MIN}$  = Minimum input voltage
- $I_{OUT,MAX}$  = Maximum output current
- $R_{DS(on)}$  = High-side FET ON-resistance
- $R_L$  = Inductor ohmic resistance

(1)

### 8.3.3 Output Discharge

The output gets discharged by the SW pin with a typical discharge resistor of  $R_{DIS}$  whenever the device shuts down. This is the case when the device gets disabled by enable, thermal shutdown, or undervoltage lockout. The TPS6208A differs from the TPS62080 only in its stronger discharge.

### 8.3.4 Soft-Start

When EN is set to start device operation, the device starts switching after a delay of about 40  $\mu$ s and VOUT rises with a slope of about 10mV/ $\mu$ s (See [Figure 27](#) and [Figure 29](#) for typical startup operation). This avoids excessive inrush current and creates a smooth output voltage rise slope. It also prevents excessive voltage drops of primary cells and rechargeable batteries with high internal impedance.

If the output voltage is not reached within the soft start time, such as in the case of heavy load, the converter enters regular operation. Consequently, the inductor current limit operates as described below. The TPS6208x is able to start into a pre-biased output capacitor. The converter starts with the applied bias voltage and ramps up the output voltage to its nominal value.

### 8.3.5 Undervoltage Lockout

To avoid mis-operation of the device at low input voltages, an undervoltage lockout is implemented that shuts down the device at voltages lower than  $V_{UVLO}$  with a 120 mV typical hysteresis.

### 8.3.6 Thermal Shutdown

The device goes into thermal shutdown once the junction temperature exceeds typically  $T_{JSD}$ . Once the device temperature falls below the threshold minus hysteresis, the device returns to normal operation automatically.

### 8.3.7 Inductor Current Limit

The Inductor Current Limit prevents the device from high inductor current and drawing excessive current from the battery or input voltage rail. Excessive current might occur with a shorted/saturated inductor or a heavy load/shorted output circuit condition.

The incorporated inductor peak current limit measures the current in the high-side and low-side power MOSFET. Once the high-side switch current limit is tripped, the high-side MOSFET is turned off and the low-side MOSFET is turned on to reduce the inductor current. When the inductor current drops down to the low-side switch current limit, the low-side MOSFET is turned off and the high-side switch is turned on again. This operation repeats until the inductor current does not reach the high-side switch current limit. Due to internal propagation delays, the real current limit value can exceed the static current limit in [Electrical Characteristics](#).

## 8.4 Device Functional Modes

### 8.4.1 Enabling and Disabling the Device

The device is enabled by setting the EN input to a logic HIGH. Accordingly, a logic LOW disables the device. If the device is enabled, the internal power stage starts switching and regulates the output voltage to the programmed threshold. The EN input must be terminated and not left floating.

### 8.4.2 Power Save Mode

As the load current decreases, the TPS6208x enters Power Save Mode operation. During Power Save Mode, the converter operates with reduced switching frequency in PFM mode and with a minimum quiescent current maintaining high efficiency. Power Save Mode occurs when the inductor current becomes discontinuous. It is based on a fixed on time architecture. The typical on time is given by  $t_{on} = 500 \text{ ns} \times (V_{OUT}/V_{IN})$ . The switching frequency over the whole load current range is shown in [Figure 21](#) and [Figure 22](#).

### 8.4.3 Snooze Mode

The TPS6208x offers a Snooze Mode function. If Snooze Mode is enabled by an external logic signal setting the MODE pin to HIGH, the device's quiescent current consumption is reduced to typically 6.5  $\mu\text{A}$ . As a result, the high efficiency range is extended towards the range of lowest output currents below 2 mA. See the efficiency figures in [Application Curves](#).

If the device is operating in Snooze Mode, a dedicated, low power consuming block monitors the output voltage. All other control blocks are snoozing during that time. If the output voltage falls below the programmed output voltage by 3.5% (typ), the control blocks wake up, regulate the output voltage and allow themselves to snooze again until the output voltage drops again. Snooze Mode operation provides a clear efficiency improvement at lowest output currents. If the load current increases, the advantage of efficiency in Snooze mode is reduced. Because the dynamic load regulation operates best if Snooze Mode is disabled, it is recommended to turn off Snooze Mode when the load current exceeds 2 mA. Generally, a microcontroller operates the MODE pin.

## 9 Application and Implementation

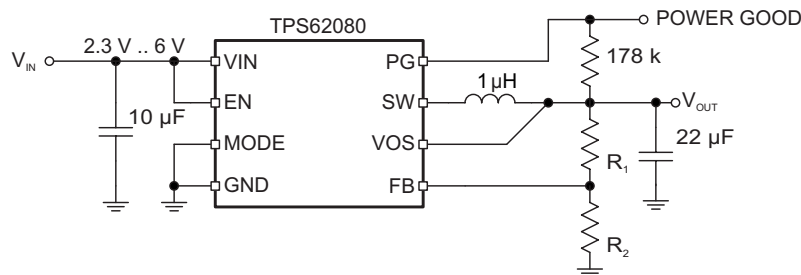
### NOTE

Information in the following applications sections is not part of the TI component specification, and TI does not warrant its accuracy or completeness. TI's customers are responsible for determining suitability of components for their purposes. Customers should validate and test their design implementation to confirm system functionality.

### 9.1 Application Information

The TPS62080 and TPS62080A are synchronous step-down converter whose output voltage is adjusted by component selection. The following section discusses the design of the external components to complete the power supply design for several input and output voltage options by using typical applications as a reference. The TPS62081 and TPS62082 provide a fixed output voltage which do not need an external resistor divider.

### 9.2 Typical Application



Copyright © 2016, Texas Instruments Incorporated

**Figure 7. Typical Application Schematic**

#### 9.2.1 Design Requirements

For this design example, use [Table 2](#) as the input parameters.

**Table 2. Design Parameters**

DESIGN PARAMETER	EXAMPLE VALUE
Input voltage	2.3 V to 6 V
Output voltage	1.2 V
Output ripple voltage	< 20 mV
Maximum output current	1.2 A

#### 9.2.2 Detailed Design Procedure

[Table 3](#) lists the components used for the example.

**Table 3. List of Components**

REFERENCE	DESCRIPTION	MANUFACTURER
C1	10 uF, Ceramic Capacitor, 6.3 V, X5R, size 0603	Std
C2	22 uF, Ceramic Capacitor, 6.3 V, X5R, size 0805, GRM21BR60J226ME39L	Murata
L1	1.0 µH, Power Inductor, 2.2 A, size 3 × 3 × 1.2 mm, XFL3012-102MEB	Coilcraft
R1	Depending on the output voltage of TPS62080, 1%; Not populated for TPS62081, TPS62082;	Std
R2	39.2k, Chip Resistor, 1/16W, 1%, size 0603	Std
R3	178k, Chip Resistor, 1/16W, 1%, size 0603	Std

### 9.2.2.1 Setting the Output Voltage

The TPS608x devices are available as fixed and adjustable output voltage versions. The fixed voltage versions are internally programmed to a fixed output voltage, whereas the adjustable output voltage version needs to be programmed via an external voltage divider to set the desired output voltage.

#### 9.2.2.1.1 Adjustable Output Voltage Version

For the adjustable output voltage version, an external resistor divider is used. By selecting  $R_1$  and  $R_2$ , the output voltage is programmed to the desired value.

When the output voltage is regulated, the typical voltage at the FB pin is  $V_{FB}$  for the adjustable devices. The following equation can be used to calculate  $R_1$  and  $R_2$ .

$$V_{OUT} = V_{FB} \times \left(1 + \frac{R_1}{R_2}\right) = 0.45V \times \left(1 + \frac{R_1}{R_2}\right) \quad (2)$$

For best accuracy,  $R_2$  should be kept smaller than  $40k\Omega$  to ensure that the current flowing through  $R_2$  is at least 100 times larger than  $I_{FB}$ . Changing towards a lower value increases the robustness against noise injection. Changing towards higher values reduces the input current. For lowest input current during Snooze Mode, it is recommended to use a fixed output voltage version such as TPS62081 and TPS62082.

#### 9.2.2.2 Output Filter Design

The inductor and the output capacitor together provide a low pass filter. To simplify this process, [Table 4](#) outlines possible inductor and capacitor value combinations for most applications. Checked cells represent combinations that are proven for stability by simulation and lab test. Further combinations should be checked for each individual application.

**Table 4. Matrix of Output Capacitor and Inductor Combinations**

L [ $\mu$ H] <sup>(1)</sup>	C <sub>OUT</sub> [ $\mu$ F] <sup>(1)</sup>				
	10	22	47	100	150
0.47					
1	+	+(2)(3)	+	+	
2.2	+	+	+	+	
4.7					

- (1) Capacitance tolerance and bias voltage de-rating is anticipated. The effective capacitance can vary by +20% and –50%. Inductor tolerance and current de-rating is anticipated. The effective inductance can vary by +20% and –30%.
- (2) Plus mark indicates recommended filter combinations.
- (3) Filter combination in typical application.

#### 9.2.2.3 Inductor Selection

The main parameters for the inductor selection are the inductor value and then the saturation current of the inductor. To calculate the maximum inductor current under static load conditions, [Equation 3](#) is given.

$$I_{L,MAX} = I_{OUT,MAX} + \frac{\Delta I_L}{2}$$

$$\Delta I_L = V_{OUT} \times \frac{1 - \frac{V_{OUT}}{V_{IN}}}{L \times f_{SW}}$$

where

- $I_{OUT,MAX}$  = Maximum output current
- $\Delta I_L$  = Inductor current ripple
- $f_{SW}$  = Switching frequency
- $L$  = Inductor value

(3)

TI recommends to choose the saturation current for the inductor 20%–30% higher than the  $I_{L,MAX}$ , out of [Equation 3](#). A higher inductor value is also useful to lower ripple current, but increases the transient response time as well. The following inductors are recommended for use.

**Table 5. List of Recommended Inductors**

INDUCTANCE [ $\mu$ H]	CURRENT RATING [mA]	DIMENSIONS L x W x H [mm <sup>3</sup> ]	DC RESISTANCE [m $\Omega$ typ]	TYPE	MANUFACTURER
1.0	2500	3 x 3 x 1.2	35	XFL3012-102ME	Coilcraft
1.0	1650	3 x 3 x 1.2	40	LQH3NPN1R0NJ0	Murata
2.2	2500	4 x 3.7 x 1.65	49	LQH44PN2R2MP0	Murata
2.2	1600	3 x 3 x 1.2	81	XFL3012-222ME	Coilcraft

#### 9.2.2.4 Capacitor Selection

The input capacitor is the low impedance energy source for the converter which helps to provide stable operation. A low ESR multilayer ceramic capacitor is recommended for best filtering and should be placed between VIN and GND as close as possible to those pins. For most applications 10  $\mu$ F is sufficient, though a larger value reduces input current ripple.

The architecture of the TPS6208X allows the use of tiny ceramic output capacitors with low equivalent series resistance (ESR). These capacitors provide low output voltage ripple and are recommended. To keep its resistance up to high frequencies and to get narrow capacitance variation with temperature, it's recommended to use X7R or X5R dielectric. The TPS6208x is designed to operate with an output capacitance of 10  $\mu$ F to 100  $\mu$ F and beyond, as outlined in [Table 4](#). Load transient testing and measuring the bode plot are good ways to verify stability with larger capacitor values.

**Table 6. List of Recommended Capacitors**

CAPACITANCE [ $\mu$ F]	TYPE	DIMENSIONS L x W x H [mm <sup>3</sup> ]	MANUFACTURER
10	GRM188R60J106M	0603: 1.6 x 0.8 x 0.8	Murata
22	GRM188R60G226M	0603: 1.6 x 0.8 x 0.8	Murata
22	GRM21BR60J226M	0805: 2.0 x 1.2 x 1.25	Murata

### 9.2.3 Application Curves

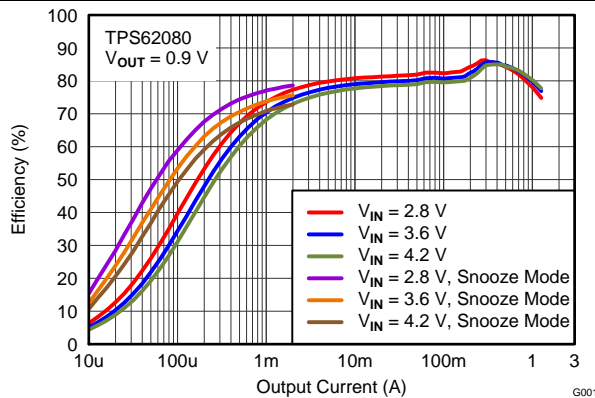


Figure 8. Efficiency vs Load Current

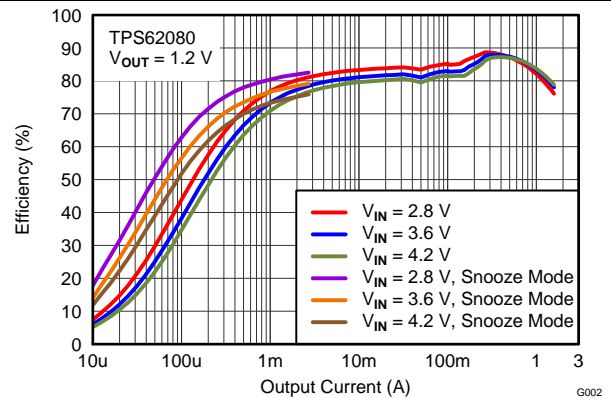


Figure 9. Efficiency vs Load Current

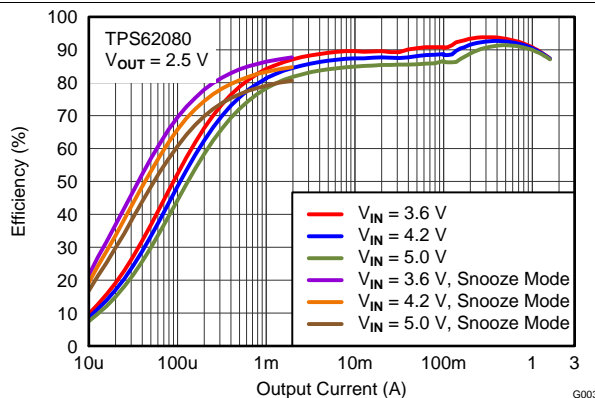


Figure 10. Efficiency vs Load Current

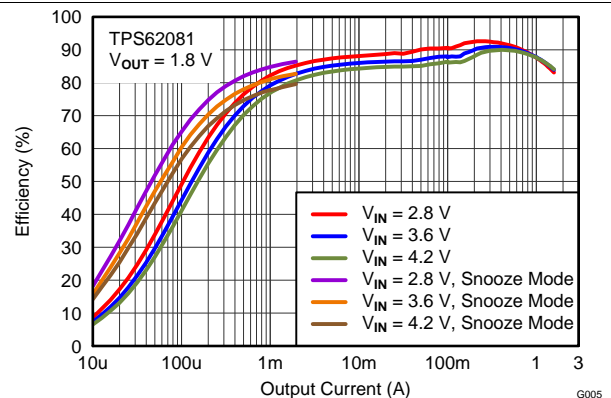


Figure 11. Efficiency vs Load Current

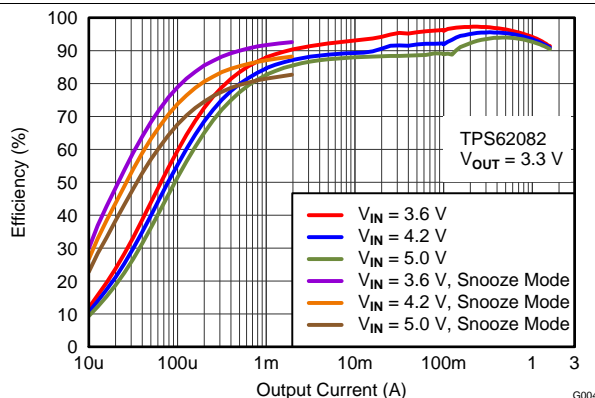


Figure 12. Efficiency vs Load Current

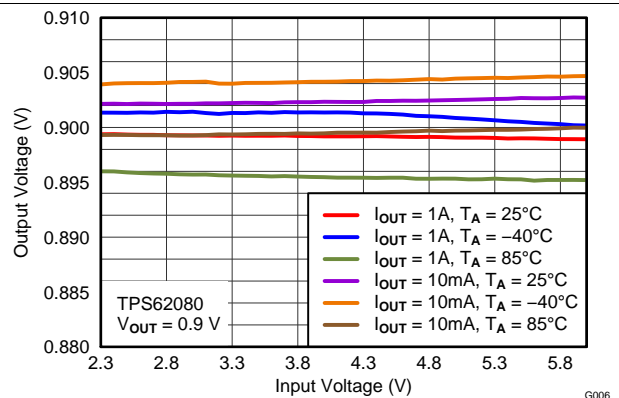


Figure 13. Output Voltage vs Input Voltage

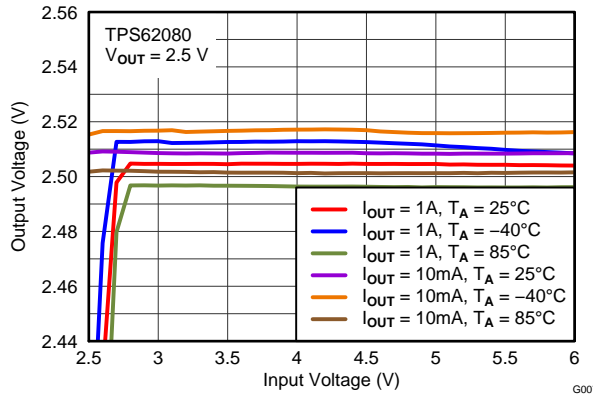


Figure 14. Output Voltage vs Input Voltage

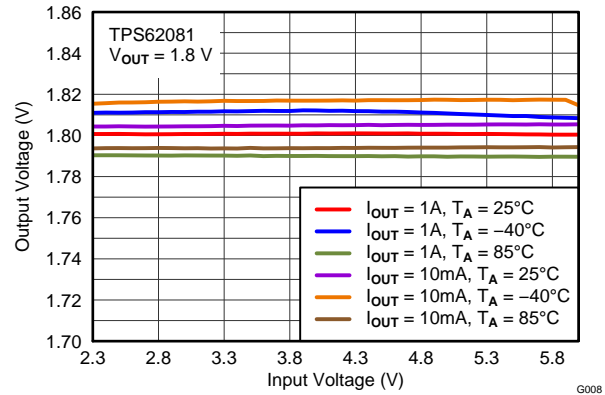


Figure 15. Output Voltage vs Input Voltage

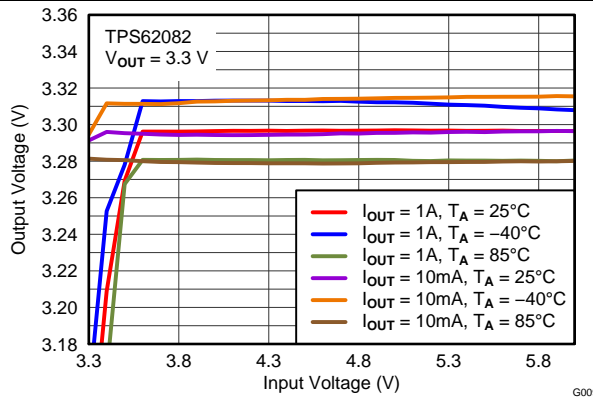


Figure 16. Output Voltage vs Input Voltage

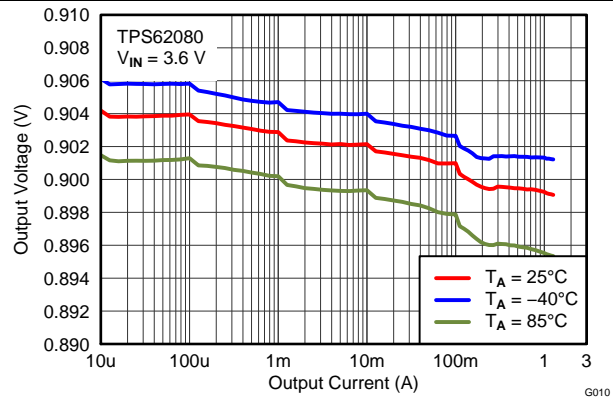


Figure 17. Output Voltage vs Load Current

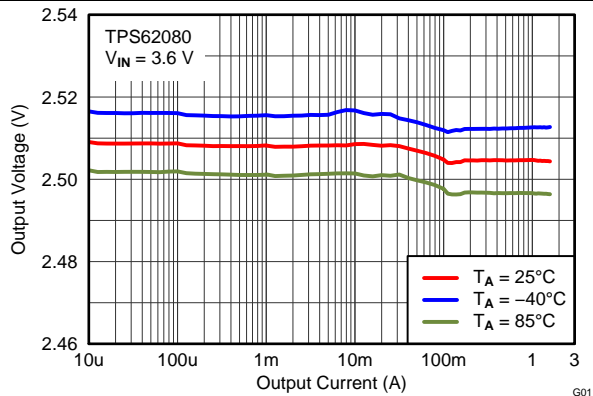


Figure 18. Output Voltage vs Load Current

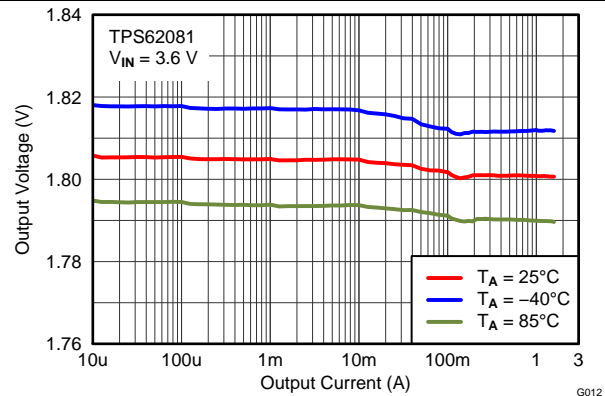
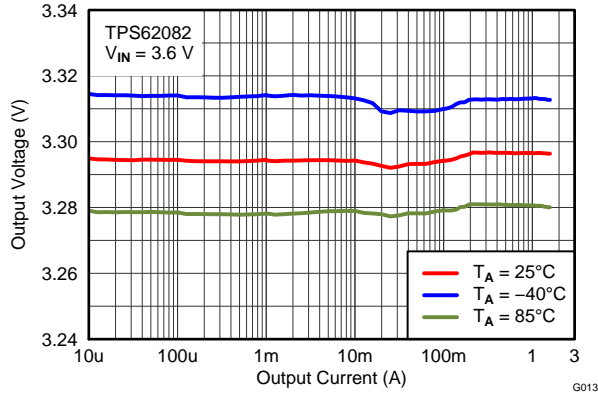
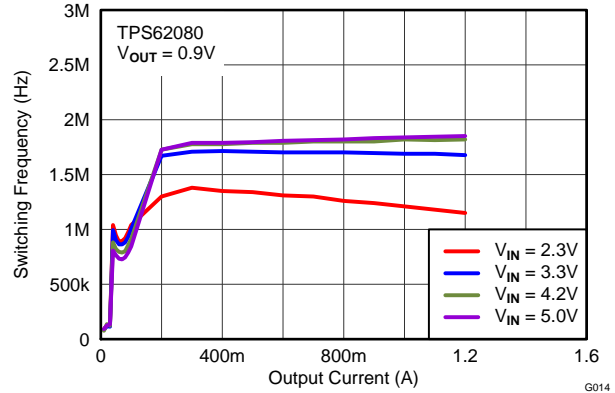


Figure 19. Output Voltage vs Load Current

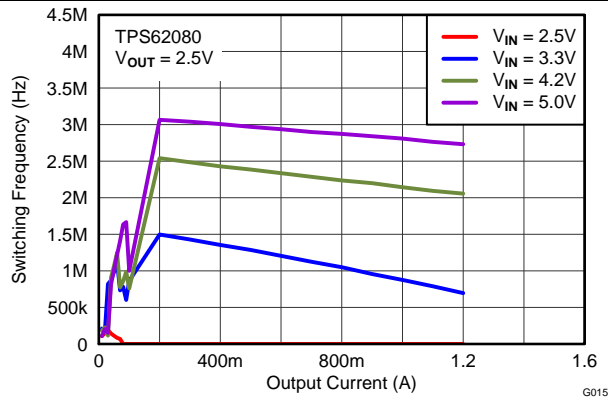




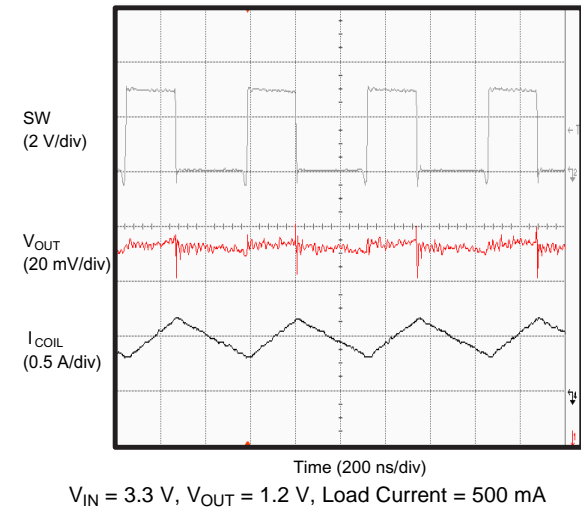
**Figure 20. Output Voltage vs Load Current**



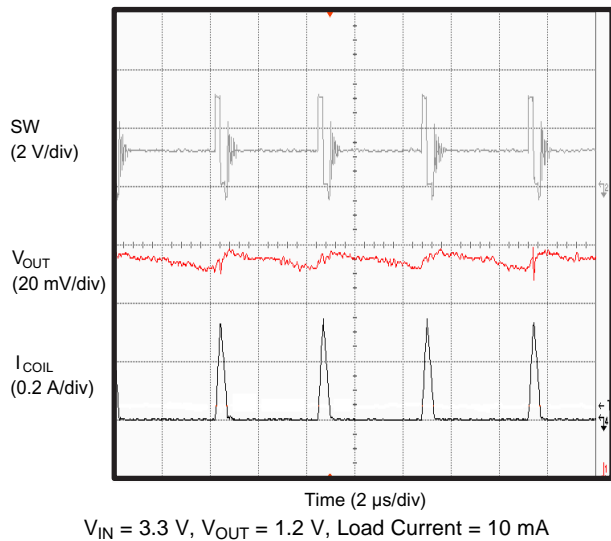
**Figure 21. Switching Frequency vs Load Current**



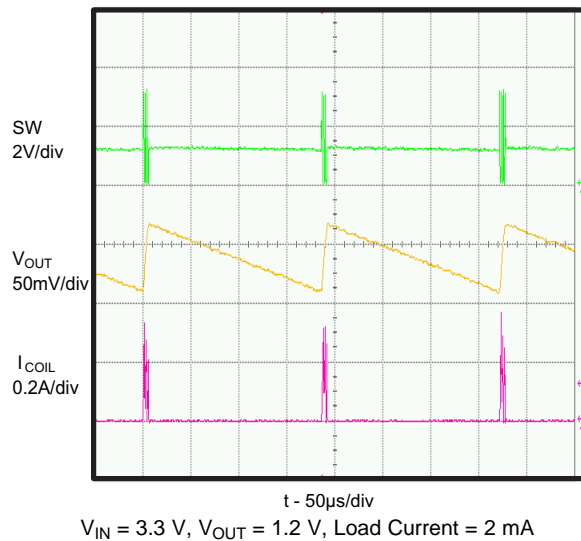
**Figure 22. Switching Frequency vs Load Current**



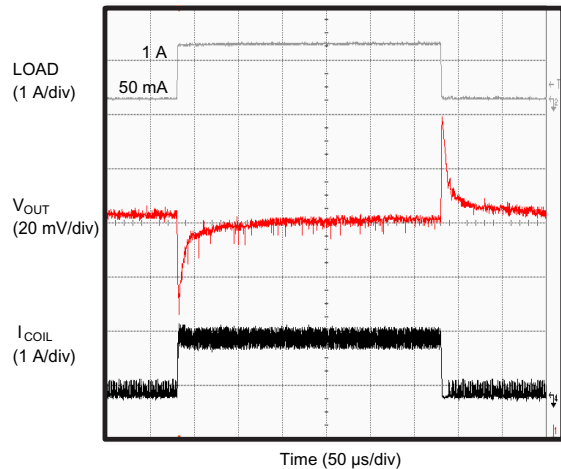
**Figure 23. Typical Application (PWM Mode)**



**Figure 24. Typical Application (PFM Mode)**

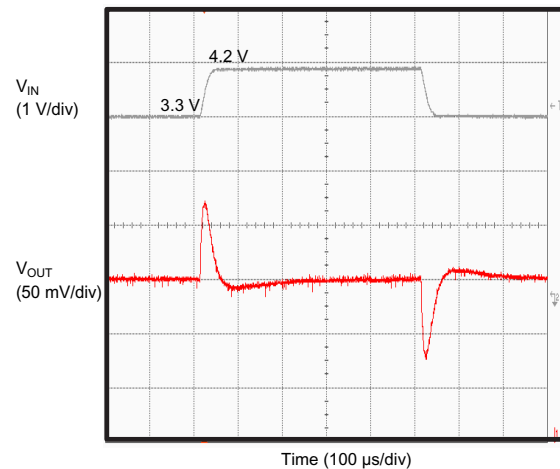


**Figure 25. Typical Application (Snooze Mode)**



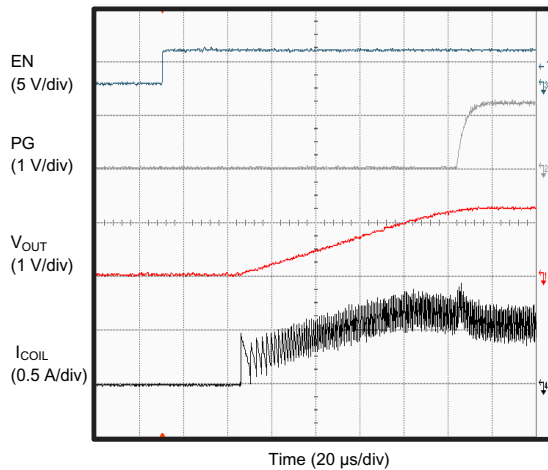
$V_{IN} = 3.3\text{ V}$ ,  $V_{OUT} = 1.2\text{ V}$ , Load Current = 50 mA to 1 A

**Figure 26. Load Transient**



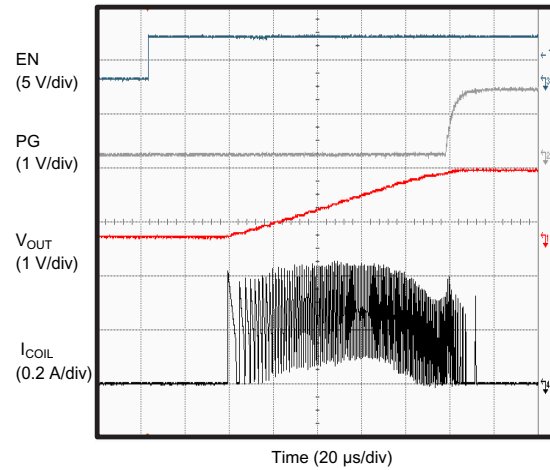
$V_{IN} = 3.3\text{ V}$  to  $4.2\text{ V}$ ,  $V_{OUT} = 1.2\text{ V}$ , Load =  $2.2\ \Omega$

**Figure 27. Line Transient**



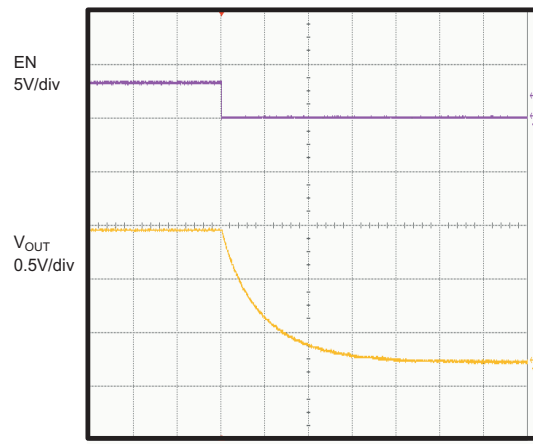
$V_{IN} = 3.3\text{ V}$ ,  $V_{OUT} = 1.2\text{ V}$ , Load =  $2.2\ \Omega$

**Figure 28. Start Up**



$V_{IN} = 3.3\text{ V}$ ,  $V_{OUT} = 1.2\text{ V}$ , No Load

**Figure 29. Start Up (Without Load)**



$V_{IN} = 3.3\text{ V}$ ,  $V_{OUT} = 1.2\text{ V}$ , No Load

**Figure 30. Shutdown**

## 10 Power Supply Recommendations

The device is designed to operate from an input supply voltage range between 2.3 V and 6 V. Ensure that the input power supply has a sufficient current rating for the application.

## 11 Layout

### 11.1 Layout Guidelines

The PCB layout is an important step to maintain the high performance of the TPS6208x devices.

The input/output capacitors and the inductor should be placed as close as possible to the IC. This keeps the traces short. Routing these traces direct and wide results in low trace resistance and low parasitic inductance. A common power GND should be used. The low-side of the input and output capacitors must be connected properly to the power GND to avoid a GND potential shift.

The sense traces connected to the FB and VOS pins are signal traces. Special care should be taken to avoid noise being induced. By a direct routing, parasitic inductance can be kept small. GND layers might be used for shielding. Keep these traces away from SW nodes.

### 11.2 Layout Example

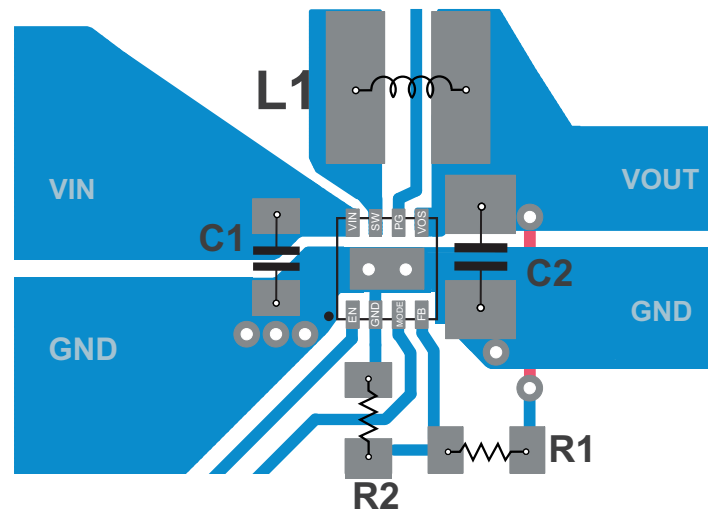


Figure 31. PCB Layout Suggestion

### 11.3 Thermal Considerations

Implementation of integrated circuits in low-profile and fine-pitch surface-mount packages typically requires special attention to power dissipation. Many system-dependent issues such as thermal coupling, airflow, added heat sinks and convection surfaces, and the presence of other heat-generating components affect the power-dissipation limits of a given component.

Three basic approaches for enhancing thermal performance are listed below:

- Improving the power dissipation capability of the PCB design
- Improving the thermal coupling of the component to the PCB by soldering Exposed Thermal Pad
- Introducing airflow in the system

For more details on how to use the thermal parameters, see the application notes: *Thermal Characteristics of Linear and Logic Packages Using JEDEC PCB Designs* (SZZA017) and *Semiconductor and IC Package Thermal Metrics* (SPRA953).

## 12 Device and Documentation Support

### 12.1 Device Support

#### 12.1.1 Third-Party Products Disclaimer

TI'S PUBLICATION OF INFORMATION REGARDING THIRD-PARTY PRODUCTS OR SERVICES DOES NOT CONSTITUTE AN ENDORSEMENT REGARDING THE SUITABILITY OF SUCH PRODUCTS OR SERVICES OR A WARRANTY, REPRESENTATION OR ENDORSEMENT OF SUCH PRODUCTS OR SERVICES, EITHER ALONE OR IN COMBINATION WITH ANY TI PRODUCT OR SERVICE.

### 12.2 Documentation Support

#### 12.2.1 Related Documentation

For related documentation see the following:

*Thermal Characteristics of Linear and Logic Packages Using JEDEC PCB Designs* ([SZZA017](#))

### 12.3 Related Links

The table below lists quick access links. Categories include technical documents, support and community resources, tools and software, and quick access to sample or buy.

**Table 7. Related Links**

PARTS	PRODUCT FOLDER	SAMPLE & BUY	TECHNICAL DOCUMENTS	TOOLS & SOFTWARE	SUPPORT & COMMUNITY
TPS62080	<a href="#">Click here</a>	<a href="#">Click here</a>	<a href="#">Click here</a>	<a href="#">Click here</a>	<a href="#">Click here</a>
TPS62080A	<a href="#">Click here</a>	<a href="#">Click here</a>	<a href="#">Click here</a>	<a href="#">Click here</a>	<a href="#">Click here</a>
TPS62081	<a href="#">Click here</a>	<a href="#">Click here</a>	<a href="#">Click here</a>	<a href="#">Click here</a>	<a href="#">Click here</a>
TPS62082	<a href="#">Click here</a>	<a href="#">Click here</a>	<a href="#">Click here</a>	<a href="#">Click here</a>	<a href="#">Click here</a>

### 12.4 Receiving Notification of Documentation Updates

To receive notification of documentation updates, navigate to the device product folder on ti.com. In the upper right corner, click on *Alert me* to register and receive a weekly digest of any product information that has changed. For change details, review the revision history included in any revised document.

### 12.5 Community Resources

The following links connect to TI community resources. Linked contents are provided "AS IS" by the respective contributors. They do not constitute TI specifications and do not necessarily reflect TI's views; see TI's [Terms of Use](#).

**TI E2E™ Online Community** *TI's Engineer-to-Engineer (E2E) Community*. Created to foster collaboration among engineers. At [e2e.ti.com](http://e2e.ti.com), you can ask questions, share knowledge, explore ideas and help solve problems with fellow engineers.

**Design Support** *TI's Design Support* Quickly find helpful E2E forums along with design support tools and contact information for technical support.

### 12.6 Trademarks

DCS-Control, E2E are trademarks of Texas Instruments.  
All other trademarks are the property of their respective owners.

### 12.7 Electrostatic Discharge Caution



These devices have limited built-in ESD protection. The leads should be shorted together or the device placed in conductive foam during storage or handling to prevent electrostatic damage to the MOS gates.

## 12.8 Glossary

[SLYZ022](#) — *TI Glossary*.

This glossary lists and explains terms, acronyms, and definitions.

## 13 Mechanical, Packaging, and Orderable Information

The following pages include mechanical, packaging, and orderable information. This information is the most current data available for the designated devices. This data is subject to change without notice and revision of this document. For browser-based versions of this data sheet, refer to the left-hand navigation.

**PACKAGING INFORMATION**

Orderable Device	Status (1)	Package Type	Package Drawing	Pins	Package Qty	Eco Plan (2)	Lead finish/ Ball material (6)	MSL Peak Temp (3)	Op Temp (°C)	Device Marking (4/5)	Samples
TPS62080ADSGR	ACTIVE	WSON	DSG	8	3000	RoHS & Green	NIPDAU   NIPDAUAG	Level-2-260C-1 YEAR	-40 to 125	SBN	<a href="#">Samples</a>
TPS62080ADSGT	ACTIVE	WSON	DSG	8	250	RoHS & Green	NIPDAU   NIPDAUAG	Level-2-260C-1 YEAR	-40 to 125	SBN	<a href="#">Samples</a>
TPS62080DSGR	ACTIVE	WSON	DSG	8	3000	RoHS & Green	NIPDAU   NIPDAUAG	Level-2-260C-1 YEAR	-40 to 125	QVR	<a href="#">Samples</a>
TPS62080DSGT	ACTIVE	WSON	DSG	8	250	RoHS & Green	NIPDAU   NIPDAUAG	Level-2-260C-1 YEAR	-40 to 125	QVR	<a href="#">Samples</a>
TPS62081DSGR	ACTIVE	WSON	DSG	8	3000	RoHS & Green	NIPDAU   NIPDAUAG	Level-2-260C-1 YEAR	-40 to 125	QVS	<a href="#">Samples</a>
TPS62081DSGT	ACTIVE	WSON	DSG	8	250	RoHS & Green	NIPDAU   NIPDAUAG	Level-2-260C-1 YEAR	-40 to 125	QVS	<a href="#">Samples</a>
TPS62082DSGR	ACTIVE	WSON	DSG	8	3000	RoHS & Green	NIPDAU   NIPDAUAG	Level-2-260C-1 YEAR	-40 to 125	QVT	<a href="#">Samples</a>
TPS62082DSGT	ACTIVE	WSON	DSG	8	250	RoHS & Green	NIPDAU   NIPDAUAG	Level-2-260C-1 YEAR	-40 to 125	QVT	<a href="#">Samples</a>

(1) The marketing status values are defined as follows:

**ACTIVE:** Product device recommended for new designs.

**LIFEBUY:** TI has announced that the device will be discontinued, and a lifetime-buy period is in effect.

**NRND:** Not recommended for new designs. Device is in production to support existing customers, but TI does not recommend using this part in a new design.

**PREVIEW:** Device has been announced but is not in production. Samples may or may not be available.

**OBSOLETE:** TI has discontinued the production of the device.

(2) **RoHS:** TI defines "RoHS" to mean semiconductor products that are compliant with the current EU RoHS requirements for all 10 RoHS substances, including the requirement that RoHS substance do not exceed 0.1% by weight in homogeneous materials. Where designed to be soldered at high temperatures, "RoHS" products are suitable for use in specified lead-free processes. TI may reference these types of products as "Pb-Free".

**RoHS Exempt:** TI defines "RoHS Exempt" to mean products that contain lead but are compliant with EU RoHS pursuant to a specific EU RoHS exemption.

**Green:** TI defines "Green" to mean the content of Chlorine (Cl) and Bromine (Br) based flame retardants meet JS709B low halogen requirements of <=1000ppm threshold. Antimony trioxide based flame retardants must also meet the <=1000ppm threshold requirement.

(3) MSL, Peak Temp. - The Moisture Sensitivity Level rating according to the JEDEC industry standard classifications, and peak solder temperature.

(4) There may be additional marking, which relates to the logo, the lot trace code information, or the environmental category on the device.

(5) Multiple Device Markings will be inside parentheses. Only one Device Marking contained in parentheses and separated by a "~" will appear on a device. If a line is indented then it is a continuation of the previous line and the two combined represent the entire Device Marking for that device.

<sup>(6)</sup> Lead finish/Ball material - Orderable Devices may have multiple material finish options. Finish options are separated by a vertical ruled line. Lead finish/Ball material values may wrap to two lines if the finish value exceeds the maximum column width.

**Important Information and Disclaimer:** The information provided on this page represents TI's knowledge and belief as of the date that it is provided. TI bases its knowledge and belief on information provided by third parties, and makes no representation or warranty as to the accuracy of such information. Efforts are underway to better integrate information from third parties. TI has taken and continues to take reasonable steps to provide representative and accurate information but may not have conducted destructive testing or chemical analysis on incoming materials and chemicals. TI and TI suppliers consider certain information to be proprietary, and thus CAS numbers and other limited information may not be available for release.

In no event shall TI's liability arising out of such information exceed the total purchase price of the TI part(s) at issue in this document sold by TI to Customer on an annual basis.

**TAPE AND REEL INFORMATION**

**QUADRANT ASSIGNMENTS FOR PIN 1 ORIENTATION IN TAPE**


\*All dimensions are nominal

Device	Package Type	Package Drawing	Pins	SPQ	Reel Diameter (mm)	Reel Width W1 (mm)	A0 (mm)	B0 (mm)	K0 (mm)	P1 (mm)	W (mm)	Pin1 Quadrant
TPS62080ADSGR	WSON	DSG	8	3000	178.0	8.4	2.25	2.25	1.0	4.0	8.0	Q2
TPS62080ADSGT	WSON	DSG	8	250	178.0	8.4	2.25	2.25	1.0	4.0	8.0	Q2
TPS62080DSGR	WSON	DSG	8	3000	178.0	8.4	2.25	2.25	1.0	4.0	8.0	Q2
TPS62080DSGT	WSON	DSG	8	250	178.0	8.4	2.25	2.25	1.0	4.0	8.0	Q2
TPS62080DSGT	WSON	DSG	8	250	179.0	8.4	2.2	2.2	1.2	4.0	8.0	Q2
TPS62081DSGR	WSON	DSG	8	3000	178.0	8.4	2.25	2.25	1.0	4.0	8.0	Q2
TPS62081DSGT	WSON	DSG	8	250	178.0	8.4	2.25	2.25	1.0	4.0	8.0	Q2
TPS62082DSGR	WSON	DSG	8	3000	179.0	8.4	2.2	2.2	1.2	4.0	8.0	Q2
TPS62082DSGR	WSON	DSG	8	3000	178.0	8.4	2.25	2.25	1.0	4.0	8.0	Q2
TPS62082DSGT	WSON	DSG	8	250	179.0	8.4	2.2	2.2	1.2	4.0	8.0	Q2
TPS62082DSGT	WSON	DSG	8	250	178.0	8.4	2.25	2.25	1.0	4.0	8.0	Q2



## TAPE AND REEL BOX DIMENSIONS



\*All dimensions are nominal

Device	Package Type	Package Drawing	Pins	SPQ	Length (mm)	Width (mm)	Height (mm)
TPS62080ADSGR	WSON	DSG	8	3000	205.0	200.0	33.0
TPS62080ADSGT	WSON	DSG	8	250	205.0	200.0	33.0
TPS62080DSGR	WSON	DSG	8	3000	205.0	200.0	33.0
TPS62080DSGT	WSON	DSG	8	250	205.0	200.0	33.0
TPS62080DSGT	WSON	DSG	8	250	213.0	191.0	35.0
TPS62081DSGR	WSON	DSG	8	3000	205.0	200.0	33.0
TPS62081DSGT	WSON	DSG	8	250	205.0	200.0	33.0
TPS62082DSGR	WSON	DSG	8	3000	213.0	191.0	35.0
TPS62082DSGR	WSON	DSG	8	3000	205.0	200.0	33.0
TPS62082DSGT	WSON	DSG	8	250	213.0	191.0	35.0
TPS62082DSGT	WSON	DSG	8	250	205.0	200.0	33.0

## GENERIC PACKAGE VIEW

**DSG 8**

**WSON - 0.8 mm max height**

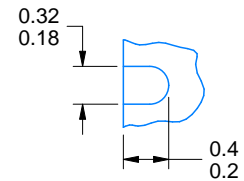
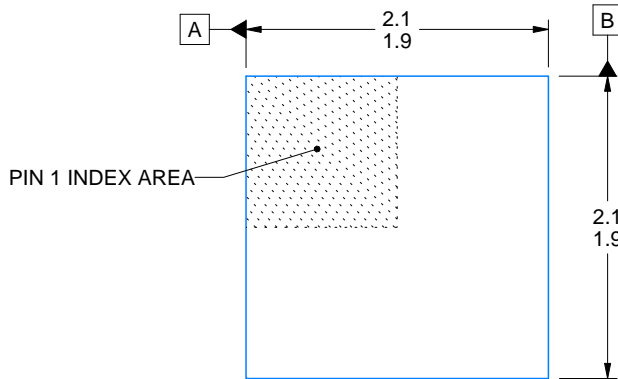
2 x 2, 0.5 mm pitch

PLASTIC SMALL OUTLINE - NO LEAD

This image is a representation of the package family, actual package may vary.  
Refer to the product data sheet for package details.



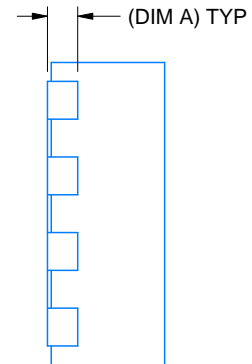
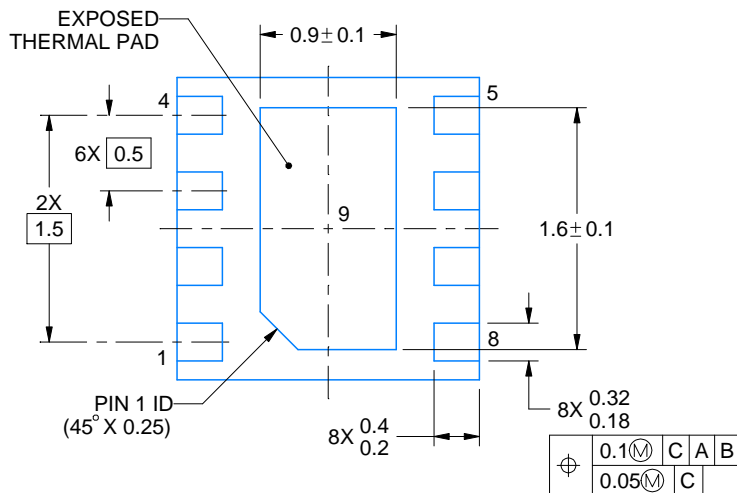
4224783/A



ALTERNATIVE TERMINAL SHAPE TYPICAL



SIDE WALL METAL THICKNESS DIM A	
OPTION 1	OPTION 2
0.1	0.2



4218900/E 08/2022

NOTES:

1. All linear dimensions are in millimeters. Any dimensions in parenthesis are for reference only. Dimensioning and tolerancing per ASME Y14.5M.
2. This drawing is subject to change without notice.
3. The package thermal pad must be soldered to the printed circuit board for thermal and mechanical performance.

# EXAMPLE BOARD LAYOUT

DSG0008A

WSON - 0.8 mm max height

PLASTIC SMALL OUTLINE - NO LEAD



LAND PATTERN EXAMPLE  
SCALE:20X



SOLDER MASK DETAILS

4218900/E 08/2022

NOTES: (continued)

4. This package is designed to be soldered to a thermal pad on the board. For more information, see Texas Instruments literature number SLUA271 ([www.ti.com/lit/slua271](http://www.ti.com/lit/slua271)).
5. Vias are optional depending on application, refer to device data sheet. If any vias are implemented, refer to their locations shown on this view. It is recommended that vias under paste be filled, plugged or tented.

# EXAMPLE STENCIL DESIGN

DSG0008A

WSON - 0.8 mm max height

PLASTIC SMALL OUTLINE - NO LEAD



SOLDER PASTE EXAMPLE  
BASED ON 0.125 mm THICK STENCIL

EXPOSED PAD 9:  
87% PRINTED SOLDER COVERAGE BY AREA UNDER PACKAGE  
SCALE:25X

4218900/E 08/2022

NOTES: (continued)

6. Laser cutting apertures with trapezoidal walls and rounded corners may offer better paste release. IPC-7525 may have alternate design recommendations.

## IMPORTANT NOTICE AND DISCLAIMER

TI PROVIDES TECHNICAL AND RELIABILITY DATA (INCLUDING DATA SHEETS), DESIGN RESOURCES (INCLUDING REFERENCE DESIGNS), APPLICATION OR OTHER DESIGN ADVICE, WEB TOOLS, SAFETY INFORMATION, AND OTHER RESOURCES "AS IS" AND WITH ALL FAULTS, AND DISCLAIMS ALL WARRANTIES, EXPRESS AND IMPLIED, INCLUDING WITHOUT LIMITATION ANY IMPLIED WARRANTIES OF MERCHANTABILITY, FITNESS FOR A PARTICULAR PURPOSE OR NON-INFRINGEMENT OF THIRD PARTY INTELLECTUAL PROPERTY RIGHTS.

These resources are intended for skilled developers designing with TI products. You are solely responsible for (1) selecting the appropriate TI products for your application, (2) designing, validating and testing your application, and (3) ensuring your application meets applicable standards, and any other safety, security, regulatory or other requirements.

These resources are subject to change without notice. TI grants you permission to use these resources only for development of an application that uses the TI products described in the resource. Other reproduction and display of these resources is prohibited. No license is granted to any other TI intellectual property right or to any third party intellectual property right. TI disclaims responsibility for, and you will fully indemnify TI and its representatives against, any claims, damages, costs, losses, and liabilities arising out of your use of these resources.

TI's products are provided subject to [TI's Terms of Sale](#) or other applicable terms available either on [ti.com](https://www.ti.com) or provided in conjunction with such TI products. TI's provision of these resources does not expand or otherwise alter TI's applicable warranties or warranty disclaimers for TI products.

TI objects to and rejects any additional or different terms you may have proposed.

Mailing Address: Texas Instruments, Post Office Box 655303, Dallas, Texas 75265  
Copyright © 2023, Texas Instruments Incorporated

单击下面可查看定价，库存，交付和生命周期等信息

[>>TI\(德州仪器\)](#)