

## TLV733P Capacitor-Free, 300-mA, Low-Dropout Regulator in 1-mm x 1-mm X2SON Package

### 1 Features

- Input Voltage Range: 1.4 V to 5.5 V
- Stable Operation With or Without Capacitors
- Foldback Overcurrent Protection
- Packages:
  - 1.0-mm x 1.0-mm X2SON (4)
  - SOT-23 (5)
- Very Low Dropout: 125 mV at 300 mA (3.3 V<sub>OUT</sub>)
- Accuracy: 1% typical, 1.4% maximum
- Low I<sub>Q</sub>: 34 μA
- Available in Fixed-Output Voltages: 1.0 V to 3.3 V
- High PSRR: 50 dB at 1 kHz
- Active Output Discharge

### 2 Applications

- Tablets
- Smartphones
- Notebook and Desktop Computers
- Portable Industrial and Consumer Products
- WLAN and Other PC Add-On Cards
- Camera Modules

### 3 Description

The TLV733 series of low-dropout linear regulators (LDOs) are ultra-small, low quiescent current LDOs that can source 300 mA with good line and load transient performance. These devices provide a typical accuracy of 1%.

The TLV733 series is designed with a modern capacitor-free architecture to ensure stability without an input or output capacitor. The removal of the output capacitor allows for a very small solution size, and can eliminate inrush current at startup. However, the TLV733 series is also stable with ceramic output capacitors if an output capacitor is necessary. The TLV733 also provides foldback current control during device power-up and enabling if an output capacitor is used. This functionality is especially important in battery-operated devices.

The TLV733 provides an active pull-down circuit to quickly discharge output loads when disabled.

The TLV733 series is available in standard DBV (SOT-23) and DQN (X2SON) packages.

#### Device Information<sup>(1)</sup>

PART NUMBER	PACKAGE	BODY SIZE (NOM)
TLV733P	SOT-23 (5)	2.90 mm x 1.60 mm
	X2SON (4)	1.00 mm x 1.00 mm

(1) For all available packages, see the package option addendum at the end of the data sheet.

#### Typical Application Circuit

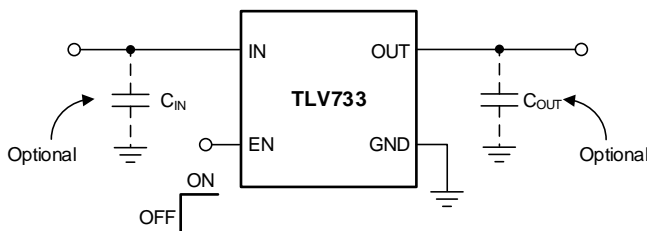

#### Dropout Voltage vs Output Current

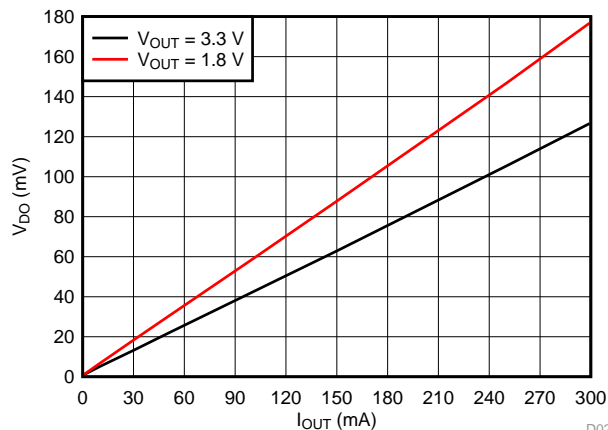

D020



An IMPORTANT NOTICE at the end of this data sheet addresses availability, warranty, changes, use in safety-critical applications, intellectual property matters and other important disclaimers. PRODUCTION DATA.

## Table of Contents

<b>1 Features</b> .....	<b>1</b>	<b>8 Application and Implementation</b> .....	<b>16</b>
<b>2 Applications</b> .....	<b>1</b>	8.1 Application Information.....	16
<b>3 Description</b> .....	<b>1</b>	8.2 Typical Applications .....	18
<b>4 Revision History</b> .....	<b>2</b>	<b>9 Power Supply Recommendations</b> .....	<b>20</b>
<b>5 Pin Configuration and Functions</b> .....	<b>4</b>	<b>10 Layout</b> .....	<b>20</b>
<b>6 Specifications</b> .....	<b>5</b>	10.1 Layout Guidelines .....	20
6.1 Absolute Maximum Ratings .....	5	10.2 Layout Examples.....	20
6.2 ESD Ratings.....	5	<b>11 Device and Documentation Support</b> .....	<b>21</b>
6.3 Recommended Operating Conditions.....	5	11.1 Device Support .....	21
6.4 Thermal Information .....	5	11.2 Documentation Support .....	21
6.5 Electrical Characteristics.....	6	11.3 Receiving Notification of Documentation Updates	21
6.6 Typical Characteristics .....	7	11.4 Community Resources.....	21
<b>7 Detailed Description</b> .....	<b>13</b>	11.5 Trademarks .....	21
7.1 Overview .....	13	11.6 Electrostatic Discharge Caution.....	21
7.2 Functional Block Diagram .....	13	11.7 Glossary .....	22
7.3 Feature Description.....	14	<b>12 Mechanical, Packaging, and Orderable</b>	<b>Information</b> .....
7.4 Device Functional Modes.....	15		<b>22</b>

## 4 Revision History

Changes from Revision B (November 2015) to Revision C	Page
• Changed description of EN pin from 0.9 V to $V_{EN(HI)}$ and from 0.35 V to $V_{EN(LO)}$ .....	4
• Deleted typical specifications from $V_{EN(HI)}$ and $V_{EN(LO)}$ parameters .....	6
• Added maximum specification to $I_{LIM}$ parameter .....	6
• Changed <i>Shutdown and Output Enable</i> title from <i>Shutdown</i> and changed first paragraph.....	14
• Added DBV package to last paragraph of <i>Power Dissipation</i> section.....	17
• Added (3) to <i>Device Nomenclature</i> table .....	21

Changes from Revision A (December 2014) to Revision B	Page
• Changed Low Dropout Feature bullet value from 122 mV to 125 mV to match value in <i>Electrical Characteristics</i> .....	1
• Changed $V_{OUT}$ labels on front page plot.....	1
• Changed min junction temperature value from -55 to -40 in <i>Absolute Maximum Ratings</i> table .....	5
• Changed max junction temperature value from 160 to 150 in <i>Absolute Maximum Ratings</i> table .....	5
• Changed max storage temperature value from 150 to 160 in <i>Absolute Maximum Ratings</i> table.....	5
• Added test condition to line regulation parameter in <i>Electrical Characteristics</i> table.....	6
• Changed unit for line regulation parameter from mV/V to mV .....	6
• Added test condition to load regulation parameter in <i>Electrical Characteristics</i> table .....	6

Changes from Original (October 2014) to Revision A	Page
• Changed top page header information for data sheet to reflect device family instead of individual devices.....	1
• Changed Input Voltage Range Features bullet to be first in list.....	1
• Changed <i>Typical Application Circuit</i> on front page; corrected error in optional capacitor identification .....	1
• Changed format of I/O column contents and order of packages in <i>Pin Functions</i> table .....	4
• Moved storage temperature range specification to <i>Absolute Maximum Ratings</i> table .....	5
• Changed <i>Handling Ratings</i> table title to <i>ESD Ratings</i> , updated table format.....	5
• Added new first row to the $V_{DO}$ parameter in the <i>Electrical Characteristics</i> table.....	6

---

- Changed condition text for [Figure 34](#) ..... 17
- Added *Evaluation Module* subsection ..... 21
- Deleted *Related Links* section ..... 21

---

## 5 Pin Configuration and Functions

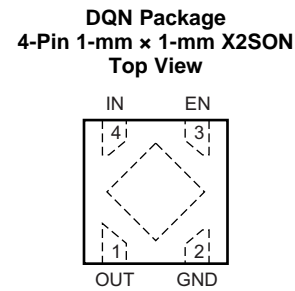
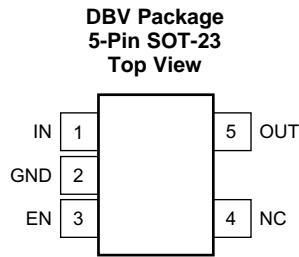

### Pin Functions

NAME	PIN NO.		I/O	DESCRIPTION
	DQN	DBV		
EN	3	3	I	Enable pin. Drive EN greater than $V_{EN(HI)}$ to turn on the regulator. Drive EN less than $V_{EN(LO)}$ to put the LDO into shutdown mode.
GND	2	2	—	Ground pin
IN	4	1	I	Input pin. A small capacitor is recommended from this pin to ground. See the <a href="#">Input and Output Capacitor Selection</a> section for more details.
NC	N/A	4	—	No internal connection
OUT	1	5	O	Regulated output voltage pin. For best transient response, use a small 1- $\mu$ F ceramic capacitor from this pin to ground. See the <a href="#">Input and Output Capacitor Selection</a> section for more details.
Thermal pad	—	—	—	The thermal pad is electrically connected to the GND node. Connect to the GND plane for improved thermal performance.

## 6 Specifications

### 6.1 Absolute Maximum Ratings

over operating junction temperature range (unless otherwise noted); all voltages are with respect to GND<sup>(1)</sup>

		MIN	MAX	UNIT
Voltage	V <sub>IN</sub>	-0.3	6.0	V
	V <sub>EN</sub>	-0.3	V <sub>IN</sub> + 0.3	
	V <sub>OUT</sub>	-0.3	3.6	
Current	I <sub>OUT</sub>	Internally limited		A
Output short-circuit duration		Indefinite		
Temperature	Operating junction, T <sub>J</sub>	-40	150	°C
	Storage, T <sub>stg</sub>	-65	160	

(1) Stresses beyond those listed under *Absolute Maximum Ratings* may cause permanent damage to the device. These are stress ratings only, which do not imply functional operation of the device at these or any other conditions beyond those indicated under *Recommended Operating Conditions*. Exposure to absolute-maximum-rated conditions for extended periods may affect device reliability.

### 6.2 ESD Ratings

			VALUE	UNIT
V <sub>(ESD)</sub>	Electrostatic discharge	Human-body model (HBM), per ANSI/ESDA/JEDEC JS-001 <sup>(1)</sup>	±2000	V
		Charged-device model (CDM), per JEDEC specification JESD22-C101 <sup>(2)</sup>	±500	

(1) JEDEC document JEP155 states that 500-V HBM allows safe manufacturing with a standard ESD control process.

(2) JEDEC document JEP157 states that 250-V CDM allows safe manufacturing with a standard ESD control process.

### 6.3 Recommended Operating Conditions

over operating junction temperature range (unless otherwise noted)

	MIN	NOM	MAX	UNIT
Input range, V <sub>IN</sub>	1.4		5.5	V
Output range, V <sub>OUT</sub>	1.0		3.3	V
Output current, I <sub>OUT</sub>	0		300	mA
Enable range, V <sub>EN</sub>	0		V <sub>IN</sub>	V
Junction temperature, T <sub>J</sub>	-40		125	°C

### 6.4 Thermal Information

THERMAL METRIC <sup>(1)</sup>		TLV733P		UNIT
		DQN (X2SON)	DBV (SOT-23)	
		4 PINS	5 PINS	
R <sub>θJA</sub>	Junction-to-ambient thermal resistance	218.6	228.4	°C/W
R <sub>θJC(top)</sub>	Junction-to-case (top) thermal resistance	164.8	151.5	°C/W
R <sub>θJB</sub>	Junction-to-board thermal resistance	164.9	55.8	°C/W
ψ <sub>JT</sub>	Junction-to-top characterization parameter	5.6	31.4	°C/W
ψ <sub>JB</sub>	Junction-to-board characterization parameter	163.9	54.8	°C/W
R <sub>θJC(bot)</sub>	Junction-to-case (bottom) thermal resistance	131.4	N/A	°C/W

(1) For more information about traditional and new thermal metrics, see the [Semiconductor and IC Package Thermal Metrics application report](#).

## 6.5 Electrical Characteristics

At operating temperature range ( $T_J = -40^\circ\text{C}$  to  $+125^\circ\text{C}$ ),  $V_{IN} = V_{OUT}(\text{nom}) + 0.5\text{ V}$  or  $2.0\text{ V}$  (whichever is greater),  $I_{OUT} = 1\text{ mA}$ ,  $V_{EN} = V_{IN}$ , and  $C_{IN} = C_{OUT} = 1\ \mu\text{F}$  (unless otherwise noted). All typical values at  $T_J = 25^\circ\text{C}$ .

PARAMETER		TEST CONDITIONS		MIN	TYP	MAX	UNIT
$V_{IN}$	Input voltage			1.4		5.5	V
	DC output accuracy	$T_J = 25^\circ\text{C}$		-1%		1%	
		$-40^\circ\text{C} \leq T_J \leq +125^\circ\text{C}$		-1.4%		1.4%	
UVLO	Undervoltage lockout	$V_{IN}$ rising			1.3	1.4	V
		$V_{IN}$ falling			1.25		
$\Delta V_{O(\Delta V)}$	Line regulation	$\Delta VI = V_{IN}(\text{nom})$ to $V_{IN}(\text{nom}) + 1$			1		mV
$\Delta V_{O(\Delta IO)}$	Load regulation	$\Delta IO = 1\text{ mA}$ to $300\text{ mA}$	DQN package		16		mV
			DBV package		25		
$V_{DO}$	Dropout voltage <sup>(1)</sup>	$V_{OUT} = 0.98 \times V_{OUT}(\text{nom})$ , $I_{OUT} = 300\text{ mA}$	$V_{OUT} = 1.1\text{ V}$ , $-40^\circ\text{C} \leq T_J \leq 85^\circ\text{C}$			460	mV
			$1.2\text{ V} \leq V_{OUT} < 1.5\text{ V}$ , $-40^\circ\text{C} \leq T_J \leq 85^\circ\text{C}$			420	
			$1.5\text{ V} \leq V_{OUT} < 1.8\text{ V}$ , $-40^\circ\text{C} \leq T_J \leq 85^\circ\text{C}$			370	
			$1.8\text{ V} \leq V_{OUT} < 2.5\text{ V}$ , $-40^\circ\text{C} \leq T_J \leq 85^\circ\text{C}$			270	
			$2.5\text{ V} \leq V_{OUT} < 3.3\text{ V}$ , $-40^\circ\text{C} \leq T_J \leq 85^\circ\text{C}$			260	
			$V_{OUT} = 3.3\text{ V}$ , $-40^\circ\text{C} \leq T_J \leq 85^\circ\text{C}$		125	220	
			$1.2\text{ V} \leq V_{OUT} < 1.5\text{ V}$ , $-40^\circ\text{C} \leq T_J \leq 125^\circ\text{C}$			450	
			$1.5\text{ V} \leq V_{OUT} < 1.8\text{ V}$ , $-40^\circ\text{C} \leq T_J \leq 125^\circ\text{C}$			400	
			$1.8\text{ V} \leq V_{OUT} < 2.5\text{ V}$ , $-40^\circ\text{C} \leq T_J \leq 125^\circ\text{C}$			300	
			$2.5\text{ V} \leq V_{OUT} < 3.3\text{ V}$ , $-40^\circ\text{C} \leq T_J \leq 125^\circ\text{C}$			290	
			$V_{OUT} = 3.3\text{ V}$ , $-40^\circ\text{C} \leq T_J \leq 125^\circ\text{C}$		125	270	
$I_{GND}$	Ground pin current	$I_{OUT} = 0\text{ mA}$			34	60	$\mu\text{A}$
$I_{SHDN}$	Shutdown current	$V_{EN} \leq 0.35\text{ V}$ , $2.0\text{ V} \leq V_{IN} \leq 5.5\text{ V}$ , $T_J = 25^\circ\text{C}$			0.1	1	$\mu\text{A}$
PSRR	Power-supply rejection ratio	$V_{OUT} = 1.8\text{ V}$ , $I_{OUT} = 300\text{ mA}$	$f = 100\text{ Hz}$		68		dB
			$f = 10\text{ kHz}$		35		
			$f = 100\text{ kHz}$		28		
$V_n$	Output noise voltage	BW = 10 Hz to 100 kHz, $V_{OUT} = 1.8\text{ V}$ , $I_{OUT} = 10\text{ mA}$			120		$\mu\text{V}_{\text{RMS}}$
$V_{EN(HI)}$	EN pin high voltage (enabled)			0.9			V
$V_{EN(LO)}$	EN pin low voltage (disabled)					0.35	V
$I_{EN}$	EN pin current	$V_{EN} = 5.5\text{ V}$			0.01		$\mu\text{A}$
$t_{STR}$	Startup time	Time from EN assertion to $98\% \times V_{OUT}(\text{nom})$ , $V_{OUT} = 1.0\text{ V}$ , $I_{OUT} = 0\text{ mA}$			250		$\mu\text{s}$
		Time from EN assertion to $98\% \times V_{OUT}(\text{nom})$ , $V_{OUT} = 3.3\text{ V}$ , $I_{OUT} = 0\text{ mA}$			800		
	Pull-down resistor	$V_{IN} = 2.3\text{ V}$			120		$\Omega$
$I_{LIM}$	Output current limit			360		700	mA
$I_{OS}$	Short-circuit current limit	$V_{OUT}$ shorted to GND, $V_{OUT} = 1.0\text{ V}$			150		mA
		$V_{OUT}$ shorted to GND, $V_{OUT} = 3.3\text{ V}$			170		
$T_{sd}$	Thermal shutdown	Shutdown, temperature increasing			160		$^\circ\text{C}$
		Reset, temperature decreasing			140		

(1) Dropout voltage for the TLV73310P is not valid at room temperature. The device engages undervoltage lockout ( $V_{IN} < UVLO_{\text{FALL}}$ ) before the dropout condition is met.

## 6.6 Typical Characteristics

at operating temperature range ( $T_J = -40^\circ\text{C}$  to  $+125^\circ\text{C}$ ),  $V_{IN} = V_{OUT(nom)} + 0.5\text{ V}$  or  $2.0\text{ V}$  (whichever is greater),  $I_{OUT} = 1\text{ mA}$ ,  $V_{EN} = V_{IN}$ , and  $C_{IN} = C_{OUT} = 1\ \mu\text{F}$  (unless otherwise noted)

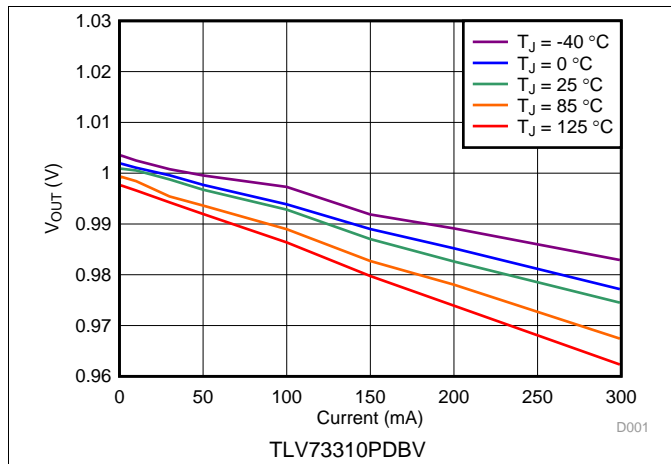

Figure 1. 1.0-V Load Regulation vs  $I_{OUT}$  and Temperature

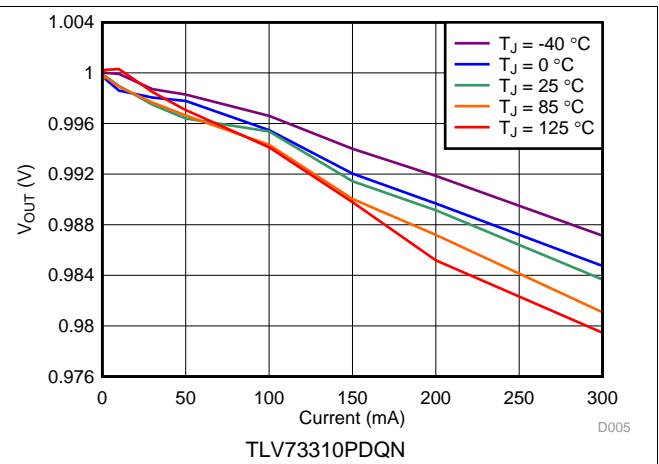

Figure 2. 1.0-V Load Regulation vs  $I_{OUT}$  and Temperature

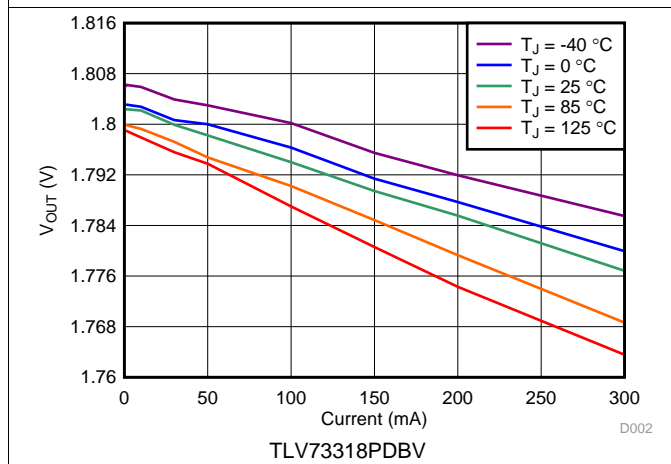

Figure 3. 1.8-V Load Regulation vs  $I_{OUT}$  and Temperature

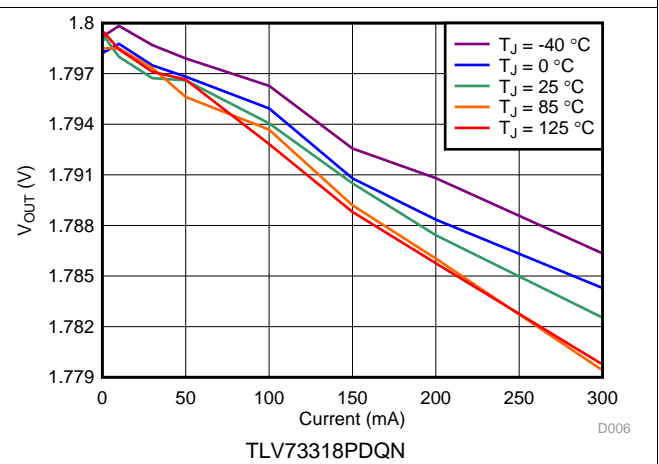

Figure 4. 1.8-V Load Regulation vs  $I_{OUT}$  and Temperature

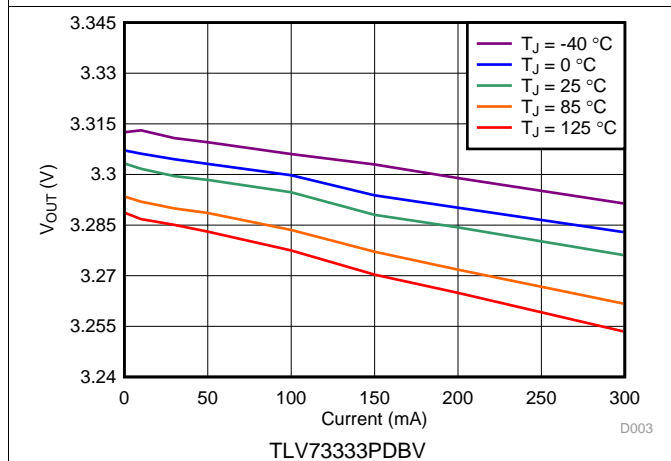

Figure 5. 3.3-V Load Regulation vs  $I_{OUT}$  and Temperature

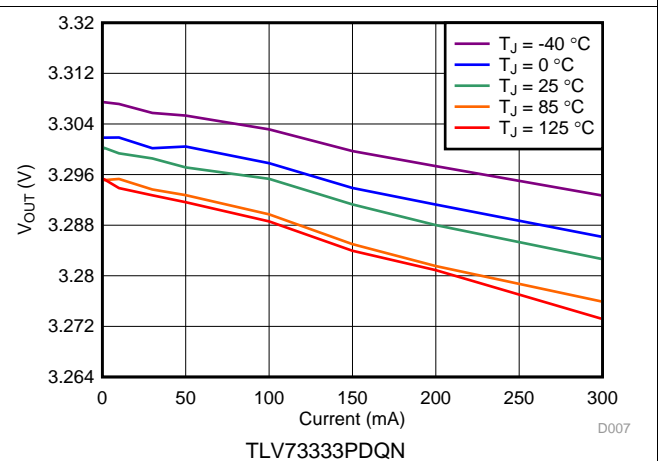

Figure 6. 3.3-V Load Regulation vs  $I_{OUT}$  and Temperature

### Typical Characteristics (continued)

at operating temperature range ( $T_J = -40^{\circ}\text{C}$  to  $+125^{\circ}\text{C}$ ),  $V_{IN} = V_{OUT(nom)} + 0.5\text{ V}$  or  $2.0\text{ V}$  (whichever is greater),  $I_{OUT} = 1\text{ mA}$ ,  $V_{EN} = V_{IN}$ , and  $C_{IN} = C_{OUT} = 1\text{ }\mu\text{F}$  (unless otherwise noted)

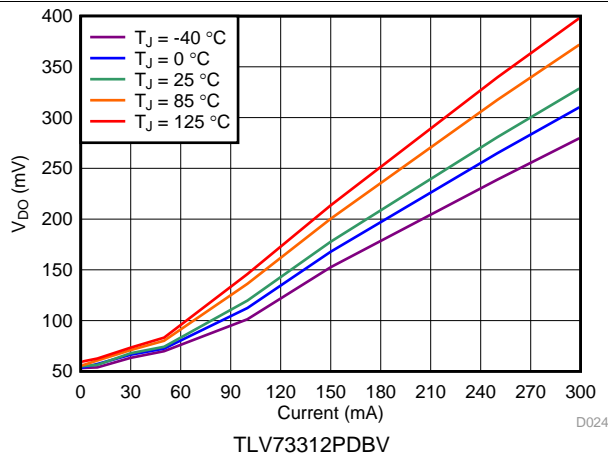

Figure 7. 1.2-V Dropout Voltage vs  $I_{OUT}$  and Temperature

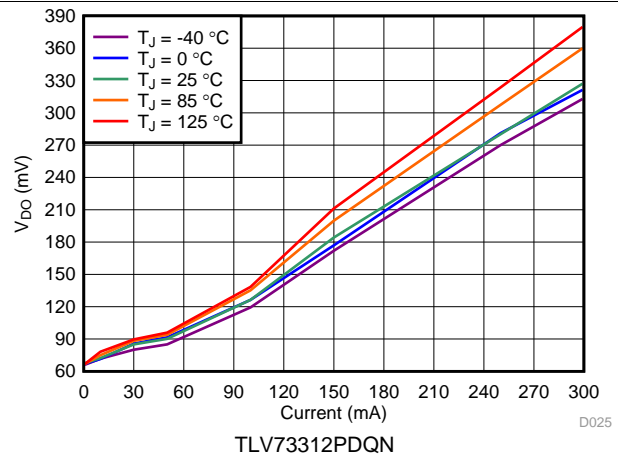

Figure 8. 1.2-V Dropout Voltage vs  $I_{OUT}$  and Temperature

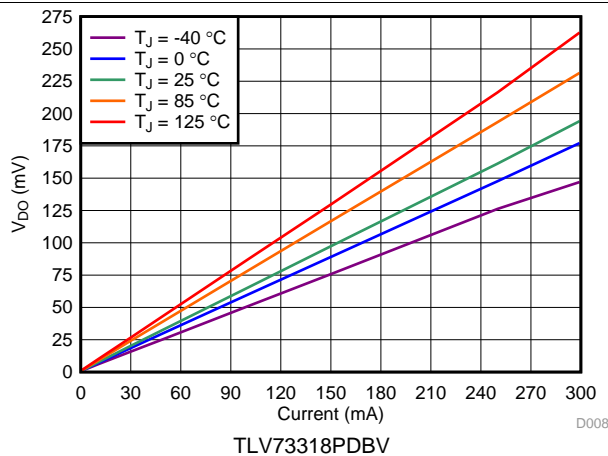

Figure 9. 1.8-V Dropout Voltage vs  $I_{OUT}$  and Temperature

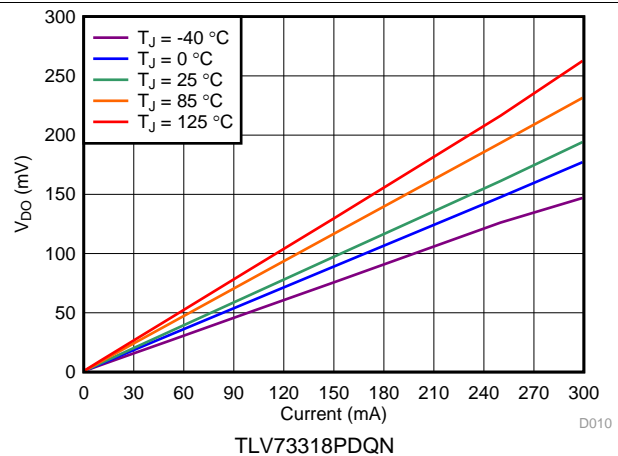

Figure 10. 1.8-V Dropout Voltage vs  $I_{OUT}$  and Temperature

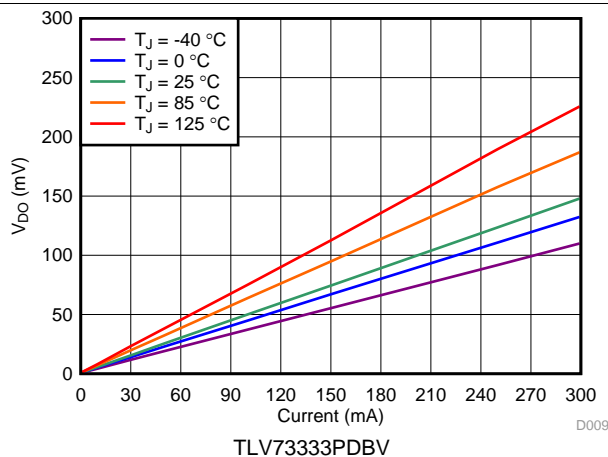

Figure 11. 3.3-V Dropout Voltage vs  $I_{OUT}$  and Temperature

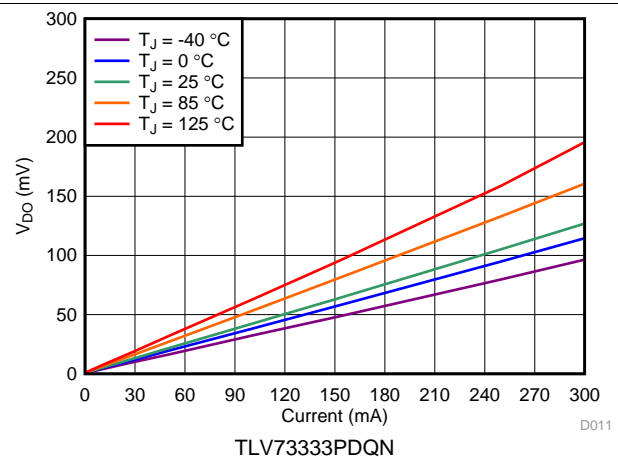

Figure 12. 3.3-V Dropout Voltage vs  $I_{OUT}$  and Temperature



Typical Characteristics (continued)

at operating temperature range ( $T_J = -40^{\circ}\text{C}$  to  $+125^{\circ}\text{C}$ ),  $V_{IN} = V_{OUT(nom)} + 0.5\text{ V}$  or  $2.0\text{ V}$  (whichever is greater),  $I_{OUT} = 1\text{ mA}$ ,  $V_{EN} = V_{IN}$ , and  $C_{IN} = C_{OUT} = 1\text{ }\mu\text{F}$  (unless otherwise noted)

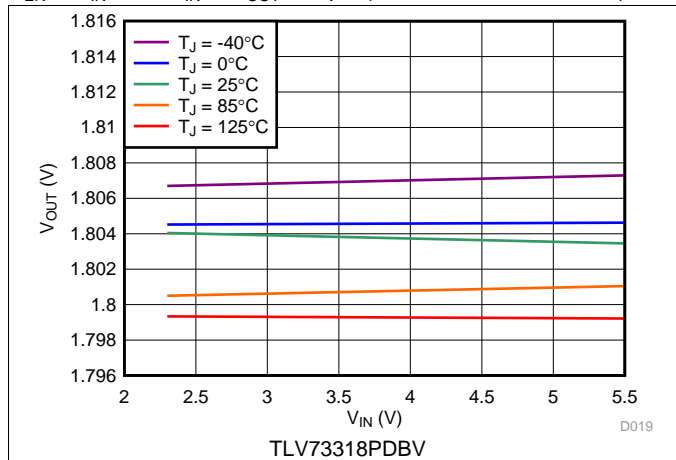

Figure 13. 1.8-V Regulation vs  $V_{IN}$  (Line Regulation) and Temperature

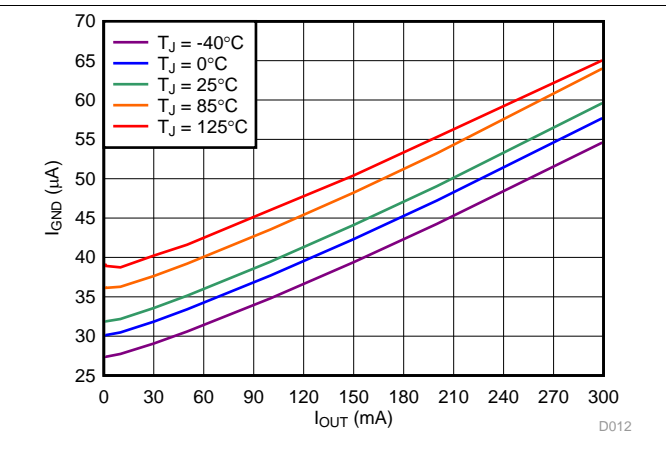

Figure 14. Ground Pin Current vs  $I_{OUT}$  and Temperature

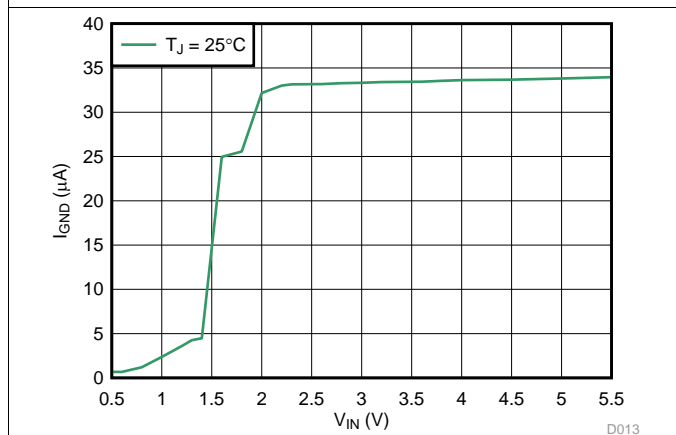

Figure 15. Ground Pin Current vs  $V_{IN}$

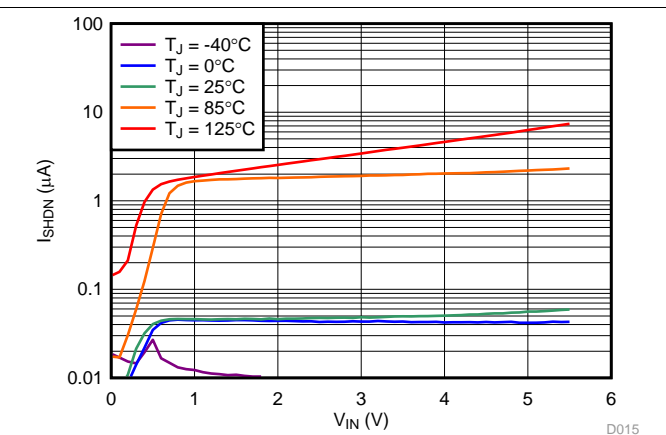

Figure 16. Shutdown Current vs  $V_{IN}$  and Temperature

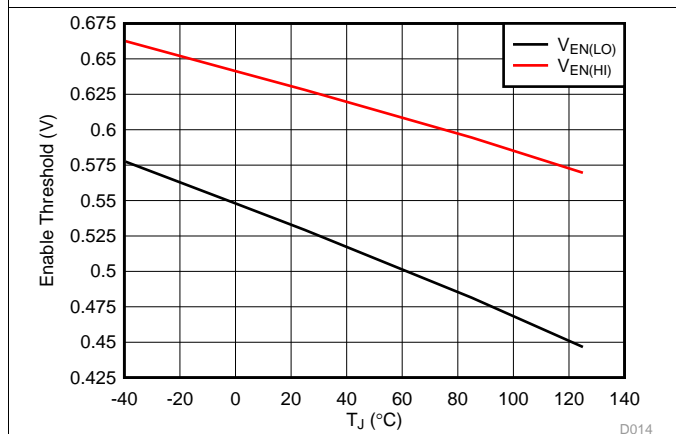

Figure 17. Enable Threshold vs Temperature

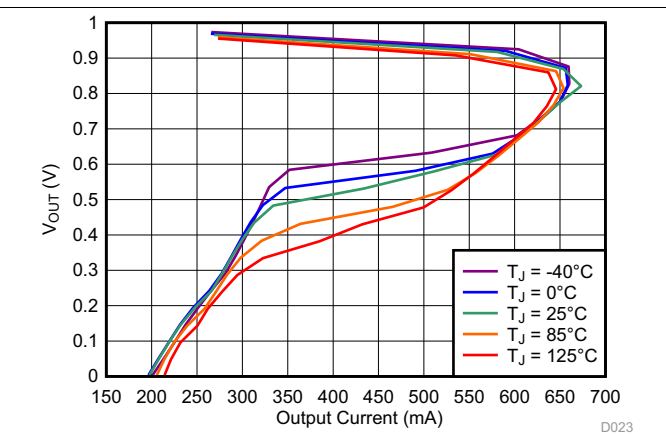

Figure 18. 1.0-V Foldback Current Limit vs  $I_{OUT}$  and Temperature

Typical Characteristics (continued)

at operating temperature range ( $T_J = -40^{\circ}\text{C}$  to  $+125^{\circ}\text{C}$ ),  $V_{IN} = V_{OUT}(\text{nom}) + 0.5\text{ V}$  or  $2.0\text{ V}$  (whichever is greater),  $I_{OUT} = 1\text{ mA}$ ,  $V_{EN} = V_{IN}$ , and  $C_{IN} = C_{OUT} = 1\ \mu\text{F}$  (unless otherwise noted)

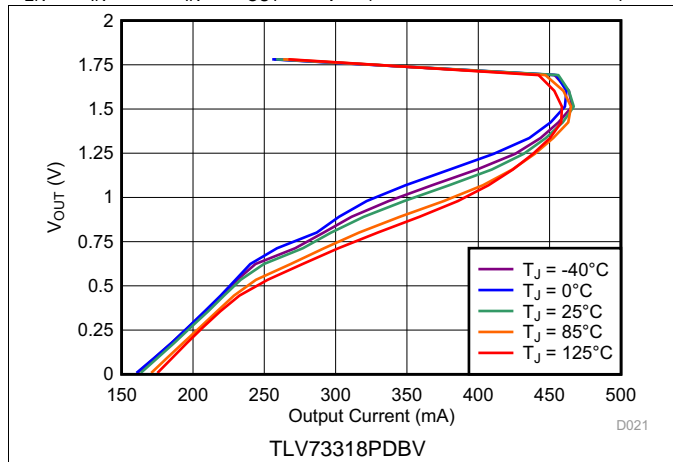

Figure 19. 1.8-V Foldback Current Limit vs  $I_{OUT}$  and Temperature

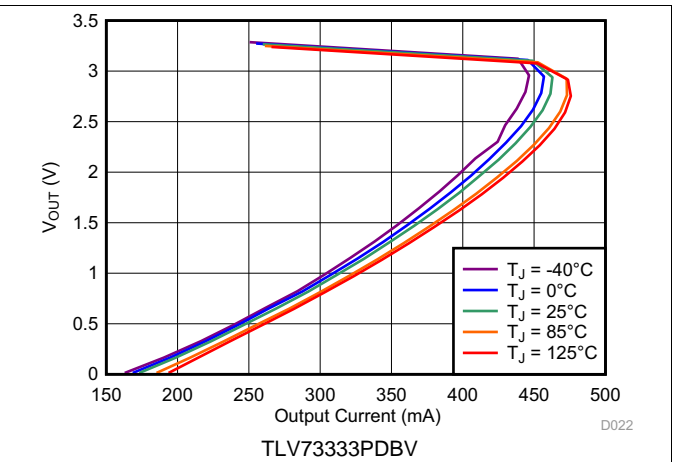

Figure 20. 3.3-V Foldback Current Limit vs  $I_{OUT}$  and Temperature

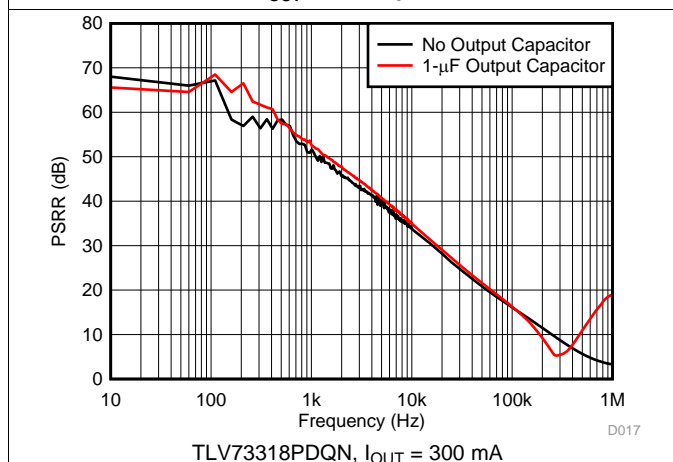

Figure 21. Power-Supply Rejection Ratio vs Frequency

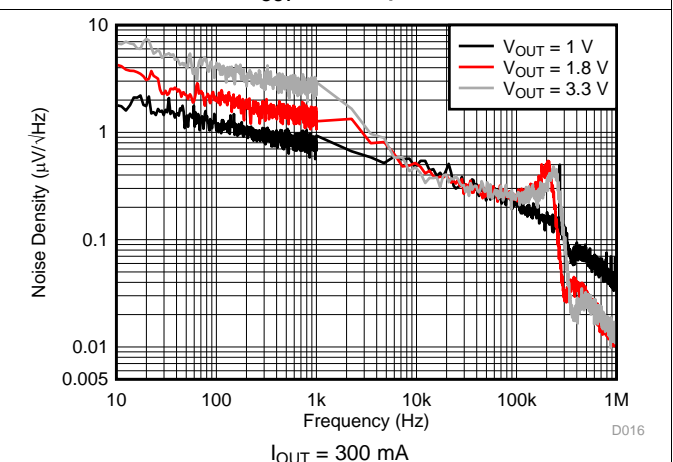

Figure 22. Output Spectral Noise Density

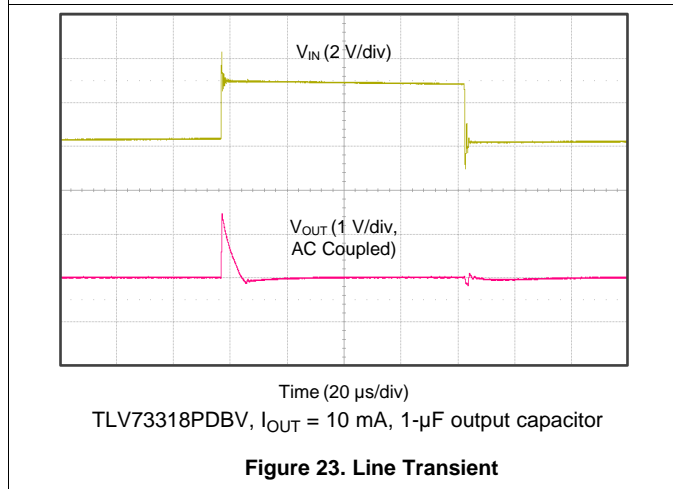

Figure 23. Line Transient

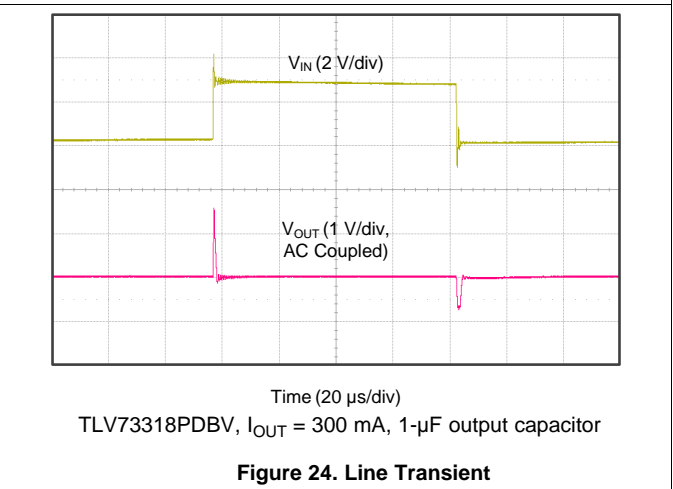
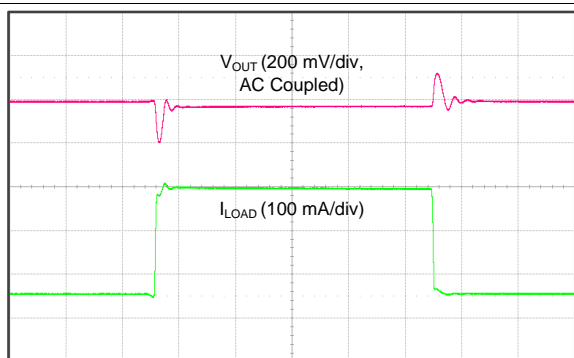

Figure 24. Line Transient

Typical Characteristics (continued)

at operating temperature range ( $T_J = -40^{\circ}\text{C}$  to  $+125^{\circ}\text{C}$ ),  $V_{IN} = V_{OUT(nom)} + 0.5\text{ V}$  or  $2.0\text{ V}$  (whichever is greater),  $I_{OUT} = 1\text{ mA}$ ,  $V_{EN} = V_{IN}$ , and  $C_{IN} = C_{OUT} = 1\text{ }\mu\text{F}$  (unless otherwise noted)



Time (20  $\mu\text{s}/\text{div}$ )  
 TLV73310PDBV,  $V_{IN} = 2.0\text{ V}$ ,  $1\text{-}\mu\text{F}$  output capacitor, output current slew rate =  $0.25\text{ A}/\mu\text{s}$

Figure 25. 1.0-V, 50-mA to 300-mA Load Transient

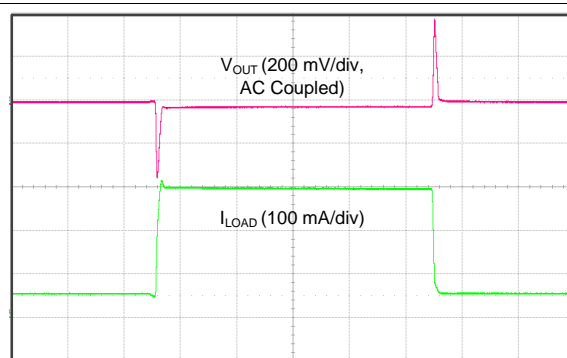

Time (20  $\mu\text{s}/\text{div}$ )  
 TLV73310PDBV,  $V_{IN} = 2.0\text{ V}$ , no output capacitor, output current slew rate =  $0.25\text{ A}/\mu\text{s}$

Figure 26. 1.0 V, 50-mA to 300-mA Load Transient

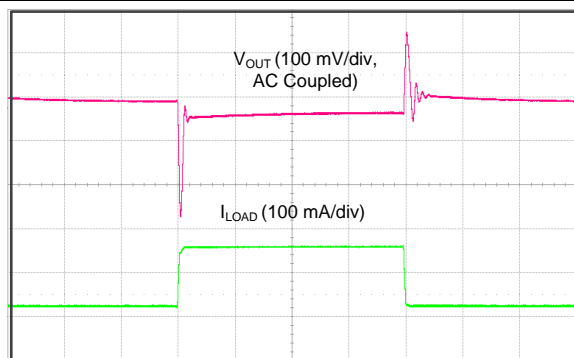

Time (20  $\mu\text{s}/\text{div}$ )  
 TLV73333PDBV,  $V_{IN} = 3.8\text{ V}$ ,  $1\text{-}\mu\text{F}$  output capacitor, output current slew rate =  $0.25\text{ A}/\mu\text{s}$

Figure 27. 3.3 V, 50-mA to 300-mA Load Transient

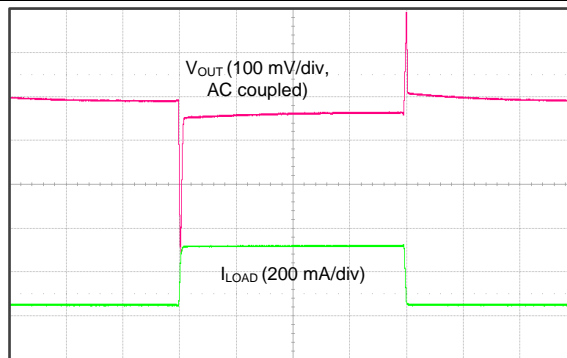

Time (50  $\mu\text{s}/\text{div}$ )  
 TLV73333PDBV,  $V_{IN} = 3.8\text{ V}$ , no output capacitor, output current slew rate =  $0.25\text{ A}/\mu\text{s}$

Figure 28. 3.3 V, 50-mA to 300-mA Load Transient

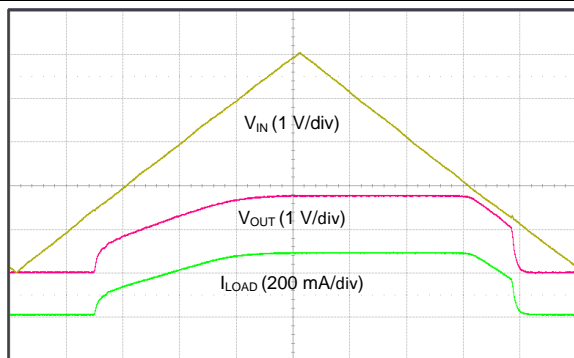

Time (100  $\mu\text{s}/\text{div}$ )  
 TLV73318PDBV,  $R_L = 6.2\text{ }\Omega$ ,  $V_{EN} = V_{IN}$ ,  $1\text{-}\mu\text{F}$  output capacitor

Figure 29.  $V_{IN}$  Power-Up and Power-Down

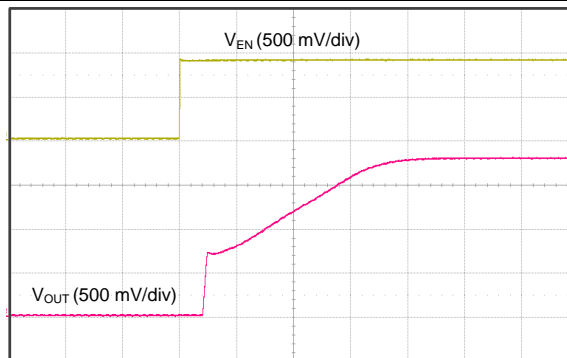

Time (100  $\mu\text{s}/\text{div}$ )  
 TLV73318PDBV,  $R_L = 6.2\text{ }\Omega$ ,  $1\text{-}\mu\text{F}$  output capacitor

Figure 30. Startup with EN

## Typical Characteristics (continued)

at operating temperature range ( $T_J = -40^{\circ}\text{C}$  to  $+125^{\circ}\text{C}$ ),  $V_{IN} = V_{OUT}(\text{nom}) + 0.5\text{ V}$  or  $2.0\text{ V}$  (whichever is greater),  $I_{OUT} = 1\text{ mA}$ ,  $V_{EN} = V_{IN}$ , and  $C_{IN} = C_{OUT} = 1\ \mu\text{F}$  (unless otherwise noted)

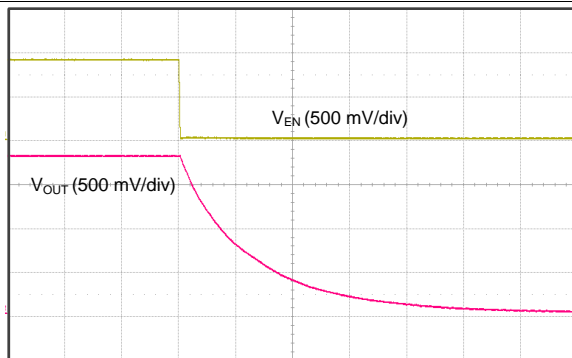

Time (100  $\mu\text{s}/\text{div}$ )  
TLV73318PDBV,  $I_{OUT} = 300\text{ mA}$ ,  $1\text{-}\mu\text{F}$  output capacitor

**Figure 31. Shutdown Response with Enable**

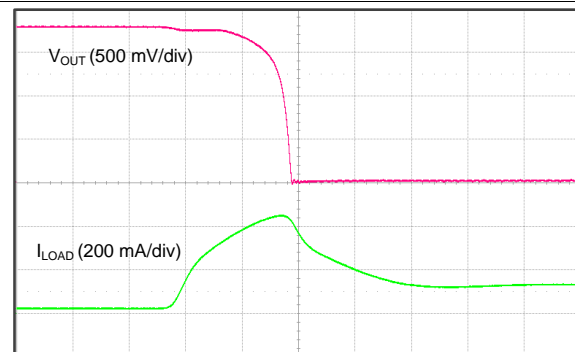

Time (100  $\mu\text{s}/\text{div}$ )  
TLV73318PDBV,  $1\text{-}\mu\text{F}$  output capacitor

**Figure 32. Foldback Current Limit Response**

## 7 Detailed Description

### 7.1 Overview

The TLV733 belongs to a new family of next-generation, low-dropout regulators (LDOs). These devices consume low quiescent current and deliver excellent line and load transient performance. These characteristics, combined with low noise, good PSRR with low dropout voltage, make this family of devices ideal for portable consumer applications.

This family of regulators offers foldback current limit, shutdown, and thermal protection. The operating junction temperature for this family of devices is  $-40^{\circ}\text{C}$  to  $125^{\circ}\text{C}$ .

### 7.2 Functional Block Diagram

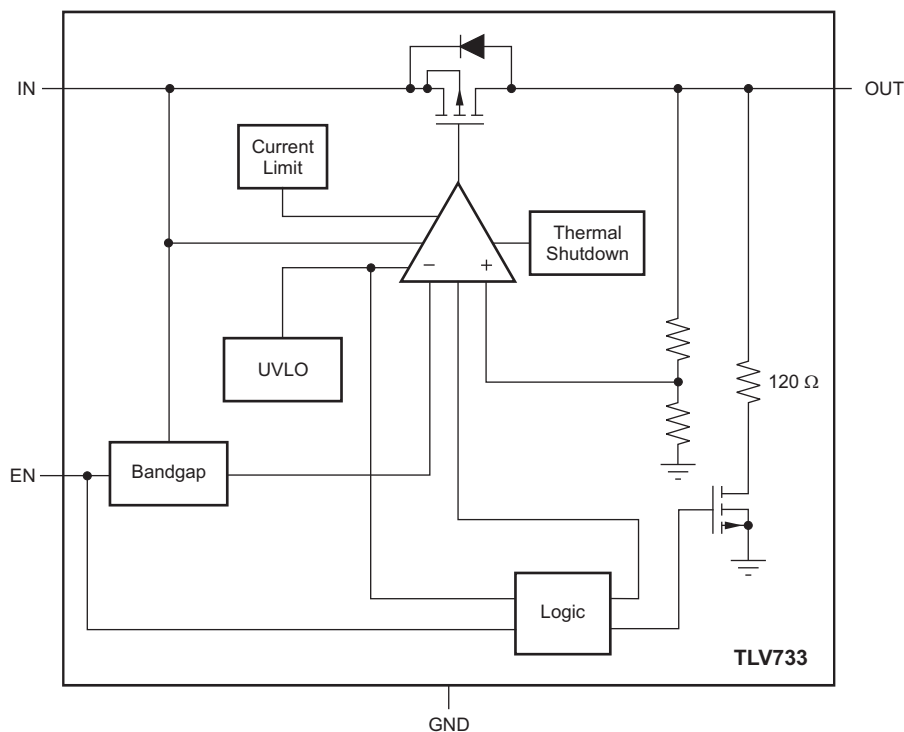

## 7.3 Feature Description

### 7.3.1 Undervoltage Lockout (UVLO)

The TLV733 uses an undervoltage lockout (UVLO) circuit that disables the output until the input voltage is greater than the rising UVLO voltage,  $UVLO_{RISE}$ . This circuit ensures that the device does not exhibit any unpredictable behavior when the supply voltage is lower than the operational range of the internal circuitry. During UVLO disable, the output is connected to ground with a 120- $\Omega$  pulldown resistor.

### 7.3.2 Shutdown and Output Enable

The enable pin (EN) is active high. Enable the device by forcing the EN pin to exceed  $V_{EN(HI)}$ . Turn off the device by forcing the EN pin to drop below  $V_{EN(LO)}$ . If shutdown capability is not required, connect EN to IN. There is no internal pulldown resistor connected to the EN pin.

The TLV733 has an internal pulldown MOSFET that connects a 120- $\Omega$  resistor to ground when the device is disabled. The discharge time after disabling depends on the output capacitance ( $C_{OUT}$ ) and the load resistance ( $R_L$ ) in parallel with the 120- $\Omega$  pulldown resistor. The time constant is calculated in [Equation 1](#):

$$\tau = \frac{120 \cdot R_L}{120 + R_L} \cdot C_{OUT} \quad (1)$$

### 7.3.3 Internal Foldback Current Limit

The TLV733 has an internal foldback current limit that protects the regulator during fault conditions. The current allowed through the device is reduced as the output voltage falls. When the output is shorted, the LDO supplies a typical current of 150 mA. The output voltage is not regulated when the device is in current limit. In this condition, the output voltage is the product of the regulated current and the load resistance. When the device output is shorted, the PMOS pass transistor dissipates power  $[(V_{IN} - V_{OUT}) \times I_{OS}]$  until thermal shutdown is triggered and the device turns off. After the device cools down, the internal thermal shutdown circuit turns the device back on. If the fault condition continues, the device cycles between current limit and thermal shutdown. See the [Thermal Information](#) table for more details.

The foldback current-limit circuit limits the current allowed through the device to current levels lower than the minimum current limit at nominal  $V_{OUT}$  current limit ( $I_{LIM}$ ) during startup. See [Figure 18](#) to [Figure 20](#) for typical foldback current limit values. If the output is loaded by a constant-current load during startup, or if the output voltage is negative when the device is enabled, then the load current demanded by the load may exceed the foldback current limit and the device may not rise to the full output voltage. For constant-current loads, disable the output load until the TLV733 has fully risen to its nominal output voltage.

The TLV733 PMOS pass element has an intrinsic body diode that conducts current when the voltage at the OUT pin exceeds the voltage at the IN pin. Do not force the output voltage to exceed the input voltage because excessively high current may flow through the body diode.

### 7.3.4 Thermal Shutdown

Thermal shutdown protection disables the output when the junction temperature rises to approximately 160°C. Disabling the device eliminates the power dissipated by the device, allowing the device to cool. When the junction temperature cools to approximately 140°C, the output circuitry is again enabled. Depending on power dissipation, thermal resistance, and ambient temperature, the thermal protection circuit may cycle on and off. This cycling limits regulator dissipation, protecting it from damage as a result of overheating.

Activating the thermal shutdown feature usually indicates excessive power dissipation as a result of the product of the  $(V_{IN} - V_{OUT})$  voltage and the load current. For reliable operation, limit junction temperature to 125°C maximum. To estimate the margin of safety in a complete design, increase the ambient temperature until the thermal protection is triggered; use worst-case loads and signal conditions.

The TLV733 internal protection circuitry protects against overload conditions but is not intended to be activated in normal operation. Continuously running the TLV733 into thermal shutdown degrades device reliability.

## 7.4 Device Functional Modes

### 7.4.1 Normal Operation

The device regulates to the nominal output voltage under the following conditions:

- The input voltage has previously exceeded the UVLO rising voltage and has not decreased below the UVLO falling threshold.
- The input voltage is greater than the nominal output voltage added to the dropout voltage.
- The enable voltage has previously exceeded the enable rising threshold voltage and not decreased below the enable falling threshold.
- The output current is less than the current limit.
- The device junction temperature is less than the thermal shutdown temperature.

### 7.4.2 Dropout Operation

If the input voltage is lower than the nominal output voltage plus the specified dropout voltage, but all other conditions are met for normal operation, the device operates in dropout mode. In this condition, the output voltage is the same the input voltage minus the dropout voltage. The transient performance of the device is significantly degraded because the pass device is in a triode state and no longer controls the current through the LDO. Line or load transients in dropout may result in large output voltage deviations.

### 7.4.3 Disabled

The device is disabled under the following conditions:

- The input voltage is less than the UVLO falling voltage, or has not yet exceeded the UVLO rising threshold.
- The enable voltage is less than the enable falling threshold voltage or has not yet exceeded the enable rising threshold.
- The device junction temperature is greater than the thermal shutdown temperature.

When the device is disabled, the active pulldown resistor discharges the output.

[Table 1](#) shows the conditions that lead to the different modes of operation.

**Table 1. Device Functional Mode Comparison**

OPERATING MODE	PARAMETER			
	$V_{IN}$	$V_{EN}$	$I_{OUT}$	$T_J$
Normal mode	$V_{IN} > V_{OUT(nom)} + V_{DO}$ and $V_{IN} > UVLO_{RISE}$	$V_{EN} > V_{EN(HI)}$	$I_{OUT} < I_{LIM}$	$T_J < 160^{\circ}C$
Dropout mode	$UVLO_{RISE} < V_{IN} < V_{OUT(nom)} + V_{DO}$	$V_{EN} > V_{EN(HI)}$	$I_{OUT} < I_{LIM}$	$T_J < 160^{\circ}C$
Disabled mode (any true condition disables the device)	$V_{IN} < UVLO_{FALL}$	$V_{EN} < V_{EN(LO)}$	—	$T_J > 160^{\circ}C$

## 8 Application and Implementation

### NOTE

Information in the following applications sections is not part of the TI component specification, and TI does not warrant its accuracy or completeness. TI's customers are responsible for determining suitability of components for their purposes. Customers should validate and test their design implementation to confirm system functionality.

### 8.1 Application Information

#### 8.1.1 Input and Output Capacitor Selection

The TLV733 uses an advanced internal control loop to obtain stable operation both with and without the use of input or output capacitors. Dynamic performance is improved with the use of an output capacitor, and may be improved with an input capacitor. An output capacitance of 0.1  $\mu\text{F}$  or larger generally provides good dynamic response. Use X5R- and X7R-type ceramic capacitors because these capacitors have minimal variation in value and equivalent series resistance (ESR) over temperature.

Although an input capacitor is not required for stability, increased output impedance from the input supply may compromise the performance of the TLV733. Good analog design practice is to connect a 0.1- $\mu\text{F}$  to 1- $\mu\text{F}$  capacitor from IN to GND. This capacitor counteracts reactive input sources and improves transient response, input ripple, and PSRR. Use an input capacitor if the source impedance is greater than 0.5  $\Omega$ . Use a higher-value capacitor if large, fast, rise-time load transients are anticipated, or if the device is located several inches from the input power source.

Figure 33 shows the transient performance improvements with an external 1- $\mu\text{F}$  capacitor on the output versus no output capacitor. The data in this figure are taken with an increasing load step from 50 mA to 300 mA, and the peak output voltage deviation (load transient response) is measured. For low output current slew rates, ( $< 0.1 \text{ A}/\mu\text{s}$ ), the transient performance of the device is similar with or without an output capacitor. As the current slew rate is increased, the peak voltage deviation is significantly increased. For loads that exhibit fast current slew rates above 0.1  $\text{A}/\mu\text{s}$ , use an output capacitor. For best performance, the maximum recommended output capacitance is 100  $\mu\text{F}$ .

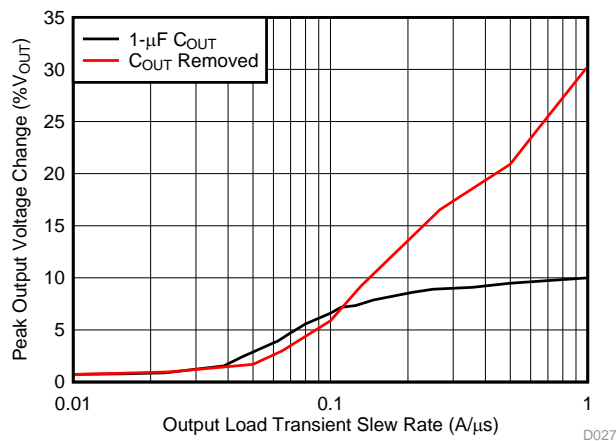

TLV73333PDBV, output current stepped from 50 mA to 300 mA, output voltage change measured at positive  $dl/dt$

**Figure 33. Output Voltage Deviation vs Load Step Slew Rate**

Some applications benefit from the removal of the output capacitor. In addition to space and cost savings, the removal of the output capacitor lowers inrush current as a result of eliminating the required current flow into the output capacitor upon startup. In these cases, take care to ensure that the load is tolerant of the additional output voltage deviations.



## Application Information (continued)

### 8.1.2 Dropout Voltage

The TLV733 uses a PMOS pass transistor to achieve low dropout. When  $(V_{IN} - V_{OUT})$  is less than the dropout voltage ( $V_{DO}$ ), the PMOS pass device is in the linear region of operation and the input-to-output resistance is the  $R_{DS(ON)}$  of the PMOS pass element.  $V_{DO}$  scales approximately with output current because the PMOS device behaves like a resistor in dropout mode. As with any linear regulator, PSRR and transient response degrade as  $(V_{IN} - V_{OUT})$  approaches dropout operation. See [Figure 7](#) to [Figure 12](#) for typical dropout values.

### 8.1.3 Power Dissipation

The ability to remove heat from the die is different for each package type, presenting different considerations in the printed circuit board (PCB) layout. The PCB area around the device that is free of other components moves the heat from the device to ambient air. Performance data for JEDEC high-K boards are given in the [Thermal Information](#) table. Using heavier copper increases the effectiveness in removing heat from the device. The addition of plated through-holes to heat-dissipating layers also improves heatsink effectiveness.

Power dissipation ( $P_D$ ) depends on input voltage and load conditions.  $P_D$  is equal to the product of the output current and voltage drop across the output pass element, as shown in [Equation 2](#).

$$P_D = (V_{IN} - V_{OUT}) \times I_{OUT} \quad (2)$$

[Figure 34](#) shows the maximum ambient temperature versus the power dissipation of the TLV733 in the DQN and DBV packages. This figure assumes the device is soldered on JEDEC standard high-K layout with no airflow over the board. Actual board thermal impedances vary widely. If the application requires high power dissipation, having a thorough understanding of the board temperature and thermal impedances is helpful to make sure the TLV733 does not operate continuously above a junction temperature of 125°C.

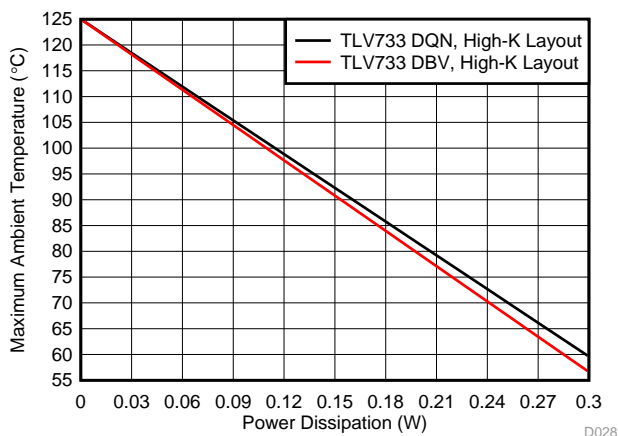

TLV733, high-K layout

**Figure 34. Maximum Ambient Temperature vs Device Power Dissipation**

## 8.2 Typical Applications

### 8.2.1 DC-DC Converter Post Regulation

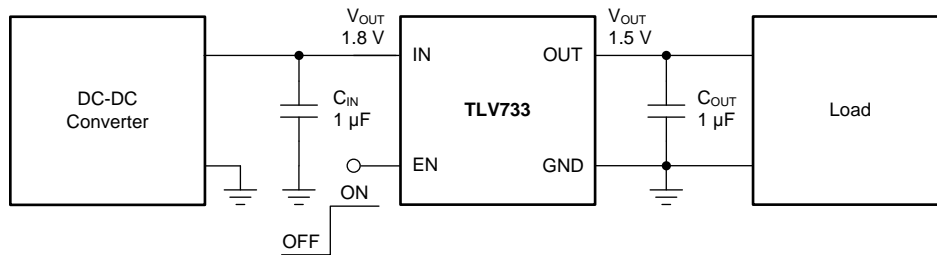

Figure 35. DC-DC Converter Post Regulation

#### 8.2.1.1 Design Requirements

Table 2. Design Parameters

PARAMETER	DESIGN REQUIREMENT
Input voltage	1.8 V, $\pm 5\%$
Output voltage	1.5 V, $\pm 1\%$
Output current	200-mA dc, 300-mA peak
Output voltage transient deviation	< 10%, 1-A/ $\mu$ s load step from 50 mA to 200 mA
Maximum ambient temperature	85°C

#### 8.2.1.2 Design Considerations

Input and output capacitors are required to achieve the output voltage transient requirements. Capacitance values of 1  $\mu$ F are selected to give the maximum output capacitance in a small, low-cost package.

Figure 7 shows the 1.2-V option dropout voltage. Given that dropout voltages are higher for lower output-voltage options, and given that the 1.2-V option dropout voltage is typically less than 300 mV at 125°C, then the 1.5-V option dropout voltage is typically less than 300 mV at 125°C.

Verify that the maximum junction temperature is not exceeded by referring to Figure 34.

#### 8.2.1.3 Application Curve

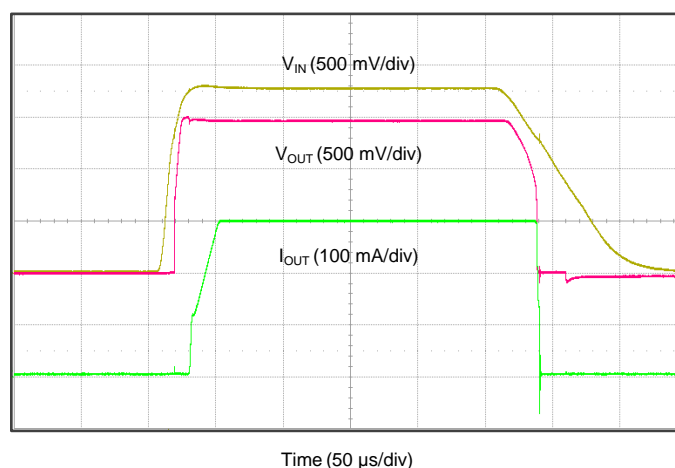

Figure 36. 1.8-V to 1.5-V Regulation at 300 mA

### 8.2.2 Capacitor-Free Operation from Battery Input Supply

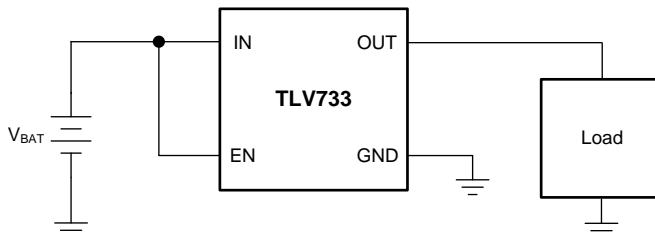

Figure 37. Capacitor-Free Operation from Battery Input Supply

#### 8.2.2.1 Design Requirements

Table 3. Design Parameters

PARAMETER	DESIGN REQUIREMENT
Input voltage	3.0 V to 1.8 V (two 1.5-V batteries)
Output voltage	1.0 V, ±1%
Input current	200 mA, maximum
Output load	100-mA dc
Maximum ambient temperature	70°C

#### 8.2.2.2 Design Considerations

An input capacitor is not required for this design because of the low impedance connection directly to the battery. No output capacitor allows for the minimal possible inrush current during startup, ensuring the 200-mA maximum input current is not exceeded.

Verify that the maximum junction temperature is not exceeded by referring to [Figure 34](#).

#### 8.2.2.3 Application Curve

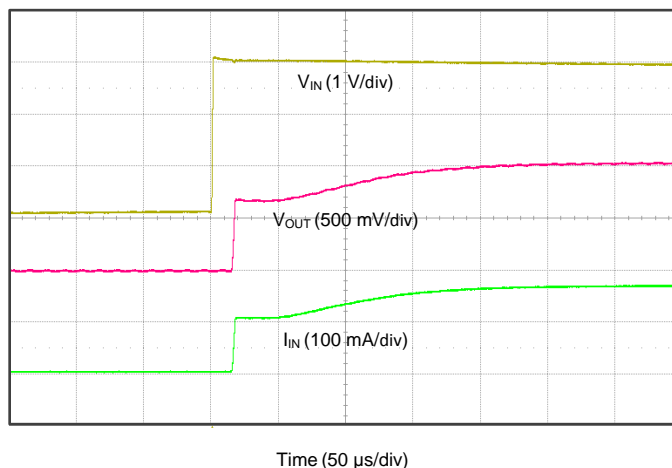

Figure 38. No Inrush Startup, 3.0-V to 1.0-V Regulation

## 9 Power Supply Recommendations

Connect a low output impedance power supply directly to the IN pin of the TLV733. Inductive impedances between the input supply and the IN pin can create significant voltage excursions at the IN pin during startup or load transient events. If inductive impedances are unavoidable, use an input capacitor.

## 10 Layout

### 10.1 Layout Guidelines

- Place input and output capacitors as close to the device as possible.
- Use copper planes for device connections, in order to optimize thermal performance.
- Place thermal vias around the device to distribute the heat.
- Do not place a thermal via directly beneath the thermal pad of the DQN package. A via can wick solder or solder paste away from the thermal pad joint during the soldering process, leading to a compromised solder joint on the thermal pad.

### 10.2 Layout Examples

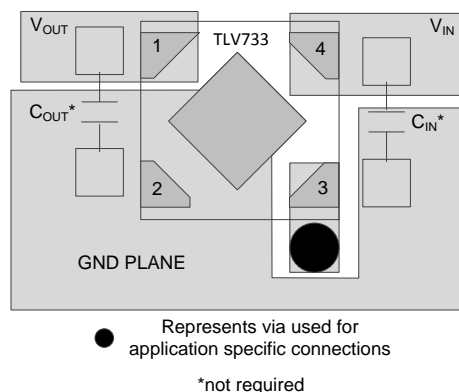

Figure 39. Layout Example for the DQN Package

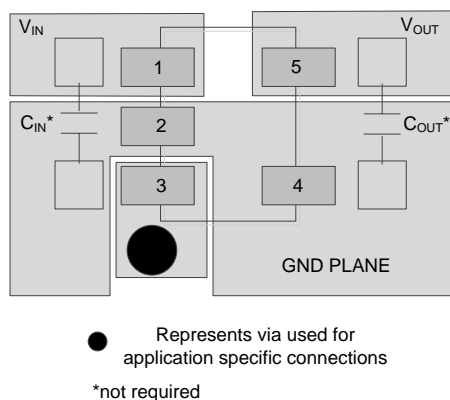

Figure 40. Layout Example for the DBV Package

## 11 Device and Documentation Support

### 11.1 Device Support

#### 11.1.1 Development Support

##### 11.1.1.1 Evaluation Module

An evaluation module (EVM) is available to assist in the initial circuit performance evaluation using the TLV733. The [TLV73312PEVM-643 evaluation module](#) (and [related user guide](#)) can be requested at the Texas Instruments website through the product folders or purchased directly from the [TI eStore](#).

#### 11.1.2 Device Nomenclature

**Table 4. Device Nomenclature<sup>(1)(2)</sup>**

PRODUCT	V <sub>OUT</sub>
TLV733xx(x)Pyyyz(3)	<p><b>xx(x)</b> is the nominal output voltage. For output voltages with a resolution of 100 mV, two digits are used in the ordering number; otherwise, three digits are used (for example, 28 = 2.8 V; 125 = 1.25 V).</p> <p><b>P</b> indicates an active output discharge feature. All members of the TLV733 family will actively discharge the output when the device is disabled.</p> <p><b>yyy</b> is the package designator.</p> <p><b>z</b> is the package quantity. R is for reel (3000 pieces), T is for tape (250 pieces).</p> <p><b>(3)</b> indicates an alternative tape and reel orientation. 3 indicates that pin 1 is in quadrant 3. See the Package Materials Information addendum for more information.</p>

- (1) For the most current package and ordering information see the Package Option Addendum at the end of this document, or visit the device product folder on [www.ti.com](http://www.ti.com).
- (2) Output voltages from 1.0 V to 3.3 V in 50-mV increments are available. Contact the factory for details and availability.

### 11.2 Documentation Support

#### 11.2.1 Related Documentation

Texas Instruments, [TLV73312PDQN-643 Evaluation Module user guide](#)

#### 11.3 Receiving Notification of Documentation Updates

To receive notification of documentation updates, navigate to the device product folder on [ti.com](http://ti.com). In the upper right corner, click on *Alert me* to register and receive a weekly digest of any product information that has changed. For change details, review the revision history included in any revised document.

#### 11.4 Community Resources

The following links connect to TI community resources. Linked contents are provided "AS IS" by the respective contributors. They do not constitute TI specifications and do not necessarily reflect TI's views; see TI's [Terms of Use](#).

**TI E2E™ Online Community** *TI's Engineer-to-Engineer (E2E) Community*. Created to foster collaboration among engineers. At [e2e.ti.com](http://e2e.ti.com), you can ask questions, share knowledge, explore ideas and help solve problems with fellow engineers.

**Design Support** *TI's Design Support* Quickly find helpful E2E forums along with design support tools and contact information for technical support.

#### 11.5 Trademarks

E2E is a trademark of Texas Instruments.  
All other trademarks are the property of their respective owners.

#### 11.6 Electrostatic Discharge Caution



This integrated circuit can be damaged by ESD. Texas Instruments recommends that all integrated circuits be handled with appropriate precautions. Failure to observe proper handling and installation procedures can cause damage.

ESD damage can range from subtle performance degradation to complete device failure. Precision integrated circuits may be more susceptible to damage because very small parametric changes could cause the device not to meet its published specifications.

## 11.7 Glossary

[SLYZ022](#) — *TI Glossary*.

This glossary lists and explains terms, acronyms, and definitions.

## 12 Mechanical, Packaging, and Orderable Information

The following pages include mechanical, packaging, and orderable information. This information is the most current data available for the designated devices. This data is subject to change without notice and revision of this document. For browser-based versions of this data sheet, refer to the left-hand navigation.

**PACKAGE OUTLINE**  
**X2SON - 0.4 mm max height**

**DQN0004A**

PLASTIC SMALL OUTLINE - NO LEAD

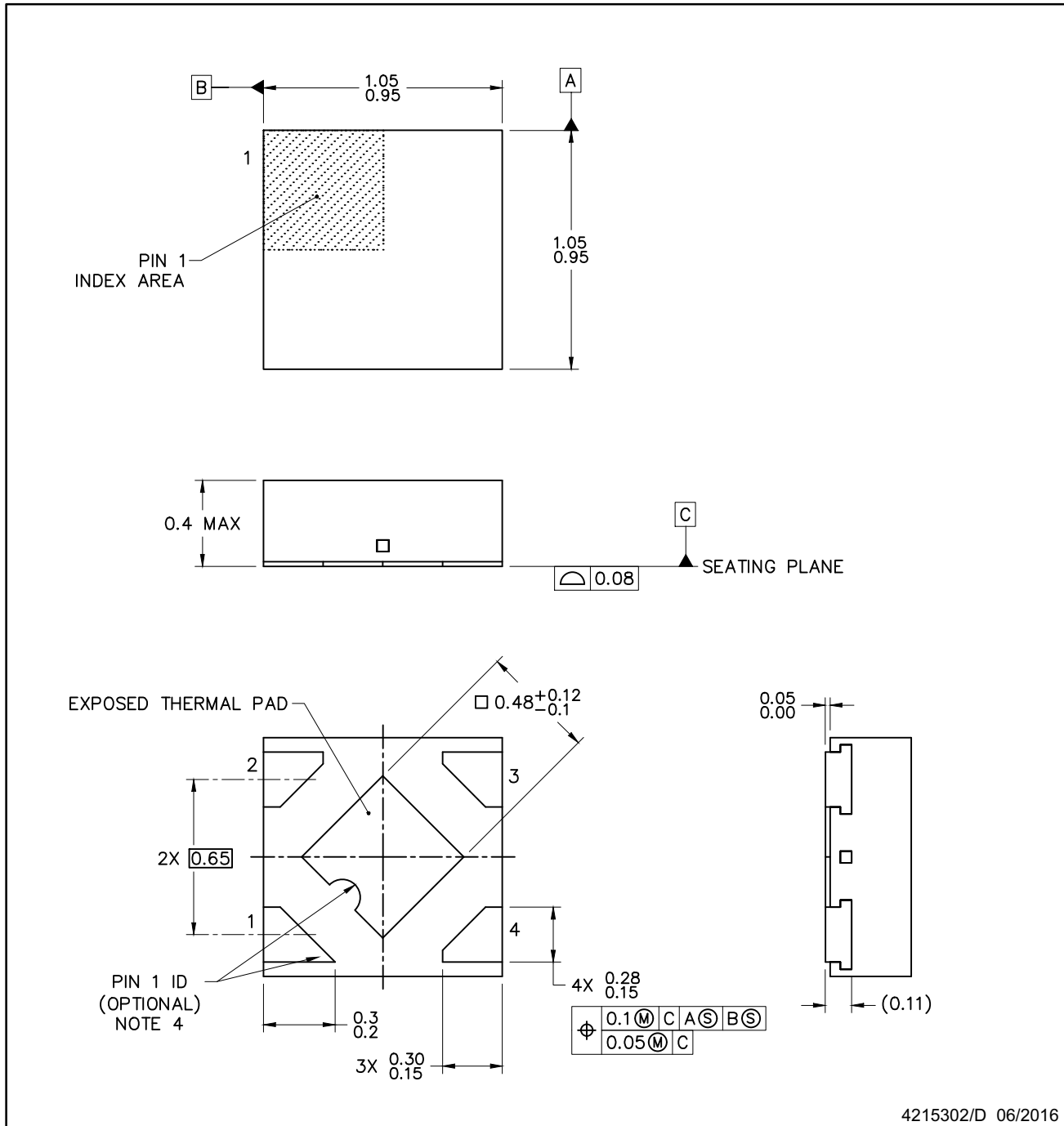

4215302/D 06/2016

NOTES:

1. All linear dimensions are in millimeters. Any dimensions in parenthesis are for reference only. Dimensioning and tolerancing per ASME Y14.5M.
2. This drawing is subject to change without notice.
3. The package thermal pad must be soldered to the printed circuit board for thermal and mechanical performance.
4. Features may not exist. Recommend use of pin 1 marking on top of package for orientation purposes.

EXAMPLE BOARD LAYOUT

DQN0004A

X2SON - 0.4 mm max height

PLASTIC SMALL OUTLINE - NO LEAD

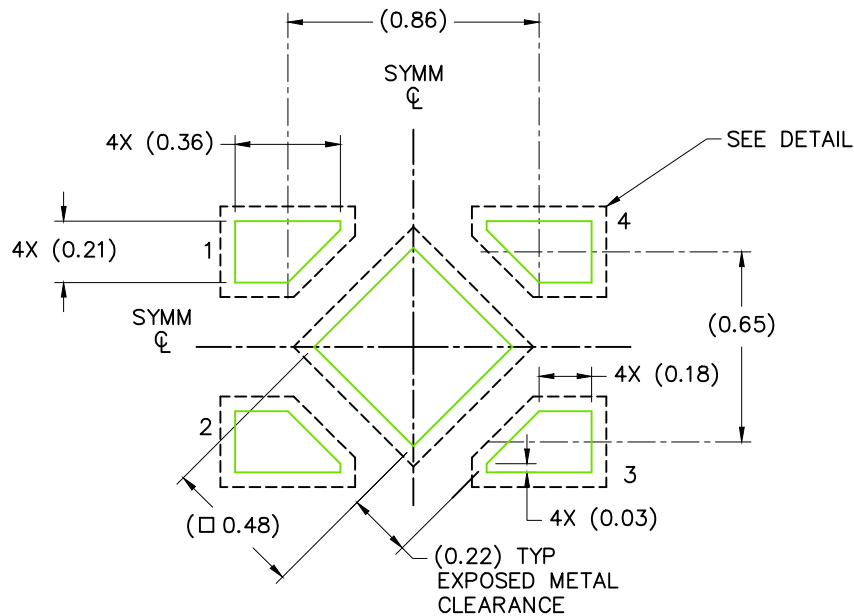

LAND PATTERN EXAMPLE  
SCALE: 40X

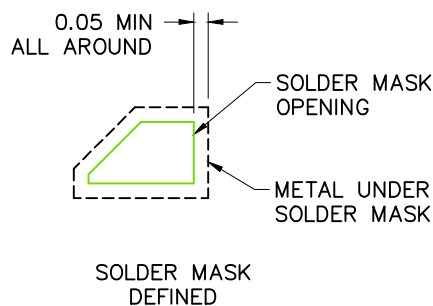

SOLDER MASK DEFINED  
SOLDER MASK DETAIL

4215302/D 06/2016

NOTES: (continued)

5. This package is designed to be soldered to a thermal pad on the board. For more information, see Texas Instruments literature number SLUA271 ([www.ti.com/lit/sluea271](http://www.ti.com/lit/sluea271)).
6. If any vias are implemented, it is recommended that vias under paste be filled, plugged or tented.



## EXAMPLE STENCIL DESIGN

DQN0004A

X2SON - 0.4 mm max height

PLASTIC SMALL OUTLINE - NO LEAD

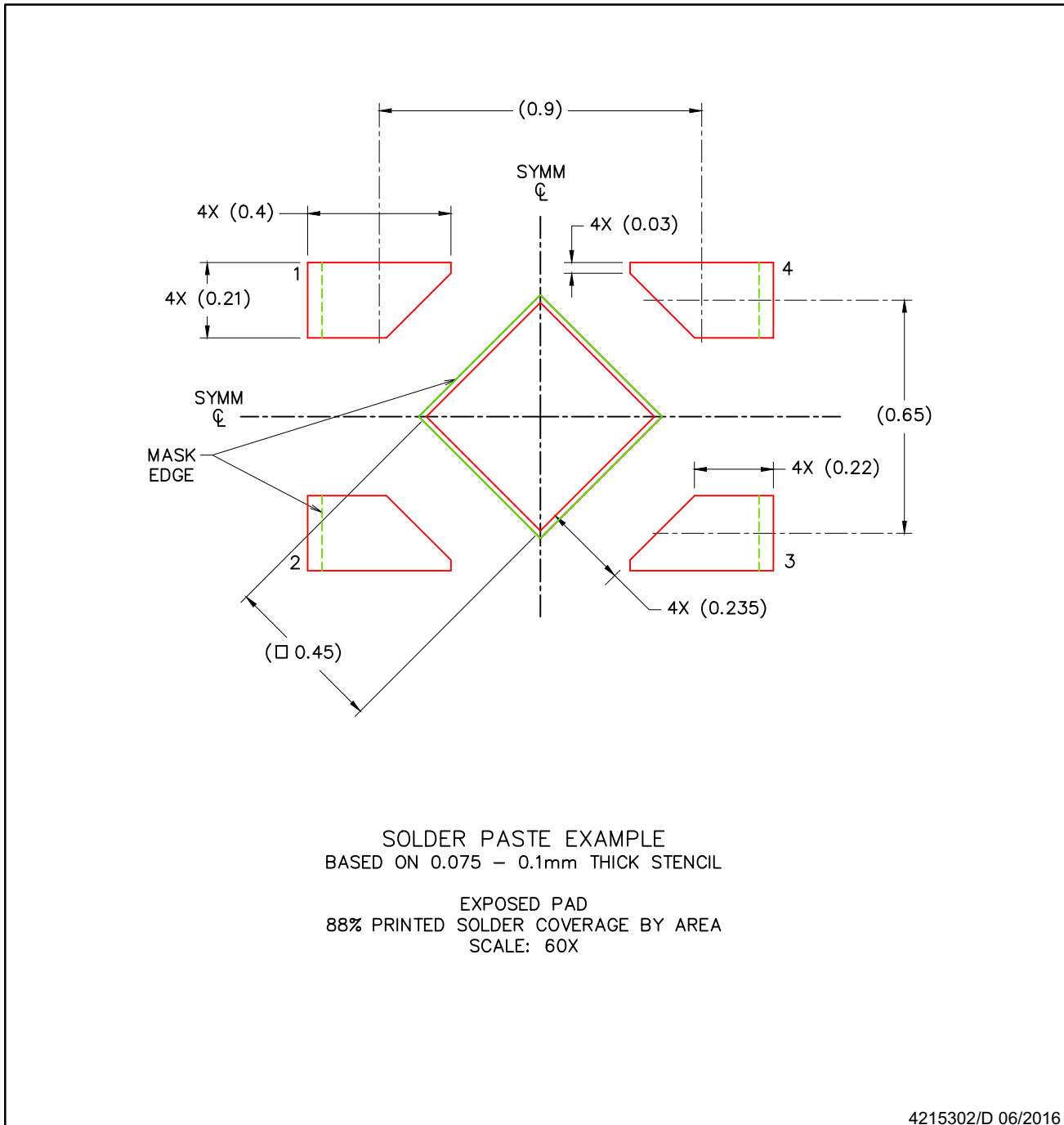

NOTES: (continued)

7. Laser cutting apertures with trapezoidal walls and rounded corners may offer better paste release. IPC-7525 may have alternate design recommendations.

**PACKAGING INFORMATION**

Orderable Device	Status (1)	Package Type	Package Drawing	Pins	Package Qty	Eco Plan (2)	Lead finish/ Ball material (6)	MSL Peak Temp (3)	Op Temp (°C)	Device Marking (4/5)	Samples
TLV73310PDBVR	ACTIVE	SOT-23	DBV	5	3000	RoHS & Green	NIPDAU   SN	Level-1-260C-UNLIM	-40 to 125	VCCQ	<a href="#">Samples</a>
TLV73310PDBVT	ACTIVE	SOT-23	DBV	5	250	RoHS & Green	NIPDAU   SN	Level-1-260C-UNLIM	-40 to 125	VCCQ	<a href="#">Samples</a>
TLV73310PDQNR	ACTIVE	X2SON	DQN	4	3000	RoHS & Green	NIPDAU	Level-1-260C-UNLIM	-40 to 125	FG	<a href="#">Samples</a>
TLV73310PDQNT	ACTIVE	X2SON	DQN	4	250	RoHS & Green	NIPDAU	Level-1-260C-UNLIM	-40 to 125	FG	<a href="#">Samples</a>
TLV73311PDBVR	ACTIVE	SOT-23	DBV	5	3000	RoHS & Green	NIPDAU   SN	Level-1-260C-UNLIM	-40 to 125	ZBLW	<a href="#">Samples</a>
TLV73311PDBVT	ACTIVE	SOT-23	DBV	5	250	RoHS & Green	NIPDAU   SN	Level-1-260C-UNLIM	-40 to 125	ZBLW	<a href="#">Samples</a>
TLV73311PDQNR	ACTIVE	X2SON	DQN	4	3000	RoHS & Green	NIPDAU	Level-1-260C-UNLIM	-40 to 125	GR	<a href="#">Samples</a>
TLV73311PDQNT	ACTIVE	X2SON	DQN	4	250	RoHS & Green	NIPDAU	Level-1-260C-UNLIM	-40 to 125	GR	<a href="#">Samples</a>
TLV73312PDBVR	ACTIVE	SOT-23	DBV	5	3000	RoHS & Green	NIPDAU   SN	Level-1-260C-UNLIM	-40 to 125	VCDQ	<a href="#">Samples</a>
TLV73312PDBVT	ACTIVE	SOT-23	DBV	5	250	RoHS & Green	NIPDAU   SN	Level-1-260C-UNLIM	-40 to 125	VCDQ	<a href="#">Samples</a>
TLV73312PDQNR	ACTIVE	X2SON	DQN	4	3000	RoHS & Green	NIPDAU	Level-1-260C-UNLIM	-40 to 125	FI	<a href="#">Samples</a>
TLV73312PDQNR3	ACTIVE	X2SON	DQN	4	3000	RoHS & Green	NIPDAU	Level-1-260C-UNLIM	-40 to 125	FI	<a href="#">Samples</a>
TLV73312PDQNT	ACTIVE	X2SON	DQN	4	250	RoHS & Green	NIPDAU	Level-1-260C-UNLIM	-40 to 125	FI	<a href="#">Samples</a>
TLV73315PDBVR	ACTIVE	SOT-23	DBV	5	3000	RoHS & Green	NIPDAU   SN	Level-1-260C-UNLIM	-40 to 125	VCFQ	<a href="#">Samples</a>
TLV73315PDBVT	ACTIVE	SOT-23	DBV	5	250	RoHS & Green	NIPDAU   SN	Level-1-260C-UNLIM	-40 to 125	VCFQ	<a href="#">Samples</a>
TLV73315PDQNR	ACTIVE	X2SON	DQN	4	3000	RoHS & Green	NIPDAU	Level-1-260C-UNLIM	-40 to 125	FJ	<a href="#">Samples</a>
TLV73315PDQNR3	ACTIVE	X2SON	DQN	4	3000	RoHS & Green	NIPDAU	Level-1-260C-UNLIM	-40 to 125	FJ	<a href="#">Samples</a>
TLV73315PDQNT	ACTIVE	X2SON	DQN	4	250	RoHS & Green	NIPDAU	Level-1-260C-UNLIM	-40 to 125	FJ	<a href="#">Samples</a>
TLV73318PDBVR	ACTIVE	SOT-23	DBV	5	3000	RoHS & Green	NIPDAU   SN	Level-1-260C-UNLIM	-40 to 125	VCGQ	<a href="#">Samples</a>
TLV73318PDBVT	ACTIVE	SOT-23	DBV	5	250	RoHS & Green	NIPDAU   SN	Level-1-260C-UNLIM	-40 to 125	VCGQ	<a href="#">Samples</a>

Orderable Device	Status (1)	Package Type	Package Drawing	Pins	Package Qty	Eco Plan (2)	Lead finish/ Ball material (6)	MSL Peak Temp (3)	Op Temp (°C)	Device Marking (4/5)	Samples
TLV73318PDQNR	ACTIVE	X2SON	DQN	4	3000	RoHS & Green	NIPDAU	Level-1-260C-UNLIM	-40 to 125	FK	<a href="#">Samples</a>
TLV73318PDQNR3	ACTIVE	X2SON	DQN	4	3000	RoHS & Green	NIPDAU	Level-1-260C-UNLIM	-40 to 125	FK	<a href="#">Samples</a>
TLV73318PDQNT	ACTIVE	X2SON	DQN	4	250	RoHS & Green	NIPDAU	Level-1-260C-UNLIM	-40 to 125	FK	<a href="#">Samples</a>
TLV73325PDBVR	ACTIVE	SOT-23	DBV	5	3000	RoHS & Green	NIPDAU   SN	Level-1-260C-UNLIM	-40 to 125	VCHQ	<a href="#">Samples</a>
TLV73325PDBVT	ACTIVE	SOT-23	DBV	5	250	RoHS & Green	NIPDAU   SN	Level-1-260C-UNLIM	-40 to 125	VCHQ	<a href="#">Samples</a>
TLV73325PDQNR	ACTIVE	X2SON	DQN	4	3000	RoHS & Green	NIPDAU	Level-1-260C-UNLIM	-40 to 125	FL	<a href="#">Samples</a>
TLV73325PDQNT	ACTIVE	X2SON	DQN	4	250	RoHS & Green	NIPDAU	Level-1-260C-UNLIM	-40 to 125	FL	<a href="#">Samples</a>
TLV733285PDBVR	ACTIVE	SOT-23	DBV	5	3000	RoHS & Green	NIPDAU   SN	Level-1-260C-UNLIM	-40 to 125	ZDRW	<a href="#">Samples</a>
TLV733285PDBVT	ACTIVE	SOT-23	DBV	5	250	RoHS & Green	NIPDAU   SN	Level-1-260C-UNLIM	-40 to 125	ZDRW	<a href="#">Samples</a>
TLV733285PDQNR	ACTIVE	X2SON	DQN	4	3000	RoHS & Green	NIPDAU	Level-1-260C-UNLIM	-40 to 125	GZ	<a href="#">Samples</a>
TLV733285PDQNT	ACTIVE	X2SON	DQN	4	250	RoHS & Green	NIPDAU	Level-1-260C-UNLIM	-40 to 125	GZ	<a href="#">Samples</a>
TLV73328PDBVR	ACTIVE	SOT-23	DBV	5	3000	RoHS & Green	NIPDAU   SN	Level-1-260C-UNLIM	-40 to 125	ZDQW	<a href="#">Samples</a>
TLV73328PDBVT	ACTIVE	SOT-23	DBV	5	250	RoHS & Green	NIPDAU   SN	Level-1-260C-UNLIM	-40 to 125	ZDQW	<a href="#">Samples</a>
TLV73328PDQNR	ACTIVE	X2SON	DQN	4	3000	RoHS & Green	NIPDAU	Level-1-260C-UNLIM	-40 to 125	GY	<a href="#">Samples</a>
TLV73328PDQNR3	ACTIVE	X2SON	DQN	4	3000	RoHS & Green	NIPDAU	Level-1-260C-UNLIM	-40 to 125	GY	<a href="#">Samples</a>
TLV73328PDQNT	ACTIVE	X2SON	DQN	4	250	RoHS & Green	NIPDAU	Level-1-260C-UNLIM	-40 to 125	GY	<a href="#">Samples</a>
TLV73330PDBVR	ACTIVE	SOT-23	DBV	5	3000	RoHS & Green	NIPDAU   SN	Level-1-260C-UNLIM	-40 to 125	ZDMW	<a href="#">Samples</a>
TLV73330PDBVT	ACTIVE	SOT-23	DBV	5	250	RoHS & Green	NIPDAU   SN	Level-1-260C-UNLIM	-40 to 125	ZDMW	<a href="#">Samples</a>
TLV73330PDQNR	ACTIVE	X2SON	DQN	4	3000	RoHS & Green	NIPDAU	Level-1-260C-UNLIM	-40 to 125	GW	<a href="#">Samples</a>
TLV73330PDQNT	ACTIVE	X2SON	DQN	4	250	RoHS & Green	NIPDAU	Level-1-260C-UNLIM	-40 to 125	GW	<a href="#">Samples</a>
TLV73333PDBVR	ACTIVE	SOT-23	DBV	5	3000	RoHS & Green	NIPDAU   SN	Level-1-260C-UNLIM	-40 to 125	VCIQ	<a href="#">Samples</a>

Orderable Device	Status (1)	Package Type	Package Drawing	Pins	Package Qty	Eco Plan (2)	Lead finish/ Ball material (6)	MSL Peak Temp (3)	Op Temp (°C)	Device Marking (4/5)	Samples
TLV73333PDBVT	ACTIVE	SOT-23	DBV	5	250	RoHS & Green	NIPDAU   SN	Level-1-260C-UNLIM	-40 to 125	VCIQ	<a href="#">Samples</a>
TLV73333PDQNR	ACTIVE	X2SON	DQN	4	3000	RoHS & Green	NIPDAU	Level-1-260C-UNLIM	-40 to 125	FM	<a href="#">Samples</a>
TLV73333PDQNT	ACTIVE	X2SON	DQN	4	250	RoHS & Green	NIPDAU	Level-1-260C-UNLIM	-40 to 125	FM	<a href="#">Samples</a>

(1) The marketing status values are defined as follows:

**ACTIVE:** Product device recommended for new designs.

**LIFEBUY:** TI has announced that the device will be discontinued, and a lifetime-buy period is in effect.

**NRND:** Not recommended for new designs. Device is in production to support existing customers, but TI does not recommend using this part in a new design.

**PREVIEW:** Device has been announced but is not in production. Samples may or may not be available.

**OBSELETE:** TI has discontinued the production of the device.

(2) **RoHS:** TI defines "RoHS" to mean semiconductor products that are compliant with the current EU RoHS requirements for all 10 RoHS substances, including the requirement that RoHS substance do not exceed 0.1% by weight in homogeneous materials. Where designed to be soldered at high temperatures, "RoHS" products are suitable for use in specified lead-free processes. TI may reference these types of products as "Pb-Free".

**RoHS Exempt:** TI defines "RoHS Exempt" to mean products that contain lead but are compliant with EU RoHS pursuant to a specific EU RoHS exemption.

**Green:** TI defines "Green" to mean the content of Chlorine (Cl) and Bromine (Br) based flame retardants meet JS709B low halogen requirements of <=1000ppm threshold. Antimony trioxide based flame retardants must also meet the <=1000ppm threshold requirement.

(3) MSL, Peak Temp. - The Moisture Sensitivity Level rating according to the JEDEC industry standard classifications, and peak solder temperature.

(4) There may be additional marking, which relates to the logo, the lot trace code information, or the environmental category on the device.

(5) Multiple Device Markings will be inside parentheses. Only one Device Marking contained in parentheses and separated by a "-" will appear on a device. If a line is indented then it is a continuation of the previous line and the two combined represent the entire Device Marking for that device.

(6) Lead finish/Ball material - Orderable Devices may have multiple material finish options. Finish options are separated by a vertical ruled line. Lead finish/Ball material values may wrap to two lines if the finish value exceeds the maximum column width.

**Important Information and Disclaimer:**The information provided on this page represents TI's knowledge and belief as of the date that it is provided. TI bases its knowledge and belief on information provided by third parties, and makes no representation or warranty as to the accuracy of such information. Efforts are underway to better integrate information from third parties. TI has taken and continues to take reasonable steps to provide representative and accurate information but may not have conducted destructive testing or chemical analysis on incoming materials and chemicals. TI and TI suppliers consider certain information to be proprietary, and thus CAS numbers and other limited information may not be available for release.

In no event shall TI's liability arising out of such information exceed the total purchase price of the TI part(s) at issue in this document sold by TI to Customer on an annual basis.

**OTHER QUALIFIED VERSIONS OF TLV733P :**

- Automotive : [TLV733P-Q1](#)

NOTE: Qualified Version Definitions:

- Automotive - Q100 devices qualified for high-reliability automotive applications targeting zero defects

**TAPE AND REEL INFORMATION**

**QUADRANT ASSIGNMENTS FOR PIN 1 ORIENTATION IN TAPE**

\*All dimensions are nominal

Device	Package Type	Package Drawing	Pins	SPQ	Reel Diameter (mm)	Reel Width W1 (mm)	A0 (mm)	B0 (mm)	K0 (mm)	P1 (mm)	W (mm)	Pin1 Quadrant
TLV73310PDBVR	SOT-23	DBV	5	3000	180.0	8.4	3.2	3.2	1.4	4.0	8.0	Q3
TLV73310PDBVT	SOT-23	DBV	5	250	180.0	8.4	3.2	3.2	1.4	4.0	8.0	Q3
TLV73310PDQNR	X2SON	DQN	4	3000	180.0	8.4	1.16	1.16	0.5	4.0	8.0	Q2
TLV73310PDQNT	X2SON	DQN	4	250	180.0	8.4	1.16	1.16	0.5	4.0	8.0	Q2
TLV73311PDBVR	SOT-23	DBV	5	3000	180.0	8.4	3.2	3.2	1.4	4.0	8.0	Q3
TLV73311PDBVT	SOT-23	DBV	5	250	180.0	8.4	3.2	3.2	1.4	4.0	8.0	Q3
TLV73311PDQNR	X2SON	DQN	4	3000	180.0	8.4	1.16	1.16	0.5	4.0	8.0	Q2
TLV73311PDQNT	X2SON	DQN	4	250	180.0	8.4	1.16	1.16	0.5	4.0	8.0	Q2
TLV73312PDBVR	SOT-23	DBV	5	3000	180.0	8.4	3.2	3.2	1.4	4.0	8.0	Q3
TLV73312PDBVT	SOT-23	DBV	5	250	180.0	8.4	3.2	3.2	1.4	4.0	8.0	Q3
TLV73312PDQNR	X2SON	DQN	4	3000	180.0	8.4	1.16	1.16	0.5	4.0	8.0	Q2
TLV73312PDQNR3	X2SON	DQN	4	3000	180.0	8.4	1.16	1.16	0.5	4.0	8.0	Q3
TLV73312PDQNT	X2SON	DQN	4	250	180.0	8.4	1.16	1.16	0.5	4.0	8.0	Q2
TLV73315PDBVR	SOT-23	DBV	5	3000	180.0	8.4	3.2	3.2	1.4	4.0	8.0	Q3
TLV73315PDBVT	SOT-23	DBV	5	250	180.0	8.4	3.2	3.2	1.4	4.0	8.0	Q3
TLV73315PDQNR	X2SON	DQN	4	3000	180.0	8.4	1.16	1.16	0.5	4.0	8.0	Q2

Device	Package Type	Package Drawing	Pins	SPQ	Reel Diameter (mm)	Reel Width W1 (mm)	A0 (mm)	B0 (mm)	K0 (mm)	P1 (mm)	W (mm)	Pin1 Quadrant
TLV73315PDQNR3	X2SON	DQN	4	3000	180.0	8.4	1.16	1.16	0.5	4.0	8.0	Q3
TLV73315PDQNT	X2SON	DQN	4	250	180.0	8.4	1.16	1.16	0.5	4.0	8.0	Q2
TLV73318PDBVR	SOT-23	DBV	5	3000	180.0	8.4	3.2	3.2	1.4	4.0	8.0	Q3
TLV73318PDBVT	SOT-23	DBV	5	250	180.0	8.4	3.2	3.2	1.4	4.0	8.0	Q3
TLV73318PDQNR	X2SON	DQN	4	3000	180.0	8.4	1.16	1.16	0.5	4.0	8.0	Q2
TLV73318PDQNR3	X2SON	DQN	4	3000	180.0	8.4	1.16	1.16	0.5	4.0	8.0	Q3
TLV73318PDQNT	X2SON	DQN	4	250	180.0	8.4	1.16	1.16	0.5	4.0	8.0	Q2
TLV73325PDBVR	SOT-23	DBV	5	3000	180.0	8.4	3.2	3.2	1.4	4.0	8.0	Q3
TLV73325PDBVT	SOT-23	DBV	5	250	180.0	8.4	3.2	3.2	1.4	4.0	8.0	Q3
TLV73325PDQNR	X2SON	DQN	4	3000	180.0	8.4	1.16	1.16	0.5	4.0	8.0	Q2
TLV73325PDQNT	X2SON	DQN	4	250	180.0	8.4	1.16	1.16	0.5	4.0	8.0	Q2
TLV733285PDBVR	SOT-23	DBV	5	3000	180.0	8.4	3.2	3.2	1.4	4.0	8.0	Q3
TLV733285PDBVT	SOT-23	DBV	5	250	180.0	8.4	3.2	3.2	1.4	4.0	8.0	Q3
TLV733285PDQNR	X2SON	DQN	4	3000	180.0	8.4	1.16	1.16	0.5	4.0	8.0	Q2
TLV733285PDQNT	X2SON	DQN	4	250	180.0	8.4	1.16	1.16	0.5	4.0	8.0	Q2
TLV73328PDBVR	SOT-23	DBV	5	3000	180.0	8.4	3.2	3.2	1.4	4.0	8.0	Q3
TLV73328PDBVT	SOT-23	DBV	5	250	180.0	8.4	3.2	3.2	1.4	4.0	8.0	Q3
TLV73328PDQNR	X2SON	DQN	4	3000	180.0	8.4	1.16	1.16	0.5	4.0	8.0	Q2
TLV73328PDQNR3	X2SON	DQN	4	3000	180.0	8.4	1.16	1.16	0.5	4.0	8.0	Q3
TLV73328PDQNT	X2SON	DQN	4	250	180.0	8.4	1.16	1.16	0.5	4.0	8.0	Q2
TLV73330PDBVR	SOT-23	DBV	5	3000	180.0	8.4	3.2	3.2	1.4	4.0	8.0	Q3
TLV73330PDBVT	SOT-23	DBV	5	250	180.0	8.4	3.2	3.2	1.4	4.0	8.0	Q3
TLV73330PDQNR	X2SON	DQN	4	3000	180.0	8.4	1.16	1.16	0.5	4.0	8.0	Q2
TLV73330PDQNT	X2SON	DQN	4	250	180.0	8.4	1.16	1.16	0.5	4.0	8.0	Q2
TLV73333PDBVR	SOT-23	DBV	5	3000	180.0	8.4	3.2	3.2	1.4	4.0	8.0	Q3
TLV73333PDBVT	SOT-23	DBV	5	250	180.0	8.4	3.2	3.2	1.4	4.0	8.0	Q3
TLV73333PDQNR	X2SON	DQN	4	3000	180.0	8.4	1.16	1.16	0.5	4.0	8.0	Q2
TLV73333PDQNT	X2SON	DQN	4	250	180.0	8.4	1.16	1.16	0.5	4.0	8.0	Q2

**TAPE AND REEL BOX DIMENSIONS**

\*All dimensions are nominal

Device	Package Type	Package Drawing	Pins	SPQ	Length (mm)	Width (mm)	Height (mm)
TLV73310PDBVR	SOT-23	DBV	5	3000	210.0	185.0	35.0
TLV73310PDBVT	SOT-23	DBV	5	250	210.0	185.0	35.0
TLV73310PDQNR	X2SON	DQN	4	3000	210.0	185.0	35.0
TLV73310PDQNT	X2SON	DQN	4	250	210.0	185.0	35.0
TLV73311PDBVR	SOT-23	DBV	5	3000	210.0	185.0	35.0
TLV73311PDBVT	SOT-23	DBV	5	250	210.0	185.0	35.0
TLV73311PDQNR	X2SON	DQN	4	3000	210.0	185.0	35.0
TLV73311PDQNT	X2SON	DQN	4	250	210.0	185.0	35.0
TLV73312PDBVR	SOT-23	DBV	5	3000	210.0	185.0	35.0
TLV73312PDBVT	SOT-23	DBV	5	250	210.0	185.0	35.0
TLV73312PDQNR	X2SON	DQN	4	3000	210.0	185.0	35.0
TLV73312PDQNR3	X2SON	DQN	4	3000	210.0	185.0	35.0
TLV73312PDQNT	X2SON	DQN	4	250	210.0	185.0	35.0
TLV73315PDBVR	SOT-23	DBV	5	3000	210.0	185.0	35.0
TLV73315PDBVT	SOT-23	DBV	5	250	210.0	185.0	35.0
TLV73315PDQNR	X2SON	DQN	4	3000	210.0	185.0	35.0
TLV73315PDQNR3	X2SON	DQN	4	3000	210.0	185.0	35.0
TLV73315PDQNT	X2SON	DQN	4	250	210.0	185.0	35.0



Device	Package Type	Package Drawing	Pins	SPQ	Length (mm)	Width (mm)	Height (mm)
TLV73318PDBVR	SOT-23	DBV	5	3000	210.0	185.0	35.0
TLV73318PDBVT	SOT-23	DBV	5	250	210.0	185.0	35.0
TLV73318PDQNR	X2SON	DQN	4	3000	210.0	185.0	35.0
TLV73318PDQNR3	X2SON	DQN	4	3000	210.0	185.0	35.0
TLV73318PDQNT	X2SON	DQN	4	250	210.0	185.0	35.0
TLV73325PDBVR	SOT-23	DBV	5	3000	210.0	185.0	35.0
TLV73325PDBVT	SOT-23	DBV	5	250	210.0	185.0	35.0
TLV73325PDQNR	X2SON	DQN	4	3000	210.0	185.0	35.0
TLV73325PDQNT	X2SON	DQN	4	250	210.0	185.0	35.0
TLV733285PDBVR	SOT-23	DBV	5	3000	210.0	185.0	35.0
TLV733285PDBVT	SOT-23	DBV	5	250	210.0	185.0	35.0
TLV733285PDQNR	X2SON	DQN	4	3000	210.0	185.0	35.0
TLV733285PDQNT	X2SON	DQN	4	250	210.0	185.0	35.0
TLV73328PDBVR	SOT-23	DBV	5	3000	210.0	185.0	35.0
TLV73328PDBVT	SOT-23	DBV	5	250	210.0	185.0	35.0
TLV73328PDQNR	X2SON	DQN	4	3000	210.0	185.0	35.0
TLV73328PDQNR3	X2SON	DQN	4	3000	210.0	185.0	35.0
TLV73328PDQNT	X2SON	DQN	4	250	210.0	185.0	35.0
TLV73330PDBVR	SOT-23	DBV	5	3000	210.0	185.0	35.0
TLV73330PDBVT	SOT-23	DBV	5	250	210.0	185.0	35.0
TLV73330PDQNR	X2SON	DQN	4	3000	210.0	185.0	35.0
TLV73330PDQNT	X2SON	DQN	4	250	210.0	185.0	35.0
TLV73333PDBVR	SOT-23	DBV	5	3000	210.0	185.0	35.0
TLV73333PDBVT	SOT-23	DBV	5	250	210.0	185.0	35.0
TLV73333PDQNR	X2SON	DQN	4	3000	210.0	185.0	35.0
TLV73333PDQNT	X2SON	DQN	4	250	210.0	185.0	35.0

# DBV0005A



## PACKAGE OUTLINE

SOT-23 - 1.45 mm max height

SMALL OUTLINE TRANSISTOR

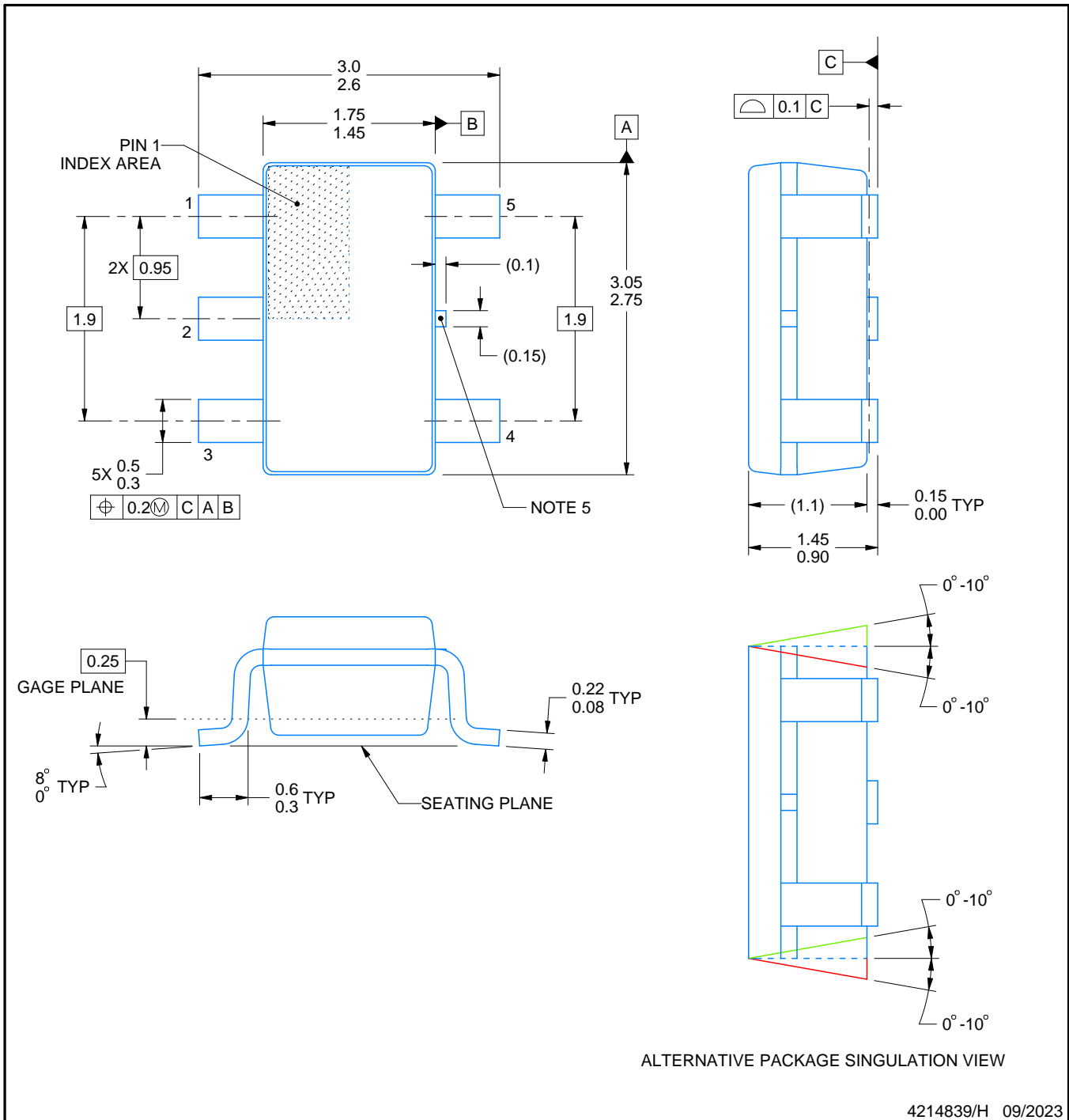

### NOTES:

1. All linear dimensions are in millimeters. Any dimensions in parenthesis are for reference only. Dimensioning and tolerancing per ASME Y14.5M.
2. This drawing is subject to change without notice.
3. Reference JEDEC MO-178.
4. Body dimensions do not include mold flash, protrusions, or gate burrs. Mold flash, protrusions, or gate burrs shall not exceed 0.25 mm per side.
5. Support pin may differ or may not be present.

# EXAMPLE BOARD LAYOUT

DBV0005A

SOT-23 - 1.45 mm max height

SMALL OUTLINE TRANSISTOR



LAND PATTERN EXAMPLE  
EXPOSED METAL SHOWN  
SCALE:15X

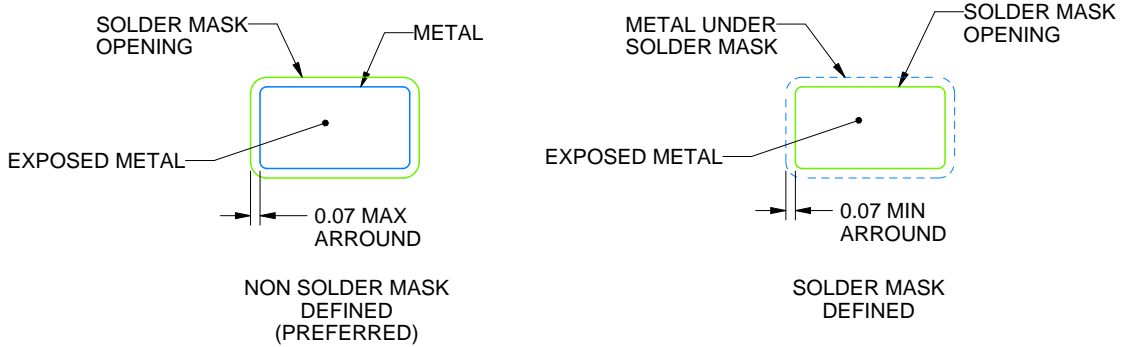

SOLDER MASK DETAILS

4214839/H 09/2023

NOTES: (continued)

6. Publication IPC-7351 may have alternate designs.

7. Solder mask tolerances between and around signal pads can vary based on board fabrication site.

# EXAMPLE STENCIL DESIGN

DBV0005A

SOT-23 - 1.45 mm max height

SMALL OUTLINE TRANSISTOR



SOLDER PASTE EXAMPLE  
BASED ON 0.125 mm THICK STENCIL  
SCALE:15X

4214839/H 09/2023

NOTES: (continued)

8. Laser cutting apertures with trapezoidal walls and rounded corners may offer better paste release. IPC-7525 may have alternate design recommendations.
9. Board assembly site may have different recommendations for stencil design.

## IMPORTANT NOTICE AND DISCLAIMER

TI PROVIDES TECHNICAL AND RELIABILITY DATA (INCLUDING DATA SHEETS), DESIGN RESOURCES (INCLUDING REFERENCE DESIGNS), APPLICATION OR OTHER DESIGN ADVICE, WEB TOOLS, SAFETY INFORMATION, AND OTHER RESOURCES "AS IS" AND WITH ALL FAULTS, AND DISCLAIMS ALL WARRANTIES, EXPRESS AND IMPLIED, INCLUDING WITHOUT LIMITATION ANY IMPLIED WARRANTIES OF MERCHANTABILITY, FITNESS FOR A PARTICULAR PURPOSE OR NON-INFRINGEMENT OF THIRD PARTY INTELLECTUAL PROPERTY RIGHTS.

These resources are intended for skilled developers designing with TI products. You are solely responsible for (1) selecting the appropriate TI products for your application, (2) designing, validating and testing your application, and (3) ensuring your application meets applicable standards, and any other safety, security, regulatory or other requirements.

These resources are subject to change without notice. TI grants you permission to use these resources only for development of an application that uses the TI products described in the resource. Other reproduction and display of these resources is prohibited. No license is granted to any other TI intellectual property right or to any third party intellectual property right. TI disclaims responsibility for, and you will fully indemnify TI and its representatives against, any claims, damages, costs, losses, and liabilities arising out of your use of these resources.

TI's products are provided subject to [TI's Terms of Sale](#) or other applicable terms available either on [ti.com](https://www.ti.com) or provided in conjunction with such TI products. TI's provision of these resources does not expand or otherwise alter TI's applicable warranties or warranty disclaimers for TI products.

TI objects to and rejects any additional or different terms you may have proposed.

Mailing Address: Texas Instruments, Post Office Box 655303, Dallas, Texas 75265  
Copyright © 2023, Texas Instruments Incorporated

单击下面可查看定价，库存，交付和生命周期等信息

[>>TI\(德州仪器\)](#)