

CC1310 SimpleLink™ Ultra-Low-Power Sub-1 GHz Wireless MCU

1 Device Overview

1.1 Features

- Microcontroller
 - Powerful Arm® Cortex®-M3 Processor
 - EEMBC CoreMark® Score: 142
 - EEMBC ULPBench™ Score: 158
 - Clock Speed up to 48-MHz
 - 32KB, 64KB, and 128KB of In-System Programmable Flash
 - 8KB of SRAM for Cache (or as General-Purpose RAM)
 - 20KB of Ultra-Low-Leakage SRAM
 - 2-Pin cJTAG and JTAG Debugging
 - Supports Over-the-Air (OTA) Update
- Ultra-Low-Power Sensor Controller
 - Can Run Autonomously From the Rest of the System
 - 16-Bit Architecture
 - 2KB of Ultra-Low-Leakage SRAM for Code and Data
- Efficient Code-Size Architecture, Placing Parts of TI-RTOS, Drivers, and Bootloader in ROM
- RoHS-Compliant Package
 - 7-mm x 7-mm RGZ VQFN48 (30 GPIOs)
 - 5-mm x 5-mm RHB VQFN32 (15 GPIOs)
 - 4-mm x 4-mm RSM VQFN32 (10 GPIOs)
- Peripherals
 - All Digital Peripheral Pins Can Be Routed to Any GPIO
 - Four General-Purpose Timer Modules (Eight 16-Bit or Four 32-Bit Timers, PWM Each)
 - 12-Bit ADC, 200 ksamples/s, 8-Channel Analog MUX
 - Continuous Time Comparator
 - Ultra-Low-Power Clocked Comparator
 - Programmable Current Source
 - UART
 - 2x SSI (SPI, MICROWIRE, TI)
 - I²C, I2S
 - Real-Time Clock (RTC)
 - AES-128 Security Module
 - True Random Number Generator (TRNG)
 - Support for Eight Capacitive Sensing Buttons
 - Integrated Temperature Sensor
- External System
 - On-Chip Internal DC/DC Converter
 - Seamless Integration With the SimpleLink™ CC1190 Range Extender
- Low Power
 - Wide Supply Voltage Range: 1.8 to 3.8 V
 - RX: 5.4 mA
 - TX at +10 dBm: 13.4 mA
 - Active-Mode MCU 48 MHz Running Coremark: 2.5 mA (51 µA/MHz)
 - Active-Mode MCU: 48.5 CoreMark/mA
 - Active-Mode Sensor Controller at 24 MHz: 0.4 mA + 8.2 µA/MHz
 - Sensor Controller, One Wakeup Every Second Performing One 12-Bit ADC Sampling: 0.95 µA
 - Standby: 0.7 µA (RTC Running and RAM and CPU Retention)
 - Shutdown: 185 nA (Wakeup on External Events)
- RF Section
 - Excellent Receiver Sensitivity –124 dBm Using Long-Range Mode, –110 dBm at 50 kbps
 - Excellent Selectivity (±100 kHz): 56 dB
 - Excellent Blocking Performance (±10 MHz): 90 dB
 - Programmable Output Power up to +15 dBm
 - Single-Ended or Differential RF Interface
 - Suitable for Systems Targeting Compliance With Worldwide Radio Frequency Regulations
 - ETSI EN 300 220, EN 303 204 (Europe)
 - FCC CFR47 Part 15 (US)
 - ARIB STD-T108 (Japan)
 - Wireless M-Bus (EN 13757-4) and IEEE® 802.15.4g PHY
- Tools and Development Environment
 - Full-Feature and Low-Cost Development Kits
 - Multiple Reference Designs for Different RF Configurations
 - Packet Sniffer PC Software
 - Sensor Controller Studio
 - SmartRF™ Studio
 - SmartRF Flash Programmer 2
 - IAR Embedded Workbench® for Arm
 - Code Composer Studio™ (CCS) IDE
 - CCS UniFlash



1.2 Applications

- 315-, 433-, 470-, 500-, 779-, 868-, 915-, 920-MHz ISM and SRD Systems
- Low-Power Wireless Systems With 50-kHz to 5-MHz Channel Spacing
- Home and Building Automation
- Wireless Alarm and Security Systems
- Industrial Monitoring and Control
- Smart Grid and Automatic Meter Reading
- Wireless Healthcare Applications
- Wireless Sensor Networks
- Active RFID
- IEEE 802.15.4g, IP-Enabled Smart Objects (6LoWPAN), Wireless M-Bus, KNX Systems, Wi-SUN™, and Proprietary Systems
- Energy-Harvesting Applications
- Electronic Shelf Label (ESL)
- Long-Range Sensor Applications
- Heat-Cost Allocators

1.3 Description

The CC1310 device is a cost-effective, ultra-low-power, Sub-1 GHz RF device from Texas Instruments™ that is part of the SimpleLink™ microcontroller (MCU) platform. The platform consists of Wi-Fi®, Bluetooth® low energy, Sub-1 GHz, Ethernet, Zigbee®, Thread, and host MCUs. These devices all share a common, easy-to-use development environment with a single core software development kit (SDK) and a rich tool set. A one-time integration of the SimpleLink platform enables users to add any combination of devices from the portfolio into their design, allowing 100 percent code reuse when design requirements change. For more information, visit www.ti.com/simplelink.

With very low active RF and MCU current consumption, in addition to flexible low-power modes, the CC1310 device provides excellent battery life and allows long-range operation on small coin-cell batteries and in energy harvesting applications.

The CC1310 is a device in the CC13xx and CC26xx family of cost-effective, ultra-low-power wireless MCUs capable of handling Sub-1 GHz RF frequencies. The CC1310 device combines a flexible, very low-power RF transceiver with a powerful 48-MHz Arm® Cortex®-M3 microcontroller in a platform supporting multiple physical layers and RF standards. A dedicated Radio Controller (Cortex®-M0) handles low-level RF protocol commands that are stored in ROM or RAM, thus ensuring ultra-low power and flexibility. The low-power consumption of the CC1310 device does not come at the expense of RF performance; the CC1310 device has excellent sensitivity and robustness (selectivity and blocking) performance.

The CC1310 device is a highly integrated, true single-chip solution incorporating a complete RF system and an on-chip DC/DC converter.

Sensors can be handled in a very low-power manner by a dedicated autonomous ultra-low-power MCU that can be configured to handle analog and digital sensors; thus the main MCU (Arm® Cortex®-M3) can maximize sleep time.

The power and clock management and radio systems of the CC1310 device require specific configuration and handling by software to operate correctly, which has been implemented in the TI-RTOS. TI recommends using this software framework for all application development on the device. The complete [TI-RTOS](#) and device drivers are offered free of charge in source code.

Device Information⁽¹⁾

| PART NUMBER | PACKAGE | BODY SIZE (NOM) |
|---------------|-----------|-------------------|
| CC1310F128RGZ | VQFN (48) | 7.00 mm × 7.00 mm |
| CC1310F128RHB | VQFN (32) | 5.00 mm × 5.00 mm |
| CC1310F128RSM | VQFN (32) | 4.00 mm × 4.00 mm |
| CC1310F64RGZ | VQFN (48) | 7.00 mm × 7.00 mm |
| CC1310F64RHB | VQFN (32) | 5.00 mm × 5.00 mm |
| CC1310F64RSM | VQFN (32) | 4.00 mm × 4.00 mm |
| CC1310F32RGZ | VQFN (48) | 7.00 mm × 7.00 mm |
| CC1310F32RHB | VQFN (32) | 5.00 mm × 5.00 mm |
| CC1310F32RSM | VQFN (32) | 4.00 mm × 4.00 mm |

(1) For more information, see [Section 9](#).

1.4 Functional Block Diagram

Figure 1-1 shows a block diagram for the CC1310 device.

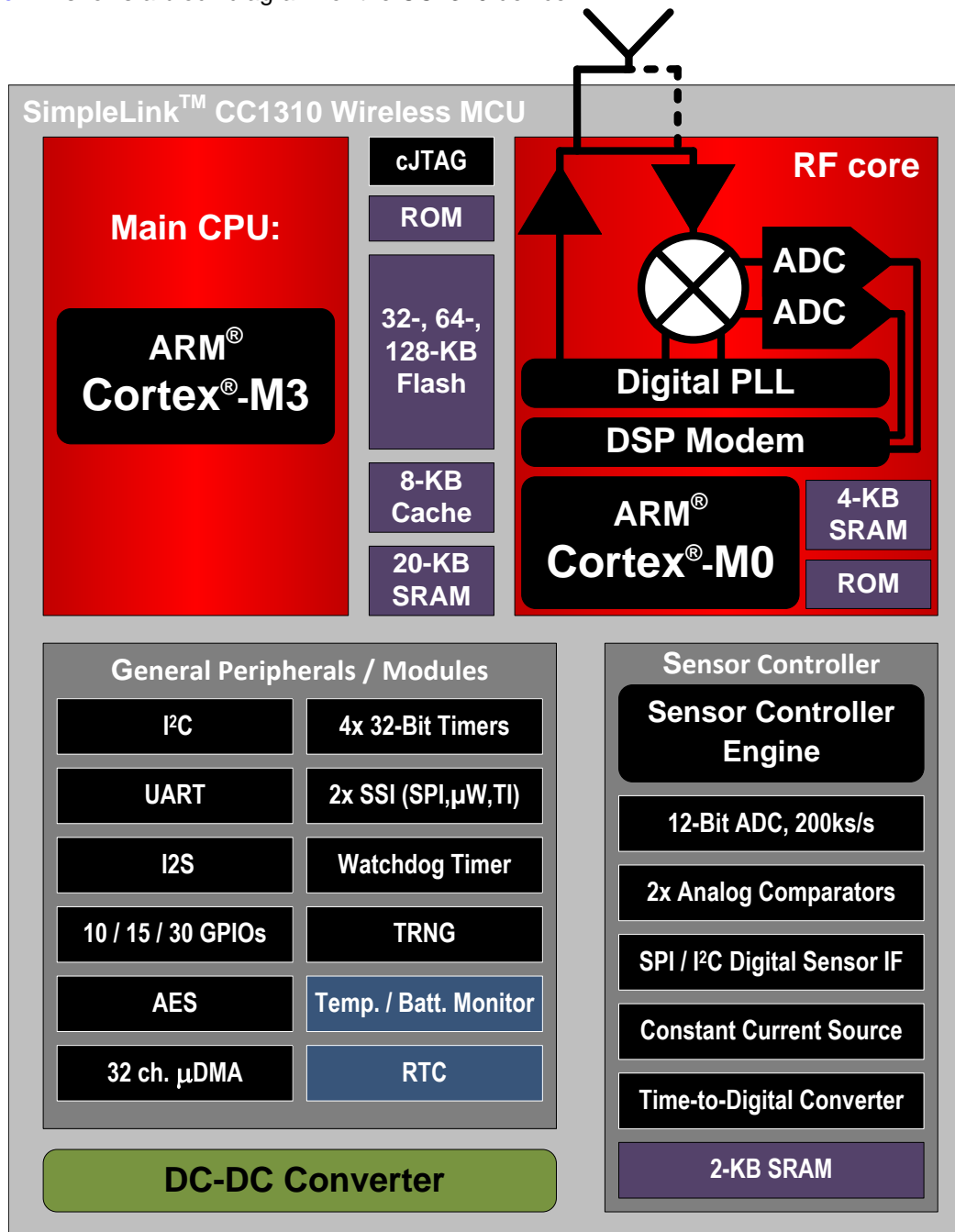

Copyright © 2016, Texas Instruments Incorporated

Figure 1-1. CC1310 Block Diagram

Table of Contents

| | |
|--|--|
| 1 Device Overview 1 | |
| 1.1 Features 1 | 5.17 DC Characteristics 29 |
| 1.2 Applications 2 | 5.18 Thermal Characteristics 30 |
| 1.3 Description 2 | 5.19 Timing and Switching Characteristics 30 |
| 1.4 Functional Block Diagram 4 | 5.20 Typical Characteristics 34 |
| 2 Revision History 6 | 6 Detailed Description 38 |
| 3 Device Comparison 7 | 6.1 Overview 38 |
| 3.1 Related Products 7 | 6.2 Main CPU 38 |
| 4 Terminal Configuration and Functions 8 | 6.3 RF Core 39 |
| 4.1 Pin Diagram – RSM Package 8 | 6.4 Sensor Controller 40 |
| 4.2 Signal Descriptions – RSM Package 9 | 6.5 Memory 41 |
| 4.3 Pin Diagram – RHB Package 10 | 6.6 Debug 41 |
| 4.4 Signal Descriptions – RHB Package 11 | 6.7 Power Management 42 |
| 4.5 Pin Diagram – RGZ Package 12 | 6.8 Clock Systems 43 |
| 4.6 Signal Descriptions – RGZ Package 13 | 6.9 General Peripherals and Modules 43 |
| 5 Specifications 15 | 6.10 Voltage Supply Domains 44 |
| 5.1 Absolute Maximum Ratings 15 | 6.11 System Architecture 44 |
| 5.2 ESD Ratings 15 | 7 Application, Implementation, and Layout 45 |
| 5.3 Recommended Operating Conditions 15 | 7.1 Application Information 45 |
| 5.4 Power Consumption Summary 16 | 7.2 TI Design or Reference Design 46 |
| 5.5 RF Characteristics 16 | 8 Device and Documentation Support 47 |
| 5.6 Receive (RX) Parameters, 861 MHz to 1054 MHz . 17 | 8.1 Device Nomenclature 47 |
| 5.7 Receive (RX) Parameters, 431 MHz to 527 MHz .. 23 | 8.2 Tools and Software 48 |
| 5.8 Transmit (TX) Parameters, 861 MHz to 1054 MHz . 25 | 8.3 Documentation Support 50 |
| 5.9 Transmit (TX) Parameters, 431 MHz to 527 MHz .. 26 | 8.4 Texas Instruments Low-Power RF Website 50 |
| 5.10 PLL Parameters 26 | 8.5 Additional Information 50 |
| 5.11 ADC Characteristics 26 | 8.6 Community Resources 50 |
| 5.12 Temperature Sensor 28 | 8.7 Trademarks 51 |
| 5.13 Battery Monitor 28 | 8.8 Electrostatic Discharge Caution 51 |
| 5.14 Continuous Time Comparator 28 | 8.9 Export Control Notice 51 |
| 5.15 Low-Power Clocked Comparator 28 | 8.10 Glossary 51 |
| 5.16 Programmable Current Source 29 | 9 Mechanical, Packaging, and Orderable Information 51 |
| | 9.1 Packaging Information 51 |

2 Revision History

NOTE: Page numbers for previous revisions may differ from page numbers in the current version.

| Changes from October 27, 2016 to July 13, 2018 | Page |
|--|--------------------|
| • Added Code Composer Studio UniFlash | 1 |
| • Changed <i>Description</i> section | 2 |
| • Changed Table 3-1 | 7 |
| • Changed Figure 4-1 | 8 |
| • Changed Figure 4-2 | 10 |
| • Added support for split supply rail to Section 5.3 | 15 |
| • Changed Operating supply voltage | 15 |
| • Added test conditions at 433.92 MHz to Section 5.4 | 16 |
| • Moved footnote to specific values in Section 5.5 | 16 |
| • Changed footnote in Section 5.5 | 16 |
| • Changed test conditions for Receiver sensitivity, 50 kbps in Section 5.6 | 17 |
| • Added parameters to Section 5.6 | 17 |
| • Added Receiver sensitivity parameters to Section 5.7 | 23 |
| • Changed | 31 |
| • Changed footnote in | 31 |
| • Added Software section | 48 |

| Changes from October 28, 2015 to October 27, 2016 | Page |
|--|--------------------|
| • Added 32KB and 64KB to the <i>Features</i> bullet for in-system programmable flash | 1 |
| • Changed to the correct pin count in the <i>Features</i> bullet <i>RoHS-Compliant Package</i> | 1 |
| • Changed CC1310 Block Diagram | 4 |
| • Changed Figure 4-2 , corrected typo in pin name | 10 |
| • Changed the table note in Section 5.1 from: VDD5 to: ground | 15 |
| • Changed ESD ratings for all pins in Section 5.2 | 15 |
| • Added OOK modulation power consumption to Section 5.4 | 16 |
| • Added OOK modulation sensitivity to Section 5.6 | 22 |
| • Added receive parameters for 431-MHz to 527-MHz band in Section 5.7 | 23 |
| • Added transmit parameters for 431-MHz to 527-MHz band in Section 5.9 | 26 |
| • Changed ADC reference voltage to correct value in Section 5.11 | 27 |
| • Added thermal characteristics for RHB and RSM packages in Section 5.18 | 30 |
| • Changed <i>Standby MCU Current Consumption, 32-kHz Clock, RAM and MCU Retention</i> by extending the temperature | 34 |
| • Changed BOD restriction footnote in Table 6-2 —restriction does not apply to die revision B and later..... | 42 |
| • Added Section 6.10 | 44 |
| • Changed Figure 8-1 | 47 |

| Changes from September 30, 2015 to October 28, 2015 | Page |
|---|-------------------|
| • Added the RSM and RHB packages | 8 |

| Changes from August 31, 2015 to September 30, 2015 | Page |
|---|-------------------|
| • Changed device status from: Product Preview to: Production Data | 1 |
| • Removed the RSM and RHB packages | 8 |

3 Device Comparison

Table 3-1 lists the device family overview.

Table 3-1. Device Family Overview

| DEVICE | RADIO SUPPORT | FLASH (KB) | RAM (KB) | GPIOs | PACKAGE SIZE |
|---------------|--|------------|----------|-------|---|
| CC1310F128RGZ | Proprietary, Wireless M-Bus, IEEE 802.15.4g | 128 | 20 | 30 | RGZ (7 mm × 7 mm VQFN48) |
| CC1310F64RGZ | | 64 | 16 | 30 | |
| CC1310F32RGZ | | 32 | 16 | 30 | |
| CC1310F128RHB | Proprietary, Wireless M-Bus, IEEE 802.15.4g | 128 | 20 | 15 | RHB (5 mm × 5 mm VQFN32) |
| CC1310F64RHB | | 64 | 16 | 15 | |
| CC1310F32RHB | | 32 | 16 | 15 | |
| CC1310F128RSM | Proprietary, Wireless M-Bus, IEEE 802.15.4g | 128 | 20 | 10 | RSM (4 mm × 4 mm VQFN32) |
| CC1310F64RSM | | 64 | 16 | 10 | |
| CC1310F32RSM | | 32 | 16 | 10 | |
| CC1350 | Sub-1 GHz Bluetooth low energy | 128 | 20 | 10-30 | RGZ (7 mm × 7 mm VQFN48) RHB (5 mm × 5 mm VQFN32) RSM (4 mm × 4 mm VQFN32) |
| CC2640R2 | Bluetooth 5 low energy 2.4-GHz proprietary FSK-based formats | 128 | 20 | 10-31 | RGZ (7 mm × 7 mm VQFN48) RHB (5 mm × 5 mm VQFN32) RSM (4 mm × 4 mm VQFN32) YFV (2.7 mm × 2.7 mm DSBGA34) |
| CC1312R | Sub-1 GHz Proprietary, Wireless M-Bus, IEEE 802.15.4g | 352 | 80 | 30 | RGZ (7 mm × 7 mm VQFN48) |
| CC1352R | Dual-band (2.4-GHz and Sub-1 GHz) Multiprotocol | 352 | 80 | 28 | RGZ (7 mm × 7 mm VQFN48) |
| CC2652R | Multiprotocol Bluetooth 5 low energy Zigbee Thread 2.4-GHz proprietary FSK-based formats | 352 | 80 | 31 | RGZ (7 mm × 7 mm VQFN48) |

3.1 Related Products

Wireless Connectivity The wireless connectivity portfolio offers a wide selection of low-power RF solutions suitable for a broad range of application. The offerings range from fully customized solutions to turnkey offerings with precertified hardware and software (protocol).

Sub-1 GHz Long-range, low power wireless connectivity solutions are offered in a wide range of Sub-1 GHz ISM bands.

Companion Products Review products that are frequently purchased or used with this product.

4 Terminal Configuration and Functions

4.1 Pin Diagram – RSM Package

Figure 4-1 shows the RSM pinout diagram.

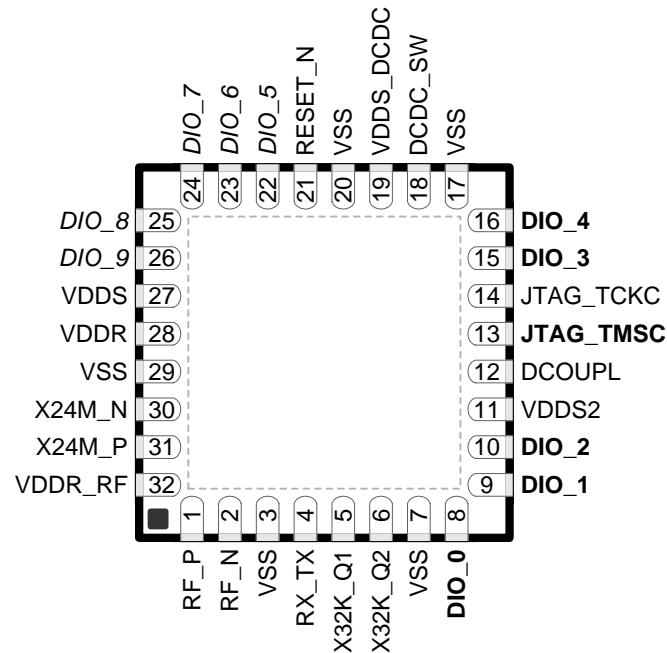

**Figure 4-1. RSM (4-mm x 4-mm) Pinout, 0.4-mm Pitch
Top View**

I/O pins marked in Figure 4-1 in **bold** have high-drive capabilities; they are as follows:

- Pin 8, DIO_0
- Pin 9, DIO_1
- Pin 10, DIO_2
- Pin 13, JTAG_TMSC
- Pin 15, DIO_3
- Pin 16, DIO_4

I/O pins marked in Figure 4-1 in *italics* have analog capabilities; they are as follows:

- Pin 22, DIO_5
- Pin 23, DIO_6
- Pin 24, DIO_7
- Pin 25, DIO_8
- Pin 26, DIO_9

4.2 Signal Descriptions – RSM Package

Table 4-1. Signal Descriptions – RSM Package

| PIN | | TYPE | DESCRIPTION |
|------------|---------------------|-----------------------|--|
| NAME | NO. | | |
| DCDC_SW | 18 | Power | Output from internal DC/DC ⁽¹⁾ |
| DCOUP | 12 | Power | 1.27-V regulated digital-supply decoupling capacitor ⁽²⁾ |
| DIO_0 | 8 | Digital I/O | GPIO, Sensor Controller, high-drive capability |
| DIO_1 | 9 | Digital I/O | GPIO, Sensor Controller, high-drive capability |
| DIO_2 | 10 | Digital I/O | GPIO, Sensor Controller, high-drive capability |
| DIO_3 | 15 | Digital I/O | GPIO, high-drive capability, JTAG_TDO |
| DIO_4 | 16 | Digital I/O | GPIO, high-drive capability, JTAG_TDI |
| DIO_5 | 22 | Digital or analog I/O | GPIO, Sensor Controller, analog |
| DIO_6 | 23 | Digital or analog I/O | GPIO, Sensor Controller, analog |
| DIO_7 | 24 | Digital or analog I/O | GPIO, Sensor Controller, analog |
| DIO_8 | 25 | Digital or analog I/O | GPIO, Sensor Controller, analog |
| DIO_9 | 26 | Digital or analog I/O | GPIO, Sensor Controller, analog |
| EGP | – | Power | Ground; exposed ground pad |
| JTAG_TMISC | 13 | Digital I/O | JTAG TMISC |
| JTAG_TCKC | 14 | Digital I/O | JTAG TCKC ⁽³⁾ |
| RESET_N | 21 | Digital input | Reset, active low. No internal pullup. |
| RF_N | 2 | RF I/O | Negative RF input signal to LNA during RX Negative RF output signal from PA during TX |
| RF_P | 1 | RF I/O | Positive RF input signal to LNA during RX Positive RF output signal from PA during TX |
| RX_TX | 4 | RF I/O | Optional bias pin for the RF LNA |
| VDDS | 27 | Power | 1.8-V to 3.8-V main chip supply ⁽¹⁾ |
| VDDS2 | 11 | Power | 1.8-V to 3.8-V GPIO supply ⁽¹⁾ |
| VDDS_DCDC | 19 | Power | 1.8-V to 3.8-V DC/DC supply |
| VDDR | 28 | Power | 1.7-V to 1.95-V supply, connect to output of internal DC/DC ⁽²⁾⁽⁴⁾ |
| VDDR_RF | 32 | Power | 1.7-V to 1.95-V supply, connect to output of internal DC/DC ⁽²⁾⁽⁵⁾ |
| VSS | 3, 7, 17, 20, 29 | Power | Ground |
| X32K_Q1 | 5 | Analog I/O | 32-kHz crystal oscillator pin 1 |
| X32K_Q2 | 6 | Analog I/O | 32-kHz crystal oscillator pin 2 |
| X24M_N | 30 | Analog I/O | 24-MHz crystal oscillator pin 1 |
| X24M_P | 31 | Analog I/O | 24-MHz crystal oscillator pin 2 |

(1) See the technical reference manual listed in [Section 8.3](#) for more details.

(2) Do not supply external circuitry from this pin.

(3) For design consideration regarding noise immunity for this pin, see the *JTAG Interface* chapter in the [CC13x0, CC26x0 SimpleLink™ Wireless MCU Technical Reference Manual](#).

(4) If internal DC/DC is not used, this pin is supplied internally from the main LDO.

(5) If internal DC/DC is not used, this pin must be connected to VDDR for supply from the main LDO.

4.3 Pin Diagram – RHB Package

Figure 4-2 shows the RHB pinout diagram.

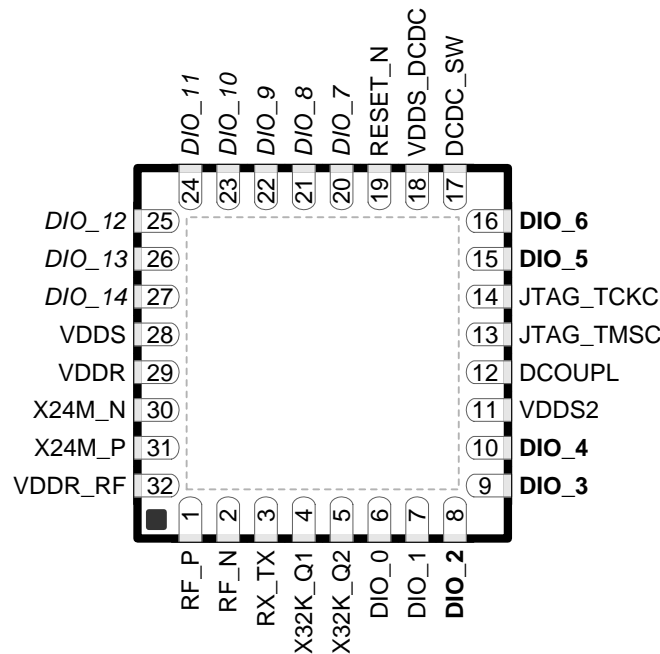

**Figure 4-2. RHB (5-mm × 5-mm) Pinout, 0.5-mm Pitch
Top View**

I/O pins marked in Figure 4-2 in **bold** have high-drive capabilities; they are as follows:

- Pin 8, DIO_2
- Pin 9, DIO_3
- Pin 10, DIO_4
- Pin 15, DIO_5
- Pin 16, DIO_6

I/O pins marked in Figure 4-2 in *italic* have analog capabilities; they are as follows:

- Pin 20, DIO_7
- Pin 21, DIO_8
- Pin 22, DIO_9
- Pin 23, DIO_10
- Pin 24, DIO_11
- Pin 25, DIO_12
- Pin 26, DIO_13
- Pin 27, DIO_14

4.4 Signal Descriptions – RHB Package

Table 4-2. Signal Descriptions – RHB Package

| PIN | | TYPE | DESCRIPTION |
|-------------|-----|-----------------------|--|
| NAME | NO. | | |
| DCDC_SW | 17 | Power | Output from internal DC/DC ⁽¹⁾ |
| DCOUP_L | 12 | Power | 1.27-V regulated digital-supply decoupling ⁽²⁾ |
| DIO_0 | 6 | Digital I/O | GPIO, Sensor Controller |
| DIO_1 | 7 | Digital I/O | GPIO, Sensor Controller |
| DIO_2 | 8 | Digital I/O | GPIO, Sensor Controller, high-drive capability |
| DIO_3 | 9 | Digital I/O | GPIO, Sensor Controller, high-drive capability |
| DIO_4 | 10 | Digital I/O | GPIO, Sensor Controller, high-drive capability |
| DIO_5 | 15 | Digital I/O | GPIO, high-drive capability, JTAG_TDO |
| DIO_6 | 16 | Digital I/O | GPIO, high-drive capability, JTAG_TDI |
| DIO_7 | 20 | Digital or analog I/O | GPIO, Sensor Controller, analog |
| DIO_8 | 21 | Digital or analog I/O | GPIO, Sensor Controller, analog |
| DIO_9 | 22 | Digital or analog I/O | GPIO, Sensor Controller, analog |
| DIO_10 | 23 | Digital or analog I/O | GPIO, Sensor Controller, Analog |
| DIO_11 | 24 | Digital or analog I/O | GPIO, Sensor Controller, analog |
| DIO_12 | 25 | Digital or analog I/O | GPIO, Sensor Controller, analog |
| DIO_13 | 26 | Digital or analog I/O | GPIO, Sensor Controller, analog |
| DIO_14 | 27 | Digital or analog I/O | GPIO, Sensor Controller, analog |
| EGP | – | Power | Ground; exposed ground pad |
| JTAG_TM_S_C | 13 | Digital I/O | JTAG TMS_C, high-drive capability |
| JTAG_TCK_C | 14 | Digital I/O | JTAG TCK_C ⁽³⁾ |
| RESET_N | 19 | Digital input | Reset, active low. No internal pullup. |
| RF_N | 2 | RF I/O | Negative RF input signal to LNA during RX Negative RF output signal from PA during TX |
| RF_P | 1 | RF I/O | Positive RF input signal to LNA during RX Positive RF output signal from PA during TX |
| RX_TX | 3 | RF I/O | Optional bias pin for the RF LNA |
| VDDR | 29 | Power | 1.7-V to 1.95-V supply, connect to output of internal DC/DC ⁽²⁾⁽⁴⁾ |
| VDDR_RF | 32 | Power | 1.7-V to 1.95-V supply, connect to output of internal DC/DC ⁽²⁾⁽⁵⁾ |
| VDDS | 28 | Power | 1.8-V to 3.8-V main chip supply ⁽¹⁾ |
| VDDS2 | 11 | Power | 1.8-V to 3.8-V GPIO supply ⁽¹⁾ |
| VDDS_DCDC | 18 | Power | 1.8-V to 3.8-V DC/DC supply |
| X24M_N | 30 | Analog I/O | 24-MHz crystal oscillator pin 1 |
| X24M_P | 31 | Analog I/O | 24-MHz crystal oscillator pin 2 |
| X32K_Q1 | 4 | Analog I/O | 32-kHz crystal oscillator pin 1 |
| X32K_Q2 | 5 | Analog I/O | 32-kHz crystal oscillator pin 2 |

(1) For more details, see the technical reference manual listed in [Section 8.3](#).

(2) Do not supply external circuitry from this pin.

(3) For design consideration regarding noise immunity for this pin, see the *JTAG Interface* chapter in the [CC13x0, CC26x0 SimpleLink™ Wireless MCU Technical Reference Manual](#).

(4) If internal DC/DC is not used, this pin is supplied internally from the main LDO.

(5) If internal DC/DC is not used, this pin must be connected to VDDR for supply from the main LDO.

4.5 Pin Diagram – RGZ Package

Figure 4-3 shows the RGZ pinout diagram.

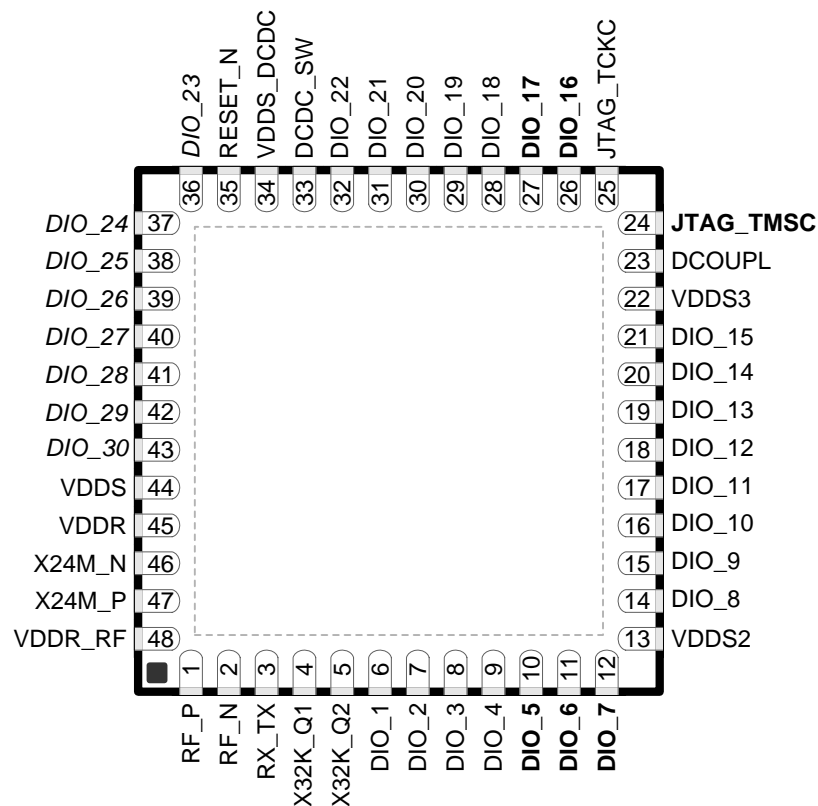

**Figure 4-3. RGZ (7-mm x 7-mm) Pinout, 0.5-mm Pitch
Top View**

I/O pins marked in Figure 4-3 in **bold** have high-drive capabilities; they are as follows:

- Pin 10, DIO_5
- Pin 11, DIO_6
- Pin 12, DIO_7
- Pin 24, JTAG_TMSC
- Pin 26, DIO_16
- Pin 27, DIO_17

I/O pins marked in Figure 4-3 in *italics* have analog capabilities; they are as follows:

- Pin 36, DIO_23
- Pin 37, DIO_24
- Pin 38, DIO_25
- Pin 39, DIO_26
- Pin 40, DIO_27
- Pin 41, DIO_28
- Pin 42, DIO_29
- Pin 43, DIO_30

4.6 Signal Descriptions – RGZ Package

Table 4-3. Signal Descriptions – RGZ Package

| PIN | | TYPE | DESCRIPTION |
|-------------|-----|-----------------------|--|
| NAME | NO. | | |
| DCDC_SW | 33 | Power | Output from internal DC/DC ⁽¹⁾⁽²⁾ |
| DCOUP_L | 23 | Power | 1.27-V regulated digital-supply (decoupling capacitor) ⁽²⁾ |
| DIO_1 | 6 | Digital I/O | GPIO, Sensor Controller |
| DIO_2 | 7 | Digital I/O | GPIO, Sensor Controller |
| DIO_3 | 8 | Digital I/O | GPIO, Sensor Controller |
| DIO_4 | 9 | Digital I/O | GPIO, Sensor Controller |
| DIO_5 | 10 | Digital I/O | GPIO, Sensor Controller, high-drive capability |
| DIO_6 | 11 | Digital I/O | GPIO, Sensor Controller, high-drive capability |
| DIO_7 | 12 | Digital I/O | GPIO, Sensor Controller, high-drive capability |
| DIO_8 | 14 | Digital I/O | GPIO |
| DIO_9 | 15 | Digital I/O | GPIO |
| DIO_10 | 16 | Digital I/O | GPIO |
| DIO_11 | 17 | Digital I/O | GPIO |
| DIO_12 | 18 | Digital I/O | GPIO |
| DIO_13 | 19 | Digital I/O | GPIO |
| DIO_14 | 20 | Digital I/O | GPIO |
| DIO_15 | 21 | Digital I/O | GPIO |
| DIO_16 | 26 | Digital I/O | GPIO, JTAG_TDO, high-drive capability |
| DIO_17 | 27 | Digital I/O | GPIO, JTAG_TDI, high-drive capability |
| DIO_18 | 28 | Digital I/O | GPIO |
| DIO_19 | 29 | Digital I/O | GPIO |
| DIO_20 | 30 | Digital I/O | GPIO |
| DIO_21 | 31 | Digital I/O | GPIO |
| DIO_22 | 32 | Digital I/O | GPIO |
| DIO_23 | 36 | Digital or analog I/O | GPIO, Sensor Controller, analog |
| DIO_24 | 37 | Digital or analog I/O | GPIO, Sensor Controller, analog |
| DIO_25 | 38 | Digital or analog I/O | GPIO, Sensor Controller, analog |
| DIO_26 | 39 | Digital or analog I/O | GPIO, Sensor Controller, analog |
| DIO_27 | 40 | Digital or analog I/O | GPIO, Sensor Controller, analog |
| DIO_28 | 41 | Digital or analog I/O | GPIO, Sensor Controller, analog |
| DIO_29 | 42 | Digital or analog I/O | GPIO, Sensor Controller, analog |
| DIO_30 | 43 | Digital or analog I/O | GPIO, Sensor Controller, analog |
| EGP | – | Power | Ground; exposed ground pad |
| JTAG_TM_S_C | 24 | Digital I/O | JTAG TM_S_C, high-drive capability |
| JTAG_TCK_C | 25 | Digital I/O | JTAG TCK_C ⁽³⁾ |
| RESET_N | 35 | Digital input | Reset, active-low. No internal pullup. |
| RF_N | 2 | RF I/O | Negative RF input signal to LNA during RX Negative RF output signal from PA during TX |
| RF_P | 1 | RF I/O | Positive RF input signal to LNA during RX Positive RF output signal from PA during TX |

(1) See technical reference manual listed in [Section 8.3](#) for more details.

(2) Do not supply external circuitry from this pin.

(3) For design consideration regarding noise immunity for this pin, see the *JTAG Interface* chapter in the [CC13x0, CC26x0 SimpleLink™ Wireless MCU Technical Reference Manual](#).

Table 4-3. Signal Descriptions – RGZ Package (continued)

| PIN | | TYPE | DESCRIPTION |
|-----------|-----|------------|---|
| NAME | NO. | | |
| VDDR | 45 | Power | 1.7-V to 1.95-V supply, connect to output of internal DC/DC ⁽²⁾⁽⁴⁾ |
| VDDR_RF | 48 | Power | 1.7-V to 1.95-V supply, connect to output of internal DC/DC ⁽²⁾⁽⁵⁾ |
| VDDS | 44 | Power | 1.8-V to 3.8-V main chip supply ⁽¹⁾ |
| VDDS2 | 13 | Power | 1.8-V to 3.8-V DIO supply ⁽¹⁾ |
| VDDS3 | 22 | Power | 1.8-V to 3.8-V DIO supply ⁽¹⁾ |
| VDDS_DCDC | 34 | Power | 1.8-V to 3.8-V DC/DC supply |
| X24M_N | 46 | Analog I/O | 24-MHz crystal oscillator pin 1 |
| X24M_P | 47 | Analog I/O | 24-MHz crystal oscillator pin 2 |
| RX_TX | 3 | RF I/O | Optional bias pin for the RF LNA |
| X32K_Q1 | 4 | Analog I/O | 32-kHz crystal oscillator pin 1 |
| X32K_Q2 | 5 | Analog I/O | 32-kHz crystal oscillator pin 2 |

(4) If internal DC/DC is not used, this pin is supplied internally from the main LDO.

(5) If internal DC/DC is not used, this pin must be connected to VDDR for supply from the main LDO.

5 Specifications

5.1 Absolute Maximum Ratings

over operating free-air temperature range (unless otherwise noted)⁽¹⁾⁽²⁾

| | | MIN | MAX | UNIT |
|--|---|------|----------------------------------|------|
| Supply voltage (V _{DDS} , V _{DDS2} , and V _{DDS3}) | | -0.3 | 4.1 | V |
| Voltage on any digital pin ⁽³⁾⁽⁴⁾ | | -0.3 | V _{DDSn} + 0.3, max 4.1 | V |
| Voltage on crystal oscillator pins X32K_Q1, X32K_Q2, X24M_N, and X24M_P | | -0.3 | V _{DDR} + 0.3, max 2.25 | V |
| Voltage on ADC input (V _{in}) | Voltage scaling enabled | -0.3 | V _{DDS} | V |
| | Voltage scaling disabled, internal reference | -0.3 | 1.49 | |
| | Voltage scaling disabled, V _{DDS} as reference | -0.3 | V _{DDS} / 2.9 | |
| Input RF level | | | 10 | dBm |
| Storage temperature (T _{stg}) | | -40 | 150 | °C |

- (1) Stresses beyond those listed under *Absolute Maximum Ratings* may cause permanent damage to the device. These are stress ratings only, and functional operation of the device at these or any other conditions beyond those indicated under *Recommended Operating Conditions* is not implied. Exposure to absolute-maximum-rated conditions for extended periods may affect device reliability.
- (2) All voltage values are with respect to ground, unless otherwise noted.
- (3) Including analog-capable DIO.
- (4) Each pin is referenced to a specific V_{DDSn} (V_{DDS}, V_{DDS2} or V_{DDS3}). For a pin-to-V_{DDSn} mapping table, see [Table 6-3](#).

5.2 ESD Ratings

| | | | VALUE | UNIT |
|------------------|-------------------------|--|----------|-------|
| V _{ESD} | Electrostatic discharge | Human body model (HBM), per ANSI/ESDA/JEDEC JS001 ⁽¹⁾ | All pins | ±3000 |
| | | Charged device model (CDM), per JESD22-C101 ⁽²⁾ | All pins | ±500 |

- (1) JEDEC document JEP155 states that 500-V HBM allows safe manufacturing with a standard ESD control process.
- (2) JEDEC document JEP157 states that 250-V CDM allows safe manufacturing with a standard ESD control process.

5.3 Recommended Operating Conditions

over operating free-air temperature range (unless otherwise noted)

| | | MIN | MAX | UNIT |
|---|---|--------------------------|-----|-------|
| Ambient temperature | | -40 | 85 | °C |
| Operating supply voltage (V _{DDS}) | | 1.8 | 3.8 | V |
| Operating supply voltages (V _{DDS2} and V _{DDS3}) | For operation in battery-powered and 3.3-V systems (internal DC/DC can be used to minimize power consumption) | V _{DDS} < 2.7 V | 1.8 | 3.8 |
| | | V _{DDS} ≥ 2.7 V | 1.9 | 3.8 |
| Rising supply voltage slew rate | | 0 | 100 | mV/μs |
| Falling supply voltage slew rate | | 0 | 20 | mV/μs |
| Falling supply voltage slew rate, with low-power flash setting ⁽¹⁾ | | | 3 | mV/μs |
| Positive temperature gradient in standby ⁽²⁾ | No limitation for negative temperature gradient, or outside standby mode | | 5 | °C/s |

- (1) For small coin-cell batteries, with high worst-case end-of-life equivalent source resistance, a 22-μF V_{DDS} input capacitor must be used to ensure compliance with this slew rate.
- (2) Applications using RCOSC_LF as sleep timer must also consider the drift in frequency caused by a change in temperature (see).

5.4 Power Consumption Summary

Measured on the Texas Instruments CC1310EM-7XD-7793 reference design unless otherwise noted. $T_c = 25^\circ\text{C}$, $V_{\text{DD5}} = 3.6\text{ V}$ with DC/DC enabled, unless otherwise noted. Using boost mode (increasing VDDR to 1.95 V), will increase currents in this table by 15% (does not apply to TX 14-dBm setting where this current is already included).

| PARAMETER | | TEST CONDITIONS | TYP | UNIT |
|---|--------------------------|--|--|---------------|
| I_{core} | Core current consumption | Reset. RESET_N pin asserted or VDD5 below power-on-reset threshold | 100 | nA |
| | | Shutdown. No clocks running, no retention | 185 | |
| | | Standby. With RTC, CPU, RAM, and (partial) register retention. RCOSC_LF | 0.7 | μA |
| | | Standby. With RTC, CPU, RAM, and (partial) register retention. XOSC_LF | 0.8 | |
| | | Idle. Supply Systems and RAM powered. | 570 | |
| | | Active. MCU running CoreMark at 48 MHz | 1.2 mA + 25.5 $\mu\text{A}/\text{MHz}$ | |
| | | Active. MCU running CoreMark at 48 MHz | 2.5 | mA |
| | | Active. MCU running CoreMark at 24 MHz | 1.9 | |
| | | Radio RX, 868 MHz | 5.5 | mA |
| | | Radio TX, 10-dBm output power, (G)FSK, 868 MHz | 13.4 | |
| | | Radio TX, OOK modulation, 10-dBm output power, AVG | 11.2 | mA |
| | | Radio TX, boost mode (VDDR = 1.95 V), 14-dBm output power, (G)FSK, 868 MHz | 23.5 | |
| | | Radio TX, OOK modulation, boost mode (VDDR = 1.95 V), 14-dBm, AVG | 14.8 | mA |
| | | Radio TX, boost mode (VDDR = 1.95 V), 15-dBm output power, (G)FSK, measured on CC1310EM-7XD-4251, 433.92 MHz | 25.1 | |
| | | Radio TX, 10-dBm output power, measured on CC1310EM-7XD-4251, 433.92 MHz | 13.2 | mA |
| | | | | |
| PERIPHERAL CURRENT CONSUMPTION⁽¹⁾⁽²⁾⁽³⁾ | | | | |
| I_{peri} | Peripheral power domain | Delta current with domain enabled | 20 | μA |
| | Serial power domain | Delta current with domain enabled | 13 | |
| | RF core | Delta current with power domain enabled, clock enabled, RF core idle | 237 | |
| | μDMA | Delta current with clock enabled, module idle | 130 | |
| | Timers | Delta current with clock enabled, module idle | 113 | |
| | $I^2\text{C}$ | Delta current with clock enabled, module idle | 12 | |
| | I2S | Delta current with clock enabled, module idle | 36 | |
| | SSI | Delta current with clock enabled, module idle | 93 | |
| | UART | Delta current with clock enabled, module idle | 164 | |

(1) Adds to core current I_{core} for each peripheral unit activated

(2) I_{peri} is not supported in standby or shutdown modes.

(3) Measured at 3.0 V

5.5 RF Characteristics

over operating free-air temperature range (unless otherwise noted)

| PARAMETER | MIN | TYP | MAX | UNIT |
|-----------------|--------------------|-----|--------------------|------|
| Frequency bands | 287 ⁽¹⁾ | | 351 ⁽¹⁾ | MHz |
| | 359 ⁽¹⁾ | | 439 ⁽¹⁾ | |
| | 431 | | 527 | |
| | 718 ⁽¹⁾ | | 878 ⁽¹⁾ | |
| | 861 | | 1054 | |

(1) These frequency bands are functionally verified. Radio settings for specific physical layer parameters can be made available upon request.

5.6 Receive (RX) Parameters, 861 MHz to 1054 MHz

Measured on the Texas Instruments CC1310EM-7XD-7793 reference design with $T_c = 25^\circ\text{C}$, $V_{\text{DD5}} = 3.0\text{ V}$, DC/DC enabled, $f_{\text{RF}} = 868\text{ MHz}$, unless otherwise noted. All measurements are performed at the antenna input with a combined RX and TX path.

| PARAMETER | TEST CONDITIONS | MIN | TYP | MAX | UNIT |
|---|---|--------------|---------|------|------|
| Data rate | | Up to 4 Mbps | | | bps |
| Data rate offset tolerance, IEEE 802.15.4g PHY | 50 kbps, GFSK, 25-kHz deviation, 100-kHz RX bandwidth (same modulation format as IEEE 802.15.4g mandatory mode), BER = 10^{-3} | | 1600 | | ppm |
| Data rate step size | | | 1.5 | | bps |
| Digital channel filter programmable bandwidth | Using VCO divide by 5 setting | 40 | | 4000 | kHz |
| Receiver sensitivity, 50 kbps | 50 kbps, GFSK, 25-kHz deviation, 100-kHz RX bandwidth (same modulation format as IEEE 802.15.4g mandatory mode), BER = 10^{-2} . 868 MHz and 915 MHz | | -110 | | dBm |
| Receiver saturation | 50 kbps, GFSK, 25-kHz deviation, 100-kHz RX bandwidth (same modulation format as IEEE 802.15.4g mandatory mode), BER = 10^{-2} | | 10 | | dBm |
| Selectivity, $\pm 200\text{ kHz}$, 50 kbps | Wanted signal 3 dB above sensitivity limit. 50 kbps, GFSK, 25-kHz deviation, 100-kHz RX bandwidth (same modulation format as IEEE 802.15.4g mandatory mode), BER = 10^{-2} | | 44, 47 | | dB |
| Selectivity, $\pm 400\text{ kHz}$, 50 kbps | Wanted signal 3 dB above sensitivity limit. 50 kbps, GFSK, 25-kHz deviation, 100-kHz RX bandwidth (same modulation format as IEEE 802.15.4g mandatory mode), BER = 10^{-2} | | 48, 53 | | dB |
| Blocking $\pm 1\text{ MHz}$, 50 kbps | Wanted signal 3 dB above sensitivity limit. 50 kbps, GFSK, 25-kHz deviation, 100-kHz RX bandwidth (same modulation format as IEEE 802.15.4g mandatory mode), BER = 10^{-2} | | 59, 62 | | dB |
| Blocking $\pm 2\text{ MHz}$, 50 kbps | Wanted signal 3 dB above sensitivity limit. 50 kbps, GFSK, 25-kHz deviation, 100-kHz RX bandwidth (same modulation format as IEEE 802.15.4g mandatory mode), BER = 10^{-2} | | 64, 65 | | dB |
| Blocking $\pm 5\text{ MHz}$, 50 kbps | Wanted signal 3 dB above sensitivity limit. 50 kbps, GFSK, 25-kHz deviation, 100-kHz RX bandwidth (same modulation format as IEEE 802.15.4g mandatory mode), BER = 10^{-2} | | 67, 68 | | dB |
| Blocking $\pm 10\text{ MHz}$, 50 kbps | Wanted signal 3 dB above sensitivity limit. 50 kbps, GFSK, 25-kHz deviation, 100-kHz RX bandwidth (same modulation format as IEEE 802.15.4g mandatory mode), BER = 10^{-2} | | 76, 76 | | dB |
| Spurious emissions 1 GHz to 13 GHz (VCO leakage at 3.5 GHz) and 30 MHz to 1 GHz | Conducted emissions measured according to ETSI EN 300 220 | | -70 | | dBm |
| Image rejection (image compensation enabled, the image compensation is calibrated in production), 50 kbps | Wanted signal 3 dB above sensitivity limit. 50 kbps, GFSK, 25-kHz deviation, 100-kHz RX bandwidth (same modulation format as IEEE 802.15.4g mandatory mode), BER = 10^{-2} | | 44 | | dB |
| RSSI dynamic range | 50 kbps, GFSK, 25-kHz deviation, 100-kHz RX bandwidth (same modulation format as IEEE 802.15.4g mandatory mode). Starting from the sensitivity limit. This range will give an accuracy of $\pm 2\text{ dB}$. | | 95 | | dB |
| RSSI accuracy | 50 kbps, GFSK, 25-kHz deviation, 100-kHz RX bandwidth (same modulation format as IEEE 802.15.4g mandatory mode). Starting from the sensitivity limit across the given dynamic range. | | ± 2 | | dB |
| Receiver sensitivity, 500 kbps | GFSK, 175-kHz deviation, 1.243-MHz RX bandwidth, BER = 10^{-2} | | -97 | | dBm |
| Blocking, $\pm 2\text{ MHz}$, 500 kbps | Wanted signal 3 dB above sensitivity limit. 500 kbps, GFSK, 175-kHz deviation, 1.243-MHz RX bandwidth, BER = 10^{-2} | | 35, 36 | | dB |

Receive (RX) Parameters, 861 MHz to 1054 MHz (continued)

Measured on the Texas Instruments CC1310EM-7XD-7793 reference design with $T_c = 25^\circ\text{C}$, $V_{\text{DSS}} = 3.0\text{ V}$, DC/DC enabled, $f_{\text{RF}} = 868\text{ MHz}$, unless otherwise noted. All measurements are performed at the antenna input with a combined RX and TX path.

| PARAMETER | TEST CONDITIONS | MIN | TYP | MAX | UNIT |
|---|--|-----|--------|-----|------|
| Blocking, $\pm 10\text{ MHz}$, 500 kbps | Wanted signal 3 dB above sensitivity limit. 500 kbps, GFSK, 175-kHz deviation, 1.243-MHz RX bandwidth, $\text{BER} = 10^{-2}$ | | 55, 47 | | dB |
| Receiver sensitivity, long-range mode, 5 kbps | 20 ksym/s, GFSK, 5-kHz deviation, FEC (half rate), DSSS = 2, 49-kHz RX bandwidth, $\text{BER} = 10^{-2}$. 868 MHz and 915 MHz | | -119 | | dBm |
| Receiver sensitivity, long-range mode, 2.5 kbps | 20 ksym/s, GFSK, 5-kHz deviation, FEC (half rate), DSSS = 4, 49-kHz RX bandwidth, $\text{BER} = 10^{-2}$. 868 MHz and 915 MHz | | -120 | | dBm |
| Receiver sensitivity, long-range mode, 1.25 kbps | 20 ksym/s, GFSK, 5-kHz deviation, FEC (half rate), DSSS = 8, 49-kHz RX bandwidth, $\text{BER} = 10^{-2}$. 868 MHz and 915 MHz | | -121 | | dBm |
| Selectivity, $\pm 100\text{ kHz}$, long-range mode, 5 kbps | Wanted signal 3 dB above sensitivity limit. 20 ksym/s, GFSK, 5-kHz deviation, FEC (half rate), DSSS = 2, 49-kHz RX bandwidth, $\text{BER} = 10^{-2}$ | | 47, 47 | | dB |
| Selectivity, $\pm 200\text{ kHz}$, long-range mode, 5 kbps | Wanted signal 3 dB above sensitivity limit. 20 ksym/s, GFSK, 5-kHz deviation, FEC (half rate), DSSS = 2, 49-kHz RX bandwidth, $\text{BER} = 10^{-2}$ | | 54, 55 | | dB |
| Selectivity, $\pm 300\text{ kHz}$, long-range mode, 5 kbps | Wanted signal 3 dB above sensitivity limit. 20 ksym/s, GFSK, 5-kHz deviation, FEC (half rate), DSSS = 2, 49-kHz RX bandwidth, $\text{BER} = 10^{-2}$ | | 57, 56 | | dB |
| Blocking, $\pm 1\text{ MHz}$, long-range mode, 5 kbps | Wanted signal 3 dB above sensitivity limit. 20 ksym/s, GFSK, 5-kHz deviation, FEC (half rate), DSSS = 2, 49-kHz RX bandwidth, $\text{BER} = 10^{-2}$ | | 68, 67 | | dB |
| Blocking, $\pm 2\text{ MHz}$, long-range mode, 5 kbps | Wanted signal 3 dB above sensitivity limit. 20 ksym/s, GFSK, 5-kHz deviation, FEC (half rate), DSSS = 2, 49-kHz RX bandwidth, $\text{BER} = 10^{-2}$ | | 74, 74 | | dB |
| Blocking, $\pm 10\text{ MHz}$, long-range mode, 5 kbps | Wanted signal 3 dB above sensitivity limit. 20 ksym/s, GFSK, 5-kHz deviation, FEC (half rate), DSSS = 2, 49-kHz RX bandwidth, $\text{BER} = 10^{-2}$ | | 85, 85 | | dB |
| Image rejection (image compensation enabled, the image compensation is calibrated in production), long-range mode, 5 kbps | Wanted signal 3 dB above sensitivity limit. 20 ksym/s, GFSK, 5-kHz deviation, FEC (half rate), DSSS = 2, 49-kHz RX bandwidth, $\text{BER} = 10^{-2}$ | | 52 | | dB |
| Receiver sensitivity, wM-BUS S2-mode, 32.768 kbps | $f_{\text{RF}} = 868.3\text{ MHz}$, 32.768 ksym/s, Manchester coding, FSK, 50-kHz deviation, 196-kHz RX bandwidth, $\text{BER} = 10^{-2}$ | | -111 | | dBm |
| Selectivity, $\pm 200\text{ kHz}$, wM-BUS S2-mode, 32.768 kbps | Wanted signal 3 dB above sensitivity limit. $f_{\text{RF}} = 868.3\text{ MHz}$, 32.768 ksym/s, Manchester coding, FSK, 50-kHz deviation, 196-kHz RX bandwidth, $\text{BER} = 10^{-2}$ | | 42, 43 | | dB |
| Selectivity, $\pm 400\text{ kHz}$, wM-BUS S2-mode, 32.768 kbps | Wanted signal 3 dB above sensitivity limit. $f_{\text{RF}} = 868.3\text{ MHz}$, 32.768 ksym/s, Manchester coding, FSK, 50-kHz deviation, 196-kHz RX bandwidth, $\text{BER} = 10^{-2}$ | | 41, 47 | | dB |
| Blocking, $\pm 1\text{ MHz}$, wM-BUS S2-mode, 32.768 kbps | Wanted signal 3 dB above sensitivity limit. $f_{\text{RF}} = 868.3\text{ MHz}$, 32.768 ksym/s, Manchester coding, FSK, 50-kHz deviation, 196-kHz RX bandwidth, $\text{BER} = 10^{-2}$ | | 43, 52 | | dB |
| Blocking, $\pm 2\text{ MHz}$, wM-BUS S2-mode, 32.768 kbps | Wanted signal 3 dB above sensitivity limit. $f_{\text{RF}} = 868.3\text{ MHz}$, 32.768 ksym/s, Manchester coding, FSK, 50-kHz deviation, 196-kHz RX bandwidth, $\text{BER} = 10^{-2}$ | | 52, 55 | | dB |
| Blocking, $\pm 10\text{ MHz}$, wM-BUS S2-mode, 32.768 kbps | Wanted signal 3 dB above sensitivity limit. $f_{\text{RF}} = 868.3\text{ MHz}$, 32.768 ksym/s, Manchester coding, FSK, 50-kHz deviation, 196-kHz RX bandwidth, $\text{BER} = 10^{-2}$ | | 68, 72 | | dB |

Receive (RX) Parameters, 861 MHz to 1054 MHz (continued)

Measured on the Texas Instruments CC1310EM-7XD-7793 reference design with $T_c = 25^\circ\text{C}$, $V_{\text{DDS}} = 3.0\text{ V}$, DC/DC enabled, $f_{\text{RF}} = 868\text{ MHz}$, unless otherwise noted. All measurements are performed at the antenna input with a combined RX and TX path.

| PARAMETER | TEST CONDITIONS | MIN | TYP | MAX | UNIT |
|---|--|-----|--------|-----|------|
| Image rejection (image compensation enabled, the image compensation is calibrated in production), wM-BUS S2-mode, 32.768 kbps | Wanted signal 3 dB above sensitivity limit. $f_{\text{RF}} = 868.3\text{ MHz}$, 32.768 ksym/s, Manchester coding, FSK, 50-kHz deviation, 196-kHz RX bandwidth, $\text{BER} = 10^{-2}$ | | 43 | | dB |
| Receiver sensitivity, wM-BUS C-mode, 100 kbps | $f_{\text{RF}} = 868.95\text{ MHz}$, 100 ksym/s, NRZ coding, FSK, 45-kHz deviation, 196-kHz RX bandwidth, $\text{BER} = 10^{-2}$ | | -107 | | dBm |
| Selectivity, $\pm 400\text{ kHz}$, wM-BUS C-mode, 100 kbps | Wanted signal 3 dB above sensitivity limit. $f_{\text{RF}} = 868.95\text{ MHz}$, 100 ksym/s, NRZ coding, FSK, 45-kHz deviation, 196-kHz RX bandwidth, $\text{BER} = 10^{-2}$ | | 41, 46 | | dB |
| Selectivity, $\pm 800\text{ kHz}$, wM-BUS C-mode, 100 kbps | Wanted signal 3 dB above sensitivity limit. $f_{\text{RF}} = 868.95\text{ MHz}$, 100 ksym/s, NRZ coding, FSK, 45-kHz deviation, 196-kHz RX bandwidth, $\text{BER} = 10^{-2}$ | | 41, 50 | | dB |
| Blocking, $\pm 1\text{ MHz}$, wM-BUS C-mode, 100 kbps | Wanted signal 3 dB above sensitivity limit. $f_{\text{RF}} = 868.95\text{ MHz}$, 100 ksym/s, NRZ coding, FSK, 45-kHz deviation, 196-kHz RX bandwidth, $\text{BER} = 10^{-2}$ | | 43, 51 | | dB |
| Blocking, $\pm 2\text{ MHz}$, wM-BUS C-mode, 100 kbps | Wanted signal 3 dB above sensitivity limit. $f_{\text{RF}} = 868.95\text{ MHz}$, 100 ksym/s, NRZ coding, FSK, 45-kHz deviation, 196-kHz RX bandwidth, $\text{BER} = 10^{-2}$ | | 51, 53 | | dB |
| Blocking, $\pm 5\text{ MHz}$, wM-BUS C-mode, 100 kbps | Wanted signal 3 dB above sensitivity limit. $f_{\text{RF}} = 868.95\text{ MHz}$, 100 ksym/s, NRZ coding, FSK, 45-kHz deviation, 196-kHz RX bandwidth, $\text{BER} = 10^{-2}$ | | 55, 61 | | dB |
| Blocking, $\pm 10\text{ MHz}$, wM-BUS C-mode, 100 kbps | Wanted signal 3 dB above sensitivity limit. $f_{\text{RF}} = 868.95\text{ MHz}$, 100 ksym/s, NRZ coding, FSK, 45-kHz deviation, 196-kHz RX bandwidth, $\text{BER} = 10^{-2}$ | | 67, 68 | | dB |
| Receiver sensitivity, wM-BUS T-mode, 100 kbps | $f_{\text{RF}} = 868.95\text{ MHz}$, 100 ksym/s, 3 out of 6 coding, FSK, 45-kHz deviation, 196-kHz RX bandwidth, $\text{BER} = 10^{-2}$ | | -105 | | dBm |
| Selectivity, $\pm 400\text{ kHz}$, wM-BUS T-mode, 100 kbps | Wanted signal 3 dB above sensitivity limit. $f_{\text{RF}} = 868.95\text{ MHz}$, 100 ksym/s, 3 out of 6 coding, FSK, 45-kHz deviation, 196-kHz RX bandwidth, $\text{BER} = 10^{-2}$ | | 41, 46 | | dB |
| Selectivity, $\pm 800\text{ kHz}$, wM-BUS T-mode, 100 kbps | Wanted signal 3 dB above sensitivity limit. $f_{\text{RF}} = 868.95\text{ MHz}$, 100 ksym/s, 3 out of 6 coding, FSK, 45-kHz deviation, 196-kHz RX bandwidth, $\text{BER} = 10^{-2}$ | | 41, 50 | | dB |
| Blocking, $\pm 1\text{ MHz}$, wM-BUS T-mode, 100 kbps | Wanted signal 3 dB above sensitivity limit. $f_{\text{RF}} = 868.95\text{ MHz}$, 100 ksym/s, 3 out of 6 coding, FSK, 45-kHz deviation, 196-kHz RX bandwidth, $\text{BER} = 10^{-2}$ | | 42, 51 | | dB |
| Blocking, $\pm 2\text{ MHz}$, wM-BUS T-mode, 100 kbps | Wanted signal 3 dB above sensitivity limit. $f_{\text{RF}} = 868.95\text{ MHz}$, 100 ksym/s, 3 out of 6 coding, FSK, 45-kHz deviation, 196-kHz RX bandwidth, $\text{BER} = 10^{-2}$ | | 51, 52 | | dB |
| Blocking, $\pm 5\text{ MHz}$, wM-BUS T-mode, 100 kbps | Wanted signal 3 dB above sensitivity limit. $f_{\text{RF}} = 868.95\text{ MHz}$, 100 ksym/s, 3 out of 6 coding, FSK, 45-kHz deviation, 196-kHz RX bandwidth, $\text{BER} = 10^{-2}$ | | 54, 60 | | dB |
| Blocking, $\pm 10\text{ MHz}$, wM-BUS T-mode, 100 kbps | Wanted signal 3 dB above sensitivity limit. $f_{\text{RF}} = 868.95\text{ MHz}$, 100 ksym/s, 3 out of 6 coding, FSK, 45-kHz deviation, 196-kHz RX bandwidth, $\text{BER} = 10^{-2}$ | | 67, 68 | | dB |
| Receiver sensitivity, WideBand-DSSS (WB-DSSS), 30 kbps | $f_{\text{RF}} = 915\text{ MHz}$, 480 ksym/s, GFSK, 195-kHz deviation, FEC (half rate), DSSS = 8, 622-kHz RX bandwidth, $\text{BER} = 10^{-2}$ | | -109 | | dBm |
| Blocking, $\pm 1\text{ MHz}$, WB-DSSS, 30 kbps | Wanted signal 3 dB above sensitivity limit. $f_{\text{RF}} = 915\text{ MHz}$, 480 ksym/s, GFSK, 195-kHz deviation, FEC (half rate), DSSS = 8, 622-kHz RX bandwidth, $\text{BER} = 10^{-2}$ | | 57, 57 | | dB |
| Blocking, $\pm 2\text{ MHz}$, WB-DSSS, 30 kbps | Wanted signal 3 dB above sensitivity limit. $f_{\text{RF}} = 915\text{ MHz}$, 480 ksym/s, GFSK, 195-kHz deviation, FEC (half rate), DSSS = 8, 622-kHz RX bandwidth, $\text{BER} = 10^{-2}$ | | 58, 58 | | dB |

Receive (RX) Parameters, 861 MHz to 1054 MHz (continued)

Measured on the Texas Instruments CC1310EM-7XD-7793 reference design with $T_c = 25^\circ\text{C}$, $V_{\text{DDS}} = 3.0\text{ V}$, DC/DC enabled, $f_{\text{RF}} = 868\text{ MHz}$, unless otherwise noted. All measurements are performed at the antenna input with a combined RX and TX path.

| PARAMETER | TEST CONDITIONS | MIN | TYP | MAX | UNIT |
|---|---|-----|--------|-----|------|
| Blocking, $\pm 5\text{ MHz}$, WB-DSSS, 30 kbps | Wanted signal 3 dB above sensitivity limit. $f_{\text{RF}} = 915\text{ MHz}$, 480 ksym/s, GFSK, 195-kHz deviation, FEC (half rate), DSSS = 8, 622-kHz RX bandwidth, BER = 10^{-2} | | 59, 57 | | dB |
| Blocking, $\pm 10\text{ MHz}$, WB-DSSS, 30 kbps | Wanted signal 3 dB above sensitivity limit. $f_{\text{RF}} = 915\text{ MHz}$, 480 ksym/s, GFSK, 195-kHz deviation, FEC (half rate), DSSS = 8, 622-kHz RX bandwidth, BER = 10^{-2} | | 71, 68 | | dB |
| Receiver sensitivity, WideBand-DSSS (WB-DSSS), 60 kbps | $f_{\text{RF}} = 915\text{ MHz}$, 480 ksym/s, GFSK, 195-kHz deviation, FEC (half rate), DSSS = 4, 622-kHz RX bandwidth, BER = 10^{-2} | | -108 | | dBm |
| Blocking, $\pm 1\text{ MHz}$, WB-DSSS, 60 kbps | Wanted signal 3 dB above sensitivity limit. $f_{\text{RF}} = 915\text{ MHz}$, 480 ksym/s, GFSK, 195-kHz deviation, FEC (half rate), DSSS = 4, 622-kHz RX bandwidth, BER = 10^{-2} | | 56, 56 | | dB |
| Blocking, $\pm 2\text{ MHz}$, WB-DSSS, 60 kbps | Wanted signal 3 dB above sensitivity limit. $f_{\text{RF}} = 915\text{ MHz}$, 480 ksym/s, GFSK, 195-kHz deviation, FEC (half rate), DSSS = 4, 622-kHz RX bandwidth, BER = 10^{-2} | | 57, 57 | | dB |
| Blocking, $\pm 5\text{ MHz}$, WB-DSSS, 60 kbps | Wanted signal 3 dB above sensitivity limit. $f_{\text{RF}} = 915\text{ MHz}$, 480 ksym/s, GFSK, 195-kHz deviation, FEC (half rate), DSSS = 4, 622-kHz RX bandwidth, BER = 10^{-2} | | 57, 56 | | dB |
| Blocking, $\pm 10\text{ MHz}$, WB-DSSS, 60 kbps | Wanted signal 3 dB above sensitivity limit. $f_{\text{RF}} = 915\text{ MHz}$, 480 ksym/s, GFSK, 195-kHz deviation, FEC (half rate), DSSS = 4, 622-kHz RX bandwidth, BER = 10^{-2} | | 70, 67 | | dB |
| Receiver sensitivity, WideBand-DSSS (WB-DSSS), 120 kbps | $f_{\text{RF}} = 915\text{ MHz}$, 480 ksym/s, GFSK, 195-kHz deviation, FEC (half rate), DSSS = 2, 622-kHz RX bandwidth, BER = 10^{-2} | | -106 | | dBm |
| Blocking, $\pm 1\text{ MHz}$, WB-DSSS, 120 kbps | Wanted signal 3 dB above sensitivity limit. $f_{\text{RF}} = 915\text{ MHz}$, 480 ksym/s, GFSK, 195-kHz deviation, FEC (half rate), DSSS = 2, 622-kHz RX bandwidth, BER = 10^{-2} | | 54, 54 | | dB |
| Blocking, $\pm 2\text{ MHz}$, WB-DSSS, 120 kbps | Wanted signal 3 dB above sensitivity limit. $f_{\text{RF}} = 915\text{ MHz}$, 480 ksym/s, GFSK, 195-kHz deviation, FEC (half rate), DSSS = 2, 622-kHz RX bandwidth, BER = 10^{-2} | | 55, 55 | | dB |
| Blocking, $\pm 5\text{ MHz}$, WB-DSSS, 120 kbps | Wanted signal 3 dB above sensitivity limit. $f_{\text{RF}} = 915\text{ MHz}$, 480 ksym/s, GFSK, 195-kHz deviation, FEC (half rate), DSSS = 2, 622-kHz RX bandwidth, BER = 10^{-2} | | 55, 54 | | dB |
| Blocking, $\pm 10\text{ MHz}$, WB-DSSS, 120 kbps | Wanted signal 3 dB above sensitivity limit. $f_{\text{RF}} = 915\text{ MHz}$, 480 ksym/s, GFSK, 195-kHz deviation, FEC (half rate), DSSS = 2, 622-kHz RX bandwidth, BER = 10^{-2} | | 69, 65 | | dB |
| Receiver sensitivity, WideBand-DSSS (WB-DSSS), 240 kbps | $f_{\text{RF}} = 915\text{ MHz}$, 480 ksym/s, GFSK, 195-kHz deviation, FEC (half rate), DSSS = 1, 622-kHz RX bandwidth, BER = 10^{-2} | | -105 | | dBm |
| Blocking, $\pm 1\text{ MHz}$, WB-DSSS, 240 kbps | Wanted signal 3 dB above sensitivity limit. $f_{\text{RF}} = 915\text{ MHz}$, 480 ksym/s, GFSK, 195-kHz deviation, FEC (half rate), DSSS = 1, 622-kHz RX bandwidth, BER = 10^{-2} | | 53, 53 | | dB |
| Blocking, $\pm 2\text{ MHz}$, WB-DSSS, 240 kbps | Wanted signal 3 dB above sensitivity limit. $f_{\text{RF}} = 915\text{ MHz}$, 480 ksym/s, GFSK, 195-kHz deviation, FEC (half rate), DSSS = 1, 622-kHz RX bandwidth, BER = 10^{-2} | | 53, 54 | | dB |

Receive (RX) Parameters, 861 MHz to 1054 MHz (continued)

Measured on the Texas Instruments CC1310EM-7XD-7793 reference design with $T_c = 25^\circ\text{C}$, $V_{\text{DDS}} = 3.0\text{ V}$, DC/DC enabled, $f_{\text{RF}} = 868\text{ MHz}$, unless otherwise noted. All measurements are performed at the antenna input with a combined RX and TX path.

| PARAMETER | TEST CONDITIONS | MIN | TYP | MAX | UNIT |
|--|---|-----|--------|-----|------|
| Blocking, $\pm 5\text{ MHz}$, WB-DSSS, 240 kbps | Wanted signal 3 dB above sensitivity limit. $f_{\text{RF}} = 915\text{ MHz}$, 480 ksym/s, GFSK, 195-kHz deviation, FEC (half rate), DSSS = 1, 622-kHz RX bandwidth, BER = 10^{-2} | | 53, 54 | | dB |
| Blocking, $\pm 10\text{ MHz}$, WB-DSSS, 240 kbps | Wanted signal 3 dB above sensitivity limit. $f_{\text{RF}} = 915\text{ MHz}$, 480 ksym/s, GFSK, 195-kHz deviation, FEC (half rate), DSSS = 1, 622-kHz RX bandwidth, BER = 10^{-2} | | 68, 64 | | dB |
| Receiver sensitivity, 10 kbps | GFSK, 19-kHz deviation, 78-kHz RX bandwidth, BER = 10^{-2} | | -114 | | dBm |
| Selectivity, $\pm 100\text{ kHz}$, 10 kbps | Wanted signal 3 dB above sensitivity limit. 10 kbps, GFSK, 19-kHz deviation, 78-kHz RX bandwidth, BER = 10^{-2} | | 40, 40 | | dB |
| Selectivity, $\pm 200\text{ kHz}$, 10 kbps | Wanted signal 3 dB above sensitivity limit. 10 kbps, GFSK, 19-kHz deviation, 78-kHz RX bandwidth, BER = 10^{-2} | | 46, 44 | | dB |
| Selectivity, $\pm 400\text{ kHz}$, 10 kbps | Wanted signal 3 dB above sensitivity limit. 10 kbps, GFSK, 19-kHz deviation, 78-kHz RX bandwidth, BER = 10^{-2} | | 50, 45 | | dB |
| Blocking, $\pm 2\text{ MHz}$, 10 kbps | Wanted signal 3 dB above sensitivity limit. 10 kbps, GFSK, 19-kHz deviation, 78-kHz RX bandwidth, BER = 10^{-2} | | 62, 61 | | dB |
| Blocking, $\pm 10\text{ MHz}$, 10 kbps | Wanted signal 3 dB above sensitivity limit. 10 kbps, GFSK, 19-kHz deviation, 78-kHz RX bandwidth, BER = 10^{-2} | | 76, 72 | | dB |
| Image rejection (image compensation enabled, the image compensation is calibrated in production), 10 kbps | Wanted signal 3 dB above sensitivity limit. 10 kbps, GFSK, 19-kHz deviation, 78-kHz RX bandwidth, BER = 10^{-2} | | 43 | | dB |
| Receiver sensitivity, 4.8 kbps | GFSK, 5.2-kHz deviation, 49-kHz RX bandwidth, BER = 10^{-2} | | -114 | | dBm |
| Selectivity, $\pm 100\text{ kHz}$, 4.8 kbps | Wanted signal 3 dB above sensitivity limit. 4.8 kbps, GFSK, 5.2-kHz deviation, 49-kHz RX bandwidth, BER = 10^{-2} | | 44, 43 | | dB |
| Selectivity, $\pm 200\text{ kHz}$, 4.8 kbps | Wanted signal 3 dB above sensitivity limit. 4.8 kbps, GFSK, 5.2-kHz deviation, 49-kHz RX bandwidth, BER = 10^{-2} | | 49, 48 | | dB |
| Selectivity, $\pm 400\text{ kHz}$, 4.8 kbps | Wanted signal 3 dB above sensitivity limit. 4.8 kbps, GFSK, 5.2-kHz deviation, 49-kHz RX bandwidth, BER = 10^{-2} | | 52, 49 | | dB |
| Blocking, $\pm 2\text{ MHz}$, 4.8 kbps | Wanted signal 3 dB above sensitivity limit. 4.8 kbps, GFSK, 5.2-kHz deviation, 49-kHz RX bandwidth, BER = 10^{-2} | | 64, 63 | | dB |
| Blocking, $\pm 10\text{ MHz}$, 4.8 kbps | Wanted signal 3 dB above sensitivity limit. 4.8 kbps, GFSK, 5.2-kHz deviation, 49-kHz RX bandwidth, BER = 10^{-2} | | 73, 72 | | dB |
| Image rejection (image compensation enabled, the image compensation is calibrated in production), 4.8 kbps | Wanted signal 3 dB above sensitivity limit. 4.8 kbps, GFSK, 5.2-kHz deviation, 49-kHz RX bandwidth, BER = 10^{-2} | | 43 | | dB |
| Receiver sensitivity, CC1101 compatible mode, 2.4 kbps | GFSK, 5.2-kHz deviation (commonly used settings on CC1101), 49-kHz RX bandwidth, BER = 10^{-2} | | -116 | | dBm |
| Selectivity, $\pm 100\text{ kHz}$, CC1101 compatible mode, 2.4 kbps | Wanted signal 3 dB above sensitivity limit. 2.4 kbps, GFSK, 5.2-kHz deviation (commonly used settings on CC1101), 49-kHz RX bandwidth, BER = 10^{-2} | | 45, 44 | | dB |
| Selectivity, $\pm 200\text{ kHz}$, CC1101 compatible mode, 2.4 kbps | Wanted signal 3 dB above sensitivity limit. 2.4 kbps, GFSK, 5.2-kHz deviation (commonly used settings on CC1101), 49-kHz RX bandwidth, BER = 10^{-2} | | 51, 47 | | dB |

Receive (RX) Parameters, 861 MHz to 1054 MHz (continued)

Measured on the Texas Instruments CC1310EM-7XD-7793 reference design with $T_c = 25^\circ\text{C}$, $V_{\text{DDS}} = 3.0\text{ V}$, DC/DC enabled, $f_{\text{RF}} = 868\text{ MHz}$, unless otherwise noted. All measurements are performed at the antenna input with a combined RX and TX path.

| PARAMETER | TEST CONDITIONS | MIN | TYP | MAX | UNIT |
|--|---|-----|--------|-----|------|
| Blocking, $\pm 2\text{ MHz}$, CC1101 compatible mode, 2.4 kbps | Wanted signal 3 dB above sensitivity limit. 2.4 kbps, GFSK, 5.2-kHz deviation (commonly used settings on CC1101), 49-kHz RX bandwidth, $\text{BER} = 10^{-2}$ | | 63, 62 | | dB |
| Blocking, $\pm 10\text{ MHz}$, CC1101 compatible mode, 2.4 kbps | Wanted signal 3 dB above sensitivity limit. 2.4 kbps, GFSK, 5.2-kHz deviation (commonly used settings on CC1101), 49-kHz RX bandwidth, $\text{BER} = 10^{-2}$ | | 76, 71 | | dB |
| Image rejection (image compensation enabled, the image compensation is calibrated in production), CC1101 compatible mode, 2.4 kbps | Wanted signal 3 dB above sensitivity limit. 2.4 kbps, GFSK, 5.2-kHz deviation (commonly used settings on CC1101), 49-kHz RX bandwidth, $\text{BER} = 10^{-2}$ | | 45 | | dB |
| Receiver sensitivity, CC1101 compatible mode, 1.2 kbps | GFSK, 5.2-kHz deviation (commonly used settings on CC1101), 49-kHz RX bandwidth, $\text{BER} = 10^{-2}$ | | -117 | | dBm |
| Selectivity, $\pm 100\text{ kHz}$, CC1101 compatible mode, 1.2 kbps | Wanted signal 3 dB above sensitivity limit. 1.2 kbps, GFSK, 5.2-kHz deviation (commonly used settings on CC1101), 49-kHz RX bandwidth, $\text{BER} = 10^{-2}$ | | 45, 44 | | dB |
| Selectivity, $\pm 200\text{ kHz}$, CC1101 compatible mode, 1.2 kbps | Wanted signal 3 dB above sensitivity limit. 1.2 kbps, GFSK, 5.2-kHz deviation (commonly used settings on CC1101), 49-kHz RX bandwidth, $\text{BER} = 10^{-2}$ | | 51, 47 | | dB |
| Blocking, $\pm 2\text{ MHz}$, CC1101 compatible mode, 1.2 kbps | Wanted signal 3 dB above sensitivity limit. 1.2 kbps, GFSK, 5.2-kHz deviation (commonly used settings on CC1101), 49-kHz RX bandwidth, $\text{BER} = 10^{-2}$ | | 63, 62 | | dB |
| Blocking, $\pm 10\text{ MHz}$, CC1101 compatible mode, 1.2 kbps | Wanted signal 3 dB above sensitivity limit. 1.2 kbps, GFSK, 5.2-kHz deviation (commonly used settings on CC1101), 49-kHz RX bandwidth, $\text{BER} = 10^{-2}$ | | 81, 81 | | dB |
| Image rejection (image compensation enabled, the image compensation is calibrated in production), CC1101 compatible mode, 1.2 kbps | Wanted signal 3 dB above sensitivity limit. 1.2 kbps, GFSK, 5.2-kHz deviation (commonly used settings on CC1101), 49-kHz RX bandwidth, $\text{BER} = 10^{-2}$ | | 45 | | dB |
| Receiver sensitivity, legacy long-range mode, 625 bps | 10 ksym/s, GFSK, 5-kHz deviation, FEC (half rate), DSSS = 8, 40-kHz RX bandwidth, $\text{BER} = 10^{-2}$. 868 MHz and 915 MHz. | | -124 | | dBm |
| Selectivity, $\pm 100\text{ kHz}$, legacy long-range mode, 625 bps | Wanted signal 3 dB above sensitivity limit. 10 ksym/s, GFSK, 5-kHz deviation, FEC (half rate), DSSS = 8, 40-kHz RX bandwidth, $\text{BER} = 10^{-2}$ | | 56, 56 | | dB |
| Selectivity, $\pm 200\text{ kHz}$, legacy long-range mode, 625 bps | Wanted signal 3 dB above sensitivity limit. 10 ksym/s, GFSK, 5-kHz deviation, FEC (half rate), DSSS = 8, 40-kHz RX bandwidth, $\text{BER} = 10^{-2}$ | | 62, 65 | | dB |
| Blocking $\pm 1\text{ MHz}$, legacy long-range mode, 625 bps | Wanted signal 3 dB above sensitivity limit. 10 ksym/s, GFSK, 5-kHz deviation, FEC (half rate), DSSS = 8, 40-kHz RX bandwidth, $\text{BER} = 10^{-2}$ | | 73, 77 | | dB |
| Blocking $\pm 2\text{ MHz}$, legacy long-range mode, 625 bps | Wanted signal 3 dB above sensitivity limit. 10 ksym/s, GFSK, 5-kHz deviation, FEC (half rate), DSSS = 8, 40-kHz RX bandwidth, $\text{BER} = 10^{-2}$ | | 79, 79 | | dB |
| Blocking $\pm 10\text{ MHz}$, legacy long-range mode, 625 bps | Wanted signal 3 dB above sensitivity limit. 10 ksym/s, GFSK, 5-kHz deviation, FEC (half rate), DSSS = 8, 40-kHz RX bandwidth, $\text{BER} = 10^{-2}$ | | 91, 91 | | dB |
| Receiver sensitivity, OOK, 4.8 kbps | 4.8 kbps, OOK, 40-kHz RX bandwidth, $\text{BER} = 10^{-2}$. 868 MHz and 915 MHz | | -115 | | dBm |

5.7 Receive (RX) Parameters, 431 MHz to 527 MHz

Measured on the Texas Instruments CC1310EM-7XD-4251 reference design with $T_c = 25^\circ\text{C}$, $V_{\text{DD5}} = 3.0\text{ V}$, DC/DC enabled, $f_{\text{RF}} = 433.92\text{ MHz}$, unless otherwise noted. All measurements are performed at the antenna input with a combined RX and TX path. This frequency band is supported on die Revision B and later.

| PARAMETER | TEST CONDITIONS | MIN | TYP | MAX | UNIT |
|---|--|-----|--------|-----|------|
| Receiver sensitivity, 50 kbps | 50 kbps, GFSK, 25-kHz deviation, 100-kHz RX bandwidth (same modulation format as IEEE 802.15.4g mandatory mode), BER = 10^{-2} | | -110 | | dBm |
| Receiver saturation | 50 kbps, GFSK, 25-kHz deviation, 100-kHz RX bandwidth (same modulation format as IEEE 802.15.4g mandatory mode), BER = 10^{-2} | | 10 | | dBm |
| Selectivity, $\pm 200\text{ kHz}$, 50 kbps | Wanted signal 3 dB above sensitivity limit. 50 kbps, GFSK, 25-kHz deviation, 100-kHz RX bandwidth (same modulation format as IEEE 802.15.4g mandatory mode), BER = 10^{-2} | | 40, 42 | | dB |
| Selectivity, $\pm 400\text{ kHz}$, 50 kbps | Wanted signal 3 dB above sensitivity limit. 50 kbps, GFSK, 25-kHz deviation, 100-kHz RX bandwidth (same modulation format as IEEE 802.15.4g mandatory mode), BER = 10^{-2} | | 42, 50 | | dB |
| Blocking $\pm 1\text{ MHz}$, 50 kbps | Wanted signal 3 dB above sensitivity limit. 50 kbps, GFSK, 25-kHz deviation, 100-kHz RX bandwidth (same modulation format as IEEE 802.15.4g mandatory mode), BER = 10^{-2} | | 53, 58 | | dB |
| Blocking $\pm 2\text{ MHz}$, 50 kbps | Wanted signal 3 dB above sensitivity limit. 50 kbps, GFSK, 25-kHz deviation, 100-kHz RX bandwidth (same modulation format as IEEE 802.15.4g mandatory mode), BER = 10^{-2} | | 59, 60 | | dB |
| Blocking $\pm 10\text{ MHz}$, 50 kbps | Wanted signal 3 dB above sensitivity limit. 50 kbps, GFSK, 25-kHz deviation, 100-kHz RX bandwidth (same modulation format as IEEE 802.15.4g mandatory mode), BER = 10^{-2} | | 74, 74 | | dB |
| Spurious emissions 1 GHz to 13 GHz (VCO leakage at 3.5 GHz) and 30 MHz to 1 GHz | Conducted emissions measured according to ETSI EN 300 220 | | -74 | | dBm |
| Image rejection (image compensation enabled, the image compensation is calibrated in production), 50 kbps | Wanted signal 3 dB above sensitivity limit. 50 kbps, GFSK, 25-kHz deviation, 100-kHz RX bandwidth (same modulation format as IEEE 802.15.4g mandatory mode), BER = 10^{-2} | | 43 | | dB |
| Receiver sensitivity, long-range mode, 5 kbps | 20 ksym/s, GFSK, 5-kHz deviation, FEC (half rate), DSSS = 2, 49-kHz RX bandwidth, BER = 10^{-2} . 433 MHz | | -119 | | dBm |
| Receiver sensitivity, long-range mode, 2.5 kbps | 20 ksym/s, GFSK, 5-kHz deviation, FEC (half rate), DSSS = 4, 49-kHz RX bandwidth, BER = 10^{-2} . 433 MHz | | -120 | | dBm |
| Receiver sensitivity, long-range mode, 1.25 kbps | 20 ksym/s, GFSK, 5-kHz deviation, FEC (half rate), DSSS = 8, 49-kHz RX bandwidth, BER = 10^{-2} . 433 MHz | | -121 | | dBm |
| Receiver sensitivity, legacy long-range mode, 625 bps | 10 ksym/s, GFSK, 5-kHz deviation, FEC (half rate), DSSS = 8, 40-kHz RX bandwidth, BER = 10^{-2} . 868 MHz and 915 MHz. | | -124 | | dBm |
| Selectivity, $\pm 100\text{ kHz}$, legacy long-range mode, 625 bps | Wanted signal 3 dB above sensitivity limit. 10 ksym/s, GFSK, 5-kHz deviation, FEC (half rate), DSSS = 8, 40-kHz RX bandwidth, BER = 10^{-2} | | 57, 58 | | dB |
| Selectivity, $\pm 200\text{ kHz}$, legacy long-range mode, 625 bps | Wanted signal 3 dB above sensitivity limit. 10 ksym/s, GFSK, 5-kHz deviation, FEC (half rate), DSSS = 8, 40-kHz RX bandwidth, BER = 10^{-2} | | 56, 60 | | dB |
| Blocking $\pm 1\text{ MHz}$, legacy long-range mode, 625 bps | Wanted signal 3 dB above sensitivity limit. 10 ksym/s, GFSK, 5-kHz deviation, FEC (half rate), DSSS = 8, 40-kHz RX bandwidth, BER = 10^{-2} | | 68, 73 | | dB |
| Blocking $\pm 2\text{ MHz}$, legacy long-range mode, 625 bps | Wanted signal 3 dB above sensitivity limit. 10 ksym/s, GFSK, 5-kHz deviation, FEC (half rate), DSSS = 8, 40-kHz RX bandwidth, BER = 10^{-2} | | 74, 74 | | dB |
| Blocking $\pm 10\text{ MHz}$, legacy long-range mode, 625 bps | Wanted signal 3 dB above sensitivity limit. 10 ksym/s, GFSK, 5-kHz deviation, FEC (half rate), DSSS = 8, 40-kHz RX bandwidth, BER = 10^{-2} | | 88, 89 | | dB |

Receive (RX) Parameters, 431 MHz to 527 MHz (continued)

Measured on the Texas Instruments CC1310EM-7XD-4251 reference design with $T_c = 25^\circ\text{C}$, $V_{\text{DDS}} = 3.0\text{ V}$, DC/DC enabled, $f_{\text{RF}} = 433.92\text{ MHz}$, unless otherwise noted. All measurements are performed at the antenna input with a combined RX and TX path. This frequency band is supported on die Revision B and later.

| PARAMETER | TEST CONDITIONS | MIN | TYP | MAX | UNIT |
|---|---|-----|-----|-----|------|
| Image rejection (image compensation enabled, the image compensation is calibrated in production), legacy long-range mode, 625 bps | Wanted signal 3 dB above sensitivity limit. 10 ksym/s, GFSK, 5-kHz deviation, FEC (half rate), DSSS = 8, 40-kHz RX bandwidth, BER = 10^{-2} | | 55 | | dB |

5.8 Transmit (TX) Parameters, 861 MHz to 1054 MHz

Measured on the Texas Instruments CC1310EM-7XD-7793 reference design with $T_c = 25^\circ\text{C}$, $V_{\text{DD5}} = 3.0\text{ V}$, DC/DC enabled, $f_{\text{RF}} = 868\text{ MHz}$, unless otherwise noted. All measurements are performed at the antenna input with a combined RX and TX path.

| PARAMETER | | TEST CONDITIONS | MIN | TYP | MAX | UNIT |
|--|---|--|-----|----------|-----|------|
| Maximum output power, boost mode | | VDDR = 1.95 V Minimum VDDS for boost mode is 2.1 V 868 MHz and 915 MHz | | 14 | | dBm |
| Maximum output power | | 868 MHz and 915 MHz | | 12 | | dBm |
| Output power programmable range | | | | 24 | | dB |
| Output power variation | | Tested at +10-dBm setting | | ±0.9 | | dB |
| Output power variation, boost mode | | +14 dBm | | ±0.5 | | dB |
| Spurious emissions (excluding harmonics) ⁽¹⁾ | 30 MHz to 1 GHz | Transmitting +14 dBm ETSI restricted bands | | <-59 | | dBm |
| | | Transmitting +14 dBm outside ETSI restricted bands | | <-51 | | |
| | 1 GHz to 12.75 GHz | Transmitting +14 dBm measured in 1-MHz bandwidth (ETSI) | | <-37 | | |
| Harmonics | Second harmonic | Transmitting +14 dBm, conducted 868 MHz, 915 MHz | | -52, -55 | | dBm |
| | Third harmonic | Transmitting +14 dBm, conducted 868 MHz, 915 MHz | | -58, -55 | | |
| | Fourth harmonic | Transmitting +14 dBm, conducted 868 MHz, 915 MHz | | -56, -56 | | |
| Spurious emissions out-of-band, 915 MHz ⁽¹⁾ | 30 MHz to 88 MHz (within FCC restricted bands) | Transmitting +14 dBm, conducted | | <-66 | | dBm |
| | 88 MHz to 216 MHz (within FCC restricted bands) | Transmitting +14 dBm, conducted | | <-65 | | |
| | 216 MHz to 960 MHz (within FCC restricted bands) | Transmitting +14 dBm, conducted | | <-65 | | |
| | 960 MHz to 2390 MHz and above 2483.5 MHz (within FCC restricted band) | Transmitting +14 dBm, conducted | | <-52 | | |
| | 1 GHz to 12.75 GHz (outside FCC restricted bands) | Transmitting +14 dBm, conducted | | <-43 | | |
| Spurious emissions out-of-band, 920.6 MHz ⁽¹⁾ | Below 710 MHz (ARIB T-108) | Transmitting +14 dBm, conducted | | <-50 | | dBm |
| | 710 MHz to 900 MHz (ARIB T-108) | Transmitting +14 dBm, conducted | | <-60 | | |
| | 900 MHz to 915 MHz (ARIB T-108) | Transmitting +14 dBm, conducted | | <-57 | | |
| | 930 MHz to 1000 MHz (ARIB T-108) | Transmitting +14 dBm, conducted | | <-57 | | |
| | 1000 MHz to 1215 MHz (ARIB T-108) | Transmitting +14 dBm, conducted | | <-59 | | |
| | Above 1215 MHz (ARIB T-108) | Transmitting +14 dBm, conducted | | <-45 | | |

(1) Suitable for systems targeting compliance with EN 300 220, EN 54-25, EN 303 204, FCC CFR47 Part 15, ARIB STD-T108.

5.9 Transmit (TX) Parameters, 431 MHz to 527 MHz

Measured on the Texas Instruments CC1310EM-7XD-4251 reference design with $T_c = 25^\circ\text{C}$, $V_{\text{DD5}} = 3.0\text{ V}$, DC/DC enabled, $f_{\text{RF}} = 433.92\text{ MHz}$, unless otherwise noted. All measurements are performed at the antenna input with a combined RX and TX path. This frequency band is supported on die Revision B and later.

| PARAMETER | | TEST CONDITIONS | MIN | TYP | MAX | UNIT |
|--|--------------------|---|-----|------|-----|------|
| Maximum output power, boost mode | | VDDR = 1.95 V Minimum VDD5 for boost mode is 2.1 V | | 15 | | dBm |
| Maximum output power | | | | 14 | | dBm |
| Spurious emissions (excluding harmonics) ⁽¹⁾ | 30 MHz to 1 GHz | Transmitting +10 dBm, 433 MHz Inside ETSI restricted bands | | <-63 | | dBm |
| | | Transmitting +10 dBm, 433 MHz Outside ETSI restricted bands | | <-39 | | |
| | 1 GHz to 12.75 GHz | Transmitting +10 dBm, 433 MHz Outside ETSI restricted bands, measured in 1-MHz bandwidth (ETSI) | | <-52 | | |
| | | Transmitting +10 dBm, 433 MHz Inside ETSI restricted bands, measured in 1-MHz bandwidth (ETSI) | | <-58 | | |

(1) Suitable for systems targeting compliance with EN 300 220, EN 54-25, EN 303 204, FCC CFR47 Part 15, ARIB STD-T108.

5.10 PLL Parameters

Measured on the Texas Instruments CC1310EM-7XD-7793 reference design with $T_c = 25^\circ\text{C}$, $V_{\text{DD5}} = 3.0\text{ V}$

| PARAMETER | TEST CONDITIONS | MIN | TYP | MAX | UNIT |
|---------------------------------|-------------------|-----|------|-----|--------|
| Phase noise in the 868-MHz band | ±100-kHz offset | | -101 | | dBc/Hz |
| | ±200-kHz offset | | -108 | | |
| | ±400-kHz offset | | -115 | | |
| | ±1000-kHz offset | | -124 | | |
| | ±2000-kHz offset | | -131 | | |
| | ±10000-kHz offset | | -140 | | |
| Phase noise in the 915-MHz band | ±100-kHz offset | | -98 | | dBc/Hz |
| | ±200-kHz offset | | -106 | | |
| | ±400-kHz offset | | -114 | | |
| | ±1000-kHz offset | | -122 | | |
| | ±2000-kHz offset | | -130 | | |
| | ±10000-kHz offset | | -140 | | |

5.11 ADC Characteristics

$T_c = 25^\circ\text{C}$, $V_{\text{DD5}} = 3.0\text{ V}$, DC/DC disabled. Input voltage scaling enabled, unless otherwise noted.⁽¹⁾

| PARAMETER | TEST CONDITIONS | MIN | TYP | MAX | UNIT |
|---------------------|--|-----|-------|------------------|------------|
| Input voltage range | | 0 | | V_{DD5} | V |
| Resolution | | | 12 | | Bits |
| Sample rate | | | | 200 | ksamples/s |
| Offset | Internal 4.3-V equivalent reference ⁽²⁾ | | 2.1 | | LSB |
| Gain error | Internal 4.3-V equivalent reference ⁽²⁾ | | -0.14 | | LSB |
| DNL ⁽³⁾ | Differential nonlinearity | | >-1 | | LSB |
| INL ⁽⁴⁾ | Integral nonlinearity | | ±2 | | LSB |

(1) Using IEEE Std 1241™ 2010 for terminology and test methods.

(2) Input signal scaled down internally before conversion, as if voltage range was 0 to 4.3 V. Applied voltage must be within the absolute maximum ratings (see Section 5.1) at all times.

(3) No missing codes. Positive DNL typically varies from 0.3 to 1.7, depending on the device (see Figure 5-7).

(4) For a typical example, see Figure 5-6.

ADC Characteristics (continued)
 $T_c = 25^\circ\text{C}$, $V_{\text{DDS}} = 3.0\text{ V}$, DC/DC disabled. Input voltage scaling enabled, unless otherwise noted.⁽¹⁾

| PARAMETER | | TEST CONDITIONS | MIN | TYP | MAX | UNIT |
|---------------------|--------------------------------------|--|-----|-------------------------|-----|---------------|
| ENOB | Effective number of bits | Internal 4.3-V equivalent reference ⁽²⁾ , 200 ksamples/s, 9.6-kHz input tone | | 10.0 | | Bits |
| | | VDDS as reference, 200 ksamples/s, 9.6-kHz input tone | | 10.2 | | |
| | | Internal 1.44-V reference, voltage scaling disabled, 32 samples average, 200 ksamples/s, 300-Hz input tone | | 11.1 | | |
| THD | Total harmonic distortion | Internal 4.3-V equivalent reference ⁽²⁾ , 200 ksamples/s, 9.6-kHz input tone | | -65 | | dB |
| | | VDDS as reference, 200 ksamples/s, 9.6-kHz input tone | | -72 | | |
| | | Internal 1.44-V reference, voltage scaling disabled, 32 samples average, 200 ksamples/s, 300-Hz input tone | | -75 | | |
| SINAD and SNDR | Signal-to-noise and distortion ratio | Internal 4.3-V equivalent reference ⁽²⁾ , 200 ksamples/s, 9.6-kHz input tone | | 62 | | dB |
| | | VDDS as reference, 200 ksamples/s, 9.6-kHz input tone | | 63 | | |
| | | Internal 1.44-V reference, voltage scaling disabled, 32 samples average, 200 ksamples/s, 300-Hz input tone | | 69 | | |
| SFDR | Spurious-free dynamic range | Internal 4.3-V equivalent reference ⁽²⁾ , 200 ksamples/s, 9.6-kHz input tone | | 74 | | dB |
| | | VDDS as reference, 200 ksamples/s, 9.6-kHz input tone | | 75 | | |
| | | Internal 1.44-V reference, voltage scaling disabled, 32 samples average, 200 ksamples/s, 300-Hz input tone | | 75 | | |
| Conversion time | | Including sampling time | | 5 | | μs |
| Current consumption | | Internal 4.3-V equivalent reference ⁽²⁾ | | 0.66 | | mA |
| Current consumption | | VDDS as reference | | 0.75 | | mA |
| Reference voltage | | Equivalent fixed internal reference(voltage scaling enabled) ⁽²⁾ For best accuracy, the ADC conversion should be initiated through the TI-RTOS API in order to include the gain/offset compensation factors stored in FCFG1. | | 4.3 | | V |
| Reference voltage | | Fixed internal reference (input voltage scaling disabled). ⁽²⁾ For best accuracy, the ADC conversion should be initiated through the TI-RTOS API in order to include the gain/offset compensation factors stored in FCFG1. This value is derived from the scaled value (4.3 V) as follows: $V_{\text{ref}} = 4.3\text{ V} \times 1408 / 4095$ | | 1.48 | | V |
| Reference voltage | | VDDS as reference (Also known as RELATIVE) (input voltage scaling enabled) | | VDDS | | V |
| Reference voltage | | VDDS as reference (Also known as RELATIVE) (input voltage scaling disabled) | | $V_{\text{DDS}} / 2.82$ | | V |
| Input Impedance | | 200 ksamples/s, voltage scaling enabled. Capacitive input, input impedance depends on sampling frequency and sampling time | | >1 | | M Ω |

5.12 Temperature Sensor

Measured on the Texas Instruments CC1310EM-7XD-7793 reference design with $T_c = 25^\circ\text{C}$, $V_{\text{DDS}} = 3.0\text{ V}$, unless otherwise noted.

| PARAMETER | TEST CONDITIONS | MIN | TYP | MAX | UNIT |
|---|-----------------|-----|---------|-----|---------------------------|
| Resolution | | | 4 | | $^\circ\text{C}$ |
| Range | | -40 | | 85 | $^\circ\text{C}$ |
| Accuracy | | | ± 5 | | $^\circ\text{C}$ |
| Supply voltage coefficient ⁽¹⁾ | | | 3.2 | | $^\circ\text{C}/\text{V}$ |

(1) Automatically compensated when using supplied driver libraries.

5.13 Battery Monitor

Measured on the Texas Instruments CC1310EM-7XD-7793 reference design with $T_c = 25^\circ\text{C}$, $V_{\text{DDS}} = 3.0\text{ V}$, unless otherwise noted.

| PARAMETER | TEST CONDITIONS | MIN | TYP | MAX | UNIT |
|------------|-----------------|-----|-----|-----|------|
| Resolution | | | 50 | | mV |
| Range | | 1.8 | | 3.8 | V |
| Accuracy | | | 13 | | mV |

5.14 Continuous Time Comparator

$T_c = 25^\circ\text{C}$, $V_{\text{DDS}} = 3.0\text{ V}$, unless otherwise noted.

| PARAMETER | TEST CONDITIONS | MIN | TYP | MAX | UNIT |
|---|---------------------------|-----|------|------------------|---------------|
| Input voltage range | | 0 | | V_{DDS} | V |
| External reference voltage | | 0 | | V_{DDS} | V |
| Internal reference voltage | DCOUPPL as reference | | 1.27 | | V |
| Offset | | | 3 | | mV |
| Hysteresis | | | <2 | | mV |
| Decision time | Step from -10 mV to 10 mV | | 0.72 | | μs |
| Current consumption when enabled ⁽¹⁾ | | | 8.6 | | μA |

(1) Additionally, the bias module must be enabled when running in standby mode.

5.15 Low-Power Clocked Comparator

$T_c = 25^\circ\text{C}$, $V_{\text{DDS}} = 3.0\text{ V}$, unless otherwise noted.

| PARAMETER | TEST CONDITIONS | MIN | TYP | MAX | UNIT |
|--|---------------------------|--------------|------|------------------|-------------|
| Input voltage range | | 0 | | V_{DDS} | V |
| Clock frequency | | | 32.8 | | kHz |
| Internal reference voltage, $V_{\text{DDS}} / 2$ | | 1.49 to 1.51 | | | V |
| Internal reference voltage, $V_{\text{DDS}} / 3$ | | 1.01 to 1.03 | | | V |
| Internal reference voltage, $V_{\text{DDS}} / 4$ | | 0.78 to 0.79 | | | V |
| Internal reference voltage, DCOUPPL / 1 | | 1.25 to 1.28 | | | V |
| Internal reference voltage, DCOUPPL / 2 | | 0.63 to 0.65 | | | V |
| Internal reference voltage, DCOUPPL / 3 | | 0.42 to 0.44 | | | V |
| Internal reference voltage, DCOUPPL / 4 | | 0.33 to 0.34 | | | V |
| Offset | | | <2 | | mV |
| Hysteresis | | | <5 | | mV |
| Decision time | Step from -50 mV to 50 mV | | 1 | | clock-cycle |
| Current consumption when enabled | | | 362 | | nA |

5.16 Programmable Current Source

 $T_c = 25^\circ\text{C}$, $V_{\text{DDS}} = 3.0\text{ V}$, unless otherwise noted.

| PARAMETER | TEST CONDITIONS | MIN | TYP | MAX | UNIT |
|--|---|------------|-----|-----|---------------|
| Current source programmable output range | | 0.25 to 20 | | | μA |
| Resolution | | 0.25 | | | μA |
| Current consumption ⁽¹⁾ | Including current source at maximum programmable output | 23 | | | μA |

(1) Additionally, the bias module must be enabled when running in standby mode.

5.17 DC Characteristics

| PARAMETER | TEST CONDITIONS | MIN | TYP | MAX | UNIT |
|--|--|------|------|------|---------------------------------|
| $T_A = 25^\circ\text{C}$, $V_{\text{DDS}} = 1.8\text{ V}$ | | | | | |
| GPIO VOH at 8-mA load | IOCURR = 2, high-drive GPIOs only | 1.32 | 1.54 | | V |
| GPIO VOL at 8-mA load | IOCURR = 2, high-drive GPIOs only | | 0.26 | 0.32 | V |
| GPIO VOH at 4-mA load | IOCURR = 1 | 1.32 | 1.58 | | V |
| GPIO VOL at 4-mA load | IOCURR = 1 | | 0.21 | 0.32 | V |
| GPIO pullup current | Input mode, pullup enabled, $V_{\text{pad}} = 0\text{ V}$ | | 71.7 | | μA |
| GPIO pulldown current | Input mode, pulldown enabled, $V_{\text{pad}} = V_{\text{DDS}}$ | | 21.1 | | μA |
| GPIO high/low input transition, no hysteresis | IH = 0, transition between reading 0 and reading 1 | | 0.88 | | V |
| GPIO low-to-high input transition, with hysteresis | IH = 1, transition voltage for input read as 0 → 1 | | 1.07 | | V |
| GPIO high-to-low input transition, with hysteresis | IH = 1, transition voltage for input read as 1 → 0 | | 0.74 | | V |
| GPIO input hysteresis | IH = 1, difference between 0 → 1 and 1 → 0 voltage transition points | | 0.33 | | V |
| $T_A = 25^\circ\text{C}$, $V_{\text{DDS}} = 3.0\text{ V}$ | | | | | |
| GPIO VOH at 8-mA load | IOCURR = 2, high-drive GPIOs only | | 2.68 | | V |
| GPIO VOL at 8-mA load | IOCURR = 2, high-drive GPIOs only | | 0.33 | | V |
| GPIO VOH at 4-mA load | IOCURR = 1 | | 2.72 | | V |
| GPIO VOL at 4-mA load | IOCURR = 1 | | 0.28 | | V |
| $T_A = 25^\circ\text{C}$, $V_{\text{DDS}} = 3.8\text{ V}$ | | | | | |
| GPIO pullup current | Input mode, pullup enabled, $V_{\text{pad}} = 0\text{ V}$ | | 277 | | μA |
| GPIO pulldown current | Input mode, pulldown enabled, $V_{\text{pad}} = V_{\text{DDS}}$ | | 113 | | μA |
| GPIO high/low input transition, no hysteresis | IH = 0, transition between reading 0 and reading 1 | | 1.67 | | V |
| GPIO low-to-high input transition, with hysteresis | IH = 1, transition voltage for input read as 0 → 1 | | 1.94 | | V |
| GPIO high-to-low input transition, with hysteresis | IH = 1, transition voltage for input read as 1 → 0 | | 1.54 | | V |
| GPIO input hysteresis | IH = 1, difference between 0 → 1 and 1 → 0 voltage transition points | | 0.4 | | V |
| VIH | Lowest GPIO input voltage reliably interpreted as a <i>High</i> | | | 0.8 | V_{DDS} ⁽¹⁾ |
| VIL | Highest GPIO input voltage reliably interpreted as a <i>Low</i> | 0.2 | | | V_{DDS} ⁽¹⁾ |

(1) Each GPIO is referenced to a specific V_{DDS} pin. See the technical reference manual listed in [Section 8.3](#) for more details.

5.18 Thermal Characteristics

| THERMAL METRIC ⁽¹⁾ | CC1310 | | | UNIT ⁽²⁾ |
|---|---------------|---------------|---------------|---------------------|
| | RSM (VQFN) | RHB (VQFN) | RGZ (VQFN) | |
| | 32 PINS | 32 PINS | 48 PINS | |
| $R_{\theta JA}$ Junction-to-ambient thermal resistance | 36.9 | 32.8 | 29.6 | °C/W |
| $R_{\theta JC(top)}$ Junction-to-case (top) thermal resistance | 30.3 | 24.0 | 15.7 | °C/W |
| $R_{\theta JB}$ Junction-to-board thermal resistance | 7.6 | 6.8 | 6.2 | °C/W |
| Ψ_{JT} Junction-to-top characterization parameter | 0.4 | 0.3 | 0.3 | °C/W |
| Ψ_{JB} Junction-to-board characterization parameter | 7.4 | 6.8 | 6.2 | °C/W |
| $R_{\theta JC(bot)}$ Junction-to-case (bottom) thermal resistance | 2.1 | 1.9 | 1.9 | °C/W |

(1) For more information about traditional and new thermal metrics, see [Semiconductor and IC Package Thermal Metrics](#).

(2) °C/W = degrees Celsius per watt.

5.19 Timing and Switching Characteristics

5.19.1 Reset Timing

Table 5-1. Reset Timing

| PARAMETER | MIN | TYP | MAX | UNIT |
|----------------------|-----|-----|-----|------|
| RESET_N low duration | 1 | | | μs |

5.19.2 Wakeup Timing

Table 5-2. Wakeup Timing

Measured on the Texas Instruments CC1310EM-7XD-7793 reference design with $T_c = 25^\circ\text{C}$, $V_{DD5} = 3.0\text{ V}$, unless otherwise noted. The times listed here do not include RTOS overhead.

| PARAMETER | TEST CONDITIONS | MIN | TYP | MAX | UNIT |
|------------------------|-----------------|-----|------|-----|------|
| MCU, Idle → Active | | | 14 | | μs |
| MCU, Standby → Active | | | 174 | | μs |
| MCU, Shutdown → Active | | | 1097 | | μs |

5.19.3 Clock Specifications

Table 5-3. 24-MHz Crystal Oscillator (XOSC_HF)
 $T_c = 25^\circ\text{C}$, $V_{\text{DDS}} = 3.0\text{ V}$, unless otherwise noted. [Section 5.19.1](#)

| PARAMETER | TEST CONDITIONS | MIN | TYP | MAX | UNIT |
|---|--|-----|---------------------------------|-----|---------------|
| ESR equivalent series resistance Section 5.19.2 | $6\text{ pF} < C_L \leq 9\text{ pF}$ | | 20 | 60 | Ω |
| ESR equivalent series resistance Section 5.19.2 | $5\text{ pF} < C_L \leq 6\text{ pF}$ | | | 80 | Ω |
| L_M motional inductance Section 5.19.2 | Relates to load capacitance (C_L in Farads) | | $< 1.6 \times 10^{-24} / C_L^2$ | | H |
| C_L crystal load capacitance Section 5.19.2 | | 5 | | 9 | pF |
| Crystal frequency Section 5.19.2 | | | 24 | | MHz |
| Start-up time | | | 150 | | μs |

Table 5-4. 32.768-kHz Crystal Oscillator (XOSC_LF)

Measured on the Texas Instruments CC1310EM-7XD-7793 reference design with $T_c = 25^\circ\text{C}$, $V_{\text{DDS}} = 3.0\text{ V}$, unless otherwise noted. ⁽¹⁾

| | MIN | TYP | MAX | UNIT |
|------------------------------------|-----|--------|-----|------------|
| Crystal frequency | | 32.768 | | kHz |
| ESR equivalent series resistance | | 30 | 100 | k Ω |
| Crystal load capacitance (C_L) | 6 | | 12 | pF |

⁽¹⁾ Probing or otherwise stopping the crystal while the DC/DC converter is enabled may cause permanent damage to the device.

Table 5-5. 48-MHz RC Oscillator (RCOSC_HF)

Measured on the Texas Instruments CC1310EM-7XD-7793 reference design with $T_c = 25^\circ\text{C}$, $V_{\text{DDS}} = 3.0\text{ V}$, unless otherwise noted.

| | MIN | TYP | MAX | UNIT |
|--|-----|--------------|-----|---------------|
| Frequency | | 48 | | MHz |
| Uncalibrated frequency accuracy | | $\pm 1\%$ | | |
| Calibrated frequency accuracy ⁽¹⁾ | | $\pm 0.25\%$ | | |
| Startup time | | 5 | | μs |

⁽¹⁾ Accuracy relative to the calibration source (XOSC_HF)

Table 5-6. 32-kHz RC Oscillator (RCOSC_LF)

Measured on the Texas Instruments CC1310EM-7XD-7793 reference design with $T_c = 25^\circ\text{C}$, $V_{\text{DDS}} = 3.0\text{ V}$, unless otherwise noted.

| | MIN | TYP | MAX | UNIT |
|-------------------------------------|-----|--------|-----|-----------------------|
| Calibrated frequency ⁽¹⁾ | | 32.768 | | kHz |
| Temperature coefficient | | 50 | | ppm/ $^\circ\text{C}$ |

⁽¹⁾ The frequency accuracy of the Real Time Clock (RTC) is not directly dependent on the frequency accuracy of the 32-kHz RC Oscillator. The RTC can be calibrated by measuring the frequency error of RCOSC_LF relative to XOSC_HF and compensating for the RTC tick speed.

5.19.4 Flash Memory Characteristics

Table 5-7. Flash Memory Characteristics

T_c = 25°C, V_{DD5} = 3.0 V, unless otherwise noted.

| PARAMETER | TEST CONDITIONS | MIN | TYP | MAX | UNIT |
|--|--|-----|------|-----|----------|
| Supported flash erase cycles before failure | | 100 | | | k Cycles |
| Flash page or sector erase current | Average delta current | | 12.6 | | mA |
| Flash page or sector erase time ⁽¹⁾ | | | 8 | | ms |
| Flash page or sector size | | | 4 | | KB |
| Flash write current | Average delta current, 4 bytes at a time | | 8.15 | | mA |
| Flash write time ⁽¹⁾ | 4 bytes at a time | | 8 | | µs |

(1) This number is dependent on flash aging and increases over time and erase cycles.

5.19.5 Synchronous Serial Interface (SSI) Characteristics

Table 5-8. Synchronous Serial Interface (SSI) Characteristics

T_c = 25°C, V_{DD5} = 3.0 V, unless otherwise noted.

| PARAMETER NO. | PARAMETER | MIN | TYP | MAX | UNIT |
|-------------------|--|-----|----------------------------|-------|---------------|
| S1 | t _{clk_per} SSIClk cycle time | 12 | | 65024 | system clocks |
| S2 ⁽¹⁾ | t _{clk_high} SSIClk high time | | 0.5 × t _{clk_per} | | |
| S3 ⁽¹⁾ | t _{clk_low} SSIClk low time | | 0.5 × t _{clk_per} | | |

(1) See the SSI timing diagrams, [Figure 5-1](#), [Figure 5-2](#), and [Figure 5-3](#).

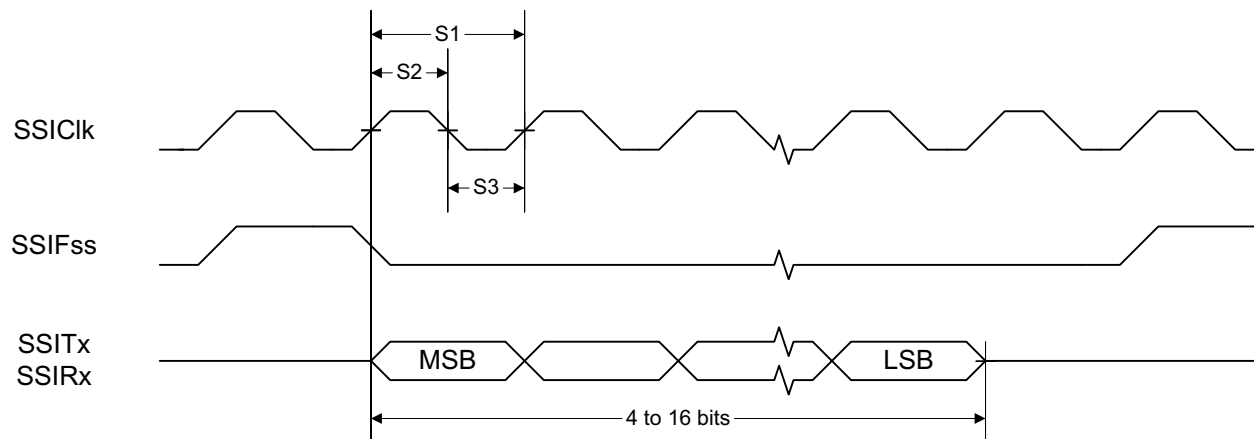

Figure 5-1. SSI Timing for TI Frame Format (FRF = 01), Single Transfer Timing Measurement

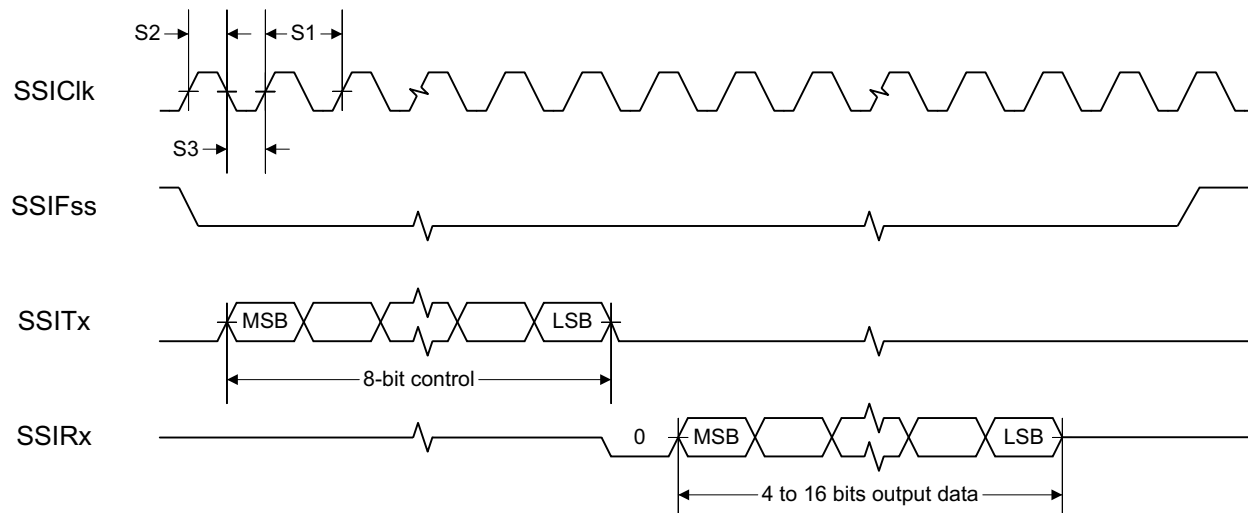

Figure 5-2. SSI Timing for MICROWIRE Frame Format (FRF = 10), Single Transfer

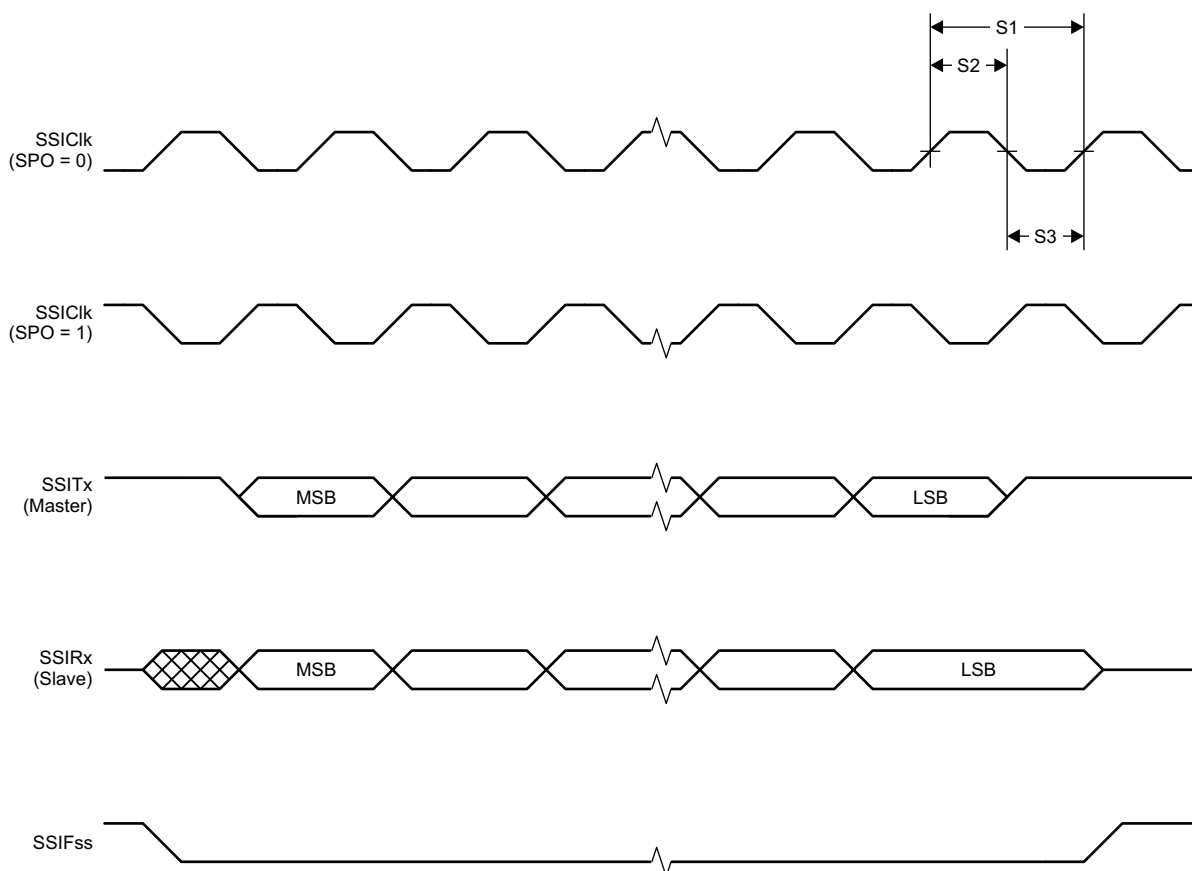

Figure 5-3. SSI Timing for SPI Frame Format (FRF = 00), With SPH = 1

5.20 Typical Characteristics

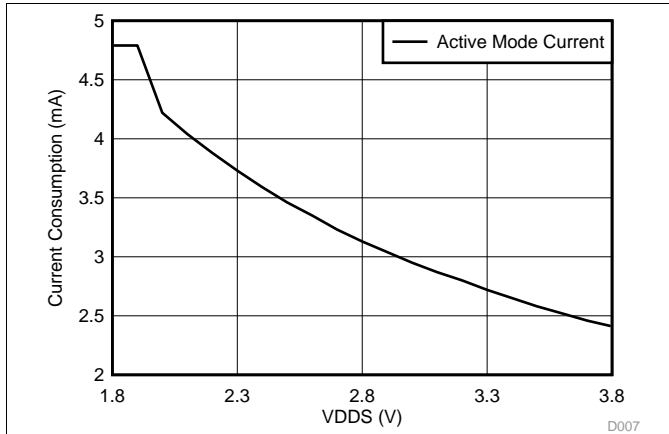

Figure 5-4. Active Mode (MCU) Current Consumption vs Supply Voltage (VDD5)

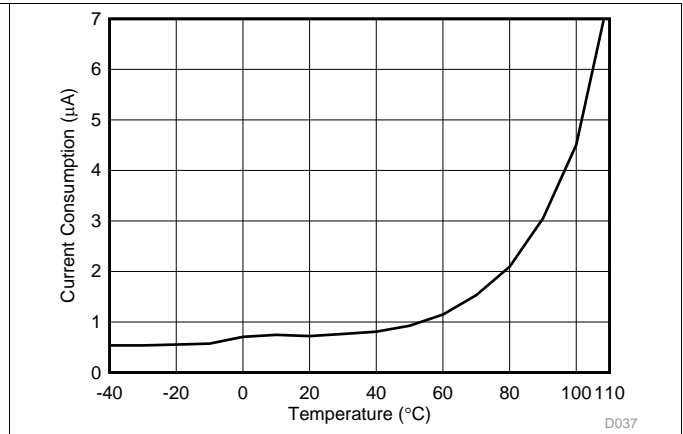

Figure 5-5. Standby MCU Current Consumption, 32-kHz Clock, RAM and MCU Retention

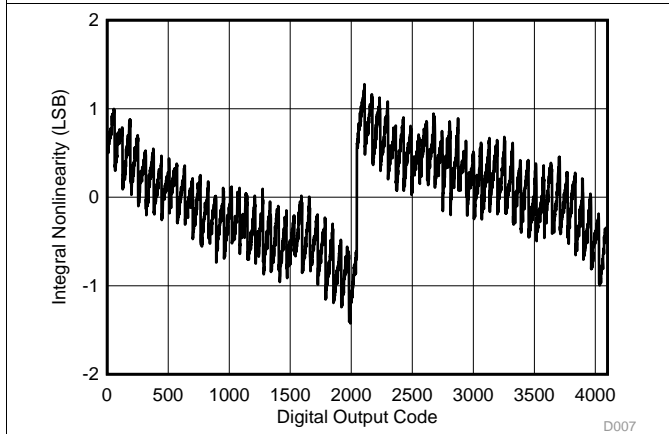

Figure 5-6. SoC ADC, Integral Nonlinearity vs Digital Output Code

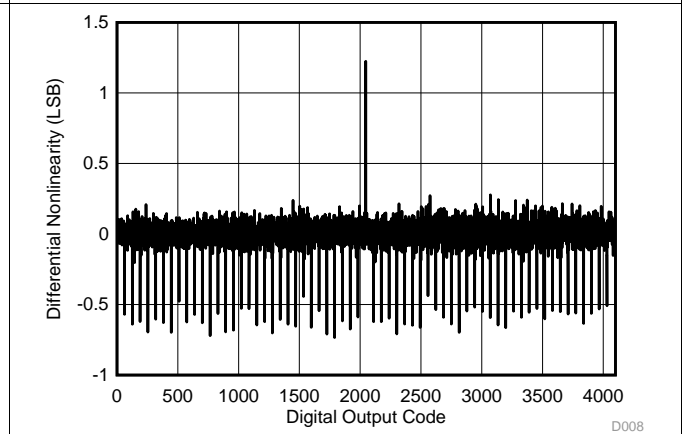

Figure 5-7. SoC ADC, Differential Nonlinearity vs Digital Output Code

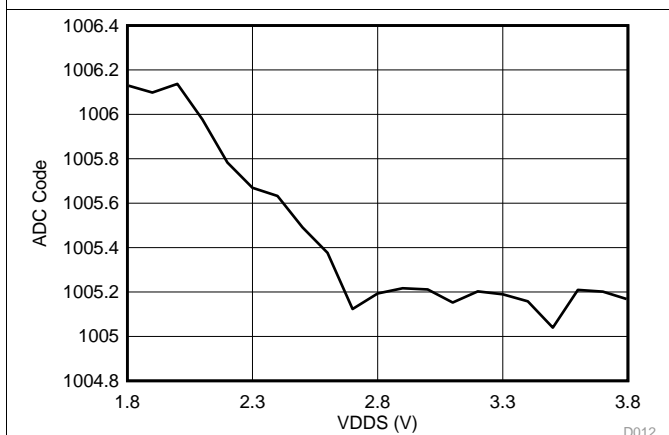

Figure 5-8. SoC ADC Output vs Supply Voltage (Fixed Input, Internal Reference, No Scaling)

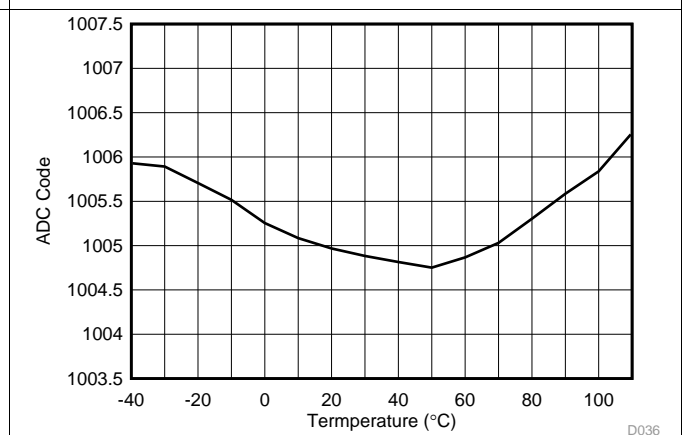

Figure 5-9. SoC ADC Output vs Temperature (Fixed Input, Internal Reference, No Scaling)

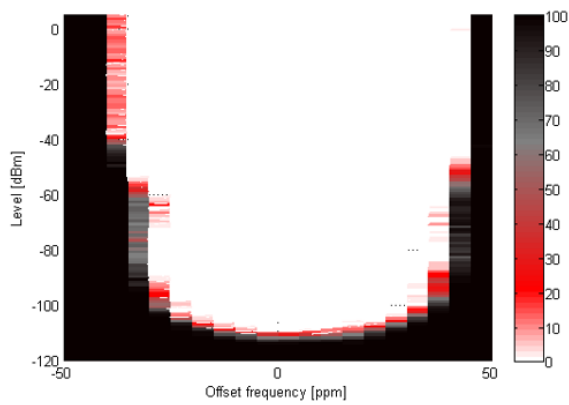

Figure 5-10. RX (50-kbps) Packet Error Rate (PER) vs Input RF Level vs Frequency Offset, 868 MHz

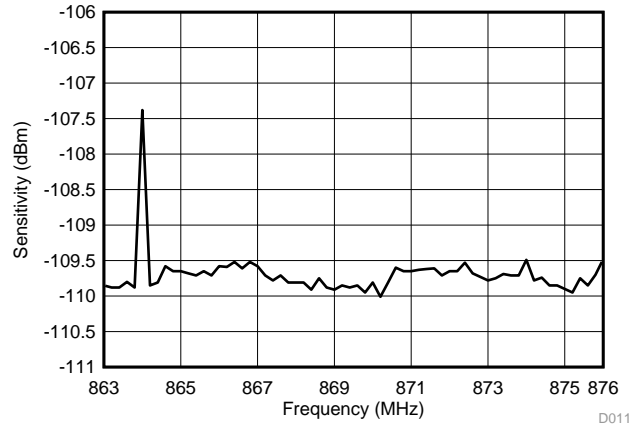

Figure 5-11. RX (50-kbps) Sensitivity vs Frequency

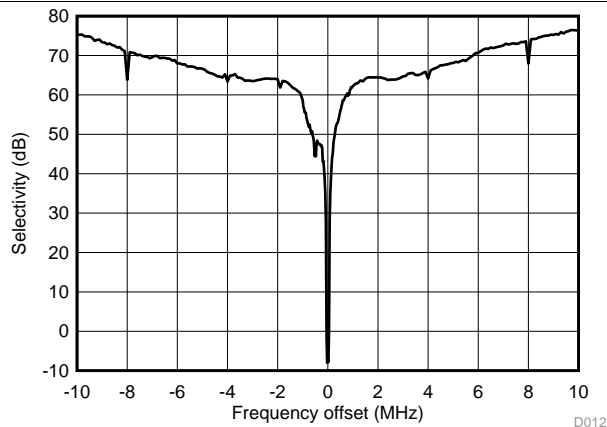

Figure 5-12. RX (50-kbps) Selectivity 868 MHz

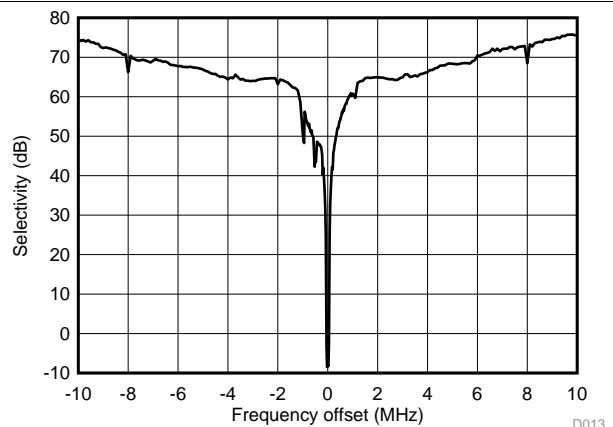

Figure 5-13. RX (50-kbps) Selectivity 915 MHz

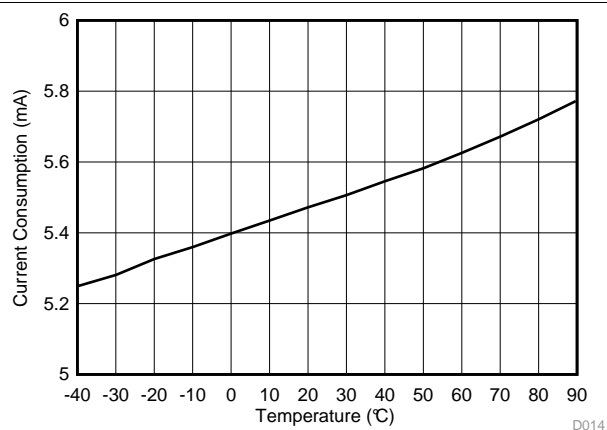

Figure 5-14. RX (50-kbps) Current Consumption vs Temperature 868 MHz

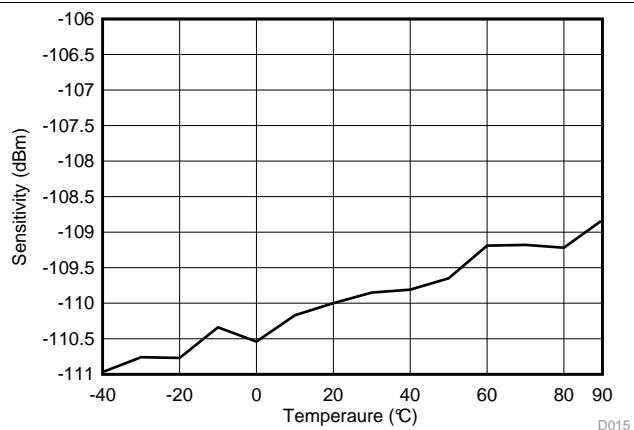

Figure 5-15. RX (50-kbps) Sensitivity vs Temperature 868 MHz

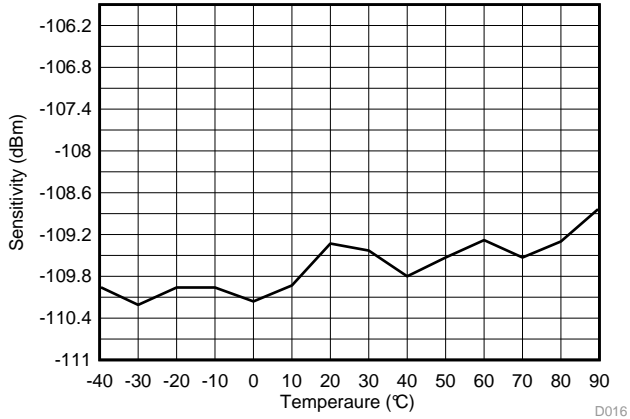

Figure 5-16. RX (50-kbps) Sensitivity vs Temperature 915 MHz

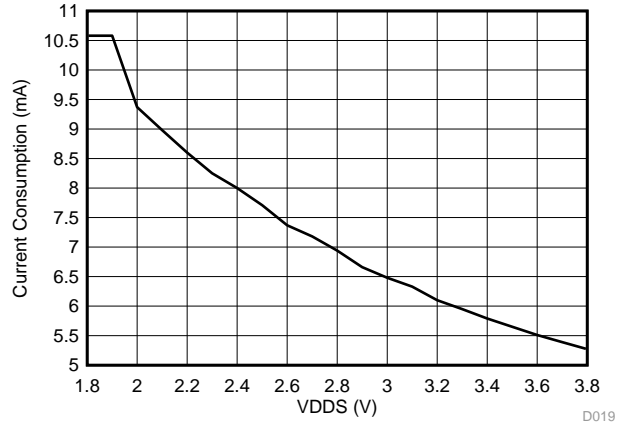

Figure 5-17. RX (50-kbps) Current Consumption vs Supply Voltage 915 MHz

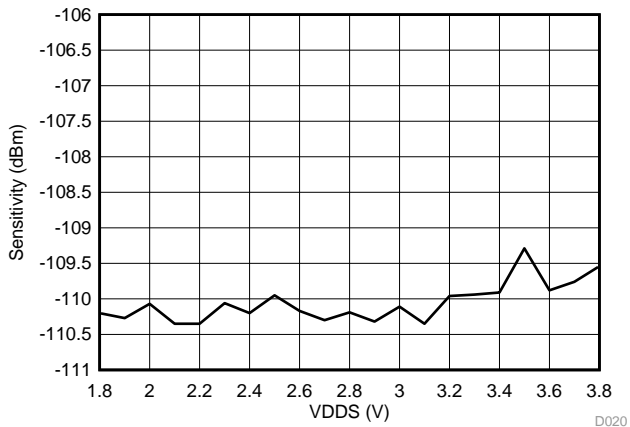

Figure 5-18. RX (50-kbps) Sensitivity vs Supply Voltage 868 MHz

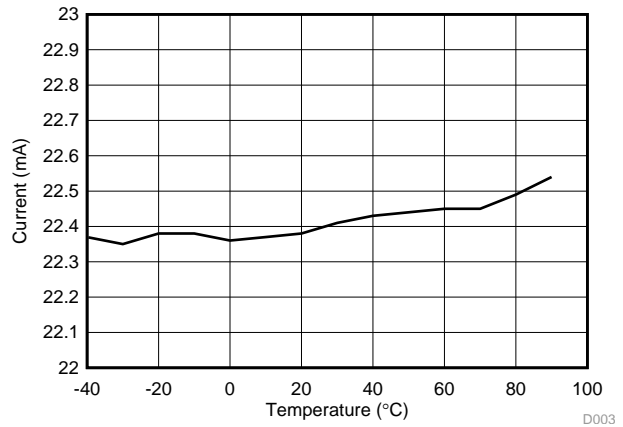

Figure 5-19. TX Current Consumption With Maximum Output Power vs Temperature 868 MHz

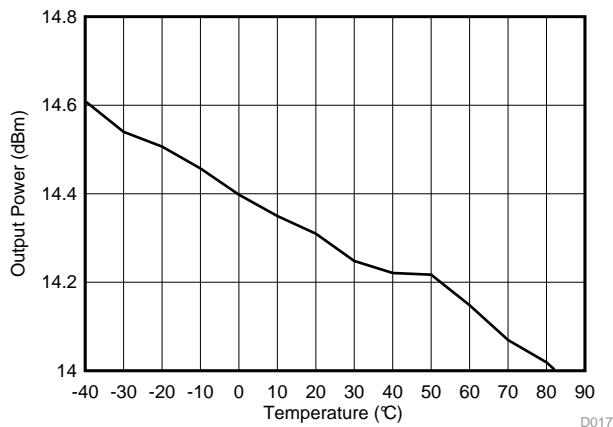

Figure 5-20. TX Maximum Output vs Temperature 868 MHz

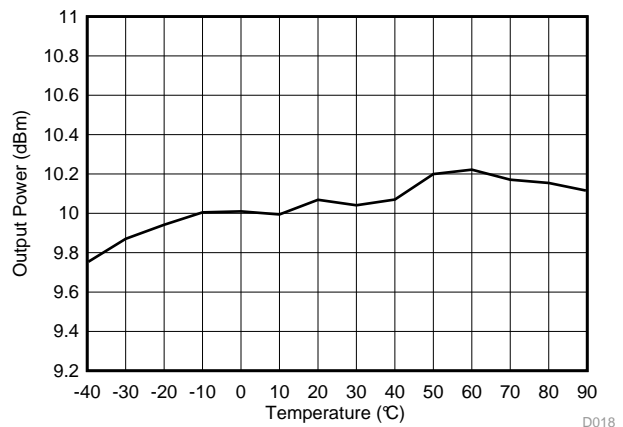

Figure 5-21. TX 10-dBm Output Power vs Temperature 868 MHz

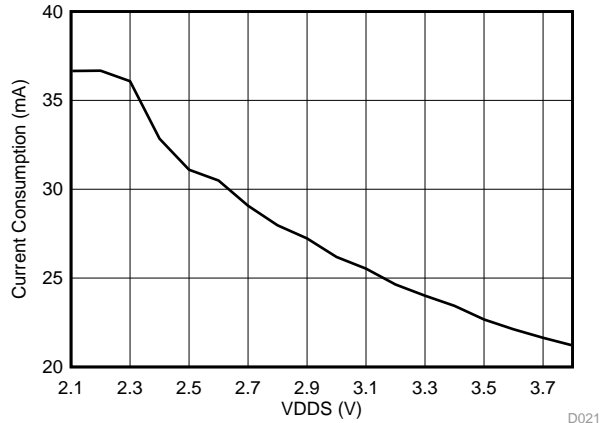

Figure 5-22. TX Current Consumption Maximum Output Power vs Supply Voltage 868 MHz

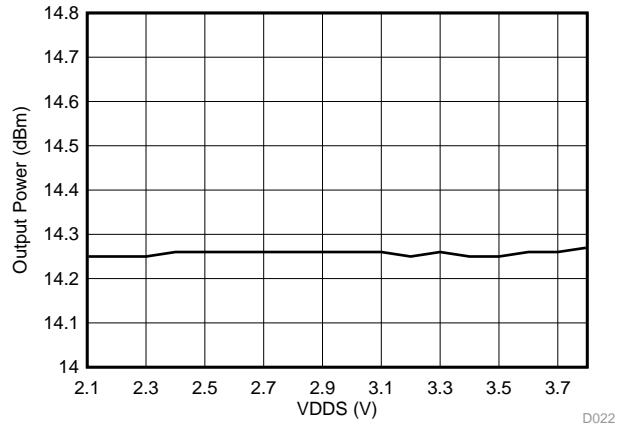

Figure 5-23. TX Maximum Output Power vs Supply Voltage 915 MHz

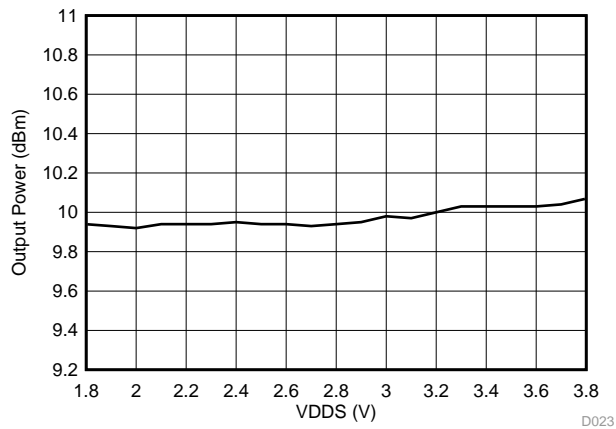

Figure 5-24. TX 10-dBm Output Power vs Supply Voltage 868 MHz

6 Detailed Description

6.1 Overview

[Section 1.4](#) shows a block diagram of the core modules of the CC13xx product family.

6.2 Main CPU

The CC1310 SimpleLink Wireless MCU contains an ARM Cortex-M3 (CM3) 32-bit CPU, which runs the application and the higher layers of the protocol stack.

The CM3 processor provides a high-performance, low-cost platform that meets the system requirements of minimal memory implementation and low-power consumption, while delivering outstanding computational performance and exceptional system response to interrupts.

The CM3 features include the following:

- 32-bit ARM Cortex-M3 architecture optimized for small-footprint embedded applications
- Outstanding processing performance combined with fast interrupt handling
- ARM Thumb[®]-2 mixed 16- and 32-bit instruction set delivers the high performance expected of a 32-bit ARM core in a compact memory size usually associated with 8- and 16-bit devices, typically in the range of a few kilobytes of memory for microcontroller-class applications:
 - Single-cycle multiply instruction and hardware divide
 - Atomic bit manipulation (bit-banding), delivering maximum memory use and streamlined peripheral control
 - Unaligned data access, enabling data to be efficiently packed into memory
- Fast code execution permits slower processor clock or increases sleep mode time
- Harvard architecture characterized by separate buses for instruction and data
- Efficient processor core, system, and memories
- Hardware division and fast digital-signal-processing oriented multiply accumulate
- Saturating arithmetic for signal processing
- Deterministic, high-performance interrupt handling for time-critical applications
- Enhanced system debug with extensive breakpoint and trace capabilities
- Serial wire trace reduces the number of pins required for debugging and tracing
- Migration from the ARM7[™] processor family for better performance and power efficiency
- Optimized for single-cycle flash memory use
- Ultra-low power consumption with integrated sleep modes
- 1.25 DMIPS per MHz

6.3 RF Core

The RF core is a highly flexible and capable radio system that interfaces the analog RF and baseband circuits, handles data to and from the system side, and assembles the information bits in a given packet structure.

The RF core can autonomously handle the time-critical aspects of the radio protocols, thus offloading the main CPU and leaving more resources for the user application. The RF core offers a high-level, command-based API to the main CPU.

The RF core supports a wide range of modulation formats, frequency bands, and accelerator features, which include the following:

- Wide range of data rates:
 - From 625 bps (offering long range and high robustness) to as high as 4 Mbps
- Wide range of modulation formats:
 - Multilevel (G) FSK and MSK
 - On-Off Keying (OOK) with optimized shaping to minimize adjacent channel leakage
 - Coding-gain support for long range
- Dedicated packet handling accelerators:
 - Forward error correction
 - Data whitening
 - 802.15.4g mode-switch support
 - Automatic CRC
- Automatic listen-before-talk (LBT) and clear channel assist (CCA)
- Digital RSSI
- Highly configurable channel filtering, supporting channel spacing schemes from 40 kHz to 4 MHz
- High degree of flexibility, offering a future-proof solution

The RF core interfaces a highly flexible radio, with a high-performance synthesizer that can support a wide range of frequency bands.

6.4 Sensor Controller

The Sensor Controller contains circuitry that can be selectively enabled in standby mode. The peripherals in this domain may be controlled by the Sensor Controller Engine, which is a proprietary power-optimized CPU. This CPU can read and monitor sensors or perform other tasks autonomously; thereby significantly reducing power consumption and offloading the main CM3 CPU.

A PC-based development tool called [Sensor Controller Studio](#) is used to write, test, and debug code for the Sensor Controller. The tool produces C driver source code, which the System CPU application uses to control and exchange data with the Sensor Controller. Typical use cases may be (but are not limited to) the following:

- Analog sensors using integrated ADC
- Digital sensors using GPIOs with bit-banged I²C or SPI
- Capacitive sensing
- Waveform generation
- Pulse counting
- Key scan
- Quadrature decoder for polling rotational sensors

The peripherals in the Sensor Controller include the following:

- The low-power clocked comparator can be used to wake the device from any state in which the comparator is active. A configurable internal reference can be used with the comparator. The output of the comparator can also be used to trigger an interrupt or the ADC.
- Capacitive sensing functionality is implemented through the use of a constant current source, a time-to-digital converter, and a comparator. The continuous time comparator in this block can also be used as a higher-accuracy alternative to the low-power clocked comparator. The Sensor Controller takes care of baseline tracking, hysteresis, filtering, and other related functions.
- The ADC is a 12-bit, 200-ksamples/s ADC with 8 inputs and a built-in voltage reference. The ADC can be triggered by many different sources, including timers, I/O pins, software, the analog comparator, and the RTC.
- The analog modules can be connected to up to eight different GPIOs (see [Table 6-1](#)).

The peripherals in the Sensor Controller can also be controlled from the main application processor.

Table 6-1. GPIOs Connected to the Sensor Controller⁽¹⁾

| ANALOG CAPABLE | CC13x0 | | |
|----------------|-------------------------|-------------------------|-------------------------|
| | 7 × 7 RGZ DIO NUMBER | 5 × 5 RHB DIO NUMBER | 4 × 4 RSM DIO NUMBER |
| Y | 30 | 14 | |
| Y | 29 | 13 | |
| Y | 28 | 12 | |
| Y | 27 | 11 | 9 |
| Y | 26 | 9 | 8 |
| Y | 25 | 10 | 7 |
| Y | 24 | 8 | 6 |
| Y | 23 | 7 | 5 |
| N | 7 | 4 | 2 |
| N | 6 | 3 | 1 |
| N | 5 | 2 | 0 |
| N | 4 | 1 | |
| N | 3 | 0 | |
| N | 2 | | |
| N | 1 | | |
| N | 0 | | |

(1) Depending on the package size, up to 15 pins can be connected to the Sensor Controller. Up to eight of these pins can be connected to analog modules.

6.5 Memory

The flash memory provides nonvolatile storage for code and data. The flash memory is in-system programmable.

The SRAM (static RAM) is split into two 4-KB blocks and two 6-KB blocks and can be used to store data and execute code. Retention of the RAM contents in standby mode can be enabled or disabled individually for each block to minimize power consumption. In addition, if flash cache is disabled, the 8-KB cache can be used as general-purpose RAM.

The ROM provides preprogrammed, embedded TI-RTOS kernel and Driverlib. The ROM also contains a bootloader that can be used to reprogram the device using SPI or UART.

6.6 Debug

The on-chip debug support is done through a dedicated cJTAG (IEEE 1149.7) or JTAG (IEEE 1149.1) interface.

6.7 Power Management

To minimize power consumption, the CC1310 device supports a number of power modes and power-management features (see [Table 6-2](#)).

Table 6-2. Power Modes

| MODE | SOFTWARE-CONFIGURABLE POWER MODES | | | | RESET PIN HELD |
|---|-----------------------------------|---------------------|----------------------------|--------------|----------------|
| | ACTIVE | IDLE | STANDBY | SHUTDOWN | |
| CPU | Active | Off | Off | Off | Off |
| Flash | On | Available | Off | Off | Off |
| SRAM | On | On | On | Off | Off |
| Radio | Available | Available | Off | Off | Off |
| Supply System | On | On | Duty Cycled | Off | Off |
| Current | 1.2 mA + 25.5 μ A/MHz | 570 μ A | 0.6 μ A | 185 nA | 0.1 μ A |
| Wake-up Time to CPU Active ⁽¹⁾ | – | 14 μ s | 174 μ s | 1015 μ s | 1015 μ s |
| Register Retention | Full | Full | Partial | No | No |
| SRAM Retention | Full | Full | Full | No | No |
| High-Speed Clock | XOSC_HF or RCOSC_HF | XOSC_HF or RCOSC_HF | Off | Off | Off |
| Low-Speed Clock | XOSC_LF or RCOSC_LF | XOSC_LF or RCOSC_LF | XOSC_LF or RCOSC_LF | Off | Off |
| Peripherals | Available | Available | Off | Off | Off |
| Sensor Controller | Available | Available | Available | Off | Off |
| Wake-up on RTC | Available | Available | Available | Off | Off |
| Wake-up on Pin Edge | Available | Available | Available | Available | Off |
| Wake-up on Reset Pin | Available | Available | Available | Available | Available |
| Brown Out Detector (BOD) | Active | Active | Duty Cycled ⁽²⁾ | Off | N/A |
| Power On Reset (POR) | Active | Active | Active | Active | N/A |

(1) Not including RTOS overhead.

(2) The Brown Out Detector is disabled between recharge periods in STANDBY. Lowering the supply voltage below the BOD threshold between two recharge periods while in STANDBY may cause the BOD to lock the device upon wakeup until a Reset/POR releases it. To avoid this, it is recommended that STANDBY mode is avoided if there is a risk that the supply voltage (VDD5) may drop below the specified operating voltage range. For the same reason, it is also good practice to ensure that a power cycling operation, such as a battery replacement, triggers a Power-on-reset by ensuring that the VDD5 decoupling network is fully depleted before applying supply voltage again (for example, inserting new batteries). This restriction does not apply to CC1310 die revision B or later.

In active mode, the application CM3 CPU is actively executing code. Active mode provides normal operation of the processor and all of the peripherals that are currently enabled. The system clock can be any available clock source (see [Table 6-2](#)).

In idle mode, all active peripherals can be clocked, but the Application CPU core and memory are not clocked and no code is executed. Any interrupt event returns the processor to active mode.

In standby mode, only the always-on (AON) domain is active. An external wake-up event, RTC event, or Sensor Controller event is required to return the device to active mode. MCU peripherals with retention do not need to be reconfigured when waking up again, and the CPU continues execution from where it went into standby mode. All GPIOs are latched in standby mode.

In shutdown mode, the device is entirely turned off (including the AON domain and Sensor Controller), and the I/Os are latched with the value they had before entering shutdown mode. A change of state on any I/O pin defined as a *wake from shutdown pin* wakes up the device and functions as a reset trigger. The CPU can differentiate between reset in this way and reset-by-reset pin or POR by reading the reset status register. The only state retained in this mode is the latched I/O state and the flash memory contents.

The Sensor Controller is an autonomous processor that can control the peripherals in the Sensor Controller independent of the main CPU. This means that the main CPU does not have to wake up, for example to execute an ADC sample or poll a digital sensor over SPI, thus saving both current and wake-up time that would otherwise be wasted. The Sensor Controller Studio lets the user configure the Sensor Controller and choose which peripherals are controlled and which conditions wake up the main CPU.

6.8 Clock Systems

The CC1310 device supports two external and two internal clock sources.

A 24-MHz external crystal is required as the frequency reference for the radio. This signal is doubled internally to create a 48-MHz clock.

The 32.768-kHz crystal is optional. The low-speed crystal oscillator is designed for use with a 32.768-kHz watch-type crystal.

The internal high-speed RC oscillator (48-MHz) can be used as a clock source for the CPU subsystem.

The internal low-speed RC oscillator (32-kHz) can be used as a reference if the low-power crystal oscillator is not used.

The 32-kHz clock source can be used as external clocking reference through GPIO.

6.9 General Peripherals and Modules

The I/O controller controls the digital I/O pins and contains multiplexer circuitry to assign a set of peripherals to I/O pins in a flexible manner. All digital I/Os are interrupt and wake-up capable, have a programmable pullup and pulldown function, and can generate an interrupt on a negative or positive edge (configurable). When configured as an output, pins can function as either push-pull or open-drain. Five GPIOs have high-drive capabilities, which are marked in **bold** in [Section 4](#).

The SSIs are synchronous serial interfaces that are compatible with SPI, MICROWIRE, and TI's synchronous serial interfaces. The SSIs support both SPI master and slave up to 4 MHz.

The UART implements a universal asynchronous receiver and transmitter function. The UART supports flexible baud-rate generation up to a maximum of 3 Mbps.

Timer 0 is a general-purpose timer module (GPTM) that provides two 16-bit timers. The GPTM can be configured to operate as a single 32-bit timer, dual 16-bit timers, or as a PWM module.

Timer 1, Timer 2, and Timer 3 are also GPTMs; each timer is functionally equivalent to Timer 0.

In addition to these four timers, a separate timer in the RF core handles timing for RF protocols; the RF timer can be synchronized to the RTC.

The I2S interface is used to handle digital audio (for more information, see the [CC13x0, CC26x0 SimpleLink™ Wireless MCU Technical Reference Manual](#)).

The I²C interface is used to communicate with devices compatible with the I²C standard. The I²C interface can handle 100-kHz and 400-kHz operation, and can serve as both I²C master and I²C slave.

The TRNG module provides a true, nondeterministic noise source for the purpose of generating keys, initialization vectors (IVs), and other random number requirements. The TRNG is built on 24 ring oscillators that create unpredictable output to feed a complex nonlinear-combinatorial circuit.

The watchdog timer is used to regain control if the system fails due to a software error after an external device fails to respond as expected. The watchdog timer can generate an interrupt or a reset when a predefined time-out value is reached.

The device includes a direct memory access (μ DMA) controller. The μ DMA controller provides a way to offload data-transfer tasks from the CM3 CPU, thus allowing for more efficient use of the processor and the available bus bandwidth. The μ DMA controller can perform transfer between memory and peripherals. The μ DMA controller has dedicated channels for each supported on-chip module and can be programmed to automatically perform transfers between peripherals and memory when the peripheral is ready to transfer more data.

Some features of the μ DMA controller follow (this is not an exhaustive list):

- Highly flexible and configurable channel operation of up to 32 channels
- Transfer modes: memory-to-memory, memory-to-peripheral, peripheral-to-memory, and peripheral-to-peripheral
- Data sizes of 8, 16, and 32 bits

The AON domain contains circuitry that is always enabled, except when in shutdown mode (where the digital supply is off). This circuitry includes the following:

- The RTC can be used to wake the device from any state where it is active. The RTC contains three compare registers and one capture register. With software support, the RTC can be used for clock and calendar operation. The RTC is clocked from the 32-kHz RC oscillator or crystal. The RTC can also be compensated to tick at the correct frequency even when the internal 32-kHz RC oscillator is used instead of a crystal.
- The battery monitor and temperature sensor are accessible by software and provide a battery status indication as well as a coarse temperature measure.

6.10 Voltage Supply Domains

The CC1310 device can interface to two or three different voltage domains depending on the package type. On-chip level converters ensure correct operation as long as the signal voltage on each input/output pin is set with respect to the corresponding supply pin (VDDS, VDDS2, or VDDS3). [Table 6-3](#) lists the pin-to-VDDS mapping.

Table 6-3. Pin Function to VDDS Mapping Table

| | Package | | |
|---------------------|-------------------------------------|-----------------------------------|-----------------------------------|
| | VQFN 7 × 7 (RGZ) | VQFN 5 × 5 (RHB) | VQFN 4 × 4 (RSM) |
| VDDS ⁽¹⁾ | DIO 23–30 Reset_N | DIO 7–14 Reset_N | DIO 5–9 Reset_N |
| VDDS2 | DIO 1–11 | DIO 0–6 JTAG_TCKC JTAG_TMSC | DIO 0–4 JTAG_TCKC JTAG_TMSC |
| VDDS3 | DIO 12–22 JTAG_TCKC JTAG_TMSC | NA | NA |

(1) The VDDS_DCDC pin must always be connected to the same voltage as the VDDS pin.

6.11 System Architecture

Depending on the product configuration, the CC1310 device can function as a wireless network processor (WNP – a device running the wireless protocol stack, with the application running on a separate host MCU), or as a system-on-chip (SoC) with the application and protocol stack running on the ARM CM3 core inside the device.

In the first case, the external host MCU communicates with the device using SPI or UART. In the second case, the application must be written according to the application framework supplied with the wireless protocol stack.

7 Application, Implementation, and Layout

NOTE

Information in the following Applications section is not part of the TI component specification, and TI does not warrant its accuracy or completeness. TI's customers are responsible for determining suitability of components for their purposes. Customers should validate and test their design implementation to confirm system functionality.

7.1 Application Information

Few external components are required for the operation of the CC1310 device. Figure 7-1 shows a typical application circuit.

The board layout greatly influences the RF performance of the CC1310 device.

On the Texas Instruments CC1310EM-7XD-7793 reference design, the optimal differential impedance seen from the RF pins into the balun and filter and antenna is $44 + j15$.

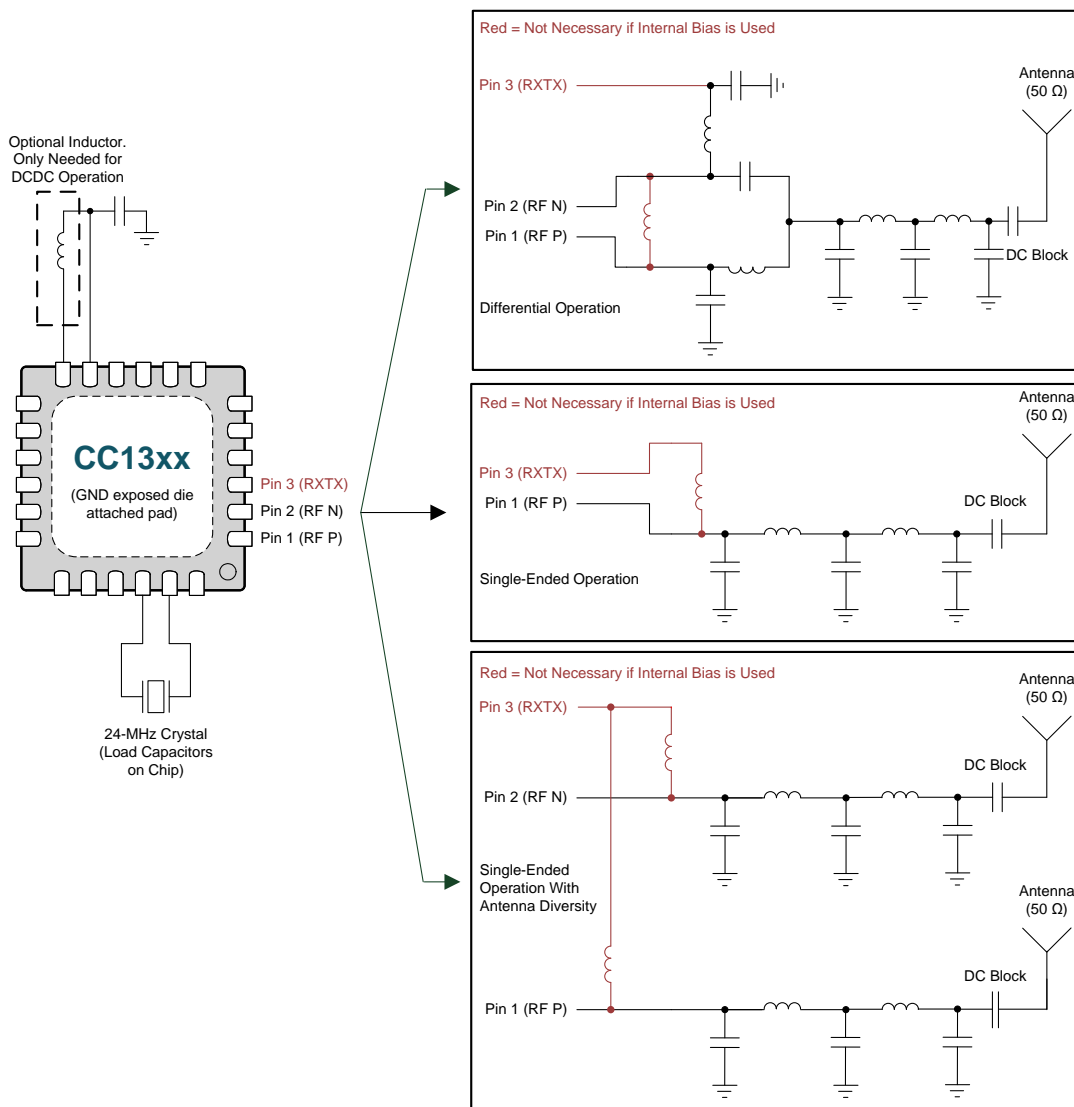

Figure 7-1 does not show decoupling capacitors for power pins. For a complete reference design, see the product folder on www.ti.com.

Figure 7-1. CC1310 Application Circuits

7.2 TI Design or Reference Design

The [TI Designs Reference Design Library](#) is a robust reference design library spanning analog, embedded processor, and connectivity. Created by TI experts to help you jumpstart your system design, all TI Designs include schematic or block diagrams, BOMs, and design files to speed your time to market.

[Humidity and Temperature Sensor Node for Sub-1 GHz Star Networks Enabling 10+ Year Coin Cell Battery Life](#)

This reference design uses TI's nano-power system timer, boost converter, SimpleLink™ ultra-low-power Sub-1GHz wireless MCU platform, and humidity-sensing technologies to demonstrate an ultra-low-power method to duty-cycle sensor end nodes leading to extremely long battery life. The TI Design includes techniques for system design, detailed test results, and information to get the design operating running quickly.

[SimpleLink™ Sub-1 GHz Sensor to Cloud Gateway Reference Design for TI-RTOS Systems](#)

This reference design demonstrates how to connect sensors to the cloud over a long-range Sub-1 GHz wireless network, suitable for industrial settings such as building control and asset tracking. The solution is based on a TI-RTOS gateway. This design provides a complete end-to-end solution for creating a Sub-1 GHz sensor network with an Internet of Things (IoT) gateway solution and cloud connectivity. The gateway solution is based on the low-power, SimpleLink™ Wi-Fi® CC3220 wireless microcontroller (MCU), which hosts the gateway application and the SimpleLink Sub-1 GHz CC1310/CC1312R or the multi-band CC1350/ CC1352R wireless MCU as the MAC Co-Processor. The reference design also includes sensor node example applications running on the SimpleLink Sub-1 GHz CC1312R/CC1310 and multi-band CC1352R/CC1350 wireless MCUs.

[Low-Power Wireless M-Bus Communications Module Reference Design](#)

This reference design explains how to use the TI wireless M-Bus stack for CC1310 and CC1350 wireless MCUs and integrate it into a smart meter or data-collector product. This software stack is compatible with the Open Metering System (OMS) v3.0.1 specification. This design offers ready-to-use binary images for any of the wireless M-Bus S-, T-, or C-modes at 868 MHz with unidirectional (meter) or bidirectional configurations (both meter and data collector).

[Low-Power Water Flow Measurement With Inductive Sensing Reference Design](#)

This reference design demonstrates a highly-integrated solution for this application using an inductive sensing technique enabled by the CC1310/CC1350 SimpleLink™ Wireless MCU and FemtoFET™ MOSFET. This reference design also provides the platform for integration of wireless communications such as wireless M-Bus, Sigfox™, or a proprietary protocol.

[Heat Cost Allocator with wM-Bus at 868 MHz Reference Design](#)

This reference design implements a heat cost allocator system following the EN834 standard with the 'two-sensor measurement method'. The solution achieves better than 0.5 degrees Celsius accuracy across a range of +20 to +85°C. Two analog temperature sensors are available as matched pairs to eliminate the need for calibration during manufacturing and lowering OEM system cost. The CC1310 wireless MCU provides a single-chip solution for heat measurement (control of the two temperature sensors) and RF communications (example code using 868 MHz wM-Bus S, T and C-modes "Meter" device).

[Sub-1 GHz Sensor to Cloud Industrial IoT Gateway Reference Design for Linux Systems](#)

This reference design demonstrates how to connect sensors to the cloud over a long-range Sub-1 GHz wireless network, suitable for industrial settings such as building control and asset tracking. This design provides a complete end-to-end solution for creating a Sub-1 GHz sensor network with an Internet of Things (IoT) gateway solution and cloud connectivity. The gateway solution is based on the low-power, SimpleLink™ Wi-Fi® CC3220 wireless microcontroller (MCU), which hosts the gateway application and the SimpleLink Sub-1 GHz CC1312R/CC1310 or the multi-band CC1352R/CC1350 wireless MCU as the MAC Co-Processor.

8 Device and Documentation Support

TI offers an extensive line of development tools. Tools and software to evaluate the performance of the device, generate code, and develop solutions are listed in the following.

8.1 Device Nomenclature

To designate the stages in the product development cycle, TI assigns prefixes to all part numbers and/or date-code. Each device has one of three prefixes/identifications: X, P, or null (no prefix) (for example, CC1310 is in production; therefore, no prefix/identification is assigned).

Device development evolutionary flow:

- X** Experimental device that is not necessarily representative of the final device's electrical specifications and may not use production assembly flow.
- P** Prototype device that is not necessarily the final silicon die and may not necessarily meet final electrical specifications.
- null** Production version of the silicon die that is fully qualified.

Production devices have been characterized fully, and the quality and reliability of the device have been demonstrated fully. TI's standard warranty applies.

Predictions show that prototype devices (X or P) have a greater failure rate than the standard production devices. Texas Instruments recommends that these devices not be used in any production system because their expected end-use failure rate still is undefined. Only qualified production devices are to be used.

TI device nomenclature also includes a suffix with the device family name. This suffix indicates the package type (for example, RGZ).

For orderable part numbers of CC1310 devices in the RSM (4-mm x 4-mm), RHB (5-mm x 5-mm), or RGZ (7-mm x 7-mm) package types, see the *Package Option Addendum* of this document, the TI website (www.ti.com), or contact your TI sales representative.

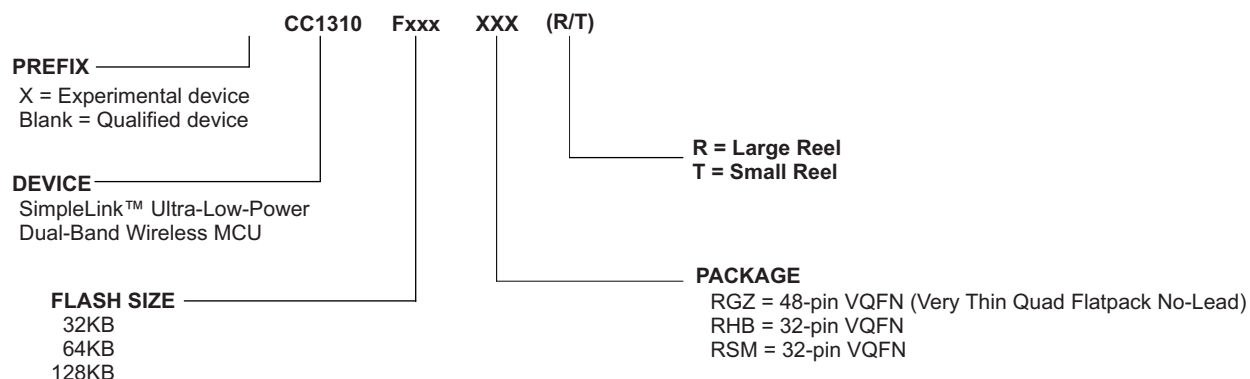

Figure 8-1. Device Nomenclature

8.2 Tools and Software

Development Kit:

SimpleLink™ Sub-1 GHz CC1310 Wireless MCU LaunchPad™ Development Kit

The SimpleLink™ Sub-1 GHz CC1310 wireless microcontroller (MCU) LaunchPad™ development kit is the first LaunchPad kit with a Sub-1 GHz radio, which offers long-range connectivity, combined with a 32-bit Arm® Cortex®-M3 processor on a single chip.

The CC1310 device is a wireless MCU targeting low-power, long-range wireless applications. The CC1310 wireless MCU contains a 32-bit Arm Cortex-M3 processor that runs at 48 MHz as the main processor and a rich peripheral feature set that includes a unique ultra-low power sensor controller. This sensor controller is great for interfacing external sensors and for collecting analog and digital data autonomously while the rest of the system is in sleep mode.

Software:

SimpleLink™ CC13x0 SDK

The SimpleLink™ Sub-1 GHz CC13x0 software development kit (SDK) provides a comprehensive Sub-1 GHz software package for the Sub-1 GHz CC1310 and Dual-band CC1350 wireless MCUs and includes the following:

- TI 15.4-Stack - IEEE 802.15.4e/g-based star topology networking solution for Sub-1 GHz ISM bands (433 MHz, 868 MHz and 915 MHz).
- Support for proprietary solutions - proprietary RF examples for Sub-1 GHz based on the RF driver and EasyLink Abstraction Layer.
- Bluetooth Low Energy – Stack including support for all Bluetooth core specification 4.2 features as well as a BLE micro-stack to support customers using the Dual-Band CC1350 wireless MCU.

The SimpleLink CC13x0 SDK is part of the TI SimpleLink MCU platform, offering a single development environment that delivers flexible hardware, software and tool options for customers developing wired and wireless applications. For more information about the SimpleLink MCU Platform, visit www.ti.com/simplelink.

Software Tools:

SmartRF™ Studio 7

SmartRF™ Studio is a PC application that helps designers of radio systems to easily evaluate the RF-IC at an early stage in the design process.

- Test functions for transmitting and receiving radio packets, continuous wave transmit and receive
- Evaluate RF performance on custom boards by wiring it to a supported evaluation board or debugger
- Can also be used without any hardware, but then only to generate, edit and export radio configuration settings
- Can be used in combination with several development kits for Texas Instruments' CC1310 RF-ICs

Sensor Controller Studio

Sensor Controller Studio provides a development environment for the CC1310 Sensor Controller. The Sensor Controller is a proprietary, power-optimized CPU inside the CC1310, which can perform simple background tasks autonomously and independent of the System CPU state.

- Allows for Sensor Controller task algorithms to be implemented using a C-like programming language
- Outputs a Sensor Controller Interface driver, which incorporates the generated Sensor Controller machine code and associated definitions
- Allows for rapid development by using the integrated Sensor Controller task testing and debugging functionality. This allows for live visualization of sensor data and algorithm verification.

IDEs and Compilers:

Code Composer Studio™ IDE

- An integrated development environment (IDE) with project management tools and editor
- Code Composer Studio (CCS) 6.1 and later has built-in support for the CC1310 device family
- Best support for XDS debuggers; XDS100v3, XDS110 and XDS200
- High integration with TI-RTOS with support for TI-RTOS Object View

Code Composer Studio™ Cloud IDE

Code Composer Studio™ (CCS) Cloud is a web-based IDE that allows you to create, edit, and build CCS and Energia projects. After you have successfully built your project, you can download and run on your connected LaunchPad™ development kit. Basic debugging, including features like setting breakpoints and viewing variable values is now supported with CCS Cloud.

CCS UniFlash

CCS UniFlash is a standalone tool used to program on-chip flash memory on TI MCUs. UniFlash has a GUI, command line, and scripting interface. CCS UniFlash is available free of charge.

IAR Embedded Workbench® for Arm

- Integrated development environment with project management tools and editor
- IAR EWARM 7.30.3 and later has built-in support for the CC1310 device family
- Broad debugger support, supporting XDS100v3, XDS200, IAR I-jet® and SEGGER J-Link™
- Integrated development environment with project management tools and editor
- RTOS plugin available for [TI-RTOS](#)

For a complete listing of development-support tools for the CC1310 platform, visit the Texas Instruments website at www.ti.com. For information on pricing and availability, contact the nearest TI field sales office or authorized distributor.

8.3 Documentation Support

To receive notification of documentation updates, navigate to the device product folder on ti.com (**CC1310**). In the upper right corner, click on Alert me to register and receive a weekly digest of any product information that has changed. For change details, review the revision history included in any revised document.

The current documentation that describes the CC1310, related peripherals, and other technical collateral is listed in the following.

Errata

[CC1310 SimpleLink™ Ultra-Low-Power Sub-1 GHz Wireless MCU Silicon Revisions B, A Silicon Errata](#)

Technical Reference Manual

[CC13xx, CC26xx SimpleLink™ Wireless MCU Technical Reference Manual](#)

Reference Guide

[CC26xx/CC13xx Power Management Software Developer's Reference Guide](#)

8.4 Texas Instruments Low-Power RF Website

TI's Low-Power RF website has all the latest products, application and design notes, FAQ section, news and events updates. Go to www.ti.com/longrange.

8.5 Additional Information

Texas Instruments offers a wide selection of cost-effective, low-power RF solutions for proprietary and standard-based wireless applications for use in industrial and consumer applications. The selection includes RF transceivers, RF transmitters, RF front ends, and Systems-on-Chips as well as various software solutions for the Sub-1 GHz and 2.4-GHz frequency bands.

In addition, Texas Instruments provides a large selection of support collateral such as development tools, technical documentation, reference designs, application expertise, customer support, third-party and university programs.

Other than providing technical support forums, videos, and blogs, the Low-Power RF E2E Online Community also presents the opportunity to interact with engineers from all over the world.

With a broad selection of product solutions, end-application possibilities, and a range of technical support, Texas Instruments offers the broadest low-power RF portfolio.

8.6 Community Resources

The following links connect to TI community resources. Linked contents are provided "AS IS" by the respective contributors. They do not constitute TI specifications and do not necessarily reflect TI's views; see TI's [Terms of Use](#).

TI E2E™ Online Community The TI engineer-to-engineer (E2E) community was created to foster collaboration among engineers. At e2e.ti.com, you can ask questions, share knowledge, explore ideas and help solve problems with fellow engineers.

TI Embedded Processors Wiki *Texas Instruments Embedded Processors Wiki*. Established to help developers get started with Embedded Processors from Texas Instruments and to foster innovation and growth of general knowledge about the hardware and software surrounding these devices.

8.7 Trademarks

SimpleLink, SmartRF, Code Composer Studio, Texas Instruments, FemtoFET, E2E are trademarks of Texas Instruments.

ARM7 is a trademark of ARM Limited (or its subsidiaries).

Arm, Cortex, Thumb are registered trademarks of Arm Limited (or its subsidiaries).

Bluetooth is a registered trademark of Bluetooth SIG, Inc.

ULPBench is a trademark of Embedded Microprocessor Benchmark Consortium.

CoreMark is a registered trademark of Embedded Microprocessor Benchmark Consortium.

IAR Embedded Workbench, I-jet are registered trademarks of IAR Systems AB.

IEEE Std 1241 is a trademark of Institute of Electrical and Electronics Engineers, Incorporated.

IEEE is a registered trademark of Institute of Electrical and Electronics Engineers, Incorporated.

J-Link is a trademark of SEGGER Microcontroller GmbH.

Wi-Fi is a registered trademark of Wi-Fi Alliance.

Wi-SUN is a trademark of Wi-SUN Alliance, Inc.

Zigbee is a registered trademark of Zigbee Alliance.

All other trademarks are the property of their respective owners.

8.8 Electrostatic Discharge Caution



This integrated circuit can be damaged by ESD. Texas Instruments recommends that all integrated circuits be handled with appropriate precautions. Failure to observe proper handling and installation procedures can cause damage.

ESD damage can range from subtle performance degradation to complete device failure. Precision integrated circuits may be more susceptible to damage because very small parametric changes could cause the device not to meet its published specifications.

8.9 Export Control Notice

Recipient agrees to not knowingly export or re-export, directly or indirectly, any product or technical data (as defined by the U.S., EU, and other Export Administration Regulations) including software, or any controlled product restricted by other applicable national regulations, received from disclosing party under nondisclosure obligations (if any), or any direct product of such technology, to any destination to which such export or re-export is restricted or prohibited by U.S. or other applicable laws, without obtaining prior authorization from U.S. Department of Commerce and other competent Government authorities to the extent required by those laws.

8.10 Glossary

[TI Glossary](#) This glossary lists and explains terms, acronyms, and definitions.

9 Mechanical, Packaging, and Orderable Information

9.1 Packaging Information

The following pages include mechanical packaging and orderable information. This information is the most current data available for the designated devices. This data is subject to change without notice and revision of this document. For browser-based versions of this data sheet, refer to the left-hand navigation.

PACKAGING INFORMATION

| Orderable Device | Status (1) | Package Type | Package Drawing | Pins | Package Qty | Eco Plan (2) | Lead finish/ Ball material (6) | MSL Peak Temp (3) | Op Temp (°C) | Device Marking (4/5) | Samples |
|------------------|---------------|--------------|-----------------|------|-------------|-----------------|--------------------------------------|----------------------|--------------|-------------------------|-------------------------|
| CC1310F128RGZR | ACTIVE | VQFN | RGZ | 48 | 2500 | RoHS & Green | NIPDAU NIPDAUAG | Level-3-260C-168 HR | -40 to 85 | CC1310 F128 | Samples |
| CC1310F128RGZT | ACTIVE | VQFN | RGZ | 48 | 250 | RoHS & Green | NIPDAU NIPDAUAG | Level-3-260C-168 HR | -40 to 85 | CC1310 F128 | Samples |
| CC1310F128RHBR | ACTIVE | VQFN | RHB | 32 | 3000 | RoHS & Green | NIPDAU NIPDAUAG | Level-3-260C-168 HR | -40 to 85 | CC1310 F128 | Samples |
| CC1310F128RHBT | ACTIVE | VQFN | RHB | 32 | 250 | RoHS & Green | NIPDAU NIPDAUAG | Level-3-260C-168 HR | -40 to 85 | CC1310 F128 | Samples |
| CC1310F128RSMR | ACTIVE | VQFN | RSM | 32 | 3000 | RoHS & Green | NIPDAU NIPDAUAG | Level-3-260C-168 HR | -40 to 85 | CC1310 F128 | Samples |
| CC1310F128RSMT | ACTIVE | VQFN | RSM | 32 | 250 | RoHS & Green | NIPDAU NIPDAUAG | Level-3-260C-168 HR | -40 to 85 | CC1310 F128 | Samples |
| CC1310F32RGZR | ACTIVE | VQFN | RGZ | 48 | 2500 | RoHS & Green | NIPDAU NIPDAUAG | Level-3-260C-168 HR | -40 to 85 | CC1310 F32 | Samples |
| CC1310F32RGZT | ACTIVE | VQFN | RGZ | 48 | 250 | RoHS & Green | NIPDAU NIPDAUAG | Level-3-260C-168 HR | -40 to 85 | CC1310 F32 | Samples |
| CC1310F32RHBR | ACTIVE | VQFN | RHB | 32 | 3000 | RoHS & Green | NIPDAU NIPDAUAG | Level-3-260C-168 HR | -40 to 85 | CC1310 F32 | Samples |
| CC1310F32RHBT | ACTIVE | VQFN | RHB | 32 | 250 | RoHS & Green | NIPDAU NIPDAUAG | Level-3-260C-168 HR | -40 to 85 | CC1310 F32 | Samples |
| CC1310F32RSMR | ACTIVE | VQFN | RSM | 32 | 3000 | RoHS & Green | NIPDAU NIPDAUAG | Level-3-260C-168 HR | -40 to 85 | CC1310 F32 | Samples |
| CC1310F32RSMT | ACTIVE | VQFN | RSM | 32 | 250 | RoHS & Green | NIPDAU NIPDAUAG | Level-3-260C-168 HR | -40 to 85 | CC1310 F32 | Samples |
| CC1310F64RGZR | ACTIVE | VQFN | RGZ | 48 | 2500 | RoHS & Green | NIPDAU NIPDAUAG | Level-3-260C-168 HR | -40 to 85 | CC1310 F64 | Samples |
| CC1310F64RGZT | ACTIVE | VQFN | RGZ | 48 | 250 | RoHS & Green | NIPDAU NIPDAUAG | Level-3-260C-168 HR | -40 to 85 | CC1310 F64 | Samples |
| CC1310F64RHBR | ACTIVE | VQFN | RHB | 32 | 3000 | RoHS & Green | NIPDAU NIPDAUAG | Level-3-260C-168 HR | -40 to 85 | CC1310 F64 | Samples |
| CC1310F64RHBT | ACTIVE | VQFN | RHB | 32 | 250 | RoHS & Green | NIPDAU NIPDAUAG | Level-3-260C-168 HR | -40 to 85 | CC1310 F64 | Samples |
| CC1310F64RSMR | ACTIVE | VQFN | RSM | 32 | 3000 | RoHS & Green | NIPDAU NIPDAUAG | Level-3-260C-168 HR | -40 to 85 | CC1310 | Samples |

| Orderable Device | Status (1) | Package Type | Package Drawing | Pins | Package Qty | Eco Plan (2) | Lead finish/ Ball material (6) | MSL Peak Temp (3) | Op Temp (°C) | Device Marking (4/5) | Samples |
|------------------|---------------|--------------|-----------------|------|-------------|-----------------|--------------------------------------|----------------------|--------------|-------------------------|-------------------------|
| CC1310F64RSMT | ACTIVE | VQFN | RSM | 32 | 250 | RoHS & Green | NIPDAU NIPDAUAG | Level-3-260C-168 HR | -40 to 85 | F64 CC1310 F64 | Samples |

(1) The marketing status values are defined as follows:

ACTIVE: Product device recommended for new designs.

LIFEBUY: TI has announced that the device will be discontinued, and a lifetime-buy period is in effect.

NRND: Not recommended for new designs. Device is in production to support existing customers, but TI does not recommend using this part in a new design.

PREVIEW: Device has been announced but is not in production. Samples may or may not be available.

OBSOLETE: TI has discontinued the production of the device.

(2) **RoHS:** TI defines "RoHS" to mean semiconductor products that are compliant with the current EU RoHS requirements for all 10 RoHS substances, including the requirement that RoHS substance do not exceed 0.1% by weight in homogeneous materials. Where designed to be soldered at high temperatures, "RoHS" products are suitable for use in specified lead-free processes. TI may reference these types of products as "Pb-Free".

RoHS Exempt: TI defines "RoHS Exempt" to mean products that contain lead but are compliant with EU RoHS pursuant to a specific EU RoHS exemption.

Green: TI defines "Green" to mean the content of Chlorine (Cl) and Bromine (Br) based flame retardants meet JS709B low halogen requirements of <=100ppm threshold. Antimony trioxide based flame retardants must also meet the <=1000ppm threshold requirement.

(3) MSL, Peak Temp. - The Moisture Sensitivity Level rating according to the JEDEC industry standard classifications, and peak solder temperature.

(4) There may be additional marking, which relates to the logo, the lot trace code information, or the environmental category on the device.

(5) Multiple Device Markings will be inside parentheses. Only one Device Marking contained in parentheses and separated by a "-" will appear on a device. If a line is indented then it is a continuation of the previous line and the two combined represent the entire Device Marking for that device.

(6) Lead finish/Ball material - Orderable Devices may have multiple material finish options. Finish options are separated by a vertical ruled line. Lead finish/Ball material values may wrap to two lines if the finish value exceeds the maximum column width.

Important Information and Disclaimer:The information provided on this page represents TI's knowledge and belief as of the date that it is provided. TI bases its knowledge and belief on information provided by third parties, and makes no representation or warranty as to the accuracy of such information. Efforts are underway to better integrate information from third parties. TI has taken and continues to take reasonable steps to provide representative and accurate information but may not have conducted destructive testing or chemical analysis on incoming materials and chemicals. TI and TI suppliers consider certain information to be proprietary, and thus CAS numbers and other limited information may not be available for release.

In no event shall TI's liability arising out of such information exceed the total purchase price of the TI part(s) at issue in this document sold by TI to Customer on an annual basis.

TAPE AND REEL INFORMATION

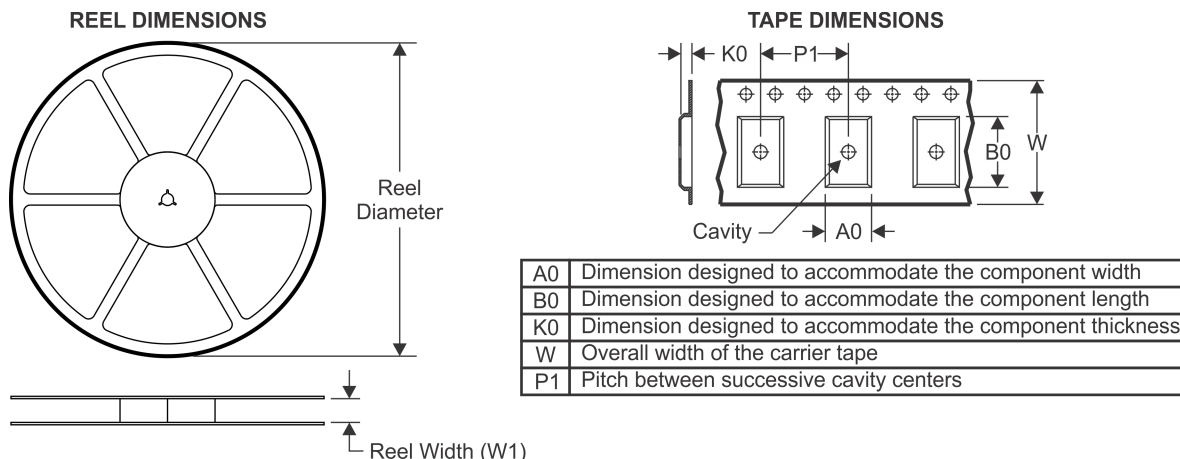

QUADRANT ASSIGNMENTS FOR PIN 1 ORIENTATION IN TAPE



*All dimensions are nominal

| Device | Package Type | Package Drawing | Pins | SPQ | Reel Diameter (mm) | Reel Width W1 (mm) | A0 (mm) | B0 (mm) | K0 (mm) | P1 (mm) | W (mm) | Pin1 Quadrant |
|----------------|--------------|-----------------|------|------|--------------------|--------------------|---------|---------|---------|---------|--------|---------------|
| CC1310F128RGZR | VQFN | RGZ | 48 | 2500 | 330.0 | 16.4 | 7.3 | 7.3 | 1.1 | 12.0 | 16.0 | Q2 |
| CC1310F128RGZT | VQFN | RGZ | 48 | 250 | 180.0 | 16.4 | 7.3 | 7.3 | 1.1 | 12.0 | 16.0 | Q2 |
| CC1310F128RHBR | VQFN | RHB | 32 | 3000 | 330.0 | 12.4 | 5.3 | 5.3 | 1.1 | 8.0 | 12.0 | Q2 |
| CC1310F128RHBR | VQFN | RHB | 32 | 3000 | 330.0 | 12.4 | 5.3 | 5.3 | 1.1 | 8.0 | 12.0 | Q2 |
| CC1310F128RHBT | VQFN | RHB | 32 | 250 | 180.0 | 12.4 | 5.3 | 5.3 | 1.1 | 8.0 | 12.0 | Q2 |
| CC1310F128RHBT | VQFN | RHB | 32 | 250 | 180.0 | 12.4 | 5.3 | 5.3 | 1.1 | 8.0 | 12.0 | Q2 |
| CC1310F128RSMR | VQFN | RSM | 32 | 3000 | 330.0 | 12.4 | 4.25 | 4.25 | 1.15 | 8.0 | 12.0 | Q2 |
| CC1310F128RSMT | VQFN | RSM | 32 | 250 | 180.0 | 12.4 | 4.25 | 4.25 | 1.15 | 8.0 | 12.0 | Q2 |
| CC1310F32RHBR | VQFN | RHB | 32 | 3000 | 330.0 | 12.4 | 5.3 | 5.3 | 1.1 | 8.0 | 12.0 | Q2 |
| CC1310F32RHBT | VQFN | RHB | 32 | 250 | 180.0 | 12.4 | 5.3 | 5.3 | 1.1 | 8.0 | 12.0 | Q2 |
| CC1310F32RSMT | VQFN | RSM | 32 | 250 | 180.0 | 12.4 | 4.25 | 4.25 | 1.15 | 8.0 | 12.0 | Q2 |
| CC1310F64RHBR | VQFN | RHB | 32 | 3000 | 330.0 | 12.4 | 5.3 | 5.3 | 1.1 | 8.0 | 12.0 | Q2 |
| CC1310F64RHBT | VQFN | RHB | 32 | 250 | 180.0 | 12.4 | 5.3 | 5.3 | 1.1 | 8.0 | 12.0 | Q2 |
| CC1310F64RSMR | VQFN | RSM | 32 | 3000 | 330.0 | 12.4 | 4.25 | 4.25 | 1.15 | 8.0 | 12.0 | Q2 |
| CC1310F64RSMT | VQFN | RSM | 32 | 250 | 180.0 | 12.4 | 4.25 | 4.25 | 1.15 | 8.0 | 12.0 | Q2 |

TAPE AND REEL BOX DIMENSIONS

*All dimensions are nominal

| Device | Package Type | Package Drawing | Pins | SPQ | Length (mm) | Width (mm) | Height (mm) |
|----------------|--------------|-----------------|------|------|-------------|------------|-------------|
| CC1310F128RGZR | VQFN | RGZ | 48 | 2500 | 367.0 | 367.0 | 35.0 |
| CC1310F128RGZT | VQFN | RGZ | 48 | 250 | 210.0 | 185.0 | 35.0 |
| CC1310F128RHBR | VQFN | RHB | 32 | 3000 | 367.0 | 367.0 | 35.0 |
| CC1310F128RHBR | VQFN | RHB | 32 | 3000 | 336.6 | 336.6 | 31.8 |
| CC1310F128RHBT | VQFN | RHB | 32 | 250 | 210.0 | 185.0 | 35.0 |
| CC1310F128RHBT | VQFN | RHB | 32 | 250 | 210.0 | 185.0 | 35.0 |
| CC1310F128RSMR | VQFN | RSM | 32 | 3000 | 367.0 | 367.0 | 35.0 |
| CC1310F128RSMT | VQFN | RSM | 32 | 250 | 210.0 | 185.0 | 35.0 |
| CC1310F32RHBR | VQFN | RHB | 32 | 3000 | 367.0 | 367.0 | 35.0 |
| CC1310F32RHBT | VQFN | RHB | 32 | 250 | 210.0 | 185.0 | 35.0 |
| CC1310F32RSMT | VQFN | RSM | 32 | 250 | 210.0 | 185.0 | 35.0 |
| CC1310F64RHBR | VQFN | RHB | 32 | 3000 | 367.0 | 367.0 | 35.0 |
| CC1310F64RHBT | VQFN | RHB | 32 | 250 | 210.0 | 185.0 | 35.0 |
| CC1310F64RSMR | VQFN | RSM | 32 | 3000 | 367.0 | 367.0 | 35.0 |
| CC1310F64RSMT | VQFN | RSM | 32 | 250 | 210.0 | 185.0 | 35.0 |

GENERIC PACKAGE VIEW

RHB 32

VQFN - 1 mm max height

5 x 5, 0.5 mm pitch

PLASTIC QUAD FLATPACK - NO LEAD

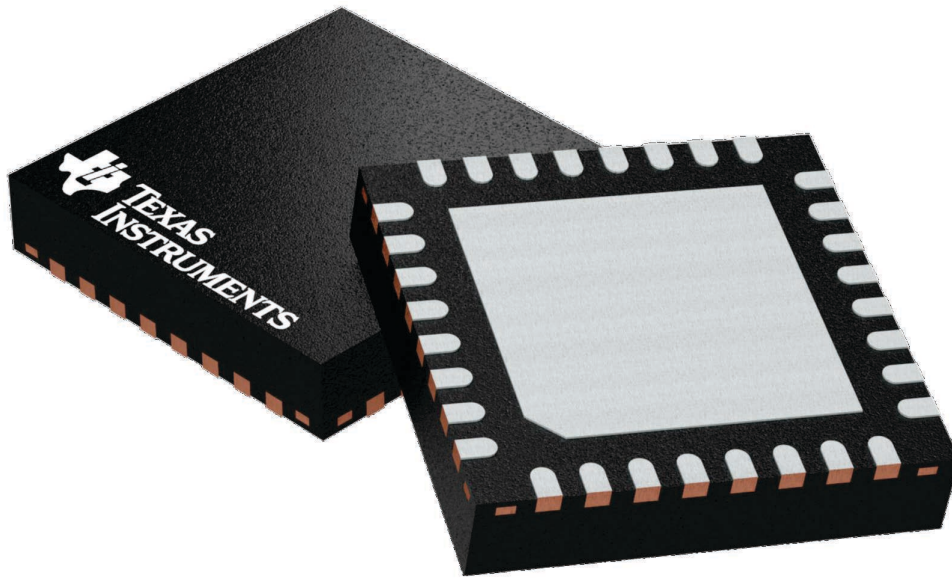

Images above are just a representation of the package family, actual package may vary.
Refer to the product data sheet for package details.

4224745/A

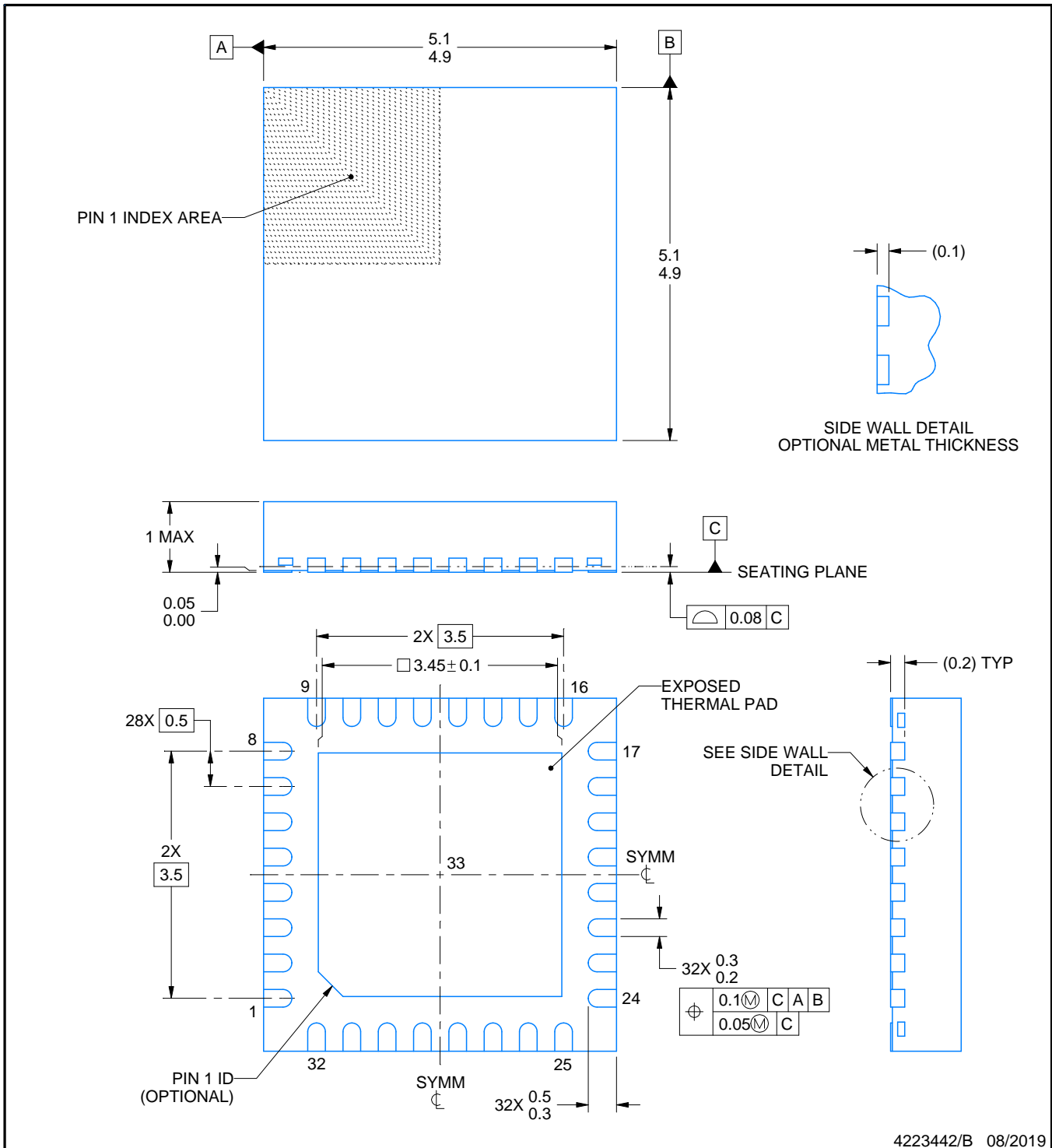

4223442/B 08/2019

NOTES:

1. All linear dimensions are in millimeters. Any dimensions in parenthesis are for reference only. Dimensioning and tolerancing per ASME Y14.5M.
2. This drawing is subject to change without notice.
3. The package thermal pad must be soldered to the printed circuit board for thermal and mechanical performance.

EXAMPLE BOARD LAYOUT

RHB0032E

VQFN - 1 mm max height

PLASTIC QUAD FLATPACK - NO LEAD



LAND PATTERN EXAMPLE
SCALE:18X

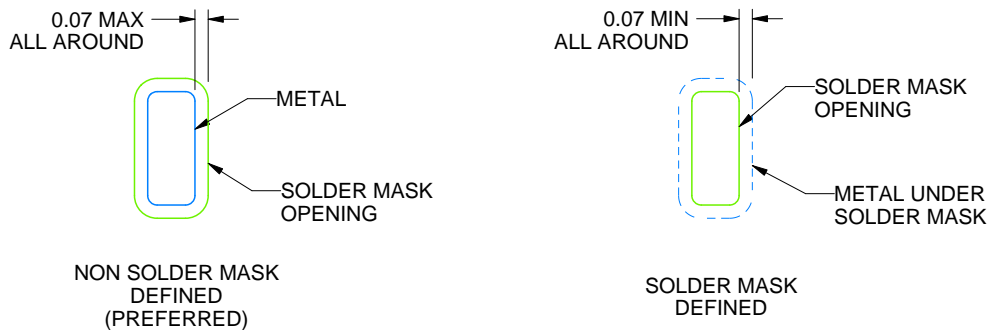

SOLDER MASK DETAILS

4223442/B 08/2019

NOTES: (continued)

4. This package is designed to be soldered to a thermal pad on the board. For more information, see Texas Instruments literature number SLUA271 (www.ti.com/lit/sluea271).
5. Vias are optional depending on application, refer to device data sheet. If any vias are implemented, refer to their locations shown on this view. It is recommended that vias under paste be filled, plugged or tented.

EXAMPLE STENCIL DESIGN

RHB0032E

VQFN - 1 mm max height

PLASTIC QUAD FLATPACK - NO LEAD

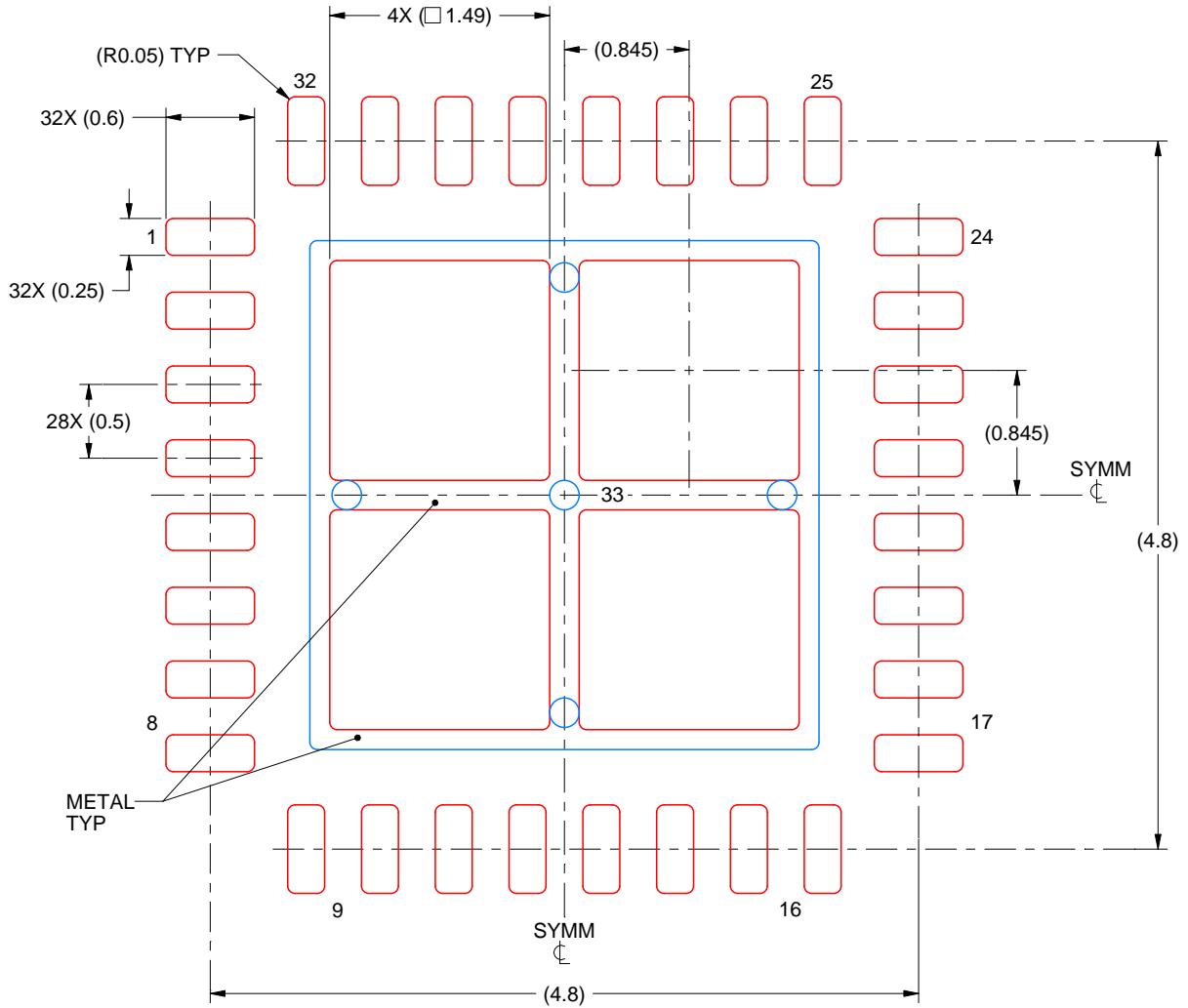

SOLDER PASTE EXAMPLE
 BASED ON 0.125 mm THICK STENCIL

EXPOSED PAD 33:
 75% PRINTED SOLDER COVERAGE BY AREA UNDER PACKAGE
 SCALE:20X

4223442/B 08/2019

NOTES: (continued)

6. Laser cutting apertures with trapezoidal walls and rounded corners may offer better paste release. IPC-7525 may have alternate design recommendations.

GENERIC PACKAGE VIEW

RGZ 48

VQFN - 1 mm max height

7 x 7, 0.5 mm pitch

PLASTIC QUADFLAT PACK- NO LEAD

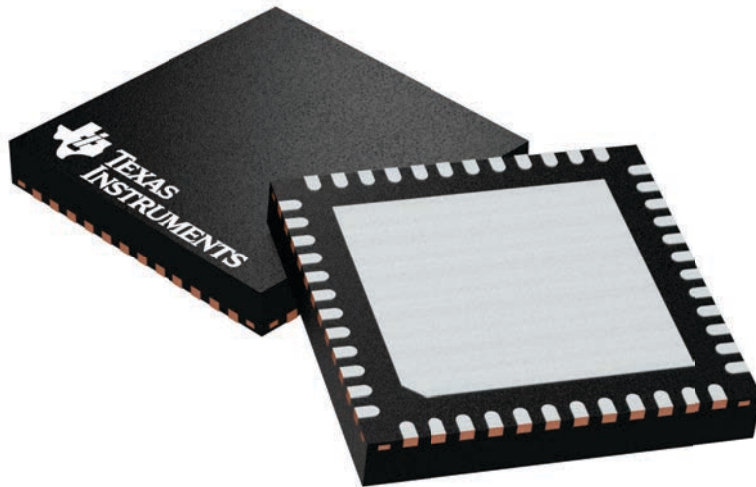

Images above are just a representation of the package family, actual package may vary.
Refer to the product data sheet for package details.

4224671/A

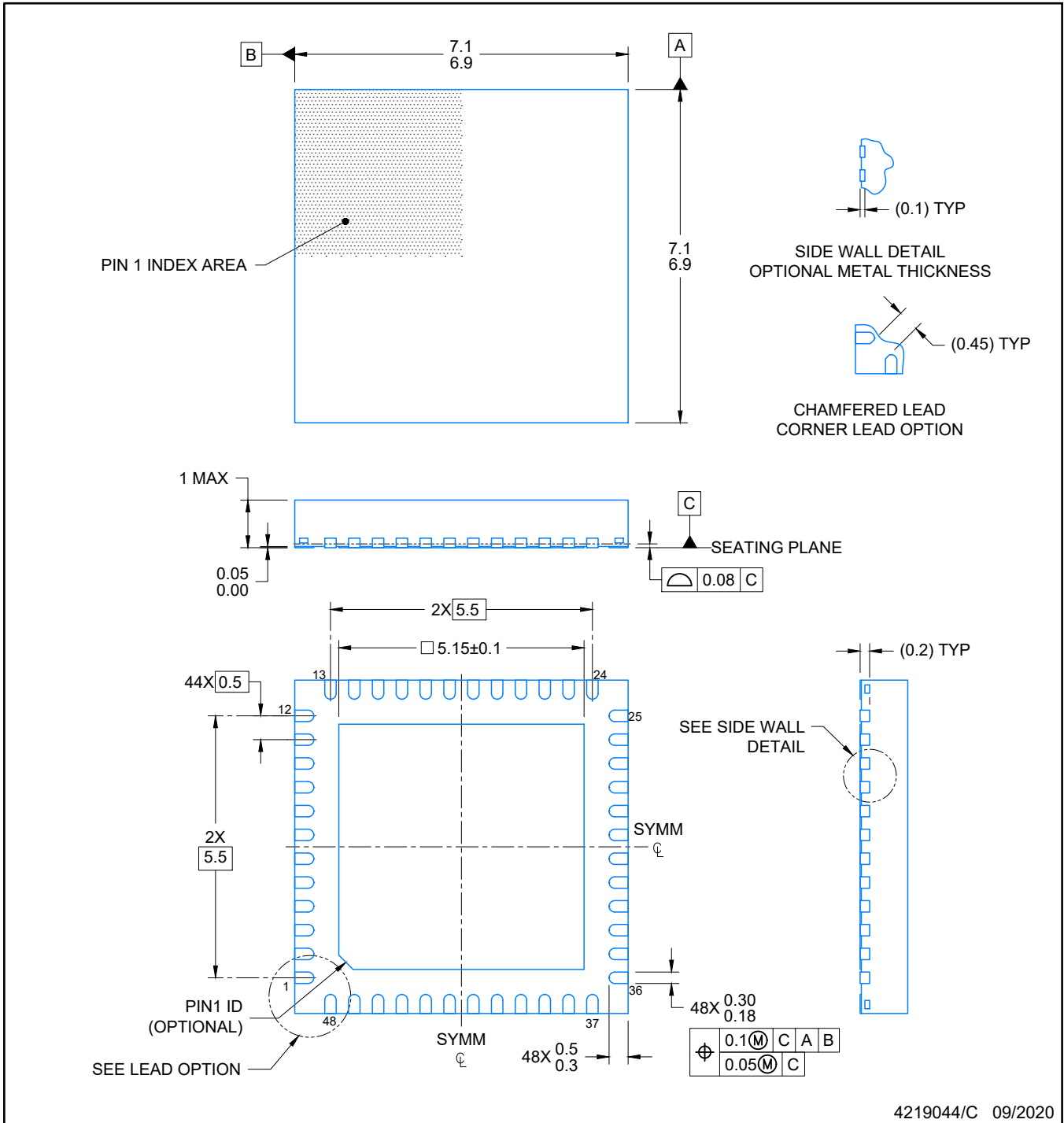

NOTES:

1. All linear dimensions are in millimeters. Any dimensions in parenthesis are for reference only. Dimensioning and tolerancing per ASME Y14.5M.
2. This drawing is subject to change without notice.
3. The package thermal pad must be soldered to the printed circuit board for optimal thermal and mechanical performance.

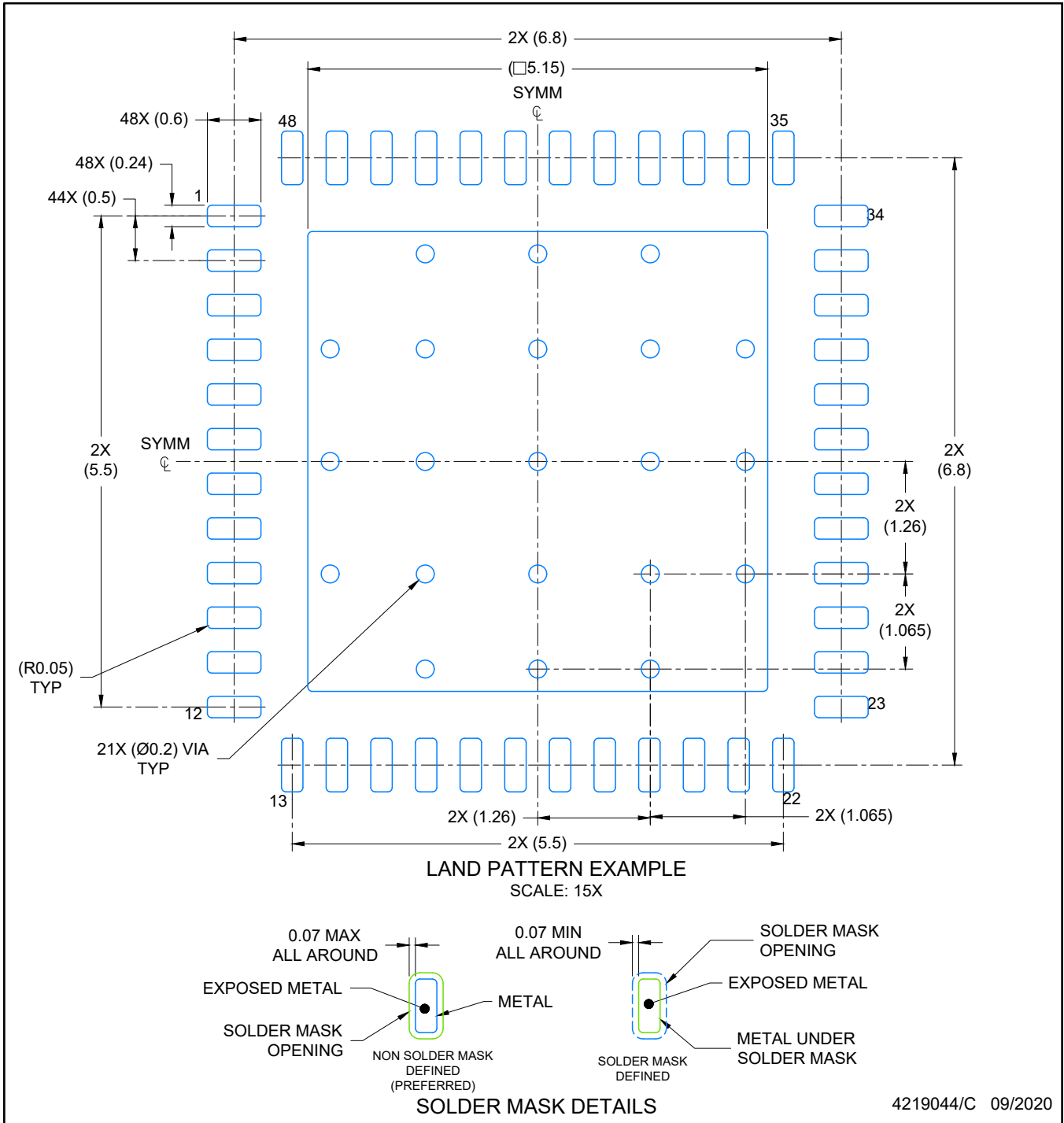

NOTES: (continued)

4. This package is designed to be soldered to a thermal pad on the board. For more information, see Texas Instruments literature number SLUA271 (www.ti.com/lit/slua271).
5. Vias are optional depending on application, refer to device data sheet. If any vias are implemented, refer to their locations shown on this view. It is recommended that vias under paste be filled, plugged or tented.

EXAMPLE STENCIL DESIGN

RGZ0048A

VQFN - 1 mm max height

PLASTIC QUADFLAT PACK- NO LEAD

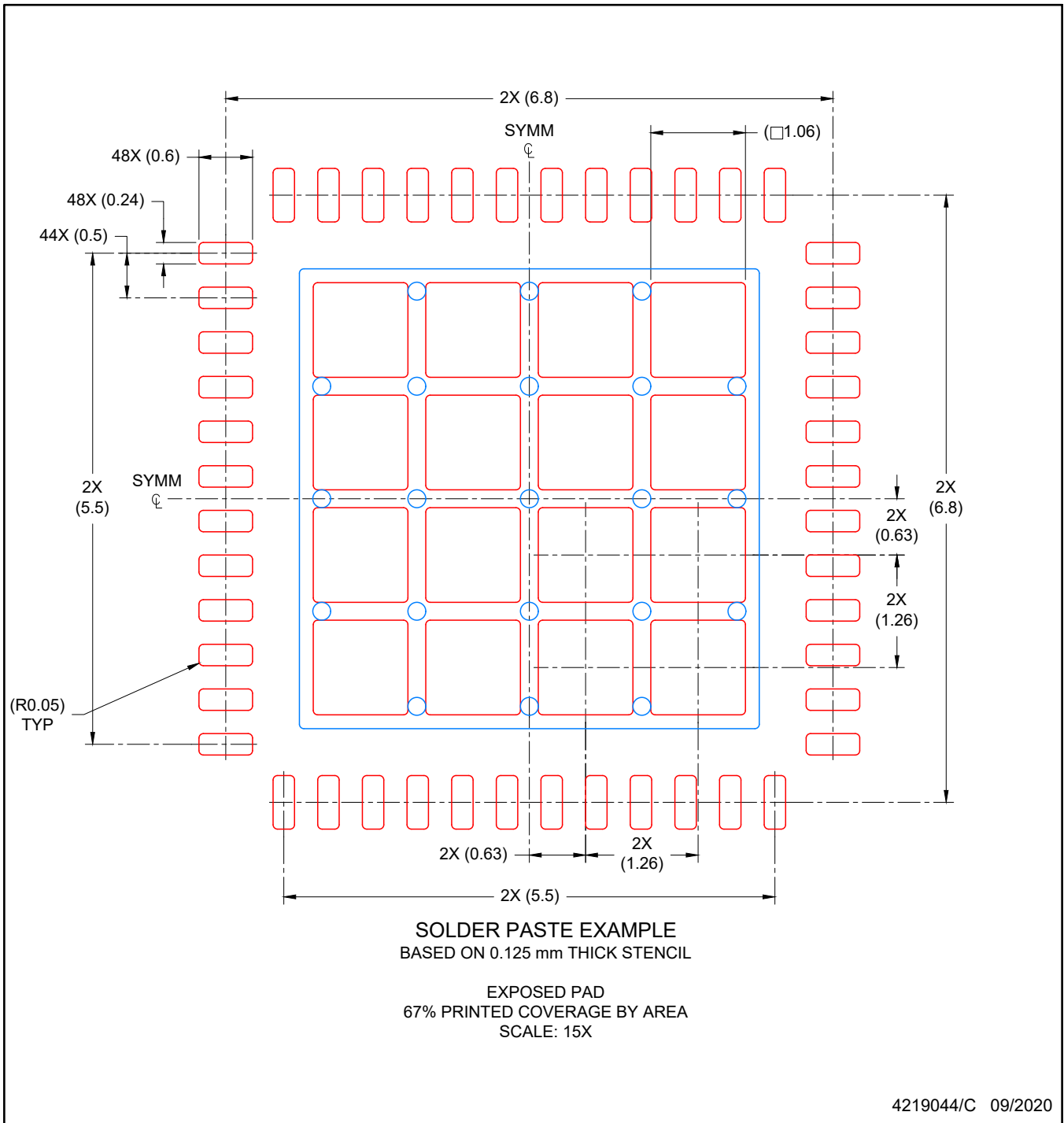

NOTES: (continued)

6. Laser cutting apertures with trapezoidal walls and rounded corners may offer better paste release. IPC-7525 may have alternate design recommendations.

GENERIC PACKAGE VIEW

RSM 32

VQFN - 1 mm max height

4 x 4, 0.4 mm pitch

PLASTIC QUAD FLATPACK - NO LEAD

This image is a representation of the package family, actual package may vary.
Refer to the product data sheet for package details.

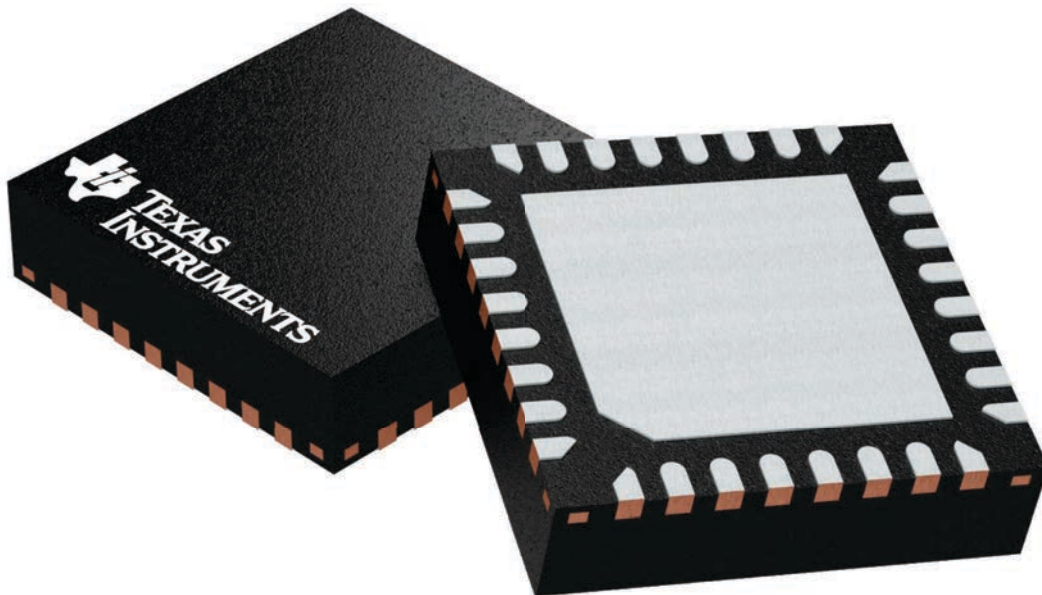

4224982/A

RSM0032B

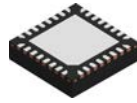

PACKAGE OUTLINE

VQFN - 1 mm max height

PLASTIC QUAD FLATPACK - NO LEAD

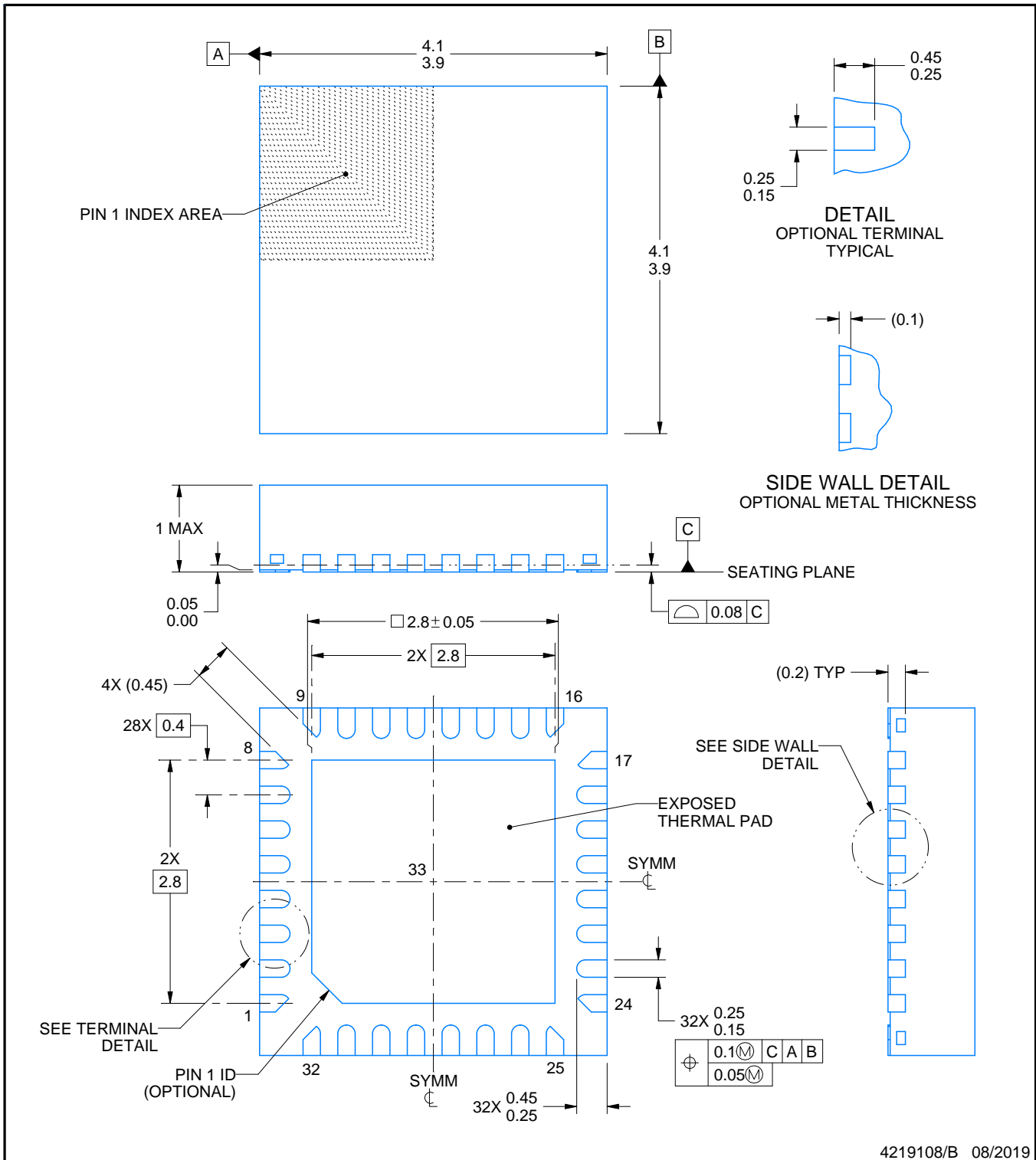

4219108/B 08/2019

NOTES:

1. All linear dimensions are in millimeters. Any dimensions in parenthesis are for reference only. Dimensioning and tolerancing per ASME Y14.5M.
2. This drawing is subject to change without notice.
3. The package thermal pad must be soldered to the printed circuit board for thermal and mechanical performance.

EXAMPLE BOARD LAYOUT

RSM0032B

VQFN - 1 mm max height

PLASTIC QUAD FLATPACK - NO LEAD

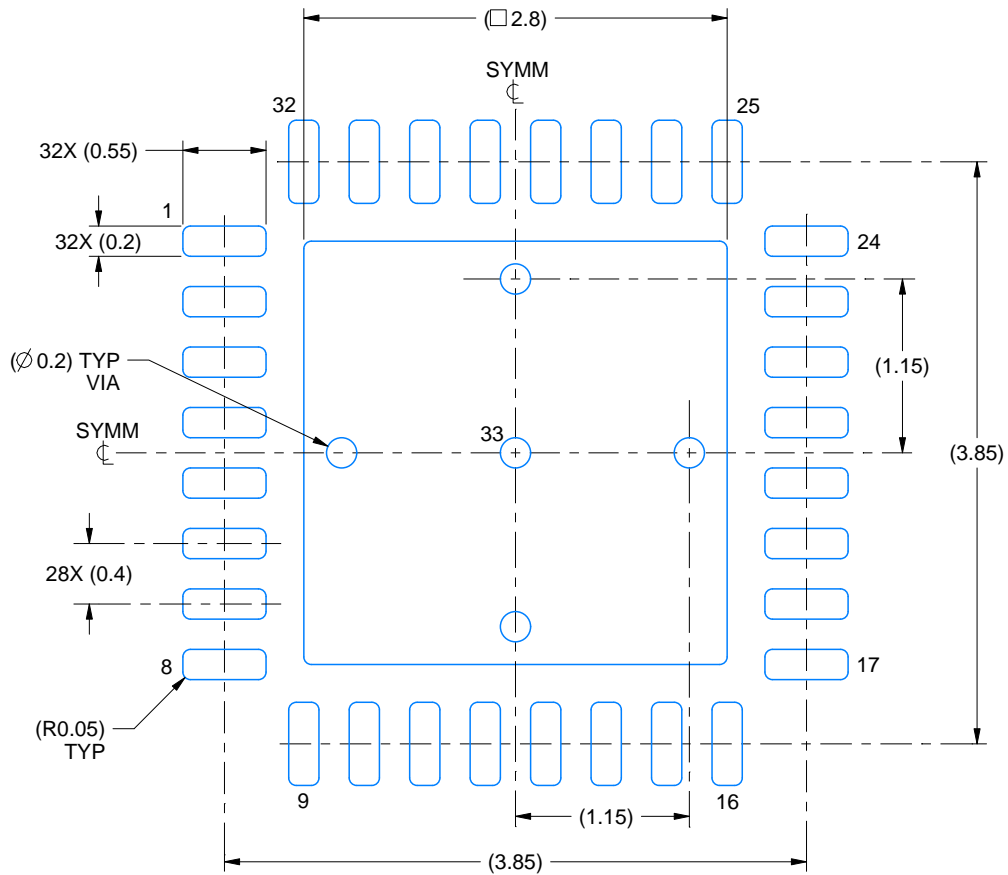

LAND PATTERN EXAMPLE
EXPOSED METAL SHOWN
SCALE:20X

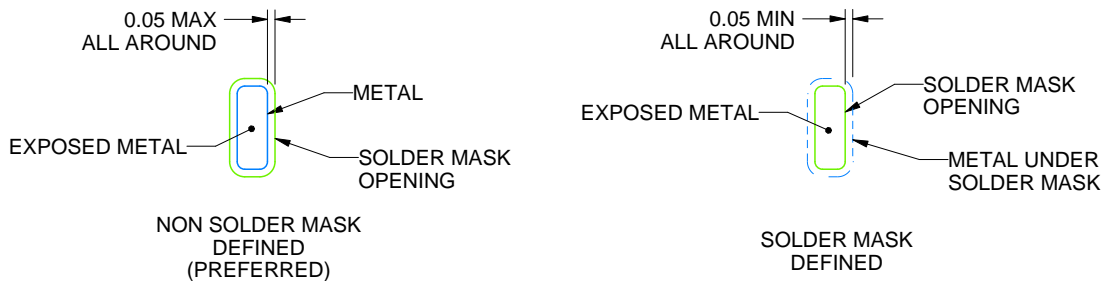

SOLDER MASK DETAILS

4219108/B 08/2019

NOTES: (continued)

- This package is designed to be soldered to a thermal pad on the board. For more information, see Texas Instruments literature number SLUA271 (www.ti.com/lit/sluea271).
- Vias are optional depending on application, refer to device data sheet. If any vias are implemented, refer to their locations shown on this view. It is recommended that vias under paste be filled, plugged or tented.

EXAMPLE STENCIL DESIGN

RSM0032B

VQFN - 1 mm max height

PLASTIC QUAD FLATPACK - NO LEAD

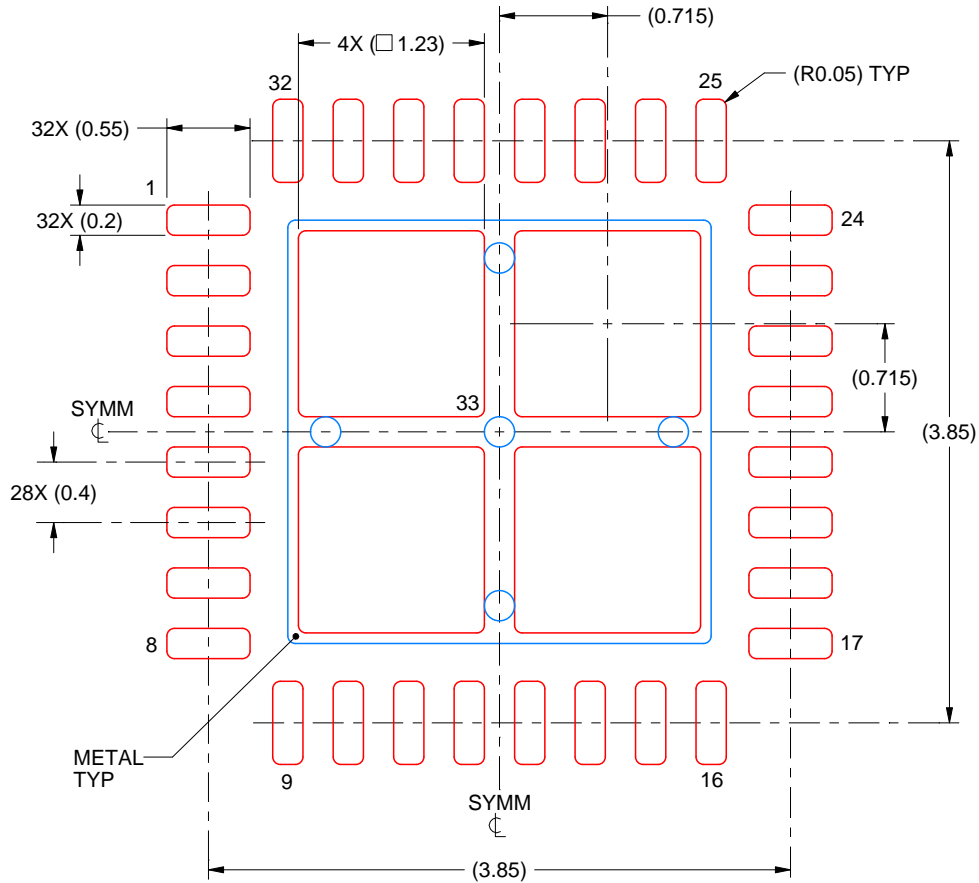

SOLDER PASTE EXAMPLE
BASED ON 0.1 mm THICK STENCIL

EXPOSED PAD 33:
77% PRINTED SOLDER COVERAGE BY AREA UNDER PACKAGE
SCALE:20X

4219108/B 08/2019

NOTES: (continued)

6. Laser cutting apertures with trapezoidal walls and rounded corners may offer better paste release. IPC-7525 may have alternate design recommendations.

IMPORTANT NOTICE AND DISCLAIMER

TI PROVIDES TECHNICAL AND RELIABILITY DATA (INCLUDING DATASHEETS), DESIGN RESOURCES (INCLUDING REFERENCE DESIGNS), APPLICATION OR OTHER DESIGN ADVICE, WEB TOOLS, SAFETY INFORMATION, AND OTHER RESOURCES "AS IS" AND WITH ALL FAULTS, AND DISCLAIMS ALL WARRANTIES, EXPRESS AND IMPLIED, INCLUDING WITHOUT LIMITATION ANY IMPLIED WARRANTIES OF MERCHANTABILITY, FITNESS FOR A PARTICULAR PURPOSE OR NON-INFRINGEMENT OF THIRD PARTY INTELLECTUAL PROPERTY RIGHTS.

These resources are intended for skilled developers designing with TI products. You are solely responsible for (1) selecting the appropriate TI products for your application, (2) designing, validating and testing your application, and (3) ensuring your application meets applicable standards, and any other safety, security, or other requirements. These resources are subject to change without notice. TI grants you permission to use these resources only for development of an application that uses the TI products described in the resource. Other reproduction and display of these resources is prohibited. No license is granted to any other TI intellectual property right or to any third party intellectual property right. TI disclaims responsibility for, and you will fully indemnify TI and its representatives against, any claims, damages, costs, losses, and liabilities arising out of your use of these resources.

TI's products are provided subject to TI's Terms of Sale (<https://www.ti.com/legal/termsofsale.html>) or other applicable terms available either on [ti.com](https://www.ti.com) or provided in conjunction with such TI products. TI's provision of these resources does not expand or otherwise alter TI's applicable warranties or warranty disclaimers for TI products.

Mailing Address: Texas Instruments, Post Office Box 655303, Dallas, Texas 75265
Copyright © 2021, Texas Instruments Incorporated

单击下面可查看定价，库存，交付和生命周期等信息

[>>TI\(德州仪器\)](#)