

TPA3111D1 10-W Filter-Free Mono Class-D Audio Power Amplifier With Speaker Guard™

1 Features

- 10-W into an 8-Ω Load at 10% THD+N From a 12-V Supply
- 7-W into an 4-Ω Load at 10% THD+N From a 8-V Supply
- 94% Efficient Class-D Operation into 8-Ω Load Eliminates Need for Heat Sinks
- Wide Supply Voltage Range Allows Operation from 8 to 26 V
- Filter-Free Operation
- SpeakerGuard™ Speaker Protection Includes Adjustable Power Limiter Plus DC Protection
- Flow-Through Pinout Facilitates Easy Board Layout
- Robust Pin-to-Pin Short-Circuit Protection and Thermal Protection With Auto-Recovery Option
- Excellent THD+N and Pop-Free Performance
- Four Selectable, Fixed Gain Settings
- Differential Inputs

2 Applications

- Televisions
- Monitors and Laptops
- Consumer Audio Equipment

3 Description

The TPA3111D1 device is a 10-W, efficient, Class-D audio power amplifier for driving a bridge tied speaker. Advanced EMI suppression technology enables the use of inexpensive ferrite bead filters at the outputs while meeting EMC requirements. SpeakerGuard speaker protection system includes an adjustable power limiter and a DC detection circuit. The adjustable power limiter lets the user to set a virtual voltage rail lower than the chip supply to limit the current through the speaker. The DC Detect circuit measures the frequency and amplitude of the PWM signal and shuts off the output stage if the input capacitors are damaged or shorts exist on the inputs.

The TPA3111D1 can drive a mono speaker as low as 4 Ω. The high efficiency of the TPA3111D1, >90%, eliminates the requirement for an external heat sink when playing music.

The outputs are fully protected against shorts to GND, V_{CC} , and output-to-output. The short-circuit protection and thermal protection includes an auto-recovery feature.

Device Information⁽¹⁾

PART NUMBER	PACKAGE	BODY SIZE (NOM)
TPA3111D1	HTSSOP (28)	4.40 mm x 9.70 mm

(1) For all available packages, see the orderable addendum at the end of the data sheet.

Simplified Application Diagram

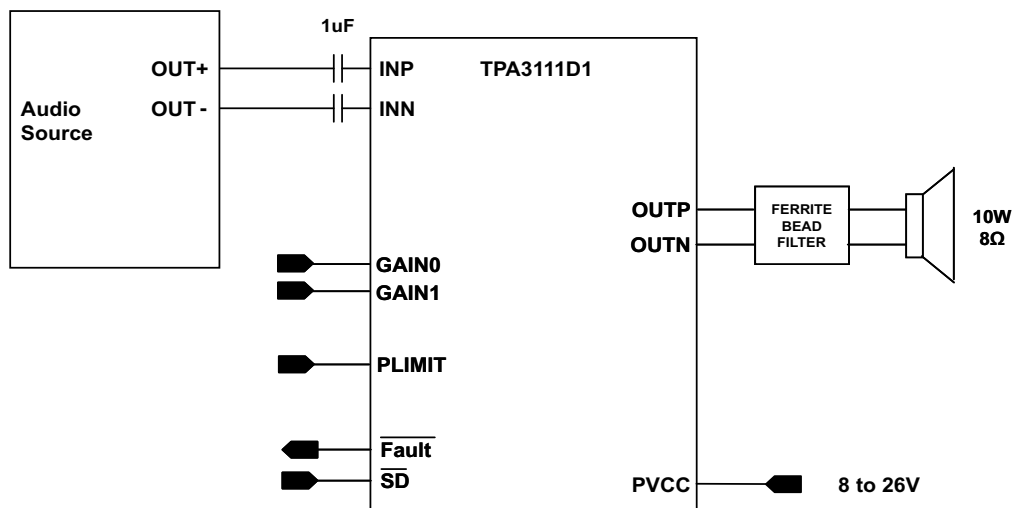

Copyright © 2016, Texas Instruments Incorporated



An IMPORTANT NOTICE at the end of this data sheet addresses availability, warranty, changes, use in safety-critical applications, intellectual property matters and other important disclaimers. PRODUCTION DATA.

Table of Contents

1 Features	1	7.3 Feature Description	11
2 Applications	1	7.4 Device Functional Modes	14
3 Description	1	8 Application and Implementation	15
4 Revision History	2	8.1 Application Information	15
5 Pin Configuration and Functions	3	8.2 Typical Application	15
6 Specifications	4	9 Power Supply Recommendations	20
6.1 Absolute Maximum Ratings	4	10 Layout	21
6.2 ESD Ratings	4	10.1 Layout Guidelines	21
6.3 Recommended Operating Conditions	5	10.2 Layout Example	22
6.4 Thermal Information	5	11 Device and Documentation Support	23
6.5 DC Characteristics – $V_{CC} = 24\text{ V}$	5	11.1 Device Support	23
6.6 DC Characteristics – $V_{CC} = 12\text{ V}$	5	11.2 Documentation Support	23
6.7 AC Characteristics – $V_{CC} = 24\text{ V}$	6	11.3 Receiving Notification of Documentation Updates	23
6.8 AC Characteristics – $V_{CC} = 12\text{ V}$	6	11.4 Community Resources	23
6.9 Typical Characteristics	7	11.5 Trademarks	23
7 Detailed Description	10	11.6 Electrostatic Discharge Caution	23
7.1 Overview	10	11.7 Glossary	23
7.2 Functional Block Diagram	11	12 Mechanical, Packaging, and Orderable Information	23

4 Revision History

NOTE: Page numbers for previous revisions may differ from page numbers in the current version.

Changes from Revision E (August 2012) to Revision F Page

- Added *Device Information* table, *ESD Ratings* table, *Feature Description* section, *Device Functional Modes* section, *Application and Implementation* section, *Power Supply Recommendations* section, *Layout* section, *Device and Documentation Support* section, and *Mechanical, Packaging, and Orderable Information* section..... **1**

Changes from Revision D (July 2012) to Revision E Page

- Changed 0.1 mF to 0.1 μF and 220 mF to 220 μF **20**
- Changed 0.1 mF to 0.1 μF and 1 mF to 1 μF **21**

Changes from Revision C (October 2010) to Revision D Page

- Added a 100-k Ω resistor to AVCC (Pin 14) and Note 1 to [Figure 17](#)..... **15**

Changes from Revision B (August 2010) to Revision C Page

- Added $< 10\text{ V/ms}$ to V_I **4**

Changes from Revision A (July 2010) to Revision B Page

- Replaced the Dissipations Ratings Table with the Thermal Information Table..... **5**
- Changed the 220-nF capacitor rated for at least 25 V to 470-nF capacitor rated to at least 16 V **19**

Changes from Original (August 2009) to Revision A Page

- Added slew rate adjustment information **11**

5 Pin Configuration and Functions

PWP Package
28-Pin HTSSOP
Top View

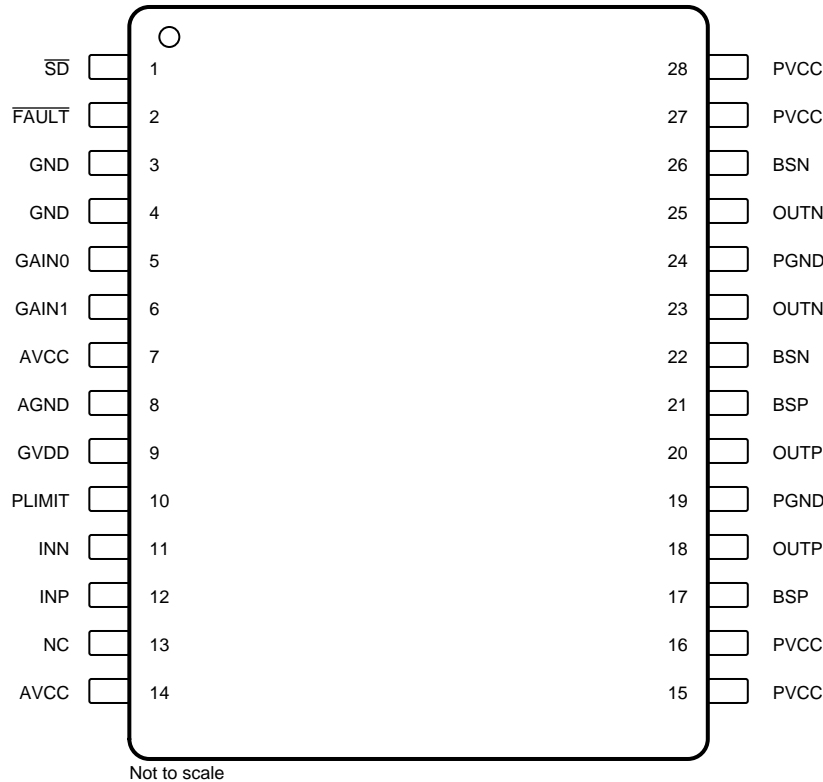

Pin Functions

PIN		I/O	DESCRIPTION
NAME	NO.		
AGND	8	—	Analog supply ground. Connect to the thermal pad.
AVCC	7	P	Analog supply. A 100-kΩ resistor in series with AVCC is needed if the PVCC slew rate is greater than 10 V/ms.
AVCC	14	P	Connect AVCC supply to this pin.
BSP	17	I	Bootstrap I/O for positive high-side FET.
BSP	21	I	Bootstrap I/O for positive high-side FET.
BSN	22	I	Bootstrap I/O for negative high-side FET.
BSN	26	I	Bootstrap I/O for negative high-side FET.
FAULT	2	O	Open-drain output used to display short-circuit or DC Detect Fault status. Voltage compliant to AVCC. Short-circuit faults can be set to auto-recovery by connecting FAULT pin to SD pin. Otherwise both short-circuit faults and DC Detect Faults must be reset by cycling PVCC.
GAIN0	5	I	Gain select least significant bit. TTL logic levels with compliance to AVCC.
GAIN1	6	I	Gain select most significant bit. TTL logic levels with compliance to AVCC.
GND	3	—	Connect to local ground
GND	4	—	Connect to local ground
GVDD	9	O	High-side FET gate drive supply. Nominal voltage is 7 V. Can also be used as supply for PLILIMIT divider. Add a 1-μF capacitor to ground at this pin.
INP	12	I	Positive audio input. Biased at 3 V.
INN	11	I	Negative audio input. Biased at 3 V.
NC	13	—	Not connected

Pin Functions (continued)

PIN		I/O	DESCRIPTION
NAME	NO.		
OUTP	18	O	Class-D H-bridge positive output.
OUTP	20	O	Class-D H-bridge positive output.
OUTN	23	O	Class-D H-bridge negative output.
OUTN	25	O	Class-D H-bridge negative output.
PGND	24	—	Power ground for the H-bridges.
PGND	19	—	Power ground for the H-bridges.
PLIMIT	10	I	Power limit level adjust. Connect directly to GVDD pin for no power limiting. Add a 1- μ F capacitor to ground at this pin.
PVCC	15	P	Power supply for H-bridge. PVCC pins are also connected internally.
PVCC	16	P	Power supply for H-bridge. PVCC pins are also connected internally.
PVCC	27	P	Power supply for H-bridge. PVCC pins are also connected internally.
PVCC	28	P	Power supply for H-bridge. PVCC pins are also connected internally.
\overline{SD}	1	I	Shutdown logic input for audio amplifier (LOW = outputs Hi-Z, HIGH = outputs enabled). TTL logic levels with compliance to AVCC.

6 Specifications

6.1 Absolute Maximum Ratings

 over operating free-air temperature range (unless otherwise noted)⁽¹⁾

		MIN	MAX	UNIT
Supply voltage, V_{CC}	AVCC, PVCC	-0.3	30	V
Interface pin voltage, V_I	\overline{SD} , \overline{FAULT} , GAIN0, GAIN1, AVCC (Pin 14) ⁽²⁾	-0.3	$V_{CC} + 0.3$	V
		<10		V/ms
	PLIMIT	-0.3	$V_{GVDD} + 0.3$	V
	INN, INP	-0.3	6.3	
Minimum load resistance, R_L	BTL	3.2		Ω
Continuous total power dissipation		See Thermal Information		
Operating free-air temperature, T_A		-40	85	$^{\circ}\text{C}$
Operating junction temperature, T_J ⁽³⁾		-40	150	$^{\circ}\text{C}$
Storage temperature, T_{stg}		-65	150	$^{\circ}\text{C}$

- (1) Stresses beyond those listed under *Absolute Maximum Ratings* may cause permanent damage to the device. These are stress ratings only, which do not imply functional operation of the device at these or any other conditions beyond those indicated under *Recommended Operating Conditions*. Exposure to absolute-maximum-rated conditions for extended periods may affect device reliability.
- (2) The voltage slew rate of these pins must be restricted to no more than 10 V/ms. For higher slew rates, use a 100-k Ω resistor in series with the pins.
- (3) The TPA3111D1 incorporates an exposed thermal pad on the underside of the chip. This acts as a heatsink, and it must be connected to a thermally dissipating plane for proper power dissipation. Failure to do so may result in the device going into thermal protection shutdown. See [Quad Flatpack No-Lead Logic Packages](#) and [QFN/SON PCB Attachment](#) for more information about using the QFN thermal pad. See [PowerPad™ Thermally Enhanced package](#) for more information about using the HTQFP thermal pad.

6.2 ESD Ratings

		VALUE	UNIT
$V_{(ESD)}$ Electrostatic discharge	Human-body model (HBM) ⁽¹⁾	± 2000	V
	Charged-device model (CDM) ⁽²⁾	± 500	

- (1) In accordance with JEDEC Standard 22, Test Method A114-B.
- (2) In accordance with JEDEC Standard 22, Test Method C101-A.

6.3 Recommended Operating Conditions

over operating free-air temperature range (unless otherwise noted)

			MIN	MAX	UNIT
V _{CC}	Supply voltage	PV _{CC} , AV _{CC}	8	26	V
V _{IH}	High-level input voltage	\overline{SD} , GAIN0, GAIN1	2		V
V _{IL}	Low-level input voltage	\overline{SD} , GAIN0, GAIN1		0.8	V
V _{OL}	Low-level output voltage	\overline{FAULT} , R _{PULLUP} = 100 k Ω , V _{CC} = 26 V		0.8	V
I _{IH}	High-level input current	\overline{SD} , GAIN0, GAIN1, V _I = 2 V, V _{CC} = 18 V		50	μ A
I _{IL}	Low-level input current	\overline{SD} , GAIN0, GAIN1, V _I = 0.8 V, V _{CC} = 18 V		5	μ A

6.4 Thermal Information

THERMAL METRIC ⁽¹⁾⁽²⁾		TPA311D1		UNIT
		PWP (HTSSOP)		
		28 PINS		
R _{θJA}	Junction-to-ambient thermal resistance	30.3		°C/W
R _{θJC(top)}	Junction-to-case (top) thermal resistance	33.5		°C/W
R _{θJB}	Junction-to-board thermal resistance	17.5		°C/W
ψ _{JT}	Junction-to-top characterization parameter	0.9		°C/W
ψ _{JB}	Junction-to-board characterization parameter	7.2		°C/W
R _{θJC(bot)}	Junction-to-case (bottom) thermal resistance	0.9		°C/W

- For more information about traditional and new thermal metrics, see the [Semiconductor and IC Package Thermal Metrics](#) application report.
- For thermal estimates of this device based on PCB copper area, see the [TI PCB Thermal Calculator](#).

6.5 DC Characteristics – V_{CC} = 24 V

T_A = 25°C, R_L = 8 Ω (unless otherwise noted)

PARAMETER		TEST CONDITIONS		MIN	TYP	MAX	UNIT
V _{OS}	Class-D output offset voltage (measured differentially)	V _I = 0 V, Gain = 36 dB			1.5	15	mA
I _{CC}	Quiescent supply current	\overline{SD} = 2 V, no load, PV _{CC} = 21 V			40		mA
I _{CC(SD)}	Quiescent supply current in shutdown mode	\overline{SD} = 0.8 V, no load, PV _{CC} = 21 V			400		μ A
R _{DS(ON)}	Drain-source ON-state resistance	I _O = 500 mA, T _J = 25°C	High side		240		m Ω
			Low side		240		
G	Gain	V _{GAIN1} = 0.8 V	V _{GAIN0} = 0.8 V	19	20	21	dB
			V _{GAIN0} = 2 V	25	26	27	
		V _{GAIN1} = 2 V	V _{GAIN0} = 0.8 V	31	32	33	
			V _{GAIN0} = 2 V	35	36	37	
t _{ON}	Turnon time	\overline{VSD} = 2 V			10		ms
t _{OFF}	Turnoff time	\overline{VSD} = 0.8 V			2		μ s
V _{GVDD}	Gate drive supply	I _{GVDD} = 2 mA		6.5	6.9	7.3	V

6.6 DC Characteristics – V_{CC} = 12 V

T_A = 25°C, R_L = 8 Ω (unless otherwise noted)

PARAMETER		TEST CONDITIONS		MIN	TYP	MAX	UNIT
V _{OS}	Class-D output offset voltage (measured differentially)	V _I = 0 V, Gain = 36 dB			1.5	15	mA
I _{CC}	Quiescent supply current	\overline{SD} = 2 V, no load, PV _{CC} = 12 V			20		mA
I _{CC(SD)}	Quiescent supply current in shutdown mode	\overline{SD} = 0.8 V, no load, PV _{CC} = 12 V			200		μ A
R _{DS(ON)}	Drain-source ON-state resistance	I _O = 500 mA, T _J = 25°C	High side		240		m Ω
			Low side		240		

DC Characteristics – $V_{CC} = 12\text{ V}$ (continued)

 $T_A = 25^\circ\text{C}$, $R_L = 8\ \Omega$ (unless otherwise noted)

PARAMETER		TEST CONDITIONS	MIN	TYP	MAX	UNIT	
G	Gain	$V_{GAIN1} = 0.8\text{ V}$	$V_{GAIN0} = 0.8\text{ V}$	19	20	21	dB
			$V_{GAIN0} = 2\text{ V}$	25	26	27	
		$V_{GAIN1} = 2\text{ V}$	$V_{GAIN0} = 0.8\text{ V}$	31	32	33	
			$V_{GAIN0} = 2\text{ V}$	35	36	37	
t_{ON}	Turnon time	$V_{SD} = 2\text{ V}$		10		ms	
t_{OFF}	Turnoff time	$V_{SD} = 0.8\text{ V}$		2		μs	
V_{GVDD}	Gate drive supply	$I_{GVDD} = 2\text{ mA}$	6.5	6.9	7.3	V	
PLIMIT	Output voltage maximum under PLIMIT control	$V_{PLIMIT} = 2\text{ V}$, $V_I = 6\text{ V}$ differential	6.75	7.9	8.75	V	

6.7 AC Characteristics – $V_{CC} = 24\text{ V}$

 $T_A = 25^\circ\text{C}$, $R_L = 8\ \Omega$ (unless otherwise noted)

PARAMETER		TEST CONDITIONS	MIN	TYP	MAX	UNIT
K_{SVR}	Power supply ripple rejection	200-mV _{PP} ripple from 20 Hz to 1 kHz, Gain = 20 dB, Inputs AC-coupled to AGND		-70		dB
P_O	Continuous output power	$f = 1\text{ kHz}$, $V_{CC} = 24\text{ V}$, $\text{THD+N} \leq 0.1\%$		10		W
THD+N	Total harmonic distortion + noise	$f = 1\text{ kHz}$, $V_{CC} = 24\text{ V}$, $P_O = 5\text{ W}$ (half-power)		<0.05%		
V_N	Output integrated noise	20 Hz to 22 kHz, A-weighted filter, Gain = 20 dB		65		μV
				-80		dBV
	Crosstalk	$f = 1\text{ kHz}$, $V_O = 1\text{ V}_{\text{rms}}$, Gain = 20 dB		-70		dB
SNR	Signal-to-noise ratio	Maximum output at $\text{THD+N} < 1\%$, $f = 1\text{ kHz}$, Gain = 20 dB, A-weighted		102		dB
f_{OSC}	Oscillator frequency		250	310	350	kHz
	Thermal trip point			150		$^\circ\text{C}$
	Thermal hysteresis			15		$^\circ\text{C}$

6.8 AC Characteristics – $V_{CC} = 12\text{ V}$

 $T_A = 25^\circ\text{C}$, $R_L = 8\ \Omega$ (unless otherwise noted)

PARAMETER		TEST CONDITIONS	MIN	TYP	MAX	UNIT
K_{SVR}	Power supply ripple rejection	200-mV _{PP} ripple from 20 Hz to 1 kHz, Gain = 20 dB, Inputs AC-coupled to AGND		-70		dB
P_O	Continuous output power	$f = 1\text{ kHz}$, $R_L = 8\ \Omega$, $\text{THD+N} \leq 10\%$		10		W
		$f = 1\text{ kHz}$, $R_L = 4\ \Omega$, $\text{THD+N} \leq 0.1\%$		10		
THD+N	Total harmonic distortion + noise	$f = 1\text{ kHz}$, $R_L = 8\ \Omega$, $P_O = 5\text{ W}$ (half-power)		<0.06%		
V_N	Output integrated noise	20 Hz to 22 kHz, A-weighted filter, Gain = 20 dB		65		μV
				-80		dBV
	Crosstalk	$f = 1\text{ kHz}$, $P_O = 1\text{ W}$, Gain = 20 dB		-70		dB
SNR	Signal-to-noise ratio	Maximum output at $\text{THD+N} < 1\%$, $f = 1\text{ kHz}$, Gain = 20 dB, A-weighted		102		dB
f_{OSC}	Oscillator frequency		250	310	350	kHz
	Thermal trip point			150		$^\circ\text{C}$
	Thermal hysteresis			15		$^\circ\text{C}$

6.9 Typical Characteristics

All measurements taken at 1 kHz, unless otherwise noted. Measurements were made using the TPA3111D1 EVM.

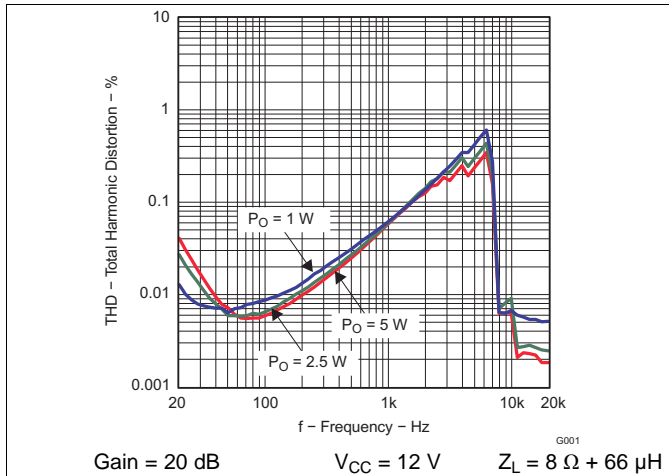

Figure 1. Total Harmonic Distortion vs Frequency

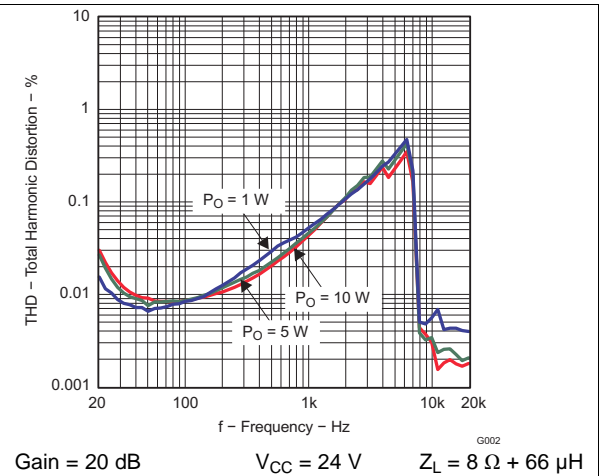

Figure 2. Total Harmonic Distortion vs Frequency

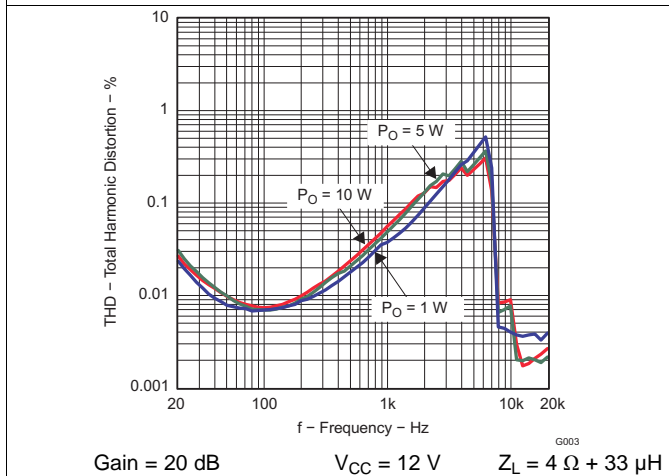

Figure 3. Total Harmonic Distortion vs Frequency

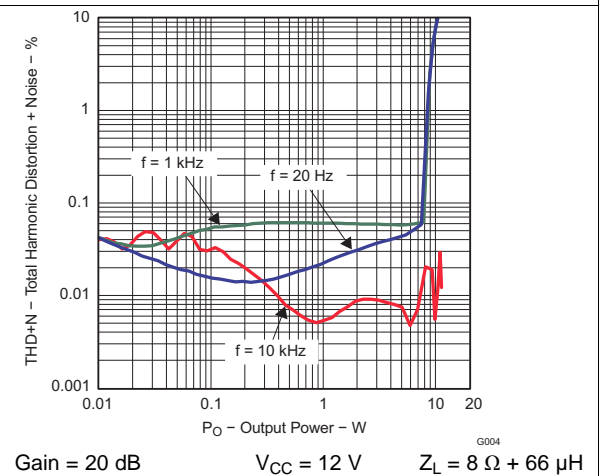

Figure 4. Total Harmonic Distortion + Noise vs Output Power

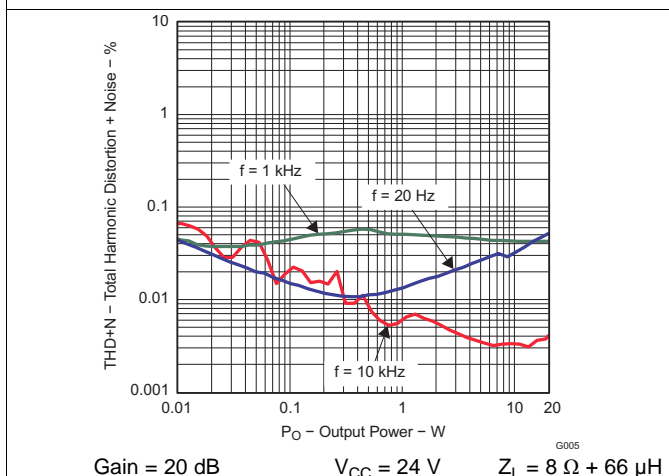

Figure 5. Total Harmonic Distortion + Noise vs Output Power

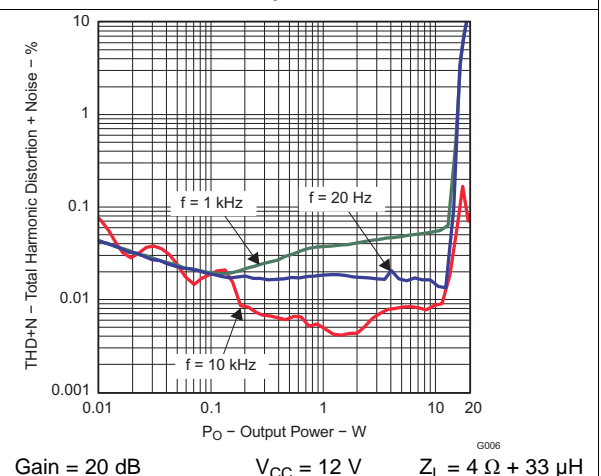
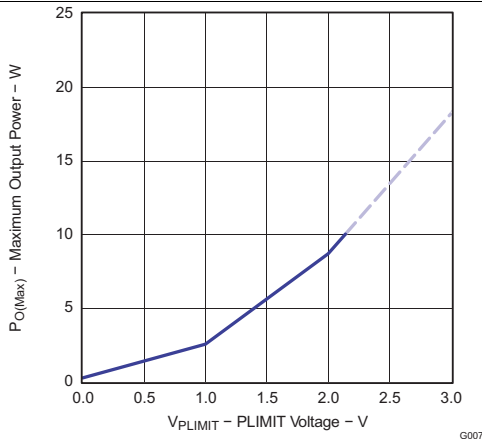

Figure 6. Total Harmonic Distortion + Noise vs Output Power

Typical Characteristics (continued)

All measurements taken at 1 kHz, unless otherwise noted. Measurements were made using the TPA3111D1 EVM.



Dashed line represents thermally limited region.
Gain = 20 dB $V_{CC} = 24\text{ V}$ $Z_L = 8\ \Omega + 66\ \mu\text{H}$

Figure 7. Maximum Output Power vs PLIMIT Voltage

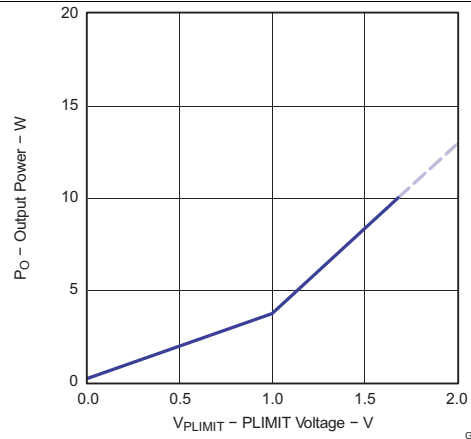

Dashed line represents thermally limited region.
Gain = 20 dB $V_{CC} = 12\text{ V}$ $Z_L = 4\ \Omega + 33\ \mu\text{H}$

Figure 8. Output Power vs PLIMIT Voltage

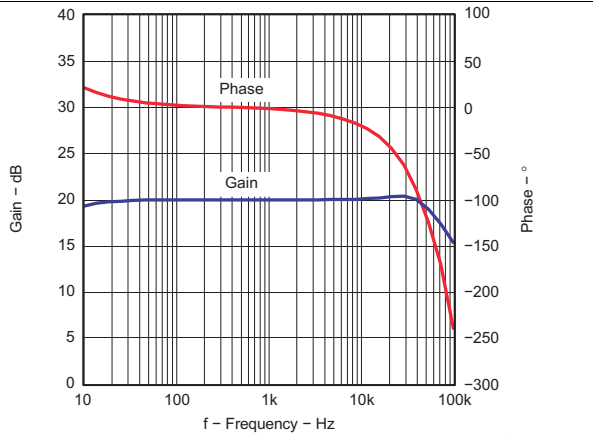

Gain = 20 dB $V_{CC} = 12\text{ V}$ $Z_L = 8\ \Omega + 66\ \mu\text{H}$
 $C_1 = \mu\text{F}$ $V_1 = 0.1\text{ V}_{RMS}$
Filter = Audio Precision AUX-0225

Figure 9. Gain/Phase vs Frequency

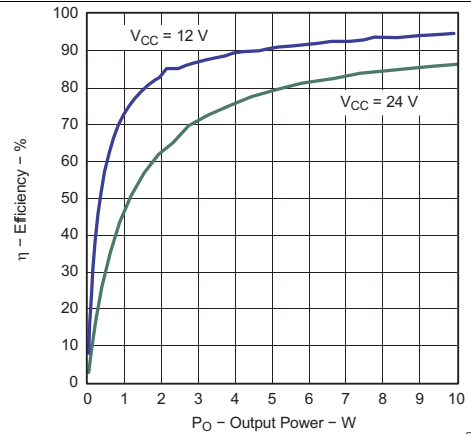

Gain = 20 dB $Z_L = 8\ \Omega + 66\ \mu\text{H}$

Figure 10. Efficiency vs Output Power

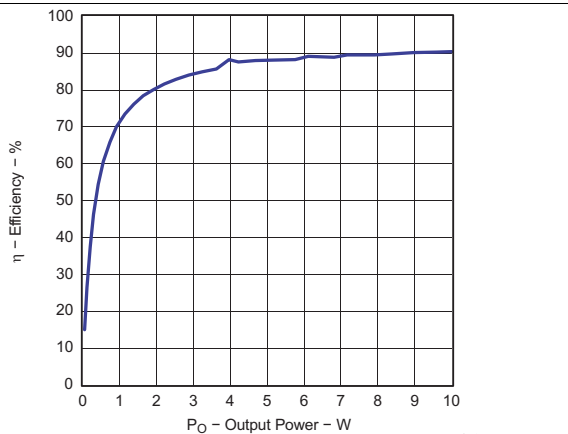

Gain = 20 dB $V_{CC} = 12\text{ V}$ $Z_L = 4\ \Omega + 33\ \mu\text{H}$

Figure 11. Efficiency vs Output Power

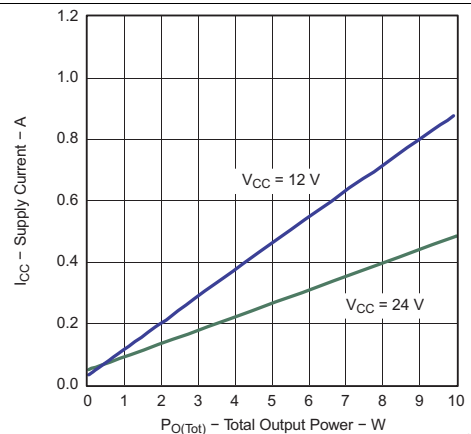

Gain = 20 dB $Z_L = 8\ \Omega + 66\ \mu\text{H}$

Figure 12. Supply Current vs Total Output Power

Typical Characteristics (continued)

All measurements taken at 1 kHz, unless otherwise noted. Measurements were made using the TPA3111D1 EVM.

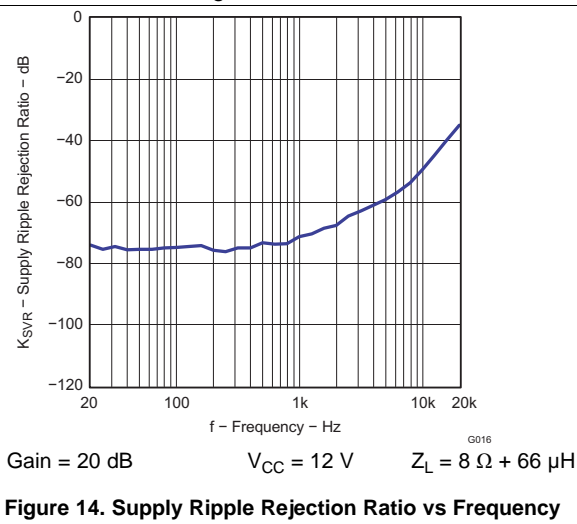
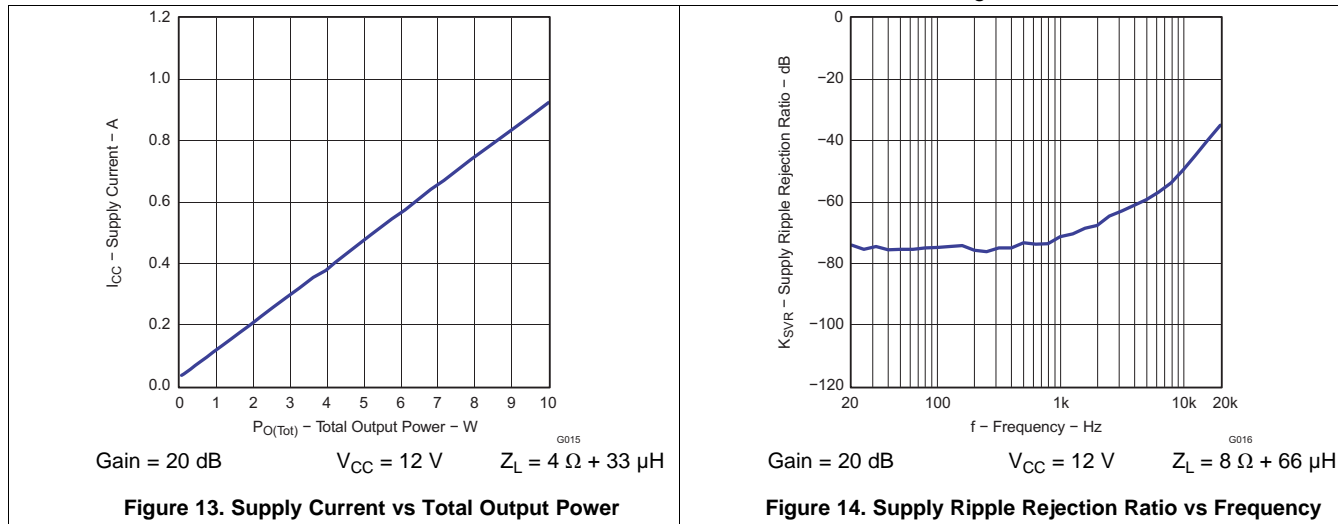

7 Detailed Description

7.1 Overview

To facilitate system design, the TPA3111D1 requires only a single power supply from 8 V to 26 V for operation. An internal voltage regulator provides suitable voltage levels for the gate driver, digital and low-voltage analog circuitry. Additionally, all circuitry requiring a floating voltage supply, that is, the high-side gate drive, is accommodated by built-in bootstrap circuitry with integrated bootstrap diodes requiring only an external capacitor for each half-bridge. The audio signal path, including the gate drive and output stage is designed as identical, independent full-bridges. Place all decoupling capacitors as close to their associated pins as possible. In general, the physical loop with the power supply pins, decoupling capacitors and GND return path to the device pins must be kept as short as possible and with as little area as possible to minimize induction (see [TPA3111D1 Evaluation Module](#) for additional information).

For a properly functioning bootstrap circuit, a small ceramic capacitor must be connected from each bootstrap pin (BSx) to the power-stage output pin (OUTx). When the power-stage output is low, the bootstrap capacitor is charged through an internal diode connected between the gate-drive power-supply pin (GVDD) and the bootstrap pins. When the power-stage output is high, the bootstrap capacitor potential is shifted above the output potential and thus provides a suitable voltage supply for the high-side gate driver. In an application with PWM switching frequencies approximately 310 kHz, TI recommends ceramic capacitors with at least 220-nF capacitance, size 0603 or 0805, for the bootstrap supply. These capacitors ensure sufficient energy storage, even during clipped low frequency audio signals, to keep the high-side power stage FET (LDMOS) fully turned on during the remaining part of its ON cycle. Pay special attention to the power-stage power supply; this includes component selection, PCB placement, and routing. For optimal electrical performance, EMI compliance, and system reliability, it is important that each PVCC pin is decoupled with ceramic capacitors placed as close as possible to each supply pin. TI recommends following the PCB layout of the TPA3111D1 EVM. For additional information on recommended power supply and required components, see [Application and Implementation](#) and [Power Supply Recommendations](#). The PVCC power supply must have low output impedance and low noise. The power-supply ramp and \overline{SD} release sequence is not critical for device reliability as facilitated by the internal power-on-reset circuit, but TI recommends releasing \overline{SD} after the power supply is settled for minimum turnon audible artifacts.

7.2 Functional Block Diagram

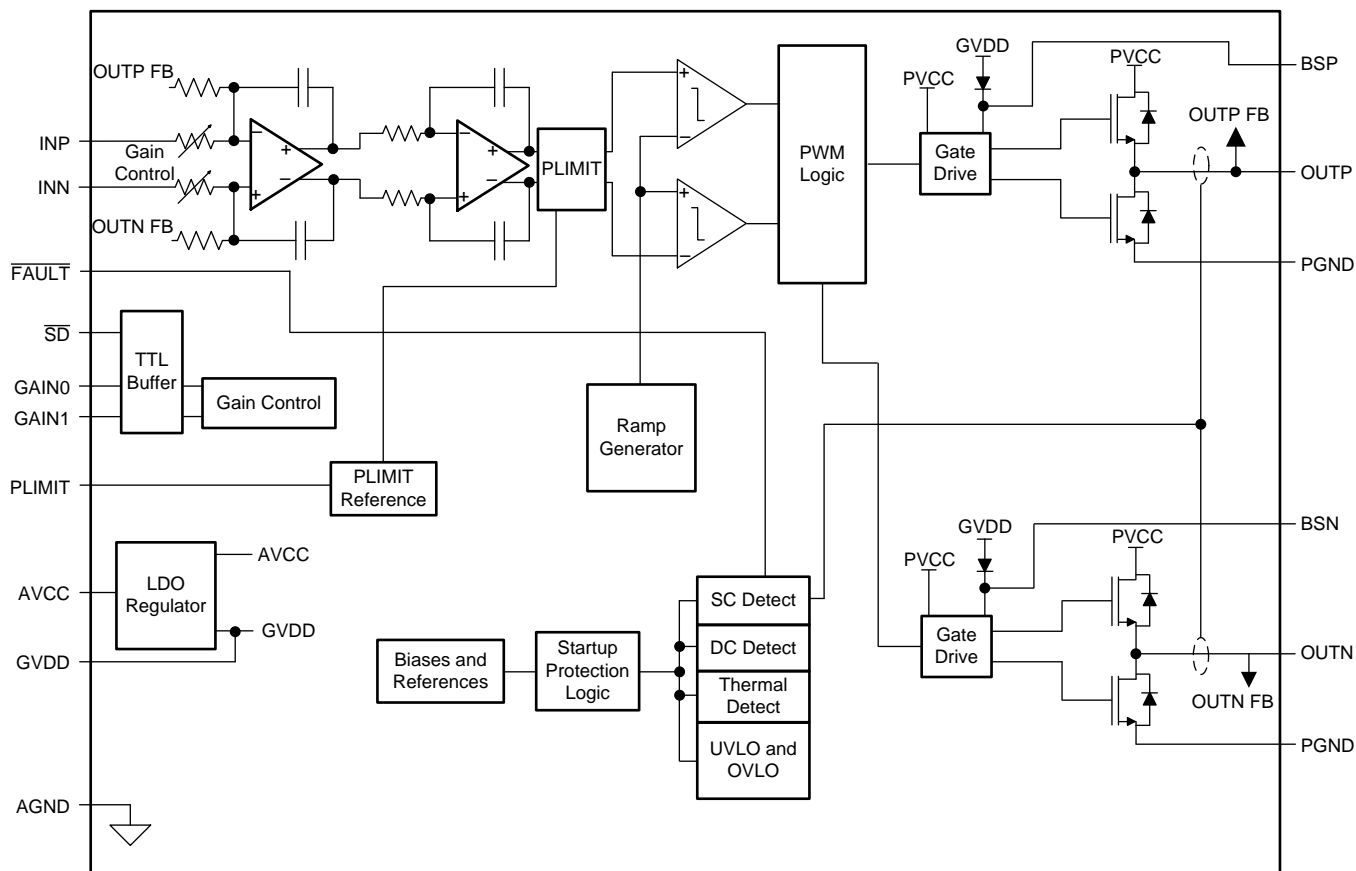

Copyright © 2016, Texas Instruments Incorporated

7.3 Feature Description

7.3.1 Gain Setting Through GAIN0 and GAIN1 Inputs

The gain of the TPA3111D1 is set by two input pins, GAIN0 and GAIN1. The voltage slew rate of these gain pins, along with SD and AVCC (pin 14), must be restricted to no more than 10 V/ms. For higher slew rates, use a 100-kΩ resistor in series with the pins.

The gains listed in [Table 1](#) are realized by changing the taps on the input resistors inside the amplifier. This causes the input impedance (Z_i) to be dependent on the gain setting. The actual gain settings are controlled by ratios of resistors, so the gain variation from part-to-part is small. However, the input impedance from part to part at the same gain may shift by $\pm 20\%$ due to shifts in the actual resistance of the input resistors.

For design purposes, the input network must be designed assuming an input impedance of 7.2 kΩ, which is the absolute minimum input impedance of the TPA3111D1. At the lower gain settings, the input impedance could increase as high as 72 kΩ

Table 1. Gain Setting

GAIN1	GAIN0	AMPLIFIER GAIN (dB)	INPUT IMPEDANCE (kΩ)
		TYPICAL	TYPICAL
0	0	20	60
0	1	26	30
1	0	32	15
1	1	36	9

7.3.2 \overline{SD} Operation

The TPA3111D1 employs a shutdown mode of operation designed to reduce supply current (I_{CC}) to the absolute minimum level during periods of nonuse for power conservation. The \overline{SD} input pin must be held high (see specification table for trip point) during normal operation when the amplifier is in use. Pulling \overline{SD} low causes the outputs to mute and the amplifier to enter a low-current state. Never leave \overline{SD} unconnected, because amplifier operation would be unpredictable.

For the best power-off pop performance, place the amplifier in the shutdown mode before removing the power supply voltage.

7.3.3 PLIMIT

The voltage at pin 10 can be used to limit the power to levels less than what is possible based on the supply rail. Add a resistor divider from GVDD to ground to set the voltage at the PLIMIT pin. An external reference may also be used if tighter tolerance is required. Also add a 1- μ F capacitor from pin 10 to ground.

The PLIMIT circuit sets a limit on the output peak-to-peak voltage. This limit can be thought of as a virtual voltage rail which is lower than the supply connected to PVCC. This virtual rail is 4 times the voltage at the PLIMIT pin. This output voltage can be used to calculate the maximum output power for a given maximum input voltage and speaker impedance.

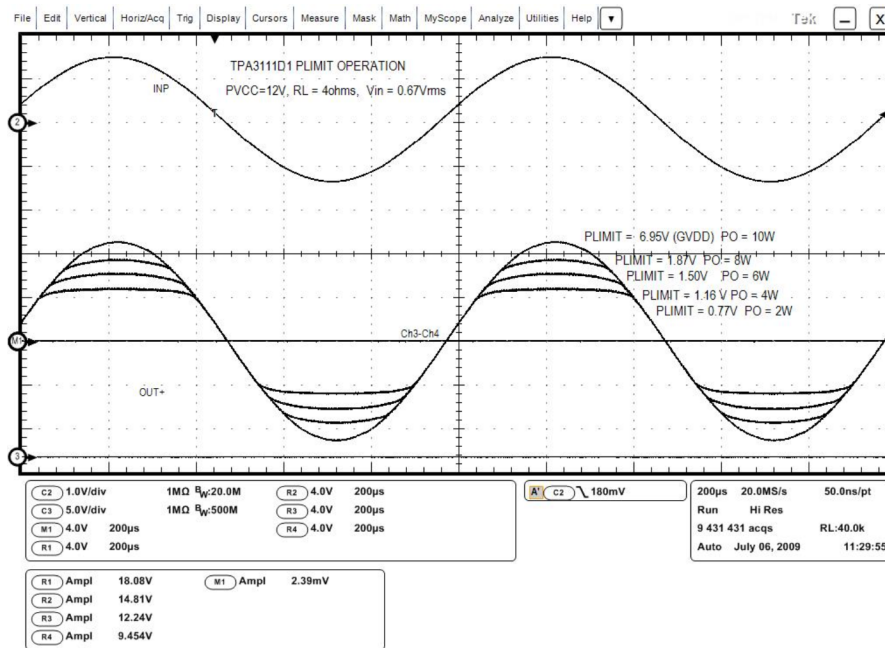

Figure 15. PLIMIT Circuit Operation

The PLIMIT circuit sets a limit on the output peak-to-peak voltage. The limiting is done by limiting the duty cycle to fixed maximum value. This limit can be thought of as a virtual voltage rail which is lower than the supply connected to PVCC. This virtual rail is 4 times the voltage at the PLIMIT pin. This output voltage can be used to calculate the maximum output power for a given maximum input voltage and speaker impedance.

$$P_{OUT} = \frac{\left(\left(\frac{R_L}{R_L + 2 \times R_S} \right) \times V_P \right)^2}{2 \times R_L} \quad \text{for unclipped power}$$

where

- R_S is the total series resistance including $R_{DS(on)}$, and any resistance in the output filter.
- R_L is the load resistance.
- V_P is the peak amplitude of the output possible within the supply rail.
 - $V_P = 4 \times \text{PLIMIT}$ voltage if $\text{PLIMIT} < 4 \times V_P$
 - $P_{OUT}(10\%THD) = 1.25 \times P_{OUT}(\text{unclipped})$

(1)

Table 2. PLIMIT Typical Operation

TEST CONDITIONS	PLIMIT VOLTAGE	OUTPUT POWER (W)	OUTPUT VOLTAGE AMPLITUDE (V_{P-P})
$V_{CC} = 24 \text{ V}$, $V_{IN} = 1 \text{ Vrms}$, $RL = 4 \Omega$, Gain = 20 dB	1.92	10	15
$V_{CC} = 24 \text{ V}$, $V_{IN} = 1 \text{ Vrms}$, $RL = 4 \Omega$, Gain = 20 dB	1.24	5	10
$V_{CC} = 12 \text{ V}$, $V_{IN} = 1 \text{ Vrms}$, $RL = 4 \Omega$, Gain = 20 dB	1.75	10	15.3
$V_{CC} = 12 \text{ V}$, $V_{IN} = 1 \text{ Vrms}$, $RL = 4 \Omega$, Gain = 20 dB	1.2	5	10.3

7.3.4 GVDD Supply

The GVDD supply is used to power the gates of the output full bridge transistors. It can also be used to supply the PLIMIT voltage divider circuit. Add a 1- μF capacitor to ground at this pin.

7.3.5 DC Detect

TPA3111D1 has circuitry which protects the speakers from DC current that might occur due to defective capacitors on the input or shorts on the printed-circuit board at the inputs. A DC Detect Fault is reported on the FAULT pin as a low state. The DC Detect Fault also causes the amplifier to shutdown by changing the state of the outputs to Hi-Z. To clear the DC Detect it is necessary to cycle the PVCC supply. Cycling SD does not clear a DC Detect Fault.

A DC Detect Fault is issued when the output differential duty-cycle exceeds 14% (for example, 57% or –43%) for more than 420 ms at the same polarity. This feature protects the speaker from large DC currents or AC currents less than 2 Hz. To avoid nuisance faults due to the DC Detect circuit, hold the SD pin low at power-up until the signals at the inputs are stable. Also, take care to match the impedance seen at the positive and negative input to avoid nuisance DC Detect Faults.

The minimum differential input voltages required to trigger the DC Detect are shown in Table 3. The inputs must remain at or above the voltage listed in the table for more than 420 ms to trigger the DC Detect.

Table 3. DC Detect Threshold

AV (dB)	V_{IN} (mV, DIFFERENTIAL)
20	112
26	56
32	28
36	17

7.3.6 Short-Circuit Protection and Automatic Recovery Feature

TPA3111D1 has protection from overcurrent conditions caused by a short circuit on the output stage. The short circuit protection fault is reported on the FAULT pin as a low state. The amplifier outputs are switched to a Hi-Z state when the short-circuit protection latch is engaged. The latch can be cleared by cycling the SD pin through the low state.

If automatic recovery from the short-circuit protection latch is desired, connect the $\overline{\text{FAULT}}$ pin directly to the $\overline{\text{SD}}$ pin. This allows the $\overline{\text{FAULT}}$ pin function to automatically drive the $\overline{\text{SD}}$ pin low that clears the short-circuit protection latch.

7.3.7 Thermal Protection

Thermal protection on the TPA3111D1 prevents damage to the device when the internal die temperature exceeds 150°C. There is a $\pm 15^\circ\text{C}$ tolerance on this trip point from device to device. When the die temperature exceeds the thermal set point, the device enters into the shutdown state and the outputs are disabled. This is not a latched fault. The thermal fault is cleared once the temperature of the die is reduced by 15°C. The device begins normal operation at this point with no external system interaction.

Thermal protection faults are NOT reported on the $\overline{\text{FAULT}}$ pin.

7.4 Device Functional Modes

7.4.1 TPA3111D1 Modulation Scheme

The TPA3111D1 uses a modulation scheme that allows operation without the classic LC reconstruction filter when the amp is driving an inductive load. Each output is switching from 0 V to the supply voltage. The OUTP and OUTN are in phase with each other with no input so that there is little or no current in the speaker. The duty cycle of OUTP is greater than 50% and OUTN is less than 50% for positive output voltages. The duty cycle of OUTP is less than 50% and OUTN is greater than 50% for negative output voltages. The voltage across the load sits at 0 V throughout most of the switching period, greatly reducing the switching current, which reduces any I^2R losses in the load.

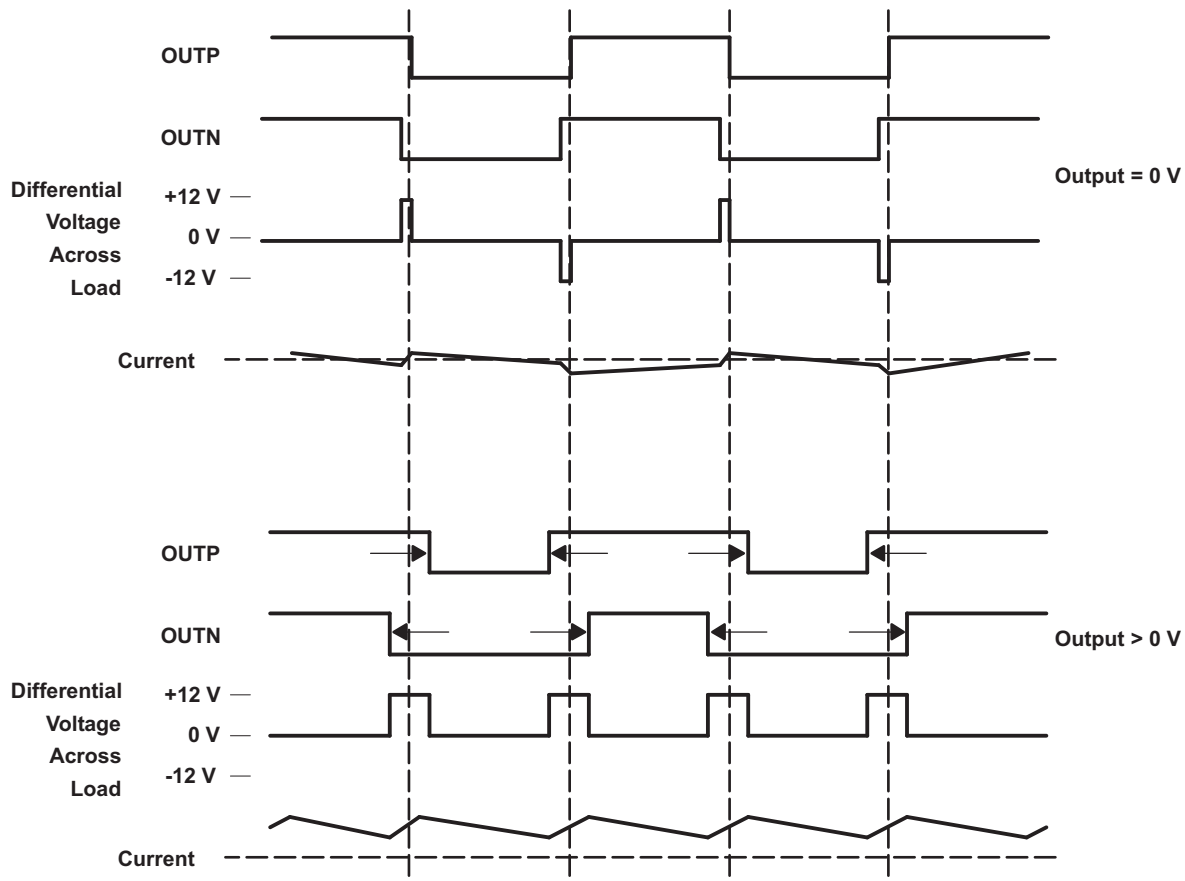

Figure 16. The TPA3111D1 Output Voltage and Current Waveforms into an Inductive Load

Typical Application (continued)

8.2.1 Design Requirements

For this design example, use the parameters listed in [Table 4](#) as the input parameters.

Table 4. Design Parameters

PARAMETER	EXAMPLE VALUE
Input voltage range PVDD	8 V to 26 V
Ferrite bead + capacitor	120 Ω to 600 Ω at 1 MHz + 1 nF / 2.2 nF

8.2.2 Detailed Design Procedure

8.2.2.1 Ferrite Bead Filter Considerations

Using the Advanced Emissions Suppression Technology in the TPA3111D1 amplifier it is possible to design a high efficiency, Class-D audio amplifier while minimizing interference to surrounding circuits. It is also possible to accomplish this with only a low-cost ferrite bead filter. Carefully select the ferrite bead used in the filter.

One important aspect of the ferrite bead selection is the type of material used in the ferrite bead. Not all ferrite material is alike, so it is important to select a material that is effective in the 10 MHz to 100 MHz range which is key to the operation of the Class-D amplifier. Many of the specifications regulating consumer electronics have emissions limits as low as 30 MHz. It is important to use the ferrite bead filter to block radiation in the 30 MHz and above range from appearing on the speaker wires and the power supply lines which are good antennas for these signals. The impedance of the ferrite bead can be used along with a small capacitor, approximately 1000 pF, to reduce the frequency spectrum of the signal to an acceptable level. For best performance, the resonant frequency of the ferrite bead and capacitor filter must be less than 10 MHz.

The ferrite bead must be large enough to maintain its impedance at the peak currents expected for the amplifier. Some ferrite bead manufacturers specify the bead impedance at a variety of current levels. It is possible to make sure the ferrite bead maintains an adequate amount of impedance at the peak current the amplifier receives. If these specifications are not available, it is also possible to estimate the bead current handling capability by measuring the resonant frequency of the filter output at very low power and at maximum power. A change of resonant frequency of less than 50% under this condition is desirable.

A high-quality ceramic capacitor is also required for the ferrite bead filter. A low-ESR capacitor with good temperature and voltage characteristics works best.

Additional EMC improvements may be obtained by adding snubber networks from each of the Class-D outputs to ground. Suggested values for a simple RC series snubber network would be 10 Ω in series with a 330-pF capacitor. However, design of the snubber network is specific to every application and the design must take into account the parasitic reactance of the printed-circuit board as well as the audio amp. Evaluate the stress on the component in the snubber network, especially if the amp is running at high PVCC. Also, make sure the layout of the snubber network is tight and returns directly to the PGND or the PowerPad beneath the chip.

8.2.2.2 Efficiency: LC Filter Required With the Traditional Class-D Modulation Scheme

The main reason that the traditional Class-D amplifier requires an output filter is that the switching waveform results in maximum current flow. This causes more loss in the load, which causes lower efficiency. The ripple current is large for the traditional modulation scheme, because the ripple current is proportional to voltage multiplied by the time at that voltage. The differential voltage swing is $2 \times V_{CC}$, and the time at each voltage is half the period for the traditional modulation scheme. An ideal LC filter is required to store the ripple current from each half cycle for the next half cycle, while any resistance causes power dissipation. The speaker is both resistive and reactive, whereas an LC filter is almost purely reactive.

The TPA3111D1 modulation scheme has little loss in the load without a filter because the pulses are short and the change in voltage is V_{CC} instead of $2 \times V_{CC}$. As the output power increases, the pulses widen, making the ripple current larger. Ripple current could be filtered with an LC filter for increased efficiency, but for most applications the filter is not required.

An LC filter with a cutoff frequency less than the Class-D switching frequency allows the switching current to flow through the filter instead of the load. The filter has less resistance but higher impedance at the switching frequency than the speaker, which results in less power dissipation, therefore increasing efficiency.

8.2.2.3 When to Use an Output Filter for EMI Suppression

The TPA3111D1 has been tested with a simple ferrite bead filter for a variety of applications including long speaker wires up to 125 cm and high power. The TPA3111D1EVM passes FCC Class-B specifications under these conditions using twisted speaker wires. The size and type of ferrite bead can be selected to meet application requirements. The filter capacitor can also be increased if necessary with some impact on efficiency.

There may be a few circuit instances where it is necessary to add a complete LC reconstruction filter. These circumstances might occur if there are nearby circuits which are very sensitive to noise. In these cases a classic second order Butterworth filter similar to those shown in Figure 18, Figure 19, and Figure 20 can be used.

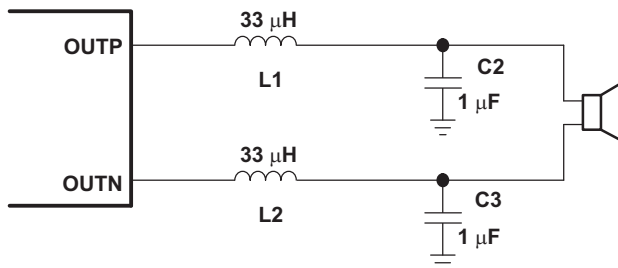

Figure 18. Typical LC Output Filter, Cutoff Frequency of 27 kHz, Speaker Impedance = 8 Ω

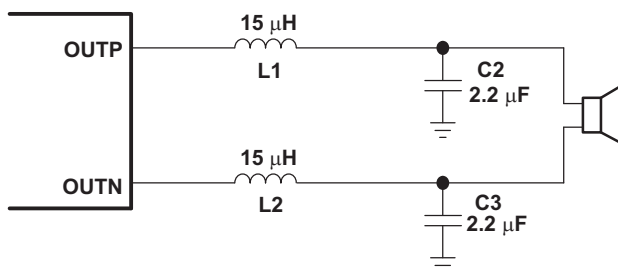

Figure 19. Typical LC Output Filter, Cutoff Frequency of 27 kHz, Speaker Impedance = 4 Ω

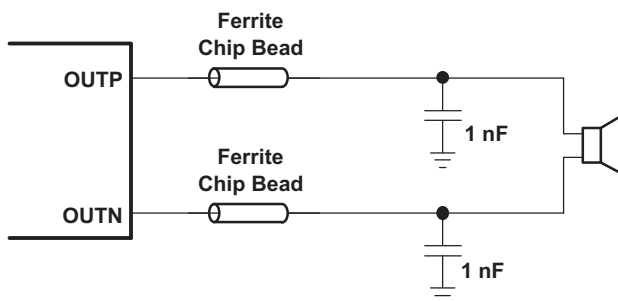
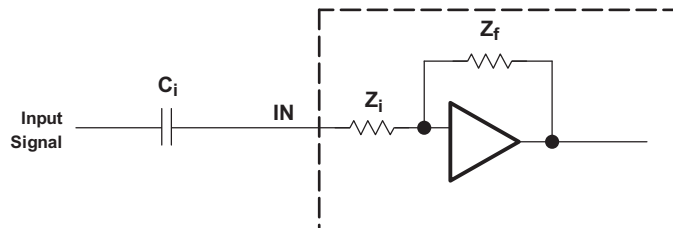

Figure 20. Typical Ferrite Chip Bead Filter

8.2.2.4 Input Resistance

Changing the gain setting can vary the input resistance of the amplifier from its smallest value, $9\text{ k}\Omega \pm 20\%$, to the largest value, $60\text{ k}\Omega \pm 20\%$. As a result, if a single capacitor is used in the input high-pass filter, the -3-dB or cutoff frequency may change when changing gain steps.



The -3-dB frequency can be calculated using Equation 2. Use the Z_i values given in Table 1.

$$f = \frac{1}{2\pi Z_i C_i} \quad (2)$$

8.2.2.5 Input Capacitor, C_i

In the typical application, an input capacitor (C_i) is required to allow the amplifier to bias the input signal to the proper DC level for optimum operation. In this case, C_i and the input impedance of the amplifier (Z_i) form a high-pass filter with the corner frequency determined in Equation 3.

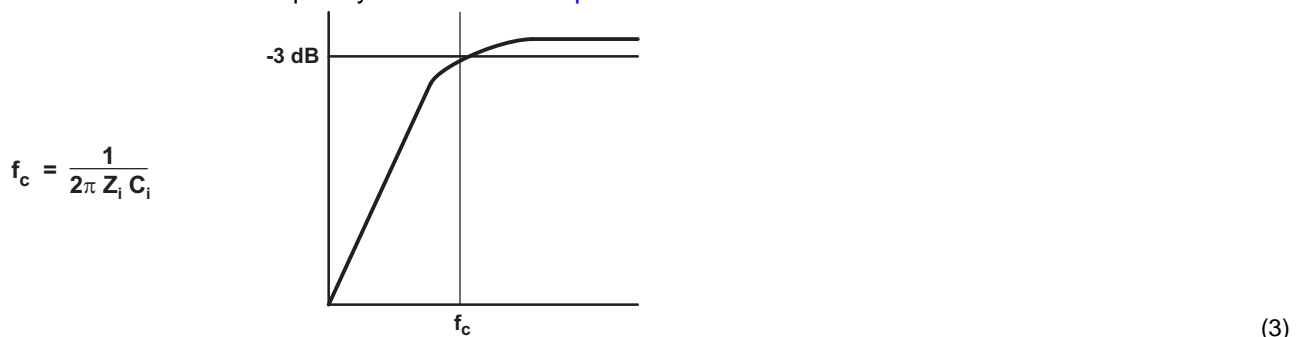

$$f_c = \frac{1}{2\pi Z_i C_i} \quad (3)$$

The value of C_i is important, as it directly affects the bass (low-frequency) performance of the circuit. Consider the example where Z_i is $60\text{ k}\Omega$ and the specification calls for a flat bass response down to 20 Hz . Equation 3 is reconfigured as Equation 4.

$$C_i = \frac{1}{2\pi Z_i f_c} \quad (4)$$

In this example, C_i is $0.13\text{ }\mu\text{F}$; so, a value of $0.15\text{ }\mu\text{F}$ would likely be chosen. If the gain is known and is constant, use Z_i from Table 1 to calculate C_i . A further consideration for this capacitor is the leakage path from the input source through the input network (C_i) and the feedback network to the load. This leakage current creates a DC-offset voltage at the input to the amplifier that reduces useful headroom, especially in high-gain applications. For this reason, a low-leakage tantalum or ceramic capacitor is the best choice. If a ceramic capacitor is used, use a high-quality capacitor with good temperature and voltage coefficient. An X7R type works well and if possible use a higher voltage rating than required. This gives a better capacitance versus voltage characteristic. When polarized capacitors are used, the positive side of the capacitor must face the amplifier input in most applications as the DC level there is held at 3 V , which is likely higher than the source DC level. It is important to confirm the capacitor polarity in the application. Additionally, lead-free solder can create DC-offset voltages and it is important to ensure that boards are cleaned properly.

8.2.2.6 BSN and BSP Capacitors

The full H-bridge output stage uses only NMOS transistors. Therefore, they require bootstrap capacitors for the high side of each output to turn on correctly. A 470-nF ceramic capacitor, rated for at least 16 V, must be connected from each output to its corresponding bootstrap input. Specifically, one 470-nF capacitor must be connected from OUTP to BSP, and one 470-nF capacitor must be connected from OUTN to BSN. See [Simplified Application Diagram](#).

The bootstrap capacitors connected between the BSx pins and corresponding output function as a floating power supply for the high-side N-channel power MOSFET gate drive circuitry. During each high-side switching cycle, the bootstrap capacitors hold the gate-to-source voltage high enough to keep the high-side MOSFETs turned on.

8.2.2.7 Differential Inputs

The differential input stage of the amplifier cancels any noise that appears on both input lines of the channel. To use the TPA3111D1 with a differential source, connect the positive lead of the audio source to the INP input and the negative lead from the audio source to the INN input. To use the TPA3111D1 with a single-ended source, AC ground the INP or INN input through a capacitor equal in value to the input capacitor on INN or INP and apply the audio source to either input. In a single-ended input application, the unused input must be AC grounded at the audio source instead of at the device input for best noise performance. For good transient performance, the impedance at each of the two differential inputs must be the same.

The impedance at the inputs must be limited to an RC time constant of 1 ms or less if possible. This is to allow the input DC-blocking capacitors to become completely charged during the 14-ms power-up time. If the input capacitors are not allowed to completely charge, there is some additional sensitivity to component matching which can result in pop if the input components are not well matched.

8.2.2.8 Using Low-ESR Capacitors

A real, as opposed to ideal, capacitor can be modeled simply as a resistor in series with an ideal capacitor. The voltage drop across this resistor minimizes the beneficial effects of the capacitor in the circuit. The lower the equivalent value of this resistance, the more the real capacitor behaves like an ideal capacitor.

8.2.3 Application Curves

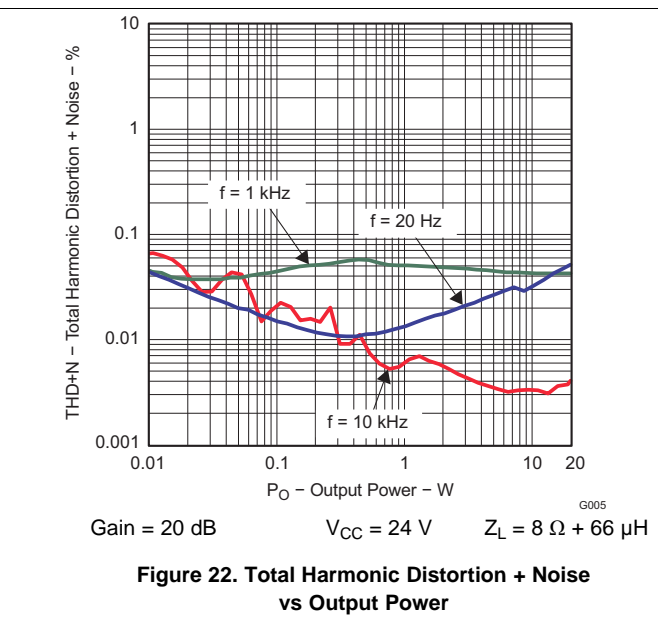
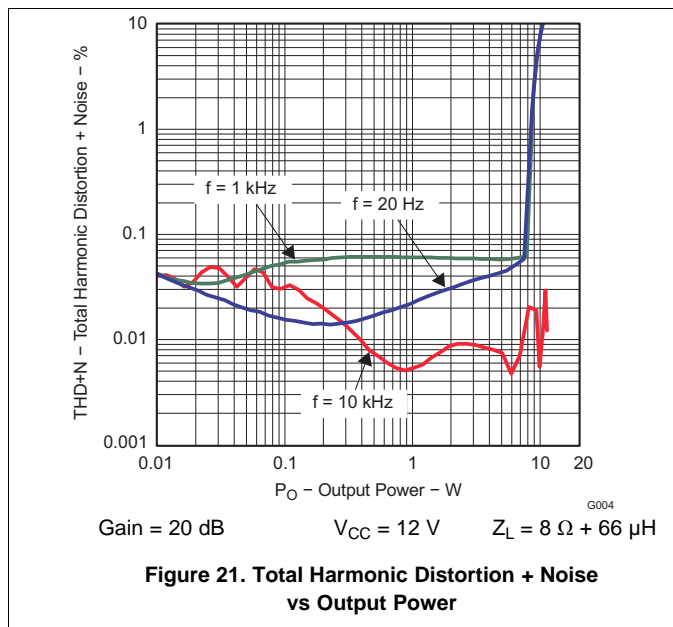

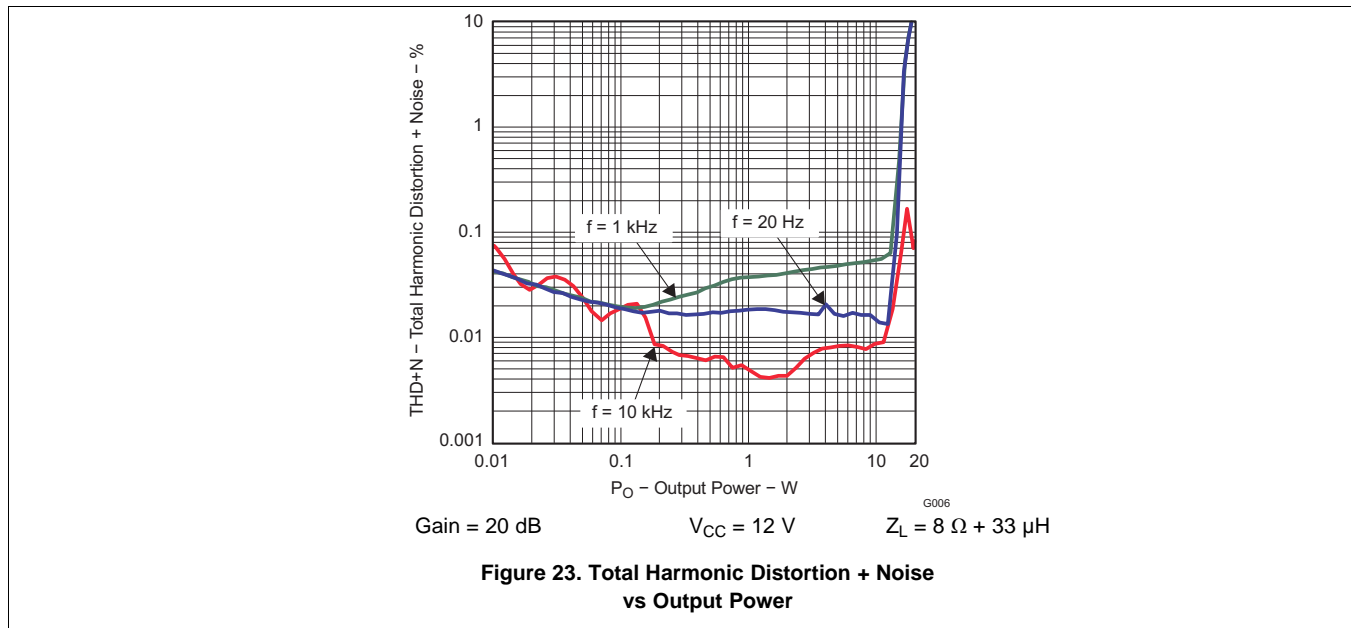

9 Power Supply Recommendations

The TPA3111D1 is a high-performance CMOS audio amplifier that requires adequate power supply decoupling to ensure that the output total harmonic distortion (THD) is as low as possible. Power supply decoupling also prevents oscillations for long lead lengths between the amplifier and the speaker.

Optimum decoupling is achieved by using a network of capacitors of different types that target specific types of noise on the power supply leads. For higher frequency transients due to parasitic circuit elements such as bond wire and copper trace inductances as well as lead frame capacitance, a good-quality, low equivalent-series-resistance (ESR) ceramic capacitor from 220 pF to 1000 pF works well. This capacitor must be placed as close to the device PVCC pins and system ground (either PGND pins or PowerPad) as possible. For mid-frequency noise due to filter resonances or PWM switching transients as well as digital hash on the line, another good-quality capacitor typically 0.1 μF to 1 μF placed as close as possible to the device PVCC leads works best. For filtering lower frequency noise signals, a larger aluminum electrolytic capacitor of 220 μF or greater placed near the audio power amplifier works well. The 220-μF capacitor also serves as a local storage capacitor for supplying current during large signal transients on the amplifier outputs. The PVCC pins provide the power to the output transistors, so a 220-μF or larger capacitor must be placed on each PVCC pin. A 10-μF capacitor on the AVCC pin is adequate. Also, a small decoupling resistor between AVCC and PVCC can be used to keep high frequency, Class-D noise from entering the linear input amplifiers.

10 Layout

10.1 Layout Guidelines

The TPA3111D1 can be used with a small, inexpensive ferrite bead output filter for most applications. However, because the Class-D switching edges are very fast, take care when planning the layout of the printed-circuit board. The following suggestions help to meet EMC requirements.

- **Decoupling capacitors:** The high-frequency decoupling capacitors must be placed as close to the PVCC and AVCC pins as possible. Large, 220- μ F or greater, bulk power supply decoupling capacitors must be placed near the TPA3111D1 on the PVCC supplies. Local, high-frequency bypass capacitors must be placed as close to the PVCC pins as possible. These capacitors can be connected to the thermal pad directly for an excellent ground connection. Consider adding a small, good-quality, low-ESR ceramic capacitor from 220 pF to 1000 pF and a larger mid-frequency capacitor from 0.1 μ F to 1 μ F also of good quality to the PVCC connections at each end of the chip.
- **Keep the current loop** from each of the outputs through the ferrite bead and the small filter capacitor and back to PGND as small and tight as possible. The size of this current loop determines its effectiveness as an antenna.
- **Output filter:** The ferrite EMI filter ([Figure 20](#)) must be placed as close to the output pins as possible for the best EMI performance. The LC filter ([Figure 18](#) and [Figure 19](#)) must be placed close to the outputs. The capacitors used in both the ferrite and LC filters must be grounded to power ground.
- **Thermal Pad:** The thermal pad must be soldered to the PCB for proper thermal performance and optimal reliability. The dimensions of the thermal pad and thermal land must be 6.46 mm by 2.35 mm. Seven rows of solid vias, three vias per row, 0.33-mm or 13-mils diameter, must be equally spaced underneath the thermal land. The vias must connect to a solid copper plane, either on an internal layer or on the bottom layer of the PCB. The vias must be solid vias, not thermal relief or webbed vias. See [PowerPad™ Thermally Enhanced package](#) (SLMA002) for more information about using the HTSSOP thermal pad. For recommended PCB footprints, see mechanical pages appended to the end of this data sheet.

For an example layout, see the [TPA3111D1EVM Audio Amplifier Evaluation Board User's Guide](#) (SLOU270). The EVM documentation is available on the TI website at <http://www.ti.com/tool/TPA3111D1EVM>.

10.2 Layout Example

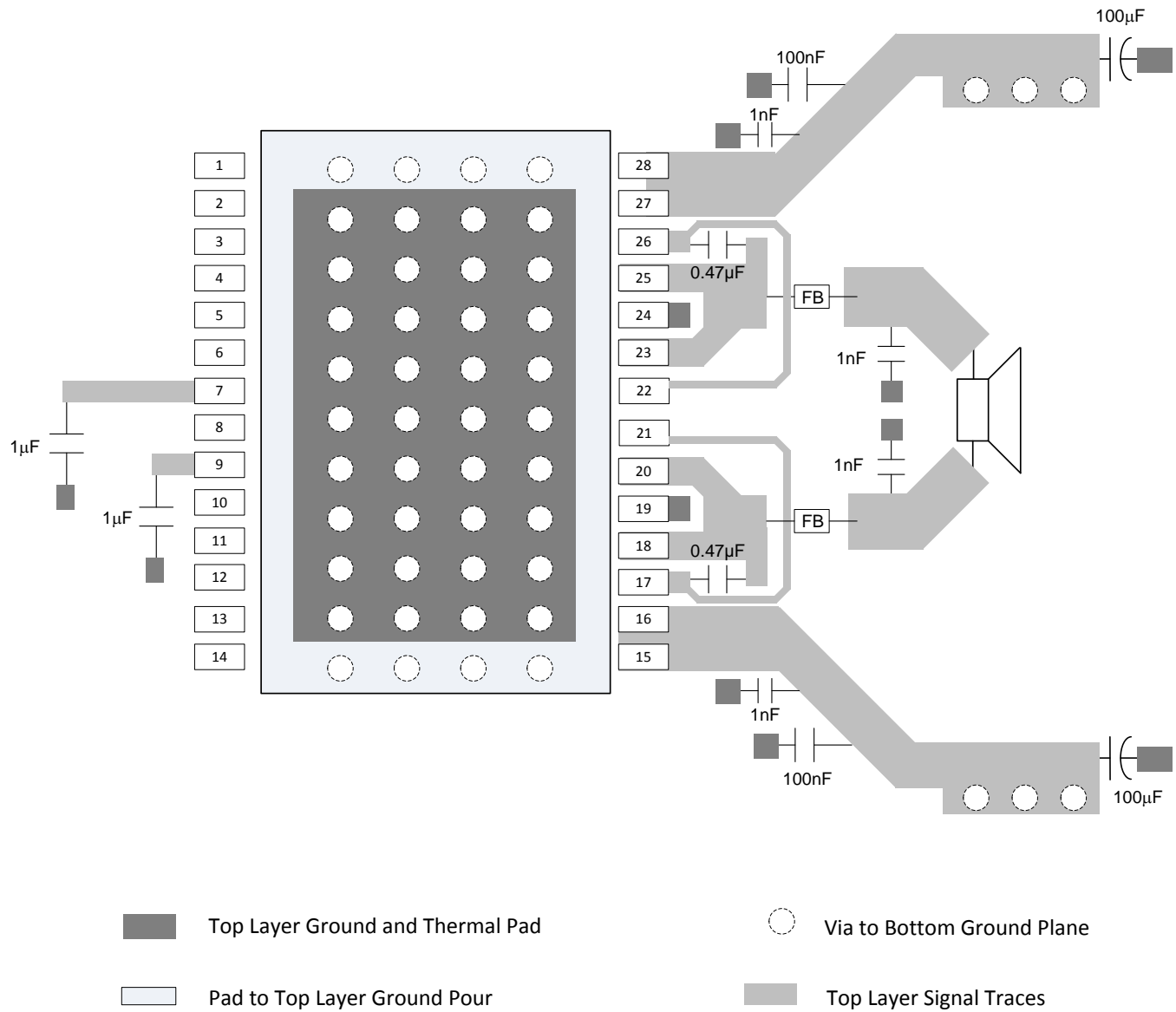

Figure 24. BTL Layout Example

11 Device and Documentation Support

11.1 Device Support

11.1.1 Development Support

For development support, see the following:

- [TI PCB Thermal Calculator](#)
- [TPA3111D1EVM](#)

11.2 Documentation Support

11.2.1 Related Documentation

For related documentation see the following:

- [Quad Flatpack No-Lead Logic Packages](#) (SCBA017)
- [QFN/SON PCB Attachment](#) (SLUA271)
- [PowerPad™ Thermally Enhanced package](#) (SLMA002)
- [TPA3111D1EVM Audio Amplifier Evaluation Board User's Guide](#) (SLOU270)

11.3 Receiving Notification of Documentation Updates

To receive notification of documentation updates, navigate to the device product folder on ti.com. In the upper right corner, click on *Alert me* to register and receive a weekly digest of any product information that has changed. For change details, review the revision history included in any revised document.

11.4 Community Resources

The following links connect to TI community resources. Linked contents are provided "AS IS" by the respective contributors. They do not constitute TI specifications and do not necessarily reflect TI's views; see TI's [Terms of Use](#).

TI E2E™ Online Community *TI's Engineer-to-Engineer (E2E) Community*. Created to foster collaboration among engineers. At e2e.ti.com, you can ask questions, share knowledge, explore ideas and help solve problems with fellow engineers.

Design Support *TI's Design Support* Quickly find helpful E2E forums along with design support tools and contact information for technical support.

11.5 Trademarks

SpeakerGuard, E2E are trademarks of Texas Instruments.
All other trademarks are the property of their respective owners.

11.6 Electrostatic Discharge Caution



These devices have limited built-in ESD protection. The leads should be shorted together or the device placed in conductive foam during storage or handling to prevent electrostatic damage to the MOS gates.

11.7 Glossary

[SLYZ022](#) — *TI Glossary*.

This glossary lists and explains terms, acronyms, and definitions.

12 Mechanical, Packaging, and Orderable Information

The following pages include mechanical, packaging, and orderable information. This information is the most current data available for the designated devices. This data is subject to change without notice and revision of this document. For browser-based versions of this data sheet, refer to the left-hand navigation.

PACKAGING INFORMATION

Orderable Device	Status (1)	Package Type	Package Drawing	Pins	Package Qty	Eco Plan (2)	Lead finish/ Ball material (6)	MSL Peak Temp (3)	Op Temp (°C)	Device Marking (4/5)	Samples
TPA3111D1PWP	ACTIVE	HTSSOP	PWP	28	50	RoHS & Green	NIPDAU	Level-3-260C-168 HR	-40 to 85	TPA3111D1	Samples
TPA3111D1PWPR	ACTIVE	HTSSOP	PWP	28	2000	RoHS & Green	NIPDAU	Level-3-260C-168 HR	-40 to 85	TPA3111D1	Samples

(1) The marketing status values are defined as follows:

ACTIVE: Product device recommended for new designs.

LIFEBUY: TI has announced that the device will be discontinued, and a lifetime-buy period is in effect.

NRND: Not recommended for new designs. Device is in production to support existing customers, but TI does not recommend using this part in a new design.

PREVIEW: Device has been announced but is not in production. Samples may or may not be available.

OBSELETE: TI has discontinued the production of the device.

(2) **RoHS:** TI defines "RoHS" to mean semiconductor products that are compliant with the current EU RoHS requirements for all 10 RoHS substances, including the requirement that RoHS substance do not exceed 0.1% by weight in homogeneous materials. Where designed to be soldered at high temperatures, "RoHS" products are suitable for use in specified lead-free processes. TI may reference these types of products as "Pb-Free".

RoHS Exempt: TI defines "RoHS Exempt" to mean products that contain lead but are compliant with EU RoHS pursuant to a specific EU RoHS exemption.

Green: TI defines "Green" to mean the content of Chlorine (Cl) and Bromine (Br) based flame retardants meet JS709B low halogen requirements of <=1000ppm threshold. Antimony trioxide based flame retardants must also meet the <=1000ppm threshold requirement.

(3) MSL, Peak Temp. - The Moisture Sensitivity Level rating according to the JEDEC industry standard classifications, and peak solder temperature.

(4) There may be additional marking, which relates to the logo, the lot trace code information, or the environmental category on the device.

(5) Multiple Device Markings will be inside parentheses. Only one Device Marking contained in parentheses and separated by a "~" will appear on a device. If a line is indented then it is a continuation of the previous line and the two combined represent the entire Device Marking for that device.

(6) Lead finish/Ball material - Orderable Devices may have multiple material finish options. Finish options are separated by a vertical ruled line. Lead finish/Ball material values may wrap to two lines if the finish value exceeds the maximum column width.

Important Information and Disclaimer:The information provided on this page represents TI's knowledge and belief as of the date that it is provided. TI bases its knowledge and belief on information provided by third parties, and makes no representation or warranty as to the accuracy of such information. Efforts are underway to better integrate information from third parties. TI has taken and continues to take reasonable steps to provide representative and accurate information but may not have conducted destructive testing or chemical analysis on incoming materials and chemicals. TI and TI suppliers consider certain information to be proprietary, and thus CAS numbers and other limited information may not be available for release.

In no event shall TI's liability arising out of such information exceed the total purchase price of the TI part(s) at issue in this document sold by TI to Customer on an annual basis.

OTHER QUALIFIED VERSIONS OF TPA3111D1 :

- Automotive: [TPA3111D1-Q1](#)

NOTE: Qualified Version Definitions:

- Automotive - Q100 devices qualified for high-reliability automotive applications targeting zero defects

TAPE AND REEL INFORMATION



QUADRANT ASSIGNMENTS FOR PIN 1 ORIENTATION IN TAPE



*All dimensions are nominal

Device	Package Type	Package Drawing	Pins	SPQ	Reel Diameter (mm)	Reel Width W1 (mm)	A0 (mm)	B0 (mm)	K0 (mm)	P1 (mm)	W (mm)	Pin1 Quadrant
TPA3111D1PWPR	HTSSOP	PWP	28	2000	330.0	16.4	6.9	10.2	1.8	12.0	16.0	Q1

TAPE AND REEL BOX DIMENSIONS



*All dimensions are nominal

Device	Package Type	Package Drawing	Pins	SPQ	Length (mm)	Width (mm)	Height (mm)
TPA3111D1PWPR	HTSSOP	PWP	28	2000	350.0	350.0	43.0

GENERIC PACKAGE VIEW

PWP 28

PowerPAD™ TSSOP - 1.2 mm max height

4.4 x 9.7, 0.65 mm pitch

SMALL OUTLINE PACKAGE

This image is a representation of the package family, actual package may vary.
Refer to the product data sheet for package details.

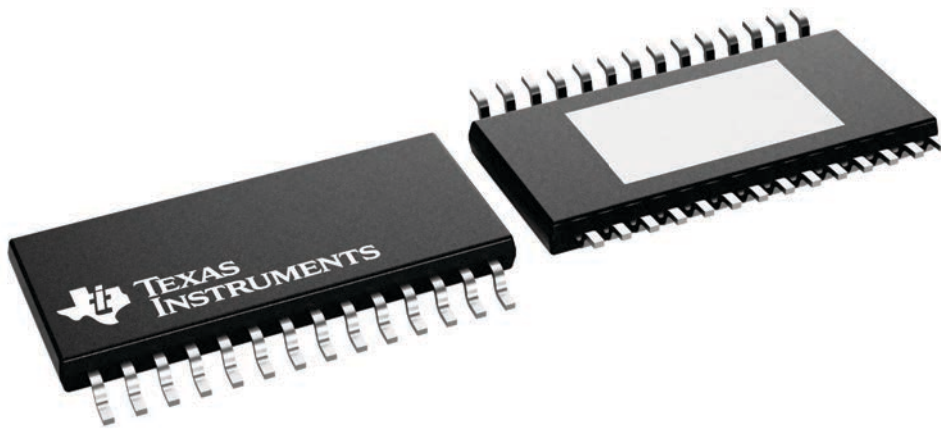

4224765/B

MECHANICAL DATA

PWP (R-PDSO-G28)

PowerPAD™ PLASTIC SMALL OUTLINE

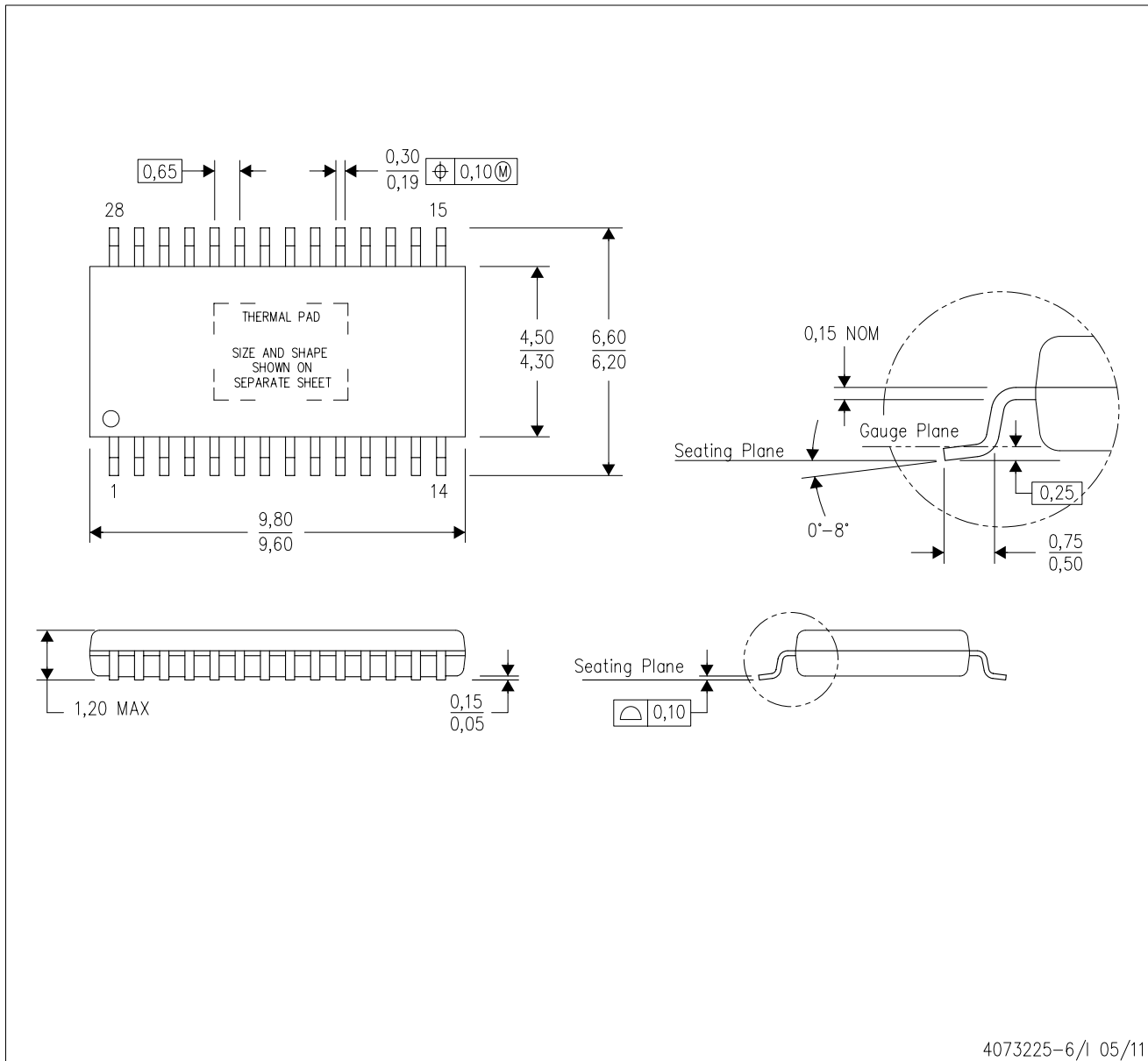

- NOTES:
- All linear dimensions are in millimeters.
 - This drawing is subject to change without notice.
 - Body dimensions do not include mold flash or protrusions. Mold flash and protrusion shall not exceed 0.15 per side.
 - This package is designed to be soldered to a thermal pad on the board. Refer to Technical Brief, PowerPad Thermally Enhanced Package, Texas Instruments Literature No. SLMA002 for information regarding recommended board layout. This document is available at www.ti.com <<http://www.ti.com>>.
 - See the additional figure in the Product Data Sheet for details regarding the exposed thermal pad features and dimensions.
 - Falls within JEDEC MO-153

PowerPAD is a trademark of Texas Instruments.

THERMAL PAD MECHANICAL DATA

PWP (R-PDSO-G28) PowerPAD™ SMALL PLASTIC OUTLINE

THERMAL INFORMATION

This PowerPAD™ package incorporates an exposed thermal pad that is designed to be attached to a printed circuit board (PCB). The thermal pad must be soldered directly to the PCB. After soldering, the PCB can be used as a heatsink. In addition, through the use of thermal vias, the thermal pad can be attached directly to the appropriate copper plane shown in the electrical schematic for the device, or alternatively, can be attached to a special heatsink structure designed into the PCB. This design optimizes the heat transfer from the integrated circuit (IC).

For additional information on the PowerPAD package and how to take advantage of its heat dissipating abilities, refer to Technical Brief, PowerPAD Thermally Enhanced Package, Texas Instruments Literature No. SLMA002 and Application Brief, PowerPAD Made Easy, Texas Instruments Literature No. SLMA004. Both documents are available at www.ti.com.

The exposed thermal pad dimensions for this package are shown in the following illustration.

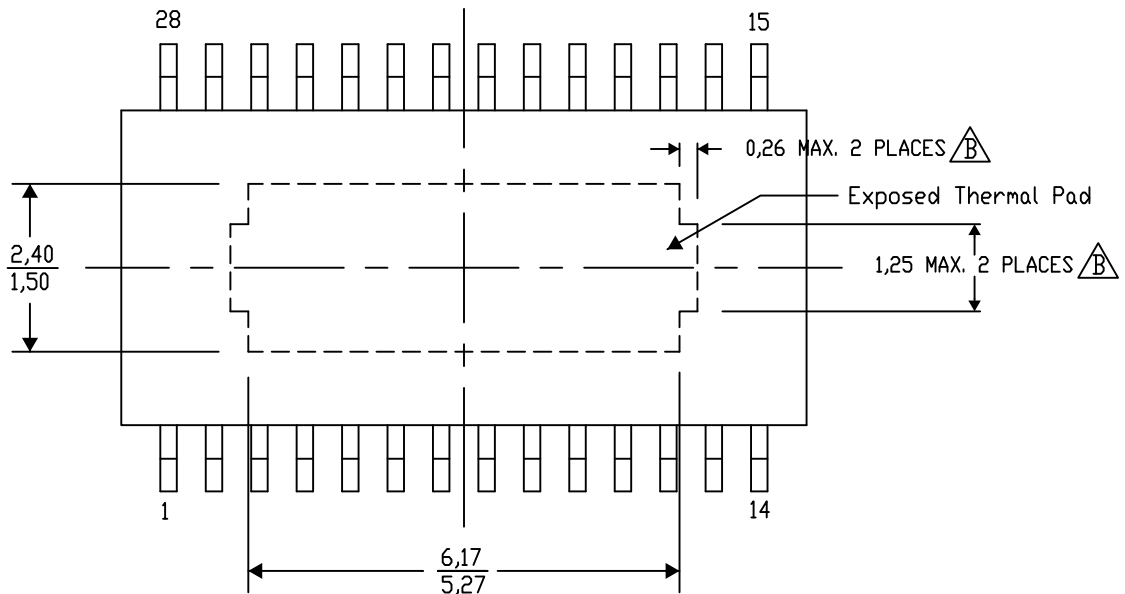

Top View

Exposed Thermal Pad Dimensions

4206332-33/AO 01/16

NOTE: A. All linear dimensions are in millimeters
 $\triangle B$. Exposed tie strap features may not be present.

PowerPAD is a trademark of Texas Instruments

PWP (R-PDSO-G28)

PowerPAD™ PLASTIC SMALL OUTLINE

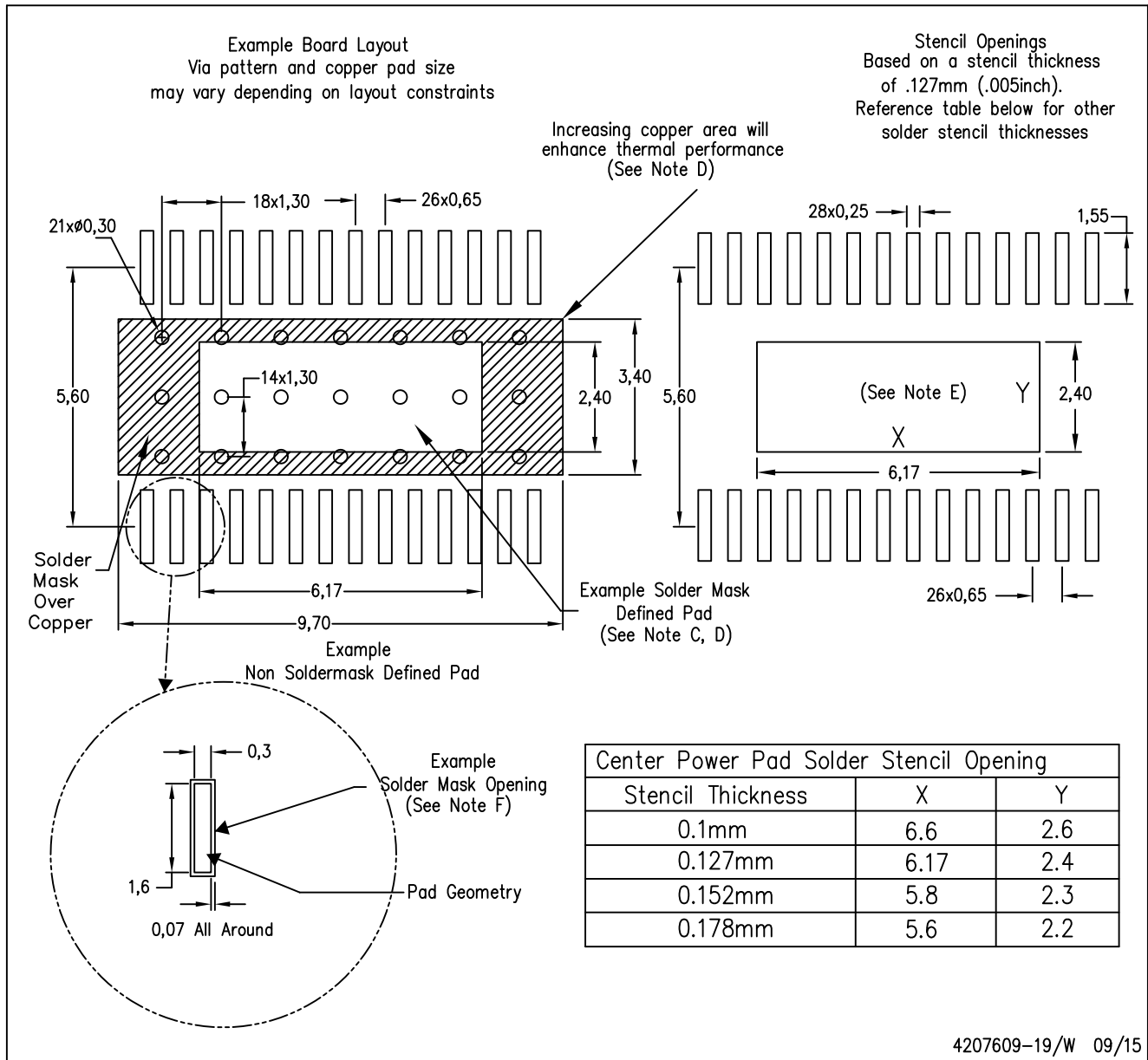

- NOTES:
- All linear dimensions are in millimeters.
 - This drawing is subject to change without notice.
 - Customers should place a note on the circuit board fabrication drawing not to alter the center solder mask defined pad.
 - This package is designed to be soldered to a thermal pad on the board. Refer to Technical Brief, PowerPad Thermally Enhanced Package, Texas Instruments Literature No. SLMA002, SLMA004, and also the Product Data Sheets.
 - For specific thermal information, via requirements, and recommended board layout. These documents are available at www.ti.com <<http://www.ti.com>>. Publication IPC-7351 is recommended for alternate designs. Laser cutting apertures with trapezoidal walls and also rounding corners will offer better paste release. Customers should contact their board assembly site for stencil design recommendations. Example stencil design based on a 50% volumetric metal load solder paste. Refer to IPC-7525 for other stencil
 - Customers should contact their board fabrication site for solder mask tolerances between and around signal pads.

IMPORTANT NOTICE AND DISCLAIMER

TI PROVIDES TECHNICAL AND RELIABILITY DATA (INCLUDING DATASHEETS), DESIGN RESOURCES (INCLUDING REFERENCE DESIGNS), APPLICATION OR OTHER DESIGN ADVICE, WEB TOOLS, SAFETY INFORMATION, AND OTHER RESOURCES "AS IS" AND WITH ALL FAULTS, AND DISCLAIMS ALL WARRANTIES, EXPRESS AND IMPLIED, INCLUDING WITHOUT LIMITATION ANY IMPLIED WARRANTIES OF MERCHANTABILITY, FITNESS FOR A PARTICULAR PURPOSE OR NON-INFRINGEMENT OF THIRD PARTY INTELLECTUAL PROPERTY RIGHTS.

These resources are intended for skilled developers designing with TI products. You are solely responsible for (1) selecting the appropriate TI products for your application, (2) designing, validating and testing your application, and (3) ensuring your application meets applicable standards, and any other safety, security, or other requirements. These resources are subject to change without notice. TI grants you permission to use these resources only for development of an application that uses the TI products described in the resource. Other reproduction and display of these resources is prohibited. No license is granted to any other TI intellectual property right or to any third party intellectual property right. TI disclaims responsibility for, and you will fully indemnify TI and its representatives against, any claims, damages, costs, losses, and liabilities arising out of your use of these resources.

TI's products are provided subject to TI's Terms of Sale (www.ti.com/legal/termsofsale.html) or other applicable terms available either on ti.com or provided in conjunction with such TI products. TI's provision of these resources does not expand or otherwise alter TI's applicable warranties or warranty disclaimers for TI products.

Mailing Address: Texas Instruments, Post Office Box 655303, Dallas, Texas 75265
Copyright © 2020, Texas Instruments Incorporated

单击下面可查看定价，库存，交付和生命周期等信息

[>>TI\(德州仪器\)](#)