

## CSD18531Q5A 60-V N-Channel NexFET™ Power MOSFET

### 1 Features

- Ultra-Low  $Q_g$  and  $Q_{gd}$
- Low-Thermal Resistance
- Avalanche Rated
- Logic Level
- Lead-Free Terminal Plating
- RoHS Compliant
- Halogen Free
- SON 5-mm × 6-mm Plastic Package

### 2 Applications

- DC-DC Conversion
- Secondary Side Synchronous Rectifier
- Battery Motor Control

### 3 Description

This 60-V, 3.5-m $\Omega$ , 5-mm × 6-mm NexFET™ power MOSFET is designed to minimize losses in power conversion applications.

Top View

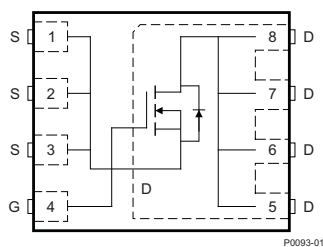

P0093-01

### Product Summary

$T_A = 25^\circ\text{C}$		TYPICAL VALUE		UNIT
$V_{DS}$	Drain-to-Source Voltage	60		V
$Q_g$	Gate Charge Total (10 V)	36		nC
$Q_{gd}$	Gate Charge Gate-to-Drain	5.9		nC
$R_{DS(on)}$	Drain-to-Source On-Resistance	$V_{GS} = 4.5\text{ V}$	4.4	m $\Omega$
		$V_{GS} = 10\text{ V}$	3.5	
$V_{GS(th)}$	Threshold Voltage	1.8		V

### Device Information<sup>(1)</sup>

DEVICE	QTY	MEDIA	PACKAGE	SHIP
CSD18531Q5A	2500	13-Inch Reel	SON	Tape and Reel
CSD18531Q5AT	250	7-Inch Reel	5.00-mm × 6.00-mm Plastic Package	Tape and Reel

(1) For all available packages, see the orderable addendum at the end of the data sheet.

### Absolute Maximum Ratings

$T_A = 25^\circ\text{C}$		VALUE	UNIT
$V_{DS}$	Drain-to-Source Voltage	60	V
$V_{GS}$	Gate-to-Source Voltage	$\pm 20$	V
$I_D$	Continuous Drain Current (Package Limited)	100	A
	Continuous Drain Current (Silicon Limited), $T_C = 25^\circ\text{C}$	134	
	Continuous Drain Current <sup>(1)</sup>	19	
$I_{DM}$	Pulsed Drain Current <sup>(2)</sup>	400	A
$P_D$	Power Dissipation <sup>(1)</sup>	3.8	W
	Power Dissipation, $T_C = 25^\circ\text{C}$	156	
$T_J$	Operating Junction	-55 to 175	$^\circ\text{C}$
$T_{stg}$	Storage Temperature	-55 to 175	$^\circ\text{C}$
$E_{AS}$	Avalanche Energy, Single Pulse $I_D = 67\text{ A}$ , $L = 0.1\text{ mH}$ , $R_G = 25\ \Omega$	224	mJ

(1) Typical  $R_{\theta JA} = 40^\circ\text{C/W}$  on a 1-in<sup>2</sup>, 2-oz Cu pad on a 0.06-in thick FR4 PCB.

(2) Max  $R_{\theta JC} = 1^\circ\text{C/W}$ , pulse duration  $\leq 100\ \mu\text{s}$ , duty cycle  $\leq 1\%$ .

$R_{DS(on)}$  vs  $V_{GS}$

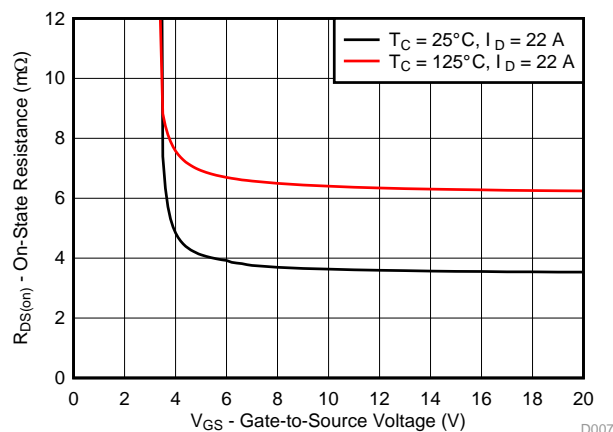

D007

Gate Charge

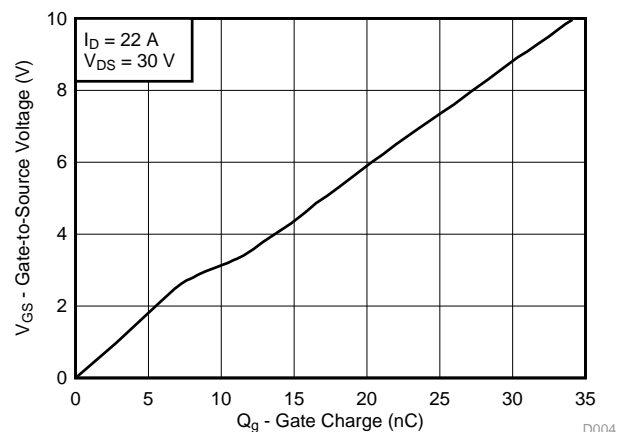

D004



## Table of Contents

<b>1 Features</b> ..... 1 <b>2 Applications</b> ..... 1 <b>3 Description</b> ..... 1 <b>4 Revision History</b> ..... 2 <b>5 Specifications</b> ..... 4 5.1 Electrical Characteristics..... 4 5.2 Thermal Information ..... 4 5.3 Typical MOSFET Characteristics..... 5 <b>6 Device and Documentation Support</b> ..... 8 6.1 Receiving Notification of Documentation Updates.... 8	6.2 Community Resources..... 8 6.3 Trademarks ..... 8 6.4 Electrostatic Discharge Caution ..... 8 6.5 Glossary ..... 8 <b>7 Mechanical Packaging, and Orderable Information</b> ..... 9 7.1 Q5A Package Dimensions ..... 9 7.2 Recommended PCB Pattern ..... 10 7.3 Recommended Stencil Opening ..... 10 7.4 Q5A Tape and Reel Information ..... 11
---	---

## 4 Revision History

NOTE: Page numbers for previous revisions may differ from page numbers in the current version.

<b>Changes from Revision F (October 2016) to Revision G</b>	<b>Page</b>
• Changed temperature range from 150°C : to 175°C.....	1
• Changed $I_{DM}$ using 175°C data from 370 A : to 400 A.....	1
• Changed $P_D$ using 175°C data from 3.1 W : to 3.8 W.....	1
• Changed <a href="#">Figure 6</a> to extend to 175°C.....	5
• Changed <a href="#">Figure 8</a> to extend to 175°C.....	6
• Changed <a href="#">Figure 10</a> using 175°C data.....	6
• Changed <a href="#">Figure 12</a> to extend to 175°C.....	6

<b>Changes from Revision E (August 2015) to Revision F</b>	<b>Page</b>
• Changed the 125°C $R_{DS(on)}$ vs $V_{GS}$ curve to reflect typical part characterization .....	1
• Changed the 125°C curve in <a href="#">Figure 7</a> to reflect typical part characterization.....	5
• Added <a href="#">Receiving Notification of Documentation Updates</a> section to the <i>Device and Documentation Support</i> section.....	8

<b>Changes from Revision D (May 2015) to Revision E</b>	<b>Page</b>
• Corrected device size in description from m to mm. ....	1
• Corrected package type to SON. ....	1

<b>Changes from Revision C (March 2015) to Revision D</b>	<b>Page</b>
• Added <a href="#">Community Resources</a> . ....	8

<b>Changes from Revision B (October 2012) to Revision C</b>	<b>Page</b>
• Added part number to title. ....	1
• Changed $Q_g$ value to 36 nC, measured at 10 V. ....	1
• Added 7" reel to Ordering Information. ....	1
• Increase max pulsed current to 370 A. ....	1
• Added line for max power dissipation with the case temperature held to 25°C.....	1
• Updated pulsed current conditions. ....	1
• Updated <a href="#">Figure 1</a> to show $Z_{\theta JC}$ curves. ....	5

• Updated <a href="#">Figure 10</a> .....	6
• Updated <a href="#">Figure 12</a> . ....	6

<b>Changes from Revision A (June 2012) to Revision B</b>	<b>Page</b>
--	-------------

• Changed the Transconductance TYP value From: 177 S To: 128 S.....	4
• Changed the Turn On and Turn Off Delay Time, Rise and Fall Time Test. Conditions From: $I_{DS} = 22\text{ A}$ , $R_G = 2\ \Omega$ To: $I_{DS} = 22\text{ A}$ , $R_G = 0\ \Omega$ . ....	4
• Changed the $Q_{rr}$ Reverse Recovery Charge TYP value From: 68 nC To: 100 nC. ....	4

<b>Changes from Original (June 2012) to Revision A</b>	<b>Page</b>
--	-------------

• Added $T_A = 25^\circ\text{C}$ to the Product Summary table .....	1
---	---

## 5 Specifications

### 5.1 Electrical Characteristics

 $T_A = 25^\circ\text{C}$  (unless otherwise stated)

PARAMETER		TEST CONDITIONS	MIN	TYP	MAX	UNIT	
<b>STATIC CHARACTERISTICS</b>							
$V_{DSS}$	Drain-to-source voltage	$V_{GS} = 0\text{ V}, I_D = 250\ \mu\text{A}$	60			V	
$I_{DSS}$	Drain-to-source leakage current	$V_{GS} = 0\text{ V}, V_{DS} = 48\text{ V}$			1	$\mu\text{A}$	
$I_{GSS}$	Gate-to-source leakage current	$V_{DS} = 0\text{ V}, V_{GS} = 20\text{ V}$			100	nA	
$V_{GS(th)}$	Gate-to-source threshold voltage	$V_{DS} = V_{GS}, I_D = 250\ \mu\text{A}$	1.5	1.8	2.3	V	
$R_{DS(on)}$	Drain-to-source on-resistance	$V_{GS} = 4.5\text{ V}, I_D = 22\text{ A}$		4.4	5.8	m $\Omega$	
		$V_{GS} = 10\text{ V}, I_D = 22\text{ A}$		3.5	4.6		
$g_{fs}$	Transconductance	$V_{DS} = 30\text{ V}, I_D = 22\text{ A}$		128		S	
<b>DYNAMIC CHARACTERISTICS</b>							
$C_{iss}$	Input capacitance	$V_{GS} = 0\text{ V}, V_{DS} = 30\text{ V}, f = 1\text{ MHz}$		3200	3840	pF	
$C_{oss}$	Output capacitance			380	456	pF	
$C_{rss}$	Reverse transfer capacitance			11	14	pF	
$R_G$	Series gate resistance			1.2	2.4	$\Omega$	
$Q_g$	Gate charge total (4.5 V)	$V_{DS} = 30\text{ V}, I_D = 22\text{ A}$		18	22	nC	
$Q_g$	Gate charge total (10 V)			36	43	nC	
$Q_{gd}$	Gate charge gate-to-drain			5.9		nC	
$Q_{gs}$	Gate charge gate-to-source			6.9		nC	
$Q_{g(th)}$	Gate charge at $V_{th}$			5.2		nC	
$Q_{oss}$	Output charge		$V_{DS} = 30\text{ V}, V_{GS} = 0\text{ V}$		32		nC
$t_{d(on)}$	Turnon delay time				4.4		ns
$t_r$	Rise time	$V_{DS} = 30\text{ V}, V_{GS} = 10\text{ V}, I_{DS} = 22\text{ A}, R_G = 0\ \Omega$		7.8		ns	
$t_{d(off)}$	Turnoff delay time			20		ns	
$t_f$	Fall time			2.7		ns	
<b>DIODE CHARACTERISTICS</b>							
$V_{SD}$	Diode forward voltage	$I_{SD} = 22\text{ A}, V_{GS} = 0\text{ V}$		0.8	1	V	
$Q_{rr}$	Reverse recovery charge	$V_{DS} = 30\text{ V}, I_F = 22\text{ A}, di/dt = 300\text{ A}/\mu\text{s}$		100		nC	
$t_{rr}$	Reverse recovery time			40		ns	

### 5.2 Thermal Information

 $T_A = 25^\circ\text{C}$  (unless otherwise stated)

THERMAL METRIC		MIN	TYP	MAX	UNIT
$R_{\theta JC}$	Junction-to-case thermal resistance <sup>(1)</sup>			1.0	$^\circ\text{C}/\text{W}$
$R_{\theta JA}$	Junction-to-ambient thermal resistance <sup>(1)(2)</sup>			50	$^\circ\text{C}/\text{W}$

- (1)  $R_{\theta JC}$  is determined with the device mounted on a 1-in<sup>2</sup> (6.45-cm<sup>2</sup>), 2-oz (0.071-mm) thick Cu pad on a 1.5-in × 1.5-in (3.81-cm × 3.81-cm), 0.06-in (1.52-mm) thick FR4 PCB.  $R_{\theta JC}$  is specified by design, whereas  $R_{\theta JA}$  is determined by the user's board design.
- (2) Device mounted on FR4 material with 1-in<sup>2</sup> (6.45-cm<sup>2</sup>), 2-oz (0.071-mm) thick Cu.

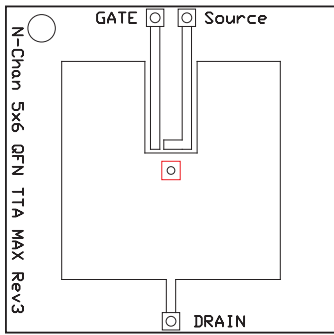

Max  $R_{\theta JA} = 50^{\circ}\text{C/W}$   
 when mounted on 1 in<sup>2</sup>  
 (6.45 cm<sup>2</sup>) of  
 2-oz (0.071-mm) thick  
 Cu.

M0137-01

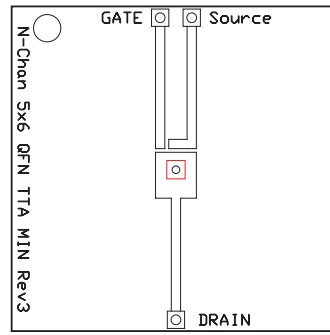

Max  $R_{\theta JA} = 125^{\circ}\text{C/W}$   
 when mounted on a  
 minimum pad area of  
 2-oz (0.071-mm) thick  
 Cu.

M0137-02

### 5.3 Typical MOSFET Characteristics

$T_A = 25^{\circ}\text{C}$  (unless otherwise stated)

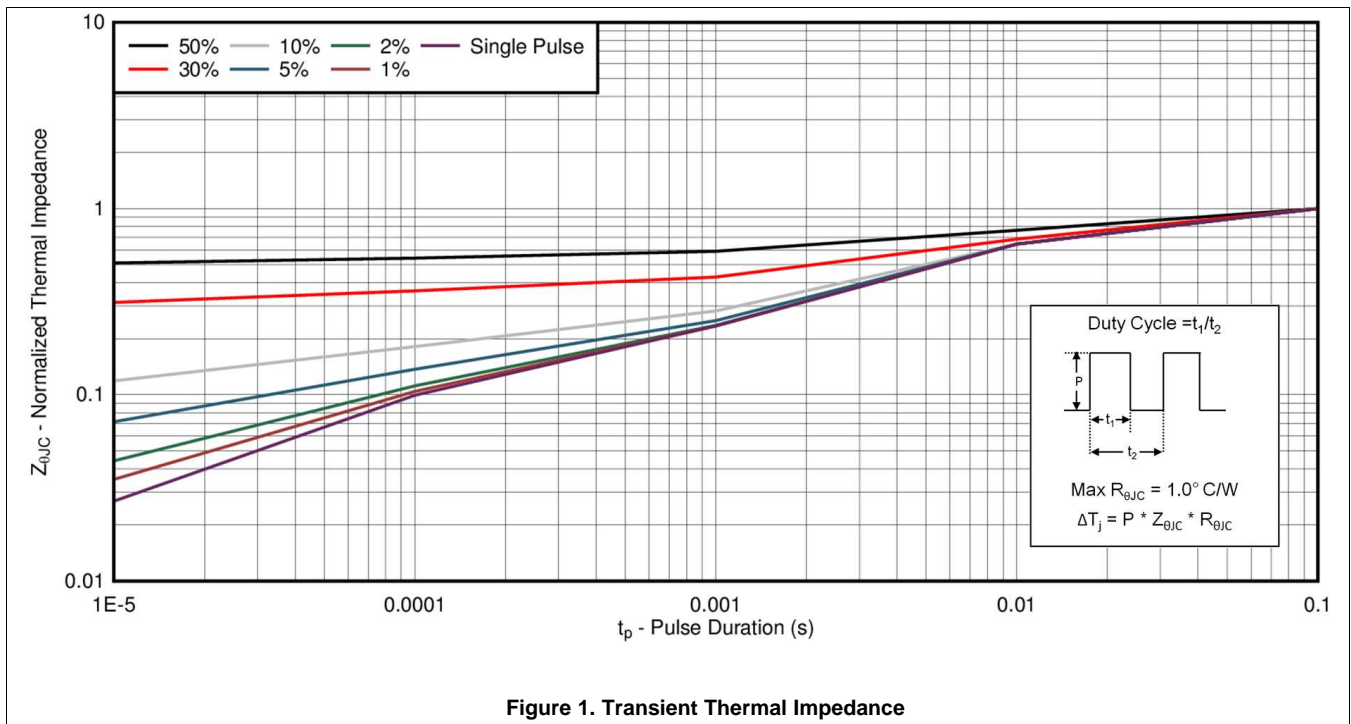

Typical MOSFET Characteristics (continued)

T<sub>A</sub> = 25°C (unless otherwise stated)

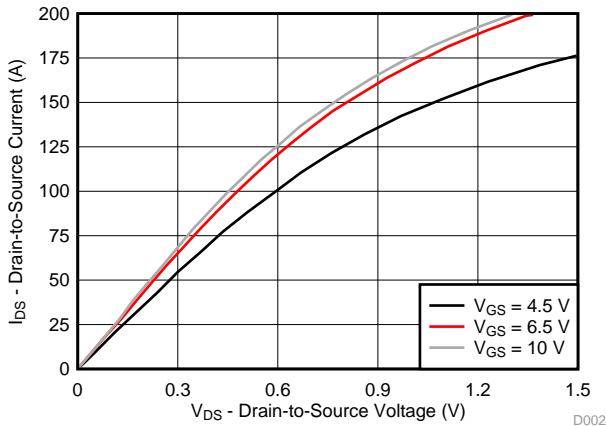

Figure 2. Saturation Characteristics

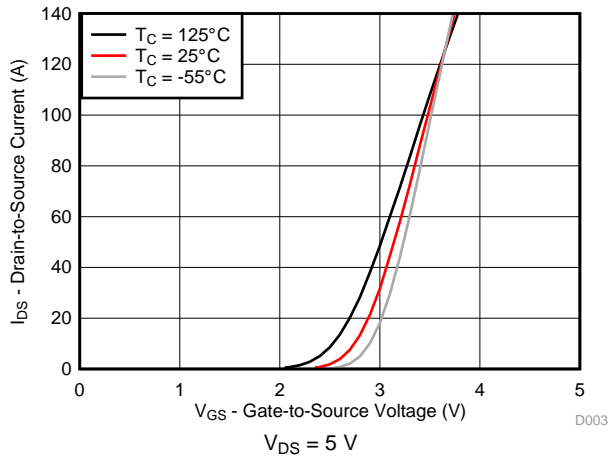

Figure 3. Transfer Characteristics

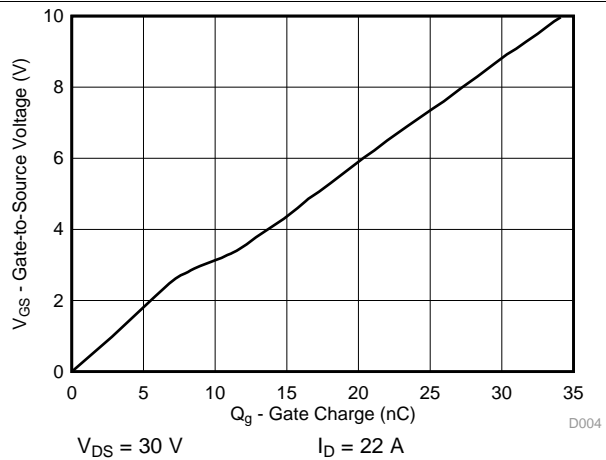

Figure 4. Gate Charge

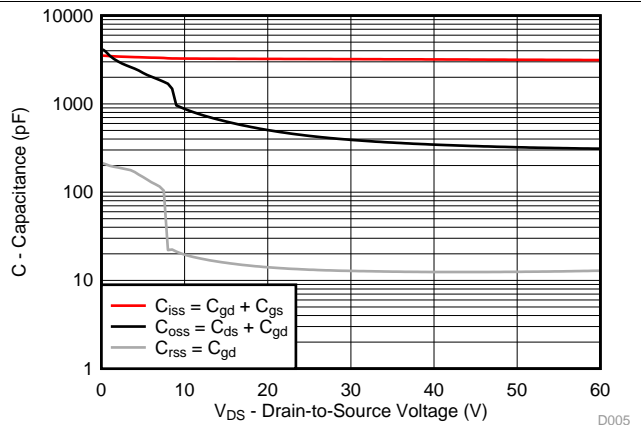

Figure 5. Capacitance

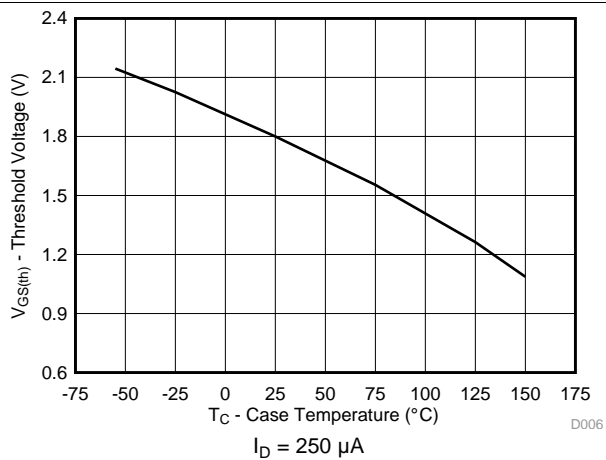

Figure 6. Threshold Voltage vs Temperature

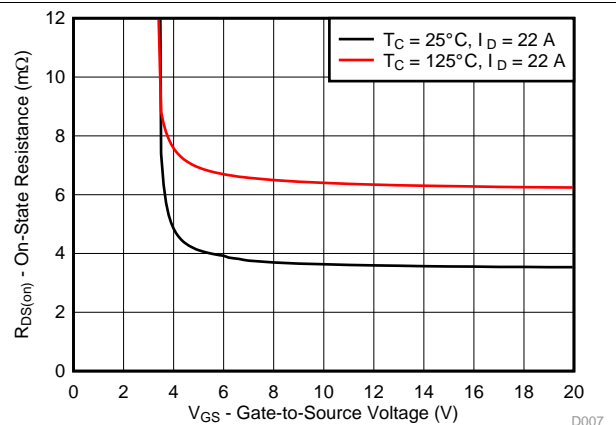
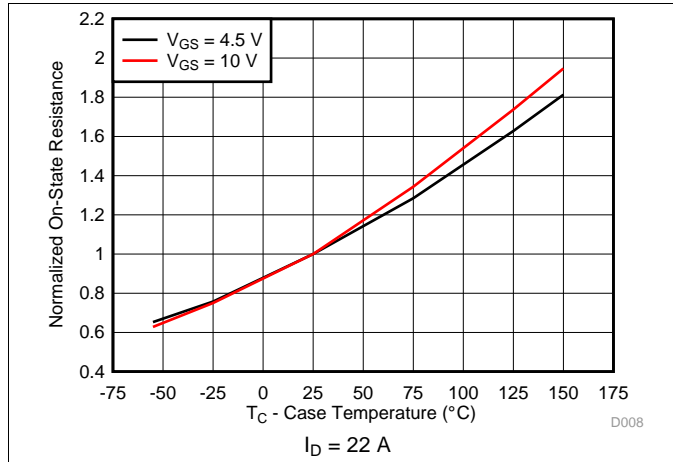

Figure 7. On-State Resistance vs Gate-to-Source Voltage

**Typical MOSFET Characteristics (continued)**

$T_A = 25^\circ\text{C}$  (unless otherwise stated)



**Figure 8. Normalized On-State Resistance vs Temperature**

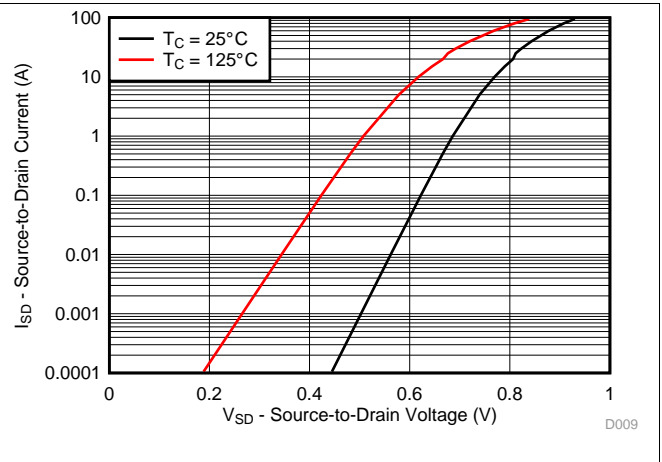

**Figure 9. Typical Diode Forward Voltage**

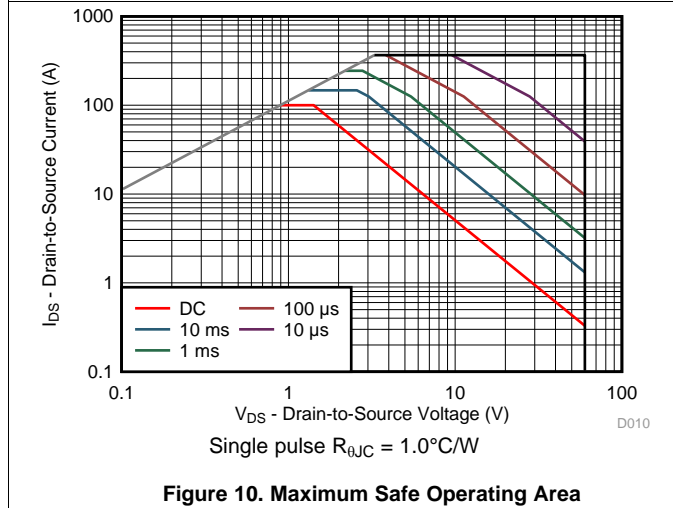

**Figure 10. Maximum Safe Operating Area**

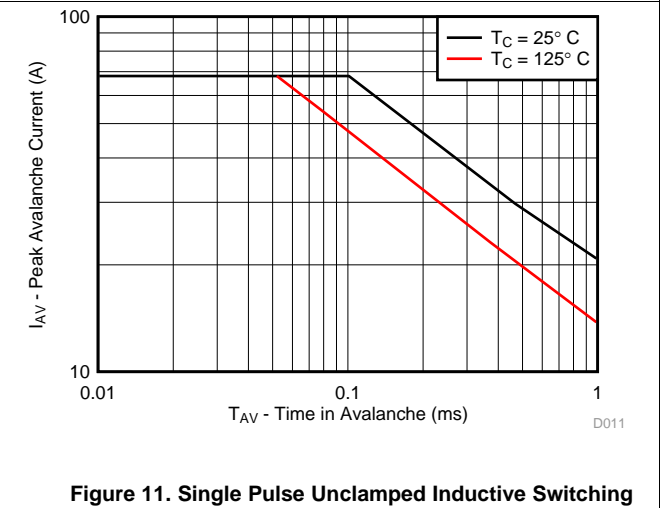

**Figure 11. Single Pulse Unclamped Inductive Switching**

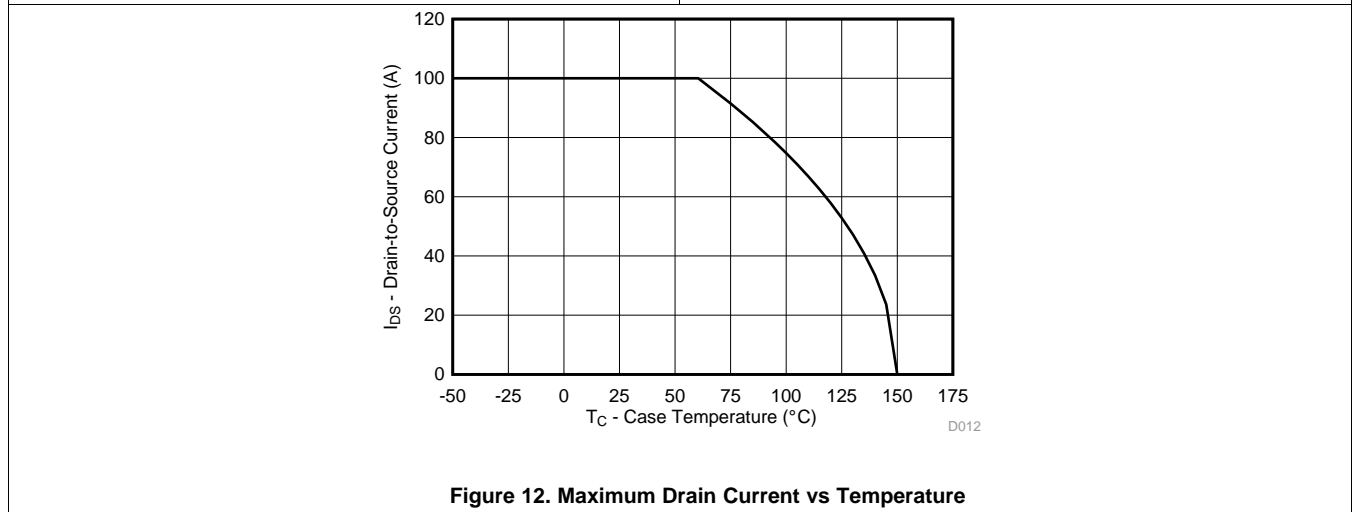

**Figure 12. Maximum Drain Current vs Temperature**

## 6 Device and Documentation Support

### 6.1 Receiving Notification of Documentation Updates

To receive notification of documentation updates, navigate to the device product folder on ti.com. In the upper right corner, click on *Alert me* to register and receive a weekly digest of any product information that has changed. For change details, review the revision history included in any revised document.

### 6.2 Community Resources

The following links connect to TI community resources. Linked contents are provided "AS IS" by the respective contributors. They do not constitute TI specifications and do not necessarily reflect TI's views; see TI's [Terms of Use](#).

**TI E2E™ Online Community** *TI's Engineer-to-Engineer (E2E) Community*. Created to foster collaboration among engineers. At e2e.ti.com, you can ask questions, share knowledge, explore ideas and help solve problems with fellow engineers.

**Design Support** *TI's Design Support* Quickly find helpful E2E forums along with design support tools and contact information for technical support.

### 6.3 Trademarks

NexFET, E2E are trademarks of Texas Instruments.  
All other trademarks are the property of their respective owners.

### 6.4 Electrostatic Discharge Caution



These devices have limited built-in ESD protection. The leads should be shorted together or the device placed in conductive foam during storage or handling to prevent electrostatic damage to the MOS gates.

### 6.5 Glossary

[SLYZ022](#) — *TI Glossary*.

This glossary lists and explains terms, acronyms, and definitions.



## 7 Mechanical Packaging, and Orderable Information

The following pages include mechanical, packaging, and orderable information. This information is the most current data available for the designated devices. This data is subject to change without notice and revision of this document. For browser-based versions of this data sheet, refer to the left-hand navigation.

### 7.1 Q5A Package Dimensions

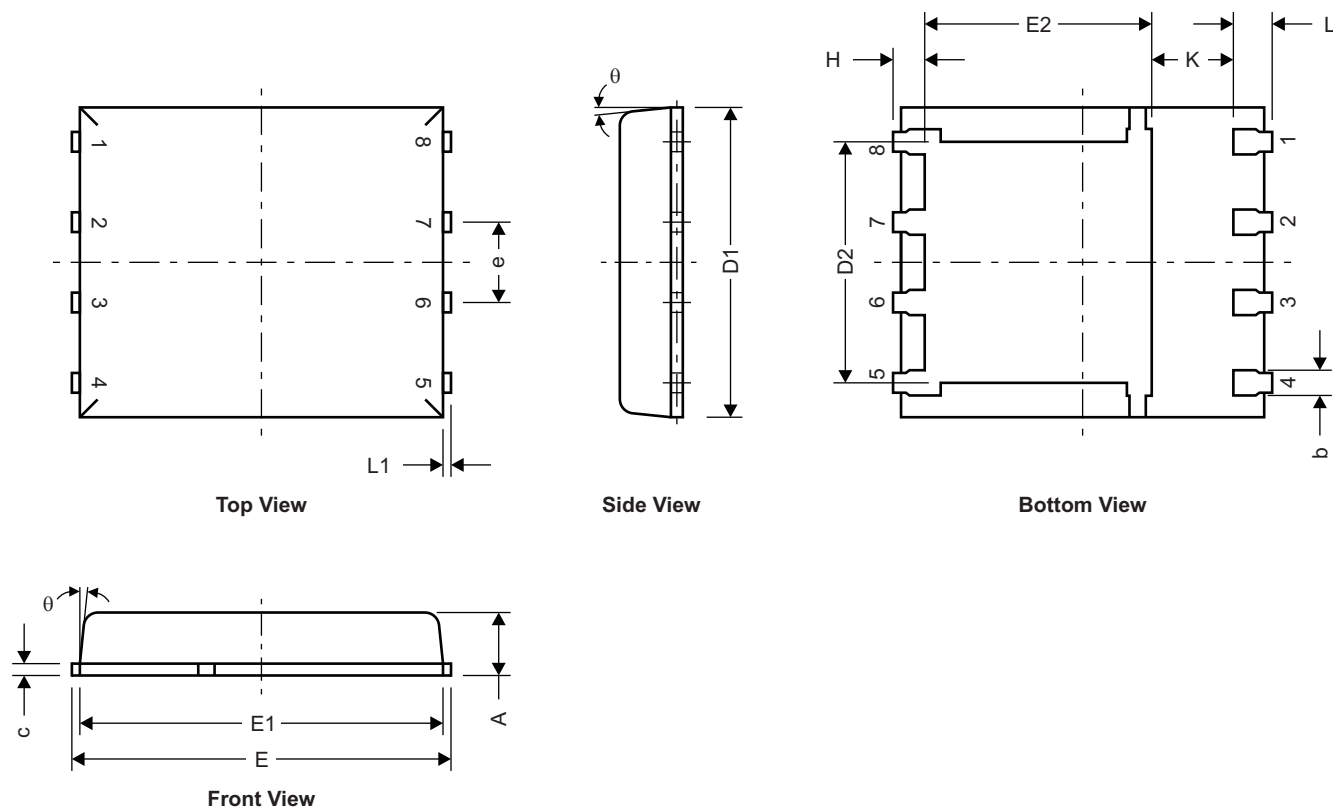

M0135-01

DIM	MILLIMETERS		
	MIN	NOM	MAX
A	0.90	1.00	1.10
b	0.33	0.41	0.51
c	0.20	0.25	0.34
D1	4.80	4.90	5.00
D2	3.61	3.81	4.02
E	5.90	6.00	6.10
E1	5.70	5.75	5.80
E2	3.38	3.58	3.78
e	1.17	1.27	1.37
H	0.41	0.56	0.71
K	1.10	—	—
L	0.51	0.61	0.71
L1	0.06	0.13	0.20
$\theta$	0°	—	12°

### 7.2 Recommended PCB Pattern

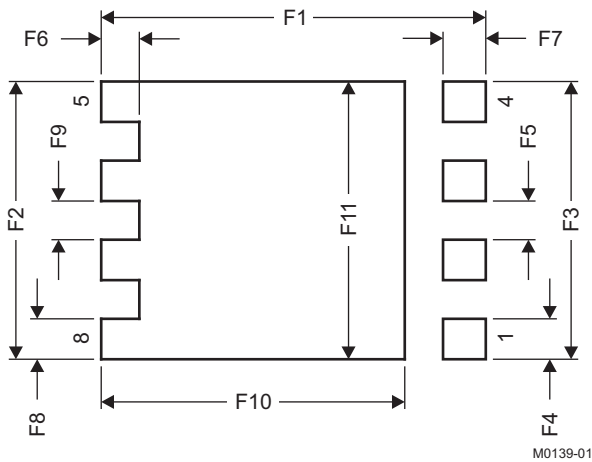

### Recommended PCB Pattern (continued)

DIM	MILLIMETERS		INCHES	
	MIN	MAX	MIN	MAX
F1	6.205	6.305	0.244	0.248
F2	4.46	4.56	0.176	0.18
F3	4.46	4.56	0.176	0.18
F4	0.65	0.7	0.026	0.028
F5	0.62	0.67	0.024	0.026
F6	0.63	0.68	0.025	0.027
F7	0.7	0.8	0.028	0.031
F8	0.65	0.7	0.026	0.028
F9	0.62	0.67	0.024	0.026
F10	4.9	5	0.193	0.197
F11	4.46	4.56	0.176	0.18

For recommended circuit layout for PCB designs, see [Reducing Ringing Through PCB Layout Techniques \(SLPA005\)](#).

### 7.3 Recommended Stencil Opening

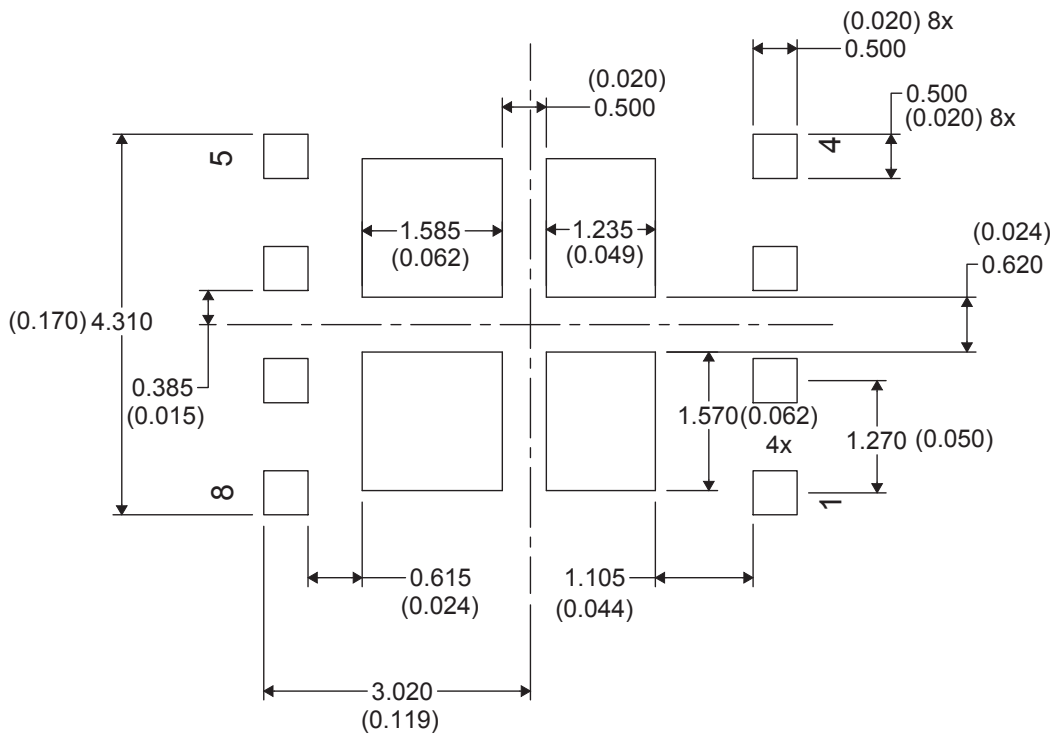

**7.4 Q5A Tape and Reel Information**

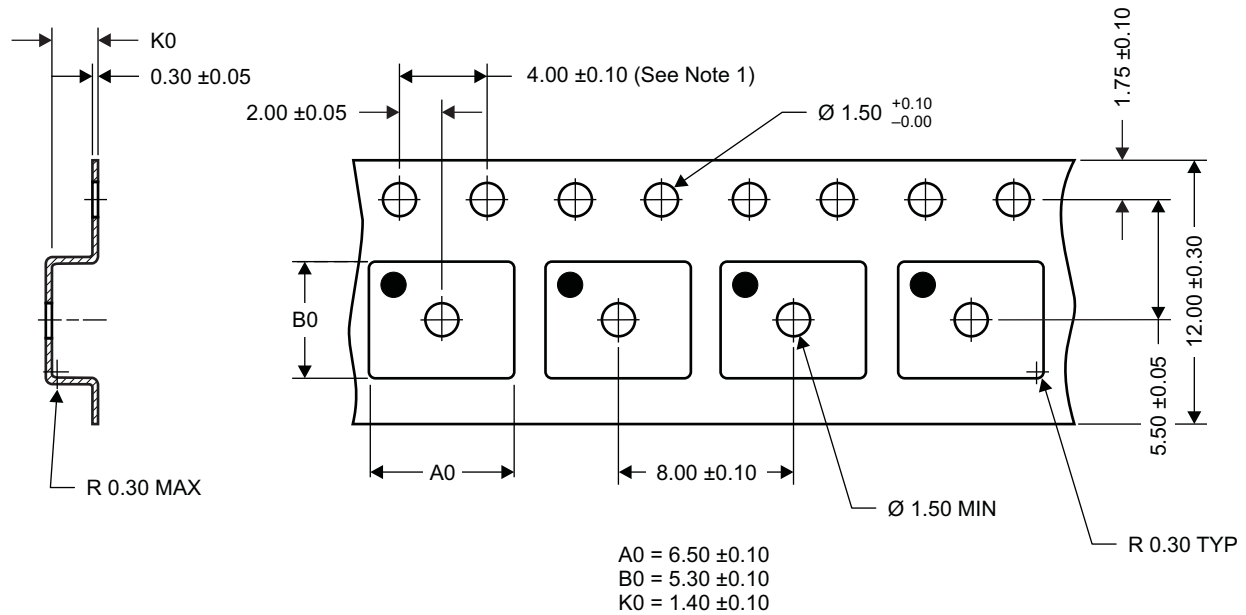



M0138-01

**Notes:**

1. 10 sprocket hole-pitch cumulative tolerance  $\pm 0.2$ .
2. Camber not to exceed 1 mm in 100 mm, noncumulative over 250 mm.
3. Material: black static-dissipative polystyrene.
4. All dimensions are in mm (unless otherwise specified).
5. A0 and B0 measured on a plane 0.3 mm above the bottom of the pocket.

**PACKAGING INFORMATION**

Orderable Device	Status (1)	Package Type	Package Drawing	Pins	Package Qty	Eco Plan (2)	Lead finish/ Ball material (6)	MSL Peak Temp (3)	Op Temp (°C)	Device Marking (4/5)	Samples
CSD18531Q5A	ACTIVE	VSONP	DQJ	8	2500	RoHS-Exempt & Green	SN	Level-1-260C-UNLIM	-55 to 150	CSD18531	
CSD18531Q5AT	ACTIVE	VSONP	DQJ	8	250	RoHS-Exempt & Green	SN	Level-1-260C-UNLIM	-55 to 150	CSD18531	

(1) The marketing status values are defined as follows:

**ACTIVE:** Product device recommended for new designs.

**LIFEBUY:** TI has announced that the device will be discontinued, and a lifetime-buy period is in effect.

**NRND:** Not recommended for new designs. Device is in production to support existing customers, but TI does not recommend using this part in a new design.

**PREVIEW:** Device has been announced but is not in production. Samples may or may not be available.

**OBSOLETE:** TI has discontinued the production of the device.

(2) **RoHS:** TI defines "RoHS" to mean semiconductor products that are compliant with the current EU RoHS requirements for all 10 RoHS substances, including the requirement that RoHS substance do not exceed 0.1% by weight in homogeneous materials. Where designed to be soldered at high temperatures, "RoHS" products are suitable for use in specified lead-free processes. TI may reference these types of products as "Pb-Free".

**RoHS Exempt:** TI defines "RoHS Exempt" to mean products that contain lead but are compliant with EU RoHS pursuant to a specific EU RoHS exemption.

**Green:** TI defines "Green" to mean the content of Chlorine (Cl) and Bromine (Br) based flame retardants meet JS709B low halogen requirements of <=1000ppm threshold. Antimony trioxide based flame retardants must also meet the <=1000ppm threshold requirement.

(3) MSL, Peak Temp. - The Moisture Sensitivity Level rating according to the JEDEC industry standard classifications, and peak solder temperature.

(4) There may be additional marking, which relates to the logo, the lot trace code information, or the environmental category on the device.

(5) Multiple Device Markings will be inside parentheses. Only one Device Marking contained in parentheses and separated by a "~" will appear on a device. If a line is indented then it is a continuation of the previous line and the two combined represent the entire Device Marking for that device.

(6) Lead finish/Ball material - Orderable Devices may have multiple material finish options. Finish options are separated by a vertical ruled line. Lead finish/Ball material values may wrap to two lines if the finish value exceeds the maximum column width.

**Important Information and Disclaimer:**The information provided on this page represents TI's knowledge and belief as of the date that it is provided. TI bases its knowledge and belief on information provided by third parties, and makes no representation or warranty as to the accuracy of such information. Efforts are underway to better integrate information from third parties. TI has taken and continues to take reasonable steps to provide representative and accurate information but may not have conducted destructive testing or chemical analysis on incoming materials and chemicals. TI and TI suppliers consider certain information to be proprietary, and thus CAS numbers and other limited information may not be available for release.

In no event shall TI's liability arising out of such information exceed the total purchase price of the TI part(s) at issue in this document sold by TI to Customer on an annual basis.



## IMPORTANT NOTICE AND DISCLAIMER

TI PROVIDES TECHNICAL AND RELIABILITY DATA (INCLUDING DATASHEETS), DESIGN RESOURCES (INCLUDING REFERENCE DESIGNS), APPLICATION OR OTHER DESIGN ADVICE, WEB TOOLS, SAFETY INFORMATION, AND OTHER RESOURCES "AS IS" AND WITH ALL FAULTS, AND DISCLAIMS ALL WARRANTIES, EXPRESS AND IMPLIED, INCLUDING WITHOUT LIMITATION ANY IMPLIED WARRANTIES OF MERCHANTABILITY, FITNESS FOR A PARTICULAR PURPOSE OR NON-INFRINGEMENT OF THIRD PARTY INTELLECTUAL PROPERTY RIGHTS.

These resources are intended for skilled developers designing with TI products. You are solely responsible for (1) selecting the appropriate TI products for your application, (2) designing, validating and testing your application, and (3) ensuring your application meets applicable standards, and any other safety, security, or other requirements. These resources are subject to change without notice. TI grants you permission to use these resources only for development of an application that uses the TI products described in the resource. Other reproduction and display of these resources is prohibited. No license is granted to any other TI intellectual property right or to any third party intellectual property right. TI disclaims responsibility for, and you will fully indemnify TI and its representatives against, any claims, damages, costs, losses, and liabilities arising out of your use of these resources.

TI's products are provided subject to TI's Terms of Sale ([www.ti.com/legal/termsofsale.html](http://www.ti.com/legal/termsofsale.html)) or other applicable terms available either on [ti.com](http://ti.com) or provided in conjunction with such TI products. TI's provision of these resources does not expand or otherwise alter TI's applicable warranties or warranty disclaimers for TI products.

Mailing Address: Texas Instruments, Post Office Box 655303, Dallas, Texas 75265  
Copyright © 2020, Texas Instruments Incorporated

单击下面可查看定价，库存，交付和生命周期等信息

[>>TI\(德州仪器\)](#)